

редства индивидуальной защиты

Технические характеристики

По вопросам продаж и поддержки обращайтесь:

Алматы (7273)495-231
Ангарск (3955)60-70-56
Архангельск (8182)63-90-72
Астрахань (8512)99-46-04
Барнаул (3852)73-04-60
Белгород (4722)40-23-64
Благовещенск (4162)22-76-07
Брянск (4832)59-03-52
Владивосток (423)249-28-31
Владикавказ (8672)28-90-48
Владимир (4922)49-43-18
Волгоград (844)278-03-48
Вологда (8172)26-41-59
Воронеж (473)204-51-73
Екатеринбург (343)384-55-89

Иваново (4932)77-34-06
Ижевск (3412)26-03-58
Иркутск (395)279-98-46
Казань (843)206-01-48
Калининград (4012)72-03-81
Калуга (4842)92-23-67
Кемерово (3842)65-04-62
Киров (8332)68-02-04
Коломна (4966)23-41-49
Кострома (4942)77-07-48
Краснодар (861)203-40-90
Красноярск (391)204-63-61
Курск (4712)77-13-04
Курган (3522)50-90-47
Липецк (4742)52-20-81

Магнитогорск (3519)55-03-13
Москва (495)268-04-70
Мурманск (8152)59-64-93
Набережные Челны (8552)20-53-41
Нижегород (831)429-08-12
Новокузнецк (3843)20-46-81
Ноябрьск (3496)41-32-12
Новосибирск (383)227-86-73
Омск (3812)21-46-40
Орел (4862)44-53-42
Оренбург (3532)37-68-04
Пенза (8412)22-31-16
Петрозаводск (8142)55-98-37
Псков (8112)59-10-37
Пермь (342)205-81-47

Ростов-на-Дону (863)308-18-15
Рязань (4912)46-61-64
Самара (846)206-03-16
Санкт-Петербург (812)309-46-40
Саратов (845)249-38-78
Севастополь (8692)22-31-93
Саранск (8342)22-96-24
Симферополь (3652)67-13-56
Смоленск (4812)29-41-54
Сочи (862)225-72-31
Ставрополь (8652)20-65-13
Сургут (3462)77-98-35
Сыктывкар (8212)25-95-17
Тамбов (4752)50-40-97
Тверь (4822)63-31-35

Тольятти (8482)63-91-07
Томск (3822)98-41-53
Тула (4872)33-79-87
Тюмень (3452)66-21-18
Ульяновск (8422)24-23-59
Улан-Удэ (3012)59-97-51
Уфа (347)229-48-12
Хабаровск (4212)92-98-04
Чебоксары (8352)28-53-07
Челябинск (351)202-03-61
Череповец (8202)49-02-64
Чита (3022)38-34-83
Якутск (4112)23-90-97
Ярославль (4852)69-52-93

Россия +7(495)268-04-70

Казахстан +7(7172)727-132

Киргизия +996(312)96-26-47

эл.почта: tam@nt-rt.ru || сайт: <https://3m.nt-rt.ru/>



3M™ Secure Click™ Lens Replacement FF-800-01, 5 ea/Case

3M Stock
7100263777

Previous 3M Stock
70071765591

UPC
00638060432136

Alternative ID
FF-800-01



3M™ Speedglas™ 9100 Hard Hat Adapter 06-0014-00NR, for 3M™ Speedglas™ Welding Helmets, No Hard Hat

3M Stock
7100291855

UPC
00638060434772

Alternative ID
06-0014-00NR



3M™ DBI-SALA® Nano-Lok™ Connected Order Picker Self-Retracting Lifeline 2000044, Hook Electronics, Web, 6 ft

3M Stock
7012818207

Previous 3M Stock
2000044

Alternative ID
2000044



3M™ DBI-SALA® D-ring Attachment 0.5" x 2.25" 1500004, 100 EA/PACK

3M Stock
7100214251

Previous 3M Stock
1500004

UPC
00852684930612

Alternative ID
1500004



3M™ DBI-SALA® Perimeter Limiter Leading Edge Anchor 2100090

3M Stock
7100227987

Previous 3M Stock
2100090

UPC
00840779003051

Alternative ID
2100090



3M™ DBI-SALA® Detent Anchor Socket and Cap For Concrete 2101000, Fits 7/8 in Hole

3M Stock
7012818267

Previous 3M Stock
2101000

UPC
00840779011742

Alternative ID
2101000



3M™ Organic Vapor/Acid Gas Cartridge/Filter 60928, P100 60 EA/Case

3M Stock
7000002009
Previous 3M Stock
70070614535
UPC
50051138464702
Alternative ID
60928



3M™ Organic Vapor/Acid Gas Cartridge/Filter 60923, P100, 60 EA/Case

3M Stock
7000029640
Previous 3M Stock
70070614501
UPC
50051138464672
Alternative ID
60923



3M™ Organic Vapor Cartridge/Filter 60921, P100 60 EA/Case

3M Stock
7000029639
Previous 3M Stock
70070614485
UPC
50051138464658
Alternative ID
60921



3M™ Ammonia/Methylamine/Filter 60924, P100, 60 EA/Case

3M Stock
7000051992
Previous 3M Stock
70070614519
UPC
50051138464689
Alternative ID
60924



3M™ Multi Gas/Vapor Cartridge/Filter 60926, P100 60 EA/Case

3M Stock
700002041
Previous 3M Stock
70070709483
UPC
50051138541878
Alternative ID
60926



3M™ Speedglas™ G5-01 Outer Flip-Up Welding Shield w Hinge Mech, Pivot Ring, and Outer Welding Visor Frame, 46-0099-34, 1 ...

3M Stock
7100214378
Previous 3M Stock
70071735719
UPC
00076308944650
Alternative ID
46-0099-34



3M™ Half Facepiece Disposable Respirator Assembly 52P71, Organic Vapor/P95 Respiratory Protection, Medium 12 EA/Case

3M Stock
7000052080
Previous 3M Stock
70070797181
UPC
50051138660692
Alternative ID
52P71



3M™ Versaflo™ Easy Clean Backpack TR-927, 1 Ea/Case

3M Stock
7100300071
Alternative ID
TR-927



3M™ PELTOR™ Hygiene Kit for Earmuffs HYX5/37284(AAD), Hearing Conservation, 10 Kits/Case

3M Stock
7000104049
Previous 3M Stock
XA007707616
UPC
04046719723645
Alternative ID
HYX5



3M™ PELTOR™ Hygiene Kit for Earmuffs HYX4/37283(AAD), Hearing Conservation, 10 Kits/Case

3M Stock
7000104048
Previous 3M Stock
XA007707608
UPC
04046719723591
Alternative ID
HYX4



3M™ DBI-SALA® Adjustable Web Positioning Lanyard 1231022, 8 ft

3M Stock
7100241702
Previous 3M Stock
1231022
UPC
00840779063185
Alternative ID
1231022



3M™ DBI-SALA® Adjustable Rope Positioning Lanyard 1232209, 1/2 in Nylon, 6 ft

3M Stock
7012817067
Previous 3M Stock
1232209
UPC
00648250160909
Alternative ID
1232209



**3M™ DBI-SALA® Adjustable
Web Positioning Lanyard
1231013, 5 ft**

3M Stock
7012817000
Previous 3M Stock
1231013
UPC
00840779040438
Alternative ID
1231013



**3M™ DBI-SALA® Adjustable
Web Positioning Lanyard
1231011, 3 ft**

3M Stock
7100247152
Previous 3M Stock
1231011
UPC
00840779040414
Alternative ID
1231011



**3M™ Organic Vapor Cartridge
6001, 60 EA/Case**

3M Stock
7000051851
Previous 3M Stock
70070316776
UPC
50051138216745
Alternative ID
6001



**3M™ Acid Gas Cartridge 6002,
60 EA/Case**

3M Stock
7000051850
Previous 3M Stock
70070316768
UPC
50051138288803
Alternative ID
6002



**3M™ Organic Vapor/Acid Gas
Cartridge 6003/07047(AAD), 60
EA/Case**

3M Stock
7000051849
Previous 3M Stock
70070316750
UPC
50051131070474
Alternative ID
6003



**3M™ Formaldehyde/Organic
Vapor Cartridge 6005, 60
EA/Case**

3M Stock
7000001936
Previous 3M Stock
70070316735
UPC
50051138288834
Alternative ID
6005



3M™ Ammonia Methylamine Cartridge 6004, 60 EA/Case

3M Stock
7000001937
Previous 3M Stock
70070316743
UPC
5005113828827
Alternative ID
6004



3M™ Mercury Vapor/Organic Vapor/Acid Gas Cartridge 6007, 60 EA/Case

3M Stock
7100198706
UPC
50051131276654
Alternative ID
6007



3M™ Mercury Vapor/Organic Vapor/Acid Gas Cartridge/Filter 60927, P100, 60 EA/Case

3M Stock
7100198708
UPC
50051131276661
Alternative ID
60927



3M™ Multi Gas/Vapor Cartridge 6006, 60 ea/Case

3M Stock
7000002040
Previous 3M Stock
70070709475
UPC
50051138541861
Alternative ID
6006



3M™ BX™ Reader Protective Eyewear 11374-00000-20, Clear Lens, Silver Frame, +1.5 Diopter, 20 ea/Case

3M Stock
7000127490
Previous 3M Stock
70071539566
UPC
10078371620469
Alternative ID
11374-00000-20



3M™ Versaflo™ Standard Visor M-925/37323(AAD), 5 EA/Case

3M Stock
7000127690
Previous 3M Stock
70071562170
UPC
00051131373235
Alternative ID
M-925



**3M™ Nose Cup Assembly
6894/37004(AAD), Replacement
Part 5 EA/Case**

3M Stock
7000002034
Previous 3M Stock
70070709145
UPC
50051131370048
Alternative ID
6894

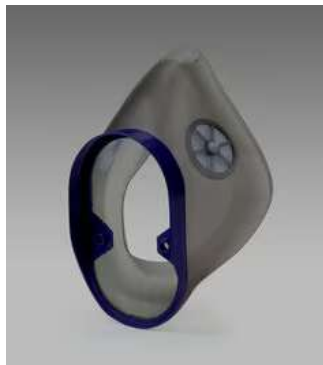

**3M™ Nose Cup Assembly
FF-400-11, 5 EA/Case**

3M Stock
7000052741
Previous 3M Stock
70071516945
UPC
50051135894830
Alternative ID
FF-400-11



**3M™ Versaflo™ Replacement
Visor Frame Assembly
M-920/37320(AAD), 1 EA/Case**

3M Stock
7000127687
Previous 3M Stock
70071562147
UPC
00051131373204
Alternative ID
M-920



**3M™ Secure Click™ Multi-
Gas/Vapor Cartridge/Filter P100
D80926, 60 ea/Case**

3M Stock
7100153234
UPC
00051141566818
Alternative ID
D80926



**3M™ Secure Click™ Organic
Vapor Cartridge/Filter P100
D80921, 60 ea/Case**

3M Stock
7100153232
UPC
00051141566764
Alternative ID
D80921



**3M™ Secure Click™ Organic
Vapor/Acid Gas Cartridge/Filter
P100 D80923, 60 ea/Case**

3M Stock
7100153233
UPC
00051141566788
Alternative ID
D80923



**3M™ Speedglas™ G5-01
Airduct Breathing Tube, with
Holder, 46-0400-57, 1 EA/Case**

3M Stock
7100215556
Previous 3M Stock
70071735602
UPC
00076308944513
Alternative ID
46-0400-57



**3M™ Speedglas™ G5-02
Magnification Plate 08-0500-56,
1.5X**

3M Stock
7100239738
Previous 3M Stock
70071736113
UPC
00076308944445
Alternative ID
08-0500-56



**3M™ Rugged Comfort Quick
Latch Half Facepiece Reusable
Respirator 6501QL/49488,
Small, 10 EA/Case**

3M Stock
7000128237
Previous 3M Stock
70071621828
UPC
50051131494881
Alternative ID
6501QL



**3M™ Rugged Comfort Quick
Latch Half Facepiece Reusable
Respirator 6502QL/49490,
Medium, 10 EA/Case**

3M Stock
7000128239
Previous 3M Stock
70071621844
UPC
50051131494904
Alternative ID
6502QL



**3M™ PELTOR™ X4/X5 Earmuff
Probed Test Cushions
393-3005-2, 2 EA/Case**

3M Stock
7100062128
Previous 3M Stock
70071691136
UPC
00078371668365
Alternative ID
393-3005-2



**3M™ PELTOR™ X3 Earmuff
Probed Test Cushions
393-3003-2, 2 EA/Case**

3M Stock
7100062127
Previous 3M Stock
70071691128
UPC
00078371668358
Alternative ID
393-3003-2



**3M™ PELTOR™ Earmuff
Probed Test Cushion #35,
393-3004-2, 2PR/CS**

3M Stock
7100123728
Previous 3M Stock
70071676285
UPC
10078371670907
Alternative ID
393-3004-2



**3M™ Versaflo™ Forehead
Comfort Pad/Sweat Pad
M-957/L-115/37010(AAD), 10
EA/Case**

3M Stock
7100043088
Previous 3M Stock
70070798577
UPC
00051131370104
Alternative ID
M-957/L-115

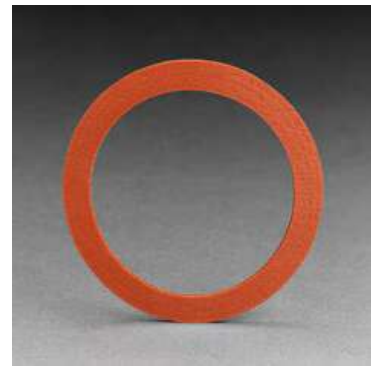

**3M™ Center Adapter Gasket
6896, 20 EA/Case**

3M Stock
7000052122
Previous 3M Stock
70070847051
UPC
50051138766240
Alternative ID
6896



**3M™ Inhalation Port TR-654
Replacement Gaskets for
TR-653 Cleaning and Storage
Kit, 20/Bag, 4 Bags EA/Case**

3M Stock
7000002050
Previous 3M Stock
70070710994
UPC
50051131071457
Alternative ID
6895



**3M™ Secure Click™ Particulate
Filter P95 D7P71, 200 EA/Case**

3M Stock
7100213434
UPC
50051131278108
Alternative ID
D7P71



**3M™ Rugged Comfort 6583 /
55888 Exhalation Valve, System
Component**

3M Stock
7000128253
Previous 3M Stock
70071622412
UPC
00051141558882
Alternative ID
6583



**3M™ Exhalation Valve
6889/07143(AAD), 10 ea/Bag**

3M Stock
7000002057
Previous 3M Stock
70070757656
UPC
50051131071433
Alternative ID
6889



**3M™ Cap Suspension
H-213-2/37117(AAD) 2 EA/Case**

3M Stock
7000126541
Previous 3M Stock
70071093622
UPC
50051131371175
Alternative ID
H-213-2



**3M™ DBI-SALA® Nano-Lok™
edge Personal Self-Retracting
Lifeline 3500293, Galvanized
Cable, 8 ft**

3M Stock
7012828694
UPC
00648250243619
Alternative ID
3500293



**3M™ Secure Click™ Filter
Retainer D701, 100 EA/Case**

3M Stock
7100184498
UPC
50689330179133
Alternative ID
D701



**3M™ Organic Vapor Cartridge
6001, 60 EA/Case**

3M Stock
7000051851
Previous 3M Stock
70070316776
UPC
50051138216745
Alternative ID
6001



**3M™ Acid Gas Cartridge 6002,
60 EA/Case**

3M Stock
7000051850
Previous 3M Stock
70070316768
UPC
50051138288803
Alternative ID
6002



3M™ Organic Vapor/Acid Gas Cartridge 6003/07047(AAD), 60 EA/Case

3M Stock
7000051849
Previous 3M Stock
70070316750
UPC
50051131070474
Alternative ID
6003



3M™ Formaldehyde/Organic Vapor Cartridge 6005, 60 EA/Case

3M Stock
7000001936
Previous 3M Stock
70070316735
UPC
50051138288834
Alternative ID
6005



3M™ Ammonia Methylamine Cartridge 6004, 60 EA/Case

3M Stock
7000001937
Previous 3M Stock
70070316743
UPC
50051138288827
Alternative ID
6004



3M™ Mercury Vapor/Organic Vapor/Acid Gas Cartridge 6007, 60 EA/Case

3M Stock
7100198706
UPC
50051131276654
Alternative ID
6007



3M™ Mercury Vapor/Organic Vapor/Acid Gas Cartridge/Filter 60927, P100, 60 EA/Case

3M Stock
7100198708
UPC
50051131276661
Alternative ID
60927



3M™ Multi Gas/Vapor Cartridge 6006, 60 ea/Case

3M Stock
7000002040
Previous 3M Stock
70070709475
UPC
50051138541861
Alternative ID
6006



3M™ Dual Airline Back-Mounted Adapter Kit SA-2000 1 EA/Case

3M Stock
7000126161
Previous 3M Stock
70070613321
Alternative ID
SA-2000



3M™ Dual Airline Back-Mounted Adapter Kit SA-2000LP, Low Pressure 1 EA/Case

3M Stock
7100010250
Previous 3M Stock
70070613339
Alternative ID
SA-2000LP



3M™ Versaflo™ Forehead Comfort Pad/Sweat Pad M-957/L-115/37010(AAD), 10 EA/Case

3M Stock
7100043088
Previous 3M Stock
70070798577
UPC
00051131370104
Alternative ID
M-957/L-115



3M™ DBI-SALA® Confined Space Aluminum Ladder Section 8518507, 8 ft

3M Stock
7012820786
Previous 3M Stock
8518507
Alternative ID
8518507



3M™ Double Locking Swiveling Snap Hook 9502195, Zinc Plated Steel, 3600 lb Gate, 0.75 in Throat

3M Stock
7100312726
Alternative ID
9502195



3M™ PELTOR™ Professional In Ear Communication Headset PIC-100 NA, 20 ea/Case

3M Stock
7100262767
Previous 3M Stock
70071766359
UPC
00638060433164
Alternative ID
PIC-100 NA



**3M™ DBI-SALA® Nano-Lok™
Connected Extended Length
Order Picker Self-Retracting
Lifeline 2000037, Web, 11 ft**

3M Stock
7100264409
Previous 3M Stock
2000037
UPC
00648250179376
Alternative ID
2000037



**3M™ DBI-SALA® Confined
Space Rescue Davit System
with Winch 8302500, Technora
Rope, 50 ft**

3M Stock
7100231963
UPC
00840779005918
Alternative ID
8302500



**3M™ Virtua™ Sport CCS
Protective Eyewear
11798-00000-20 Corded Control
System, Gray Anti-Fog Lens, 20
EA/Case**

3M Stock
7010384246
Previous 3M Stock
70071561982
UPC
10078371117983
Alternative ID
11798-00000-20



**3M™ Virtua™ Sport CCS
Protective Eyewear
11796-00000-20 Clear Anti-Fog
Lens, 20 EA/Case**

3M Stock
7010340677
Previous 3M Stock
70071561966
UPC
10078371117969
Alternative ID
11796-00000-20



**3M™ DBI-SALA® Rope
Carrying Bag 8700225, PVC
Vinyl, Yellow, 8 in x 7.5 in x 25 in**

3M Stock
7012821057
Previous 3M Stock
8700225
UPC
00648250170519
Alternative ID
8700225



**3M™ DBI-SALA® Flexiguard™
Counterweight Base Hoist Ring
Kit 8530777, 5000 lb, 4 ea/Pack**

3M Stock
7100306797
Previous 3M Stock
8530777
UPC
00648250192948
Alternative ID
8530777



3M™ Protecta® Shock Absorbing Lanyard for Hot Work Use 1340185, 6ft (1.8m), 1 ea

3M Stock
7100218778
Previous 3M Stock
1340185
UPC
00648250173992
Alternative ID
1340185



3M™ DBI-SALA® Rollgliss™ Bucket Truck Rescue Descender 3304001, Polyester Web, 55 ft

3M Stock
7012818864
Previous 3M Stock
3304001



3M™ DBI-SALA® Rollgliss™ Anchorage Plate For Rescue Ladder 8516316

3M Stock
7012595693
Previous 3M Stock
8516316
UPC
00840779006267
Alternative ID
8516316



3M™ DBI-SALA® Assisted Rescue Web Pick-Off Strap 1200174, 4 ft

3M Stock
7100268008
Previous 3M Stock
1200174
UPC
00840779147670
Alternative ID
1200174



3M™ Secure Click™ Full Facepiece Reusable Respirator FF-803, Large, 4 EA/Case

3M Stock
7100261328
UPC
00638060432297
Alternative ID
FF-803



3M™ Secure Click™ Full Facepiece Reusable Respirator FF-802, Medium, 4 EA/Case

3M Stock
7100261326
UPC
50638060432285
Alternative ID
FF-802



**3M™ DBI-SALA® Rollgliss™
Rescue Pole 8900298, Silver
and Red, 4 ft. to 16 ft. (1.2 to 4.9
m)**

3M Stock
7100226854
UPC
00840779106929
Alternative ID
8900298



**3M™ DBI-SALA® FlexiGuard™
M200 Jack Stabilizing, 8530907,
1Kit**

3M Stock
7100296911
Previous 3M Stock
8530907
Alternative ID
8530907



**3M™ Speedglas™ Heavy-Duty
Welding Helmet G5-01, Rigid
Neck Cover, Fabric Head Cover,
No ADF, 46-0099-35, 1 EA/Case**

3M Stock
7100259574
UPC
00638060433393
Alternative ID
46-0099-35



**3M™ Secure Click™ Head
Harness Assembly for HF-800
Series Respirators with
Speaking Diaphragm,
HF-800-04, 5 EA/Case**

3M Stock
7100217704
UPC
04054596787810
Alternative ID
HF-800-04



**3M™ Head Harness Assembly
6281, 20 EA/Case**

3M Stock
7000029677
Previous 3M Stock
70070846087
UPC
50051138765670
Alternative ID
6281



**3M™ Head Harness FF-400-04,
5 EA/Case**

3M Stock
7100003369
Previous 3M Stock
70071516879
UPC
50051135894762
Alternative ID
FF-400-04



**3M™ Head Harness Assembly
7581, System Component 20
EA/Case**

3M Stock
7000002157
Previous 3M Stock
70071042603
UPC
50051131527534
Alternative ID
7581



**3M™ Rugged Comfort 6582 /
55887 Quick Latch Head
Harness Assembly, System
Component**

3M Stock
7000128252
Previous 3M Stock
70071622404
UPC
50051141558870
Alternative ID
6582



**3M™ Head Harness FF-800-05,
5 ea/Case**

3M Stock
7100283489
Previous 3M Stock
70071766730
UPC
00638060433645
Alternative ID
FF-800-05



**3M™ Head Harness
6897/37005(AAD), 5 EA/Case**

3M Stock
7000002035
Previous 3M Stock
70070709152
UPC
50051131370055
Alternative ID
6897



**3M™ Advanced Particulate Filter
2297, P100, with Nuisance Level
Organic Vapor Relief, 100
EA/Case**

3M Stock
7000127451
Previous 3M Stock
70071533973
UPC
50051131171720
Alternative ID
2297



**3M™ Advanced Particulate Filter
2291, P100 100 EA/Case**

3M Stock
7000127449
Previous 3M Stock
70071533957
UPC
50051131171706
Alternative ID
2291



3M™ Particulate Filter 2091/07000(AAD), P100 100 EA/Case

3M Stock
7000051991
Previous 3M Stock
70070614410
UPC
50051131070009
Alternative ID
2091



3M™ Particulate Filter 2078, P95, with Nuisance Level Organic Vapor/Acid Gas Relief 100 EA/Case

3M Stock
7000052066
Previous 3M Stock
70070757904
UPC
50051138543681
Alternative ID
2078



3M™ Particulate Filter 2096, P100, with Nuisance Level Acid Gas Relief 100 EA/Case

3M Stock
7000002048
Previous 3M Stock
70070710937
UPC
50051138542950
Alternative ID
2096



3M™ Particulate Filter 2071, P95 100 EA/Case

3M Stock
7000002058
Previous 3M Stock
70070757680
UPC
50051138543568
Alternative ID
2071



3M™ Hydrogen Fluoride Cartridge/Filter 7093CB, P100, with Nuisance Level Organic Vapor and Acid Gas Relief 144 EA/Case

3M Stock
7000126938
Previous 3M Stock
70071401270
UPC
50051131919704
Alternative ID
7093CB



3M™ Particulate Cartridge 2076HF, Hydrogen Fluoride, P95, with Nuisance Level Acid Gas Relief 100 EA/Case

3M Stock
7000021310
Previous 3M Stock
70070757912
UPC
50051138543698
Alternative ID
2076HF



3M™ Hydrogen Fluoride Cartridge/Filter 7093C, P100, with Nuisance Level Organic Vapor and Acid Gas Relief, 60 EA/Case

3M Stock
7000052600
Previous 3M Stock
70071401262
UPC
50051131371731
Alternative ID
7093C



3M™ Particulate Filter 2097/07184(AAD), P100, with Nuisance Level Organic Vapor Relief 100 EA/Case

3M Stock
7000029657
Previous 3M Stock
70070710945
UPC
50051131071846
Alternative ID
2097



3M™ Particulate Filter 7093B, P100 144 EA/Case

3M Stock
7000002155
Previous 3M Stock
70071042231
UPC
50051131527060
Alternative ID
7093B



3M™ Particulate Filter 7093, P100 60 EA/Case

3M Stock
7000002154
Previous 3M Stock
70071042223
UPC
50051131527053
Alternative ID
7093



3M™ BX™ Reader Protective Eyewear 11374-00000-20, Clear Lens, Silver Frame, +1.5 Diopter, 20 ea/Case

3M Stock
7000127490
Previous 3M Stock
70071539566
UPC
10078371620469
Alternative ID
11374-00000-20



3M™ Micro D-ring Cord Tool Attachment Point 1500010, 2 lb Capacity, 10 ea/Pack

3M Stock
7012599294
UPC
00852684933422
Alternative ID
1500010



3M™ DBI-SALA® D-ring Attachment 1" x 3.5" 1500008, 50 EA/PACK

3M Stock
7100214254
Previous 3M Stock
1500008
UPC
00852684930711
Alternative ID
1500008



3M™ DBI-SALA® Quick Wrap Tape II 1500168, Blue 1"x108"

3M Stock
7100204329
Previous 3M Stock
1500168
UPC
00840779151301
Alternative ID
1500168



3M™ DBI-SALA® Quick Spin Large Size 1500029, 10 EA/Pack

3M Stock
7100210212
Previous 3M Stock
1500029
UPC
00852684932609
Alternative ID
1500029



3M™ DBI-SALA® Quick Wrap Tape II 1500174, Yellow 1"x108"

3M Stock
7100204330
Previous 3M Stock
1500174
UPC
00840779151363
Alternative ID
1500174



3M™ Small Quick Spin Tool Attachment Point 1500027, 1 lb Capacity, 0.6 in, 10 ea/Pack

3M Stock
7100239364
Previous 3M Stock
1500027
UPC
00852684932777
Alternative ID
1500027



3M™ Small Quick Ring Tool Attachment Point 1500024, 2 lb Capacity, 0.75 in, 25 ea/Pack

3M Stock
7100311174
Previous 3M Stock
1500024
UPC
00852684932562
Alternative ID
1500024



3M™ Dual Wing Cinch Tool
Attachment Point 1500018, 80 lb
Capacity, 10 ea/Pack

3M Stock
7100310176
Previous 3M Stock
1500018
UPC
00852684934603
Alternative ID
1500018



3M™ Dual Wing Cinch Tool
Attachment Point 1500016, 35 lb
Capacity, 10 ea/Pack

3M Stock
7012689168
Previous 3M Stock
1500016
UPC
00852684932982
Alternative ID
1500016



3M™ Single Wing Cinch Tool
Attachment Point 1500014, 35 lb
Capacity, 10 ea/Pack

3M Stock
7100310175
Previous 3M Stock
1500014
UPC
00852684932944
Alternative ID
1500014

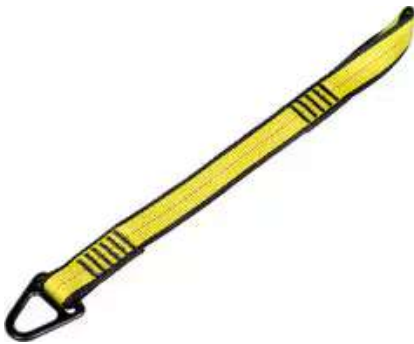

3M™ Cinch Tool Attachment
Point 1500012, 35 lb Capacity,
10 ea/Pack

3M Stock
7100275355
Previous 3M Stock
1500012
UPC
00852684933026
Alternative ID
1500012



3M™ DBI-SALA® Quick Wrap
Tape II 1500170, Blue 1"x108",
120/PAC

3M Stock
7100204962
Previous 3M Stock
1500170
UPC
00840779151325
Alternative ID
1500170



3M™ Heat Shrink Tool
Attachment Point 1500023, 3 in
x 4 in, 10 ea/Pack

3M Stock
7100316896
Previous 3M Stock
1500023
UPC
00852684932128
Alternative ID
1500023



**3M™ DBI-SALA® Quick Wrap
Tape II 1500173, Blue 1"x216",
60/PAC**

3M Stock
7100204963

Previous 3M Stock
1500173

Alternative ID
1500173



**3M™ Heat Shrink Tool
Attachment Point 1500021, 1.5
in x 2 in, 25 ea/Pack**

3M Stock
7012818079

Previous 3M Stock
1500021

UPC
00852684932029

Alternative ID
1500021



**3M™ DBI-SALA® Quick Wrap
Tape II 1500172, Blue 1"x216",
10 EA/PACK**

3M Stock
7100214239

Previous 3M Stock
1500172

UPC
00840779151349

Alternative ID
1500172



**3M™ DBI-SALA® Quick Wrap
Tape II 1500176, Yellow, 1"x
108", 120 ea/Pack**

3M Stock
7100217324

Previous 3M Stock
1500176

UPC
00840779151387

Alternative ID
1500176



**3M™ Permanent Marker Quick
Spin Tool Attachment Point
1500033, 1 lb Capacity, 0.5 in,
10 ea/Pack**

3M Stock
7100242311

Previous 3M Stock
1500033

UPC
00852684932708

Alternative ID
1500033



**3M™ DBI-SALA® Quick Wrap
Tape II 1500175, Yellow, 1"x
108", 10 EA/PACK**

3M Stock
7100217304

Previous 3M Stock
1500175

UPC
00840779151370

Alternative ID
1500175



**3M™ DBI-SALA® Quick Spin
X-Large Size 1500030, 10
EA/Pack**

3M Stock
7100210233
Previous 3M Stock
1500030
UPC
00852684932791
Alternative ID
1500030



**3M™ DBI-SALA® Quick Spin
Medium Size 1500028, 10
EA/Pack**

3M Stock
7100210211
Previous 3M Stock
1500028
UPC
00852684932623
Alternative ID
1500028



**3M™ DBI-SALA® D-Ring
Attachment 1" x 3.5" 1500007,
10 EA/Pack**

3M Stock
7100210210
UPC
00852684930698
Alternative ID
1500007



**3M™ DBI-SALA® Quick Ring
1.50" 1500026, 25 ea/Pack**

3M Stock
7100223420
Previous 3M Stock
1500026
UPC
00852684932586
Alternative ID
1500026



**3M™ DBI-SALA® D-ring
Attachment 0.5" x 2.25" Non-
Conductive 1500006, 100
EA/PACK**

3M Stock
7100214253
Previous 3M Stock
1500006
UPC
00852684930650
Alternative ID
1500006



**3M™ Heat Shrink Tool
Attachment Point 1500022, 2 in
x 4 in, 10 ea/Pack**

3M Stock
7100239363
Previous 3M Stock
1500022
UPC
00852684932098
Alternative ID
1500022



3M™ DBI-SALA® D-ring Attachment 0.5" x 2.25" Non-Conductive 1500005, 10 EA/PACK

3M Stock
7100214252
Previous 3M Stock
1500005
UPC
00852684930674
Alternative ID
1500005



3M™ DBI-SALA® Heat Shrink 1" x 1.75" 1500020, 25 ea/Pack

3M Stock
7100220231
Previous 3M Stock
1500020
UPC
00852684932074
Alternative ID
1500020



3M™ Heat Shrink Tool Attachment Point 1500019, 0.75 in x 1.75 in, 25 ea/Pack

3M Stock
7100241915
Previous 3M Stock
1500019
UPC
00852684932005
Alternative ID
1500019



3M™ DBI-SALA® Quick Wrap Tape II 1500169, Blue 1"x108", 10/PAC

3M Stock
7100204961
UPC
00840779151318
Alternative ID
1500169



3M™ DBI-SALA® Dual D-ring Attachment 1500001, Small, 10 EA/PACK

3M Stock
7100214248
Previous 3M Stock
1500001
UPC
00852684930599
Alternative ID
1500001



3M™ Permanent Marker Quick Spin with Coil Tool Attachment Point 1500034, 1 lb Capacity, 0.5 in, 10 ea/Pack

3M Stock
7100310224
Previous 3M Stock
1500034
UPC
00852684932746
Alternative ID
1500034



3M™ Hook2Quick-Ring Coil Tool Tether 1500066, 2 lb Capacity, 3 - 62 in, 10 ea/Pack

3M Stock
7100312707
Previous 3M Stock
1500066
UPC
00852684931008
Alternative ID
1500066



3M™ Pen Holder Quick Spin with Coil Tool Attachment Point 1500032, 1 lb Capacity, 0.3 in, 10 ea/Pack

3M Stock
7100310223
Previous 3M Stock
1500032
UPC
00852684932678
Alternative ID
1500032



3M™ Pen Holder Quick Spin Tool Attachment Point 1500031, 1 lb Capacity, 0.3 in, 10 ea/Pack

3M Stock
7100241872
Previous 3M Stock
1500031
UPC
00852684932647
Alternative ID
1500031



3M™ DBI-SALA® Fixed Ladder Self-Retracting Lifeline Anchor Tagline 6100566, Stainless Steel

3M Stock
7100260187
Previous 3M Stock
6100566
UPC
00840779192779
Alternative ID
6100566



3M™ Secure Click™ Half Facepiece Reusable Respirator with Speaking Diaphragm HF-803SD, Large, 10 ea/Case

3M Stock
7100172000
UPC
04054596595125
Alternative ID
HF-803SD



3M™ Secure Click™ Half Facepiece Reusable Respirator with Speaking Diaphragm HF-802SD, Medium, 10 ea/Case

3M Stock
7100172051
UPC
04054596595095
Alternative ID
HF-802SD



3M™ Secure Click™ Half Facepiece Reusable Respirator with Speaking Diaphragm HF-801SD, Small, 10 ea/Case

3M Stock
7100172045
UPC
04054596595064
Alternative ID
HF-801SD

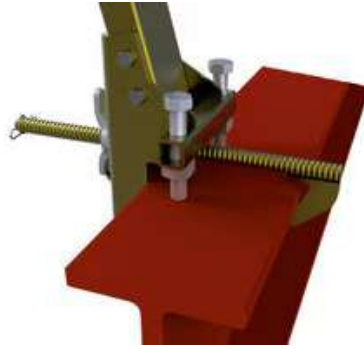

3M™ DBI-SALA® Temporary I-Beam Horizontal Lifeline Stanchion Base 7400052, Fits 6 - 12 in Flange Up To 2.25 in Thick

3M Stock
7012820226
Previous 3M Stock
7400052
UPC
00840779004737
Alternative ID
7400052



3M™ DBI-SALA® Nano-Lok™ Single-Pin Style SRL Connector for Single-leg or Twin-leg 3100480

3M Stock
7100230460
Previous 3M Stock
3100480
UPC
00840779188390
Alternative ID
3100480



3M™ DBI-SALA® Nano-Lok™ Dual-Pin Style SRL Connector for Single-leg or Twin-leg 3100483

3M Stock
7100230462
Previous 3M Stock
3100483
UPC
00840779188420
Alternative ID
3100483



3M™ X5-P4PTCS1 Premium 4 Point Chin Strap with magnetic buckle for SecureFit™ Safety Helmet

3M Stock
7100207541
Previous 3M Stock
UU010328167
UPC
50076308944976
Alternative ID
X5-P4PTCS1



3M™ Elastic Chin Strap X24, 46551-00000 10 EA/Case

3M Stock
7000029947
Previous 3M Stock
70071513314
UPC
10078371465510
Alternative ID
46551-00000



3M™ Standard 4-Point Chin Strap with Buckle and Selector for SecureFit™ Safety Helmet X5000 Series X5-S4PTCS2, 10 EA/Case

3M Stock
7100175587

Previous 3M Stock
UU009536036

UPC
04054596595439

Alternative ID
X5-S4PTCS2



3M™ Premium 4-Point Chin Strap with Magnetic Buckle and Selector for SecureFit™ Safety Helmet X5000 Series X5-P4PTCS2, 10 EA/Case

3M Stock
7100175589

Previous 3M Stock
UU009536051

UPC
04054596595507

Alternative ID
X5-P4PTCS2



3M™ DBI-SALA® Lad-Saf™ Mobile Rope Grab 5000335, 1 EA

3M Stock
7100204313

UPC
00840779001255

Alternative ID
5000335



3M™ DBI-SALA® SSB Cable Climb Assist System Lifeline Assembly 3512180, 1/4 in Galvanized Steel 7 x 19, 180 ft

3M Stock
7012819334

UPC
00840779071333

Alternative ID
3512180



3M™ DBI-SALA® SSB Cable Climb Assist System Lifeline Assembly 3530200, 1/4 in Stainless Steel 7 x 19, 200 ft

3M Stock
7012819383

UPC
00840779169801

Alternative ID
3530200



3M™ DBI-SALA® Uni-Anchor with Tie-Off for Inclined Surface 8517413, 1/CV

3M Stock
7100188844

UPC
00840779009015

Alternative ID
8517413



3M™ Protecta® Reusable Hinged Roof Anchor For Wood/Metal 2104000, with Fastener Kit

3M Stock
7012818304
Previous 3M Stock
2104000
UPC
00840779146574
Alternative ID
2104000



3M™ DBI-SALA® Lad-Saf™ Detachable Cable Traveller 6160030, 1 EA

3M Stock
7100188818
UPC
00648250167922
Alternative ID
6160030



3M™ DBI-SALA® Adjustable Web Positioning Lanyard for Nano-Lok™ SRL 1231075, 6 ft

3M Stock
7012691245
Previous 3M Stock
1231075
UPC
00648250168080
Alternative ID
1231075



3M™ DBI-SALA® Nano-Lok™ Aerial Work Platform Personal Self-Retracting Lifeline 3101655, Web, 4.5 ft

3M Stock
7012818760
Previous 3M Stock
3101655
UPC
00840779153312
Alternative ID
3101655



3M™ DBI-SALA® Flexiguard™ Jib Counterweight Base with Concrete 8530566, Yellow, 5000 lb

3M Stock
7100231986
UPC
00648250170045
Alternative ID
8530566



3M™ DBI-SALA® Coated Web Scaffold Choker Anchor 1201422, Polyester, 2 ft

3M Stock
7012816943
Previous 3M Stock
1201422
UPC
00840779036660
Alternative ID
1201422



3M™ PELTOR™ CH-5 High Attenuation Headset - MT73H450A-77 GB - Flex Connector - Headband - 31dB NRR

3M Stock
7100099844

UPC
07318640067059

Alternative ID
MT73H450A-77 GB



3M™ E-A-R™ One Touch™ Pro Earplug Dispenser, Blue 391-0000

3M Stock
7100064963

Previous 3M Stock
70071674207

UPC
00078371668037

Alternative ID
391-0000



3M™ DBI-SALA® Lad-Saf™ Flexible Counterweight 5901583, 1 ea

3M Stock
7100220276

Previous 3M Stock
5901583

UPC
00840779003570

Alternative ID
5901583



3M™ Secure Click™ Quantitative Fit Test Adapter Kit FF-800-06, 1 ea/Case

3M Stock
7100265593

Previous 3M Stock
70071765724

UPC
00638060432266

Alternative ID
FF-800-06



3M™ Secure Click™ Quantitative Fit Test Adapter Kit HF-800-03, 1 EA/Case

3M Stock
7100181558

UPC
04054596622012

Alternative ID
HF-800-03



3M™ DBI-SALA® Confined Space Integrated Tank Flange Davit Mast Base 8520267, Fits 18 - 36 in dia

3M Stock
7100244490

Previous 3M Stock
8520267

UPC
00840779009060

Alternative ID
8520267



3M™ DBI-SALA® Confined Space Integrated Vehicle Hitch Mount Sleeve Extension Tube 8512829, Zinc Plated Steel, 4 ft

3M Stock
7012820615
Previous 3M Stock
8512829
Alternative ID
8512829



3M™ DBI-SALA® Confined Space Integrated Vehicle Hitch Mount Sleeve Extension Tube 8511384, Zinc Plated Steel, 6 ft

3M Stock
7012820549
Previous 3M Stock
8511384
Alternative ID
8511384



3M™ DBI-SALA® Confined Space Integrated Vehicle Hitch Mount Sleeve Extension Tube 8514503, Zinc Plated Steel, 2 ft

3M Stock
7012820657
Previous 3M Stock
8514503
Alternative ID
8514503



3M™ DBI-SALA® SecuraSpan™ Rebar/Shear Stud HLL Tie-Back Base with Chain 7400214, 1 ea

3M Stock
7100220279
Previous 3M Stock
7400214
UPC
00840779004799
Alternative ID
7400214



3M™ DBI-SALA® Sealed-Blok™ Assisted Rescue Pole/Tool for RSQ Self-Retracting Lifeline 3500202, 8 - 16 ft

3M Stock
7100239633
Previous 3M Stock
3500202
UPC
00840779002092
Alternative ID
3500202



3M™ Versaflo™ Cleaning & Storage Kit BT-953, for BT-63/64 Breathing Tubes 1/case

3M Stock
7100176699
UPC
00051131277557
Alternative ID
BT-953



**3M™ Versaflo™ Standard Visor
M-925/37323(AAD), 5 EA/Case**

3M Stock
7000127690
Previous 3M Stock
70071562170
UPC
00051131373235
Alternative ID
M-925



**3M™ DBI-SALA® Rescue Rope
Grab For Web 5000032,
Stainless Steel**

3M Stock
7100316906
Previous 3M Stock
5000032
Alternative ID
5000032



**3M™ DBI-SALA® Confined
Space Portable Extendable Pole
Hoist 8560409, Stainless Steel
Hardware, 4 ft - 7 ft**

3M Stock
7100311854
Previous 3M Stock
8560409
Alternative ID
8560409



**3M™ Center Adapter Gasket
6896, 20 EA/Case**

3M Stock
7000052122
Previous 3M Stock
70070847051
UPC
50051138766240
Alternative ID
6896



**3M™ Inhalation Port TR-654
Replacement Gaskets for
TR-653 Cleaning and Storage
Kit, 20/Bag, 4 Bags EA/Case**

3M Stock
7000002050
Previous 3M Stock
70070710994
UPC
50051131071457
Alternative ID
6895



**3M™ DBI-SALA® Confined
Space 4-in-1 Davit Guard
System 8530352, 1 EA**

3M Stock
7100204296
Previous 3M Stock
8530352
UPC
00840779013821
Alternative ID
8530352



**3M™ DBI-SALA® Beam Trolley
2103143, 1 EA**

3M Stock
7100188831
Previous 3M Stock
2103143
UPC
00840779000647
Alternative ID
2103143



**3M™ Organic Vapor/Acid Gas
Cartridge/Filter 60928, P100 60
EA/Case**

3M Stock
7000002009
Previous 3M Stock
70070614535
UPC
50051138464702
Alternative ID
60928



**3M™ Organic Vapor/Acid Gas
Cartridge/Filter 60923, P100, 60
EA/Case**

3M Stock
7000029640
Previous 3M Stock
70070614501
UPC
50051138464672
Alternative ID
60923



**3M™ Organic Vapor
Cartridge/Filter 60921, P100 60
EA/Case**

3M Stock
7000029639
Previous 3M Stock
70070614485
UPC
50051138464658
Alternative ID
60921



**3M™ Ammonia/
Methylamine/Filter 60924, P100,
60 EA/Case**

3M Stock
7000051992
Previous 3M Stock
70070614519
UPC
50051138464689
Alternative ID
60924



**3M™ Multi Gas/Vapor
Cartridge/Filter 60926, P100 60
EA/Case**

3M Stock
7000002041
Previous 3M Stock
70070709483
UPC
50051138541878
Alternative ID
60926



**3M™ DBI-SALA® D-ring
Anchorage Plate 2101638, 1 ea**

3M Stock
7100217031
Previous 3M Stock
2101638
UPC
00840779008346
Alternative ID
2101638



**3M™ DBI-SALA® D-ring
Anchorage Plate 2101632, 1 EA**

3M Stock
7100217032
Previous 3M Stock
2101632
UPC
00840779047284
Alternative ID
2101632



**3M™ DBI-SALA® D-ring with
Anchorage Plate 2101630, 1 EA**

3M Stock
7100188830
Previous 3M Stock
2101630
UPC
00840779000630
Alternative ID
2101630



**3M™ DBI-SALA® Vacuum
Anchor Lifeline System without
Air Bottle Attachment 2200107**

3M Stock
7100228423
Previous 3M Stock
2200107
UPC
00648250166147
Alternative ID
2200107



**3M™ DBI-SALA® Aviation Self-
Contained Vacuum Anchor with
Air Bottle 2200108, Shop Air or
Gas Powered**

3M Stock
7100307766
Previous 3M Stock
2200122
UPC
00840779070220
Alternative ID
2200122



**3M™ DBI-SALA® Vacuum
Anchor with Air Bottle
Attachment 2200095**

3M Stock
7100228431
Previous 3M Stock
2200095
UPC
00648250161449
Alternative ID
2200095



3M™ DBI-SALA® Vacuum Anchor Lifeline System without Air Bottle Attachment 2200094

3M Stock
7100228430
Previous 3M Stock
2200094
UPC
00648250161432
Alternative ID
2200094



3M™ Speedglas™ 9100 QR w Rail only, 06-0300-54QR, 1 EA/CASE

3M Stock
7100200569
UPC
00076308943752
Alternative ID
06-0300-54QR



3M™ DBI-SALA® D-ring Bolt Anchor For Concrete 2104563, 1 Extra Bolts, Fits 11/16 in, 18 mm or 3/4 in Hole

3M Stock
7012818330
Previous 3M Stock
2104563
UPC
00840779067190
Alternative ID
2104563



3M™ DBI-SALA® D-ring Bolt Anchor For Concrete 2104562, 11 Extra Bolts, Fits 11/16 in, 18 mm or 3/4 in Hole

3M Stock
7012818329
Previous 3M Stock
2104562
UPC
00648250162507
Alternative ID
2104562



3M™ DBI-SALA® Concrete D-ring Anchor 2104560, 1 EA

3M Stock
7100188834
Previous 3M Stock
2104560
UPC
00840779002337
Alternative ID
2104560



3M™ DBI-SALA® Concrete D-ring Anchor, 5 Extra Bolts 2104561, 1 pack

3M Stock
7100217043
Previous 3M Stock
2104561
UPC
00648250162491
Alternative ID
2104561



3M™ DBI-SALA® Pass-Thru Web Concrete Strap Anchor with D-ring 2100058, Polyester, 10 ft

3M Stock
7012818240
Previous 3M Stock
2100058
UPC
00840779047185
Alternative ID
2100058



3M™ DBI-SALA® Concrete Anchor Strap 2100053

3M Stock
7100232041
Previous 3M Stock
2100053
UPC
00076308400460
Alternative ID
2100053



3M™ DBI-SALA® Pass-Thru Web Concrete Strap Anchor with D-Ring 2100050, Polyester, 3.5 ft

3M Stock
7100260185
Previous 3M Stock
2100050
UPC
00648250160466
Alternative ID
2100050



3M™ DBI-SALA® Pass-Thru Web Concrete Strap Anchor with D-ring 2100054, Polyester, 5 ft

3M Stock
7012818238
Previous 3M Stock
2100054
UPC
00840779047161
Alternative ID
2100054



3M™ DBI-SALA® Pass-Thru Web Concrete Strap Anchor with D-ring 2100052, Polyester, 8 ft

3M Stock
7012818236
Previous 3M Stock
2100052
UPC
00840779047154
Alternative ID
2100052



3M™ DBI-SALA® Pass-Thru Web Concrete Strap Anchor with D-ring 2100088, Polyester, 2 ft

3M Stock
7012818244
Previous 3M Stock
2100088
Alternative ID
2100088



**3M™ Solus™ 1000 Series
S1000-CASE, Carrying Case, 10
ea/Box**

3M Stock
7100228822

Previous 3M Stock
70071734043

UPC
50638060429483

Alternative ID
S1000-CASE



**3M™ Speedglas™ G5-01
Battery Holder, 44-0400-55, 1
EA/Case**

3M Stock
7100214393

Previous 3M Stock
70071735891

UPC
00076308944834

Alternative ID
44-0400-55



**3M™ Speedglas™ 9100
FX/9100 FX-Air Front Panel
06-0700-63, Chrome, 1 EA/Case**

3M Stock
7000128084

Previous 3M Stock
70071606357

UPC
00051131496798

Alternative ID
06-0700-63



**3M™ Speedglas™ 9100
FX/9100 FX-Air Wide-View
Grinding Visor Frame
06-0700-64, Black, 1 EA/Case**

3M Stock
7100089205

Previous 3M Stock
70071668746

UPC
00051141564012

Alternative ID
06-0700-64



**3M™ Speedglas™ G5-02
Welding Helmet Front Cover
08-0700-63, 1 ea**

3M Stock
7100239739

Previous 3M Stock
70071736048

UPC
00076308944377

Alternative ID
08-0700-63



**3M™ Speedglas™ Silver Front
Panel 9100XXi, Welding Safety
06-0300-55i 1 EA/Case**

3M Stock
7010386337

UPC
00051141563282



3M™ Virtua™ CCS Protective Eyewear with Foam Gasket, VC220AF Clear +2.0D Anti-Fog Lens, 20 ea/Case

3M Stock
7100046672
Previous 3M Stock
70071654092
UPC
10078371662704
Alternative ID
VC220AF



3M™ DBI-SALA® Vacuum Anchor Lifeline System Secondary Pad 2200096

3M Stock
7100228412
Previous 3M Stock
2200096
UPC
00648250161456
Alternative ID
2200096



3M™ DBI-SALA® Vacuum Anchor Lifeline System Secondary Pad Vacuum Anchor 2200109

3M Stock
7100226832
Previous 3M Stock
2200109
UPC
00840779000982
Alternative ID
2200109



3M™ DBI-SALA® Confined Space Integrated Adjustable Barrel Mount Sleeve 8512285, Fits Up To 24 in

3M Stock
7100260213
Previous 3M Stock
8512285
UPC
00840779006083
Alternative ID
8512285



3M™ Half Facepiece Disposable Respirator Assembly 52P71, Organic Vapor/P95 Respiratory Protection, Medium 12 EA/Case

3M Stock
7000126246
Previous 3M Stock
70070797868
UPC
00051131071926
Alternative ID
52P71



3M™ Cartridge Filter Holder 7586, 20 EA/Case

3M Stock
7000002160
Previous 3M Stock
70071042637
UPC
50051131527565
Alternative ID
7586



**3M™ Rugged Comfort 6583 /
55888 Exhalation Valve, System
Component**

3M Stock
7000128253
Previous 3M Stock
70071622412
UPC
00051141558882
Alternative ID
6583



**3M™ Exhalation Valve
6889/07143(AAD), 10 ea/Bag**

3M Stock
7000002057
Previous 3M Stock
70070757656
UPC
50051131071433
Alternative ID
6889



**3M™ Versaflo™ Filter Cover
TR-6500FC, for TR-6500 Series
Cartridges, 1 EA/Case**

3M Stock
7100021252
Previous 3M Stock
70071622073
Alternative ID
TR-6500FC



**3M™ Versaflo™ Filter Cover
TR-6300FC/37380 (AAD), for
TR-6300 Series Cartridges, 1
EA/Case**

3M Stock
7100021336
Previous 3M Stock
70071622065
Alternative ID
TR-6300FC



**3M™ Versaflo™ Filter Cover
TR-6800FC/37378(AAD), for
TR-6820N Filter, 1 EA/Case**

3M Stock
7100021247
Previous 3M Stock
70071622040
Alternative ID
TR-6800FC



**3M™ Versaflo™ High
Temperature Breathing Tube
Cover BT-926/L-199SG, 1
EA/Case**

3M Stock
7000052729
Previous 3M Stock
70071516556
UPC
00051135894514
Alternative ID
BT-926/L-199SG



**3M™ DBI-SALA® Flexiguard™
M100 Modular Jib Fork Pocket
Kit 8530911**

3M Stock
7100314339
Previous 3M Stock
8530911
Alternative ID
8530911



**3M™ PELTOR™ X4/X5 Earmuff
Probed Test Cushions
393-3005-2, 2 EA/Case**

3M Stock
7100062128
Previous 3M Stock
70071691136
UPC
00078371668365
Alternative ID
393-3005-2



**3M™ PELTOR™ X3 Earmuff
Probed Test Cushions
393-3003-2, 2 EA/Case**

3M Stock
7100062127
Previous 3M Stock
70071691128
UPC
00078371668358
Alternative ID
393-3003-2



**3M™ PELTOR™ Earmuff
Probed Test Cushion #35,
393-3004-2, 2PR/CS**

3M Stock
7100123728
Previous 3M Stock
70071676285
UPC
10078371670907
Alternative ID
393-3004-2



**3M™ PELTOR™ Welding
Earmuff H505B, Behind-the-
Head, 10 EA/Case**

3M Stock
7000103840
Previous 3M Stock
XA007704639
UPC
10093045936400
Alternative ID
H505B



**3M™ DBI-SALA® Confined
Space Winch/Self-Retracting
Lifeline Mounting Bracket For
Davit Mast 8549915**

3M Stock
7100245940
UPC
00840779197408
Alternative ID
8549915



3M™ Protecta® Mounting Bracket For 3-Way Retrieval Self-Retracting Lifeline 3590499, SRL Side Only

3M Stock
7100309559
Previous 3M Stock
3590499
UPC
00840779100095
Alternative ID
3590499



3M™ DBI-SALA® Flexiguard™ Supported Ladder Rail Fixed Height Access Anchor System 8530397, 2 User, 9 ft High, 3 ft Wide

3M Stock
7100325589
Previous 3M Stock
70007499018
UPC
00840779107940
Alternative ID
8530397



3M™ DBI-SALA® Temporary Fasten-In-Place Horizontal Lifeline Clamp-On Vertical Base For Concrete/Steel 8530373

3M Stock
7100245937
Previous 3M Stock
8530373
UPC
00840779169832
Alternative ID
8530373



3M™ DBI-SALA® SecuraSpan™ Fasten-in-Place HLL Bolt-on Vertical Base 7400218, 1 ea

3M Stock
7100220280
Previous 3M Stock
7400218
UPC
00840779013128
Alternative ID
7400218



3M™ DBI-SALA® SecuraSpan™ Fasten-in-Place HLL Bolt-on Floor Base 8530267, 1 ea

3M Stock
7100220318
Previous 3M Stock
8530267
UPC
00840779013180
Alternative ID
8530267



3M™ DBI-SALA® SecuraSpan™ Fasten-in-Place HLL Clamp-on Vertical Base 7400211, 1 ea

3M Stock
7100220278
Previous 3M Stock
7400211
UPC
00840779013111
Alternative ID
7400211



3M™ PROTECTA® Retrieval Self Retracting Lifeline Mounting Bracket, SRL Side and Tripod Base, 3590498

3M Stock
7100230834

Previous 3M Stock
3590498

UPC
00648250169179

Alternative ID
3590498



3M™ DBI-SALA® Rollgliss™ Sealed Tension Limiter For Man-Riding Systems 3601490, Stainless Steel Cable, 23 ft

3M Stock
7012693284

Previous 3M Stock
3601490

UPC
00840779073979

Alternative ID
3601490



3M™ Self-Retracting Lifeline Retrieval Mounting Bracket 3401140, Zinc Plated Steel, 130 ft

3M Stock
7100311177

Previous 3M Stock
3401140

Alternative ID
3401140



3M™ Self-Retracting Lifeline Retrieval Mounting Bracket 3401123, Zinc Plated Steel, 85 ft

3M Stock
7100311176

Previous 3M Stock
3401123

Alternative ID
3401123



3M™ Self-Retracting Lifeline Retrieval Mounting Bracket 3401065, Zinc Plated Steel, 50 ft

3M Stock
7100311175

Previous 3M Stock
3401065

UPC
00648250160855

Alternative ID
3401065



3M™ Protecta® Mounting Bracket For 3-Way Retrieval Self-Retracting Lifeline 3590497, SRL Side Only

3M Stock
7012819400

Previous 3M Stock
3590497

UPC
00648250170953

Alternative ID
3590497



3M™ Protecta® Self-Retracting Lifeline Cover 3590011, Fits 50 ft Standard and 33 ft Leading Edge Models

3M Stock
7100263465
Previous 3M Stock
3590011
UPC
00840779141371
Alternative ID
3590011



3M™ Protecta® Self-Retracting Lifeline Cover 3590010, Fits 20 - 33 ft Standard Models

3M Stock
7100257883
Previous 3M Stock
3590010
UPC
00840779141364
Alternative ID
3590010



3M™ DBI-SALA® Nano-Lok™ Cab Mount Bracket Hardware 3100271, 1 ea

3M Stock
7100217571
Previous 3M Stock
3100271
UPC
00840779103393
Alternative ID
3100271



3M™ DBI-SALA® Ultra-Lok™ Assisted Rescue Pole/Tool for RSQ Self-Retracting Lifeline 3500101, 6 - 12 ft

3M Stock
7012819168
Previous 3M Stock
3500101
Alternative ID
3500101



3M™ Protecta® Equipment Carrying and Storage Bag for 8 ft Tripod AK067A

3M Stock
7100252135
Previous 3M Stock
AK067A
UPC
00648250110904
Alternative ID
AK067A



3M™ Protecta® Equipment Carrying and Storage Bag AK066A, 9.5 in x 10 in x 15.5 in

3M Stock
7012822285
Previous 3M Stock
AK066A
Alternative ID
AK066A



**3M™ PELTOR™ ProTac III
MT13H221A, Headset, Black,
Headband, 10 Each/Case**

3M Stock
7100088424

Previous 3M Stock
UU004690622

UPC
04054596123229

Alternative ID
MT13H221A



**3M™ E-A-R Caps™ Model 200
Hearing Protector 321-2101, 100
EA/Case**

3M Stock
7000052716

Previous 3M Stock
70071514833

UPC
10080529210019

Alternative ID
321-2101

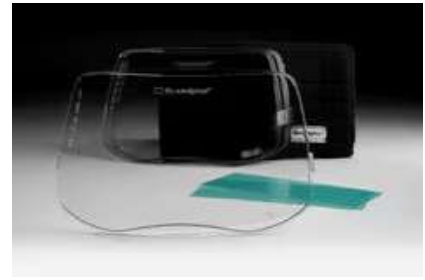

**3M™ Speedglas™ Welding
Starter Kit 9100V 06-0201-10, 1
EA/Case**

3M Stock
7010341130

UPC
00051141561981

Alternative ID
06-0201-10



**3M™ Reusable Nylon Respirator
Storage Bag FF-400-25 10
EA/Case**

3M Stock
7000052878

Previous 3M Stock
70071562345

UPC
50051131173380

Alternative ID
FF-400-25



**3M™ Respirator Replacement
Strap 7580 40 EA/Bag**

3M Stock
7000127455

Previous 3M Stock
70071534294

UPC
50051131172239

Alternative ID
7580



**3M™ Frame Kit
6899/37007(AAD), 5 EA/Case**

3M Stock
7100001832

Previous 3M Stock
70070709178

UPC
50051131370079

Alternative ID
6899



3M™ DBI-SALA® Temporary I-Beam Horizontal Lifeline Stanchion Intermediate Bracket 7400008

3M Stock
7100314307
Previous 3M Stock
7400008
UPC
00840779004706
Alternative ID
7400008

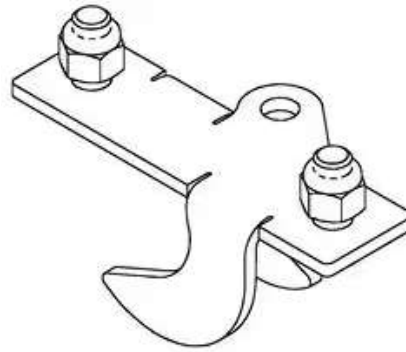

3M™ DBI-SALA® SecuraSpan™ Perpendicular I-Beam HLL Stanchion Intermediate Bracket 7400089, Order Separately, 1 ea

3M Stock
7100220292
Previous 3M Stock
7400089
UPC
00648250173930
Alternative ID
7400089



3M™ DBI-SALA® EZ-Line™ Retractable Horizontal Lifeline System 7605060, 1 EA

3M Stock
7100188820
UPC
00840779002375
Alternative ID
7605060



3M™ DBI-SALA® Nano-Lok™ Twin-Leg Self-Retracting Lifeline with Quick Connect 3100617, Web, Wrap Back, 8 ft.

3M Stock
7012818584
Previous 3M Stock
3100617
UPC
00648250243183
Alternative ID
3100617



3M™ DBI-SALA® Nano-Lok™ Self-Retracting Lifeline with Quick Connect 3100618, Web, Wrap Back, 8 ft.

3M Stock
7012818585
Previous 3M Stock
3100618
UPC
00648250243190
Alternative ID
3100618



3M™ PELTOR™ Earmuff Assembly M-985/37333(AAD), for Versaflo™ M-100 and M-300 Products, Pair, 1 EA/Case

3M Stock
7100004873
Previous 3M Stock
70071562287
Alternative ID
37333



3M™ PELTOR™ X3 Earmuffs X3A/37272(AAD), Over-the-Head, 10 EA/Case

3M Stock
7000104072

Previous 3M Stock
XA007707855

UPC
10093045937254

Alternative ID
X3A



3M™ PELTOR™ X3 Earmuffs X3P5E, Electrically Insulated, Hard Hat Attached, 10 ea/Case

3M Stock
7100097405

Previous 3M Stock
UU007830977

UPC
10078371671027

Alternative ID
X3P5E



3M™ PELTOR™ X3 Earmuffs X3P3E/37277(AAD), Hard Hat Attached, 10 EA/Case

3M Stock
7000104077

Previous 3M Stock
XA007707905

UPC
10093045937308

Alternative ID
X3P3E



3M™ Versaflor™ High Durability Hood with Integrated Head Suspension S-533L, Medium/Large, 1 EA/Case

3M Stock
7000052767

Previous 3M Stock
70071533213

UPC
00051131170872

Alternative ID
S-533L



3M™ Elevated Temperature Aluminum Front Helmet Cover, FC1-AL, Silver, 60 EA/Case

3M Stock
7100082486

Previous 3M Stock
UU003718200

UPC
04054596088276

Alternative ID
FC1-AL



3M™ Clear Polycarbonate Faceshield V2C-10P 10 ea/Case

3M Stock
7000103812

Previous 3M Stock
XA007704134

UPC
10093045936202

Alternative ID
V2C-10P



3M™ DBI-SALA® Wedge Grip Horizontal Lifeline Termination Device 7608008

3M Stock
7012820345
Previous 3M Stock
7608008
UPC
00840779003921
Alternative ID
7608008



3M™ DBI-SALA® Rope Adjustable Positioning Lanyard, Trigger, 1234088

3M Stock
7100157053
Previous 3M Stock
1234088
UPC
00840779162253
Alternative ID
1234088



3M™ DBI-SALA® Rope Adjustable Positioning Lanyard, Trigger, 1234086

3M Stock
7100157034
Previous 3M Stock
1234086
UPC
00840779162239
Alternative ID
1234086



3M™ DBI-SALA® Rope Adjustable Positioning Lanyard, Trigger, 1234087

3M Stock
7100157043
Previous 3M Stock
1234087
UPC
00840779162246
Alternative ID
1234087



3M™ DBI-SALA® Rope Adjustable Positioning Lanyard, Trigger, 1234084

3M Stock
7100157049
Previous 3M Stock
1234084
UPC
00840779162215
Alternative ID
1234084



3M™ DBI-SALA® Rope Adjustable Positioning Lanyard, Trigger, 1234085

3M Stock
7100157040
Previous 3M Stock
1234085
UPC
00840779162222
Alternative ID
1234085



3M™ Safety and Inspection Manager Software, Basic Unlimited Fall Protection

3M Stock
6100003184
Previous 3M Stock
70999987236
Alternative ID
SIM-BASIC



3M™ PELTOR™ Hygiene Kit for Optime™ III Earmuffs, HY54

3M Stock
7000108016
UPC
07318640033801



3M™ PELTOR™ Optime™ 101 Earmuff Hygiene Kit HY7, 20 KT/Case

3M Stock
7000009662
Previous 3M Stock
XH001651062
UPC
04046719416615
Alternative ID
HY7



3M™ PELTOR™ Hygiene Kit for Optime™ I Ear Muffs, HY51

3M Stock
7000039638
Previous 3M Stock
XH001651476
UPC
07318640033788



3M™ DBI-SALA® Fixed Beam Anchor 2108406, 1 EA

3M Stock
7100188829
Previous 3M Stock
2108406
UPC
00840779000685
Alternative ID
2108406



3M™ Speedglas™ G5-01 Pivot Knob, 46-0400-58, 1 EA/Case

3M Stock
7100215096
Previous 3M Stock
70071697257
UPC
00076308944957
Alternative ID
46-0400-58



3M™ Speedglas™ G5-01 Pivot and Sliding Mechanism 46-0400-52, Including Pivot Knobs, 1 ea/Case

3M Stock
7100289276
Previous 3M Stock
70071767555
UPC
00638060434802
Alternative ID
46-0400-52



3M™ Center Adapter Assembly 6864/37000(AAD), 5 EA/Case

3M Stock
7000002178
Previous 3M Stock
70071093010
UPC
50051131370000
Alternative ID
6864



3M™ Inhalation Valve 6893/07144(AAD), System Component 200 EA/Case

3M Stock
7000002049
Previous 3M Stock
70070710986
UPC
50051131071440
Alternative ID
6893



3M™ Secure Click™ Inhalation Valve Assembly FF-800-03, 10 ea/Case

3M Stock
7100265540
Previous 3M Stock
70071765617
Alternative ID
FF-800-03



3M™ Inhalation Valve 7582, Replacement Part 10 EA/Bag

3M Stock
7000002158
Previous 3M Stock
70071042611
UPC
50051131527541
Alternative ID
7582



3M™ Adapter V-199/37069(AAD) 4 EA/Case

3M Stock
7000002156
Previous 3M Stock
70071042512
UPC
00051131370692
Alternative ID
V-199



3M™ DBI-SALA® Temporary Rebar/Shear Stud Horizontal Lifeline End-Anchor Retro-Fit Kit
7400053

3M Stock
701282027
Previous 3M Stock
7400053
UPC
00840779004744
Alternative ID
7400053



3M™ DBI-SALA® Web D-ring Extension Anchor 1231305, Polyester, 1.58 ft

3M Stock
7100260184
Previous 3M Stock
1231305
UPC
00840779010745
Alternative ID
1231305



3M™ DBI-SALA® Adjustable Web Positioning Lanyard 1231022, 8 ft

3M Stock
7100241702
Previous 3M Stock
1231022
UPC
00840779063185
Alternative ID
1231022



3M™ DBI-SALA® Adjustable Rope Positioning Lanyard 1232209, 1/2 in Nylon, 6 ft

3M Stock
7012817067
Previous 3M Stock
1232209
UPC
00648250160909
Alternative ID
1232209



3M™ DBI-SALA® Adjustable Web Positioning Lanyard 1231013, 5 ft

3M Stock
7012817000
Previous 3M Stock
1231013
UPC
00840779040438
Alternative ID
1231013



3M™ DBI-SALA® Adjustable Web Positioning Lanyard 1231011, 3 ft

3M Stock
7100247152
Previous 3M Stock
1231011
UPC
00840779040414
Alternative ID
1231011



3M™ DBI-SALA® Reusable Freestanding Counterweight Roof Top Anchor Lifting Sling Kit
2104190

3M Stock
7100314286

Previous 3M Stock
2104190

UPC
00648250173237

Alternative ID
2104190



3M™ DBI-SALA® ShockWave™ Arc Flash 100% Tie-Off Stretch Web Shock-Absorbing Lanyard
1246525, 6 ft

3M Stock
7100302294

UPC
00648250241127

Alternative ID
1246525



3M™ DBI-SALA® EZ-Stop™ Arc Flash 100% Tie-Off Stretch Web Shock-Absorbing Lanyard
1246526, Kevlar® Fiber, 6 ft

3M Stock
7012817317

Previous 3M Stock
1246526

Alternative ID
1246526



3M™ DBI-SALA® EZ-Stop™ Arc Flash Stretch Web Shock-Absorbing Lanyard
1246518, Kevlar® Fiber, 6 ft

3M Stock
7012817310

Previous 3M Stock
1246518

Alternative ID
1246518



3M™ DBI-SALA® EZ-Stop™ Arc Flash 100% Tie-Off Stretch Web Shock-Absorbing Lanyard
1246527, Kevlar® Fiber, 6 ft

3M Stock
7012817319

Alternative ID
1246527



3M™ DBI-SALA® EZ-Stop™ Arc Flash 100% Tie-Off Web Loop Stretch Web Shock-Absorbing Lanyard
1246529, Kevlar® Fiber, 6 ft

3M Stock
7012817321

Previous 3M Stock
1246529

Alternative ID
1246529



**3M™ DBI-SALA® EZ-Stop™
Arc Flash 100% Tie-Off Stretch
Web Shock-Absorbing Lanyard
1246530, Kevlar® Fiber, 6 ft**

3M Stock
7012817323
Previous 3M Stock
1246530
Alternative ID
1246530



**3M™ DBI-SALA® EZ-Stop™
Arc Flash Web Loop Stretch
Web Shock-Absorbing Lanyard
1246519, Kevlar® Fiber, 6 ft**

3M Stock
7012817312
Previous 3M Stock
1246519
Alternative ID
1246519



**3M™ DBI-SALA® EZ-Stop™
Arc Flash Stretch Web Shock-
Absorbing Lanyard 1246524,
Kevlar® Fiber, 6 ft**

3M Stock
7012817315
Previous 3M Stock
1246524
Alternative ID
1246524



**3M™ PROTECTA® Rope
Lifeline 5/8 in. (1.6 cm) Nylon
with Carabiner AC215A1, 15M**

3M Stock
7100188815
Previous 3M Stock
AC215A1
UPC
00648250030950



**3M™ Secure Click™ Particulate
Filter P100 with Nuisance Level
Acid Gas Relief D3096, 100
ea/Case**

3M Stock
7100213425
UPC
50051131278153
Alternative ID
D3096



**3M™ Secure Click™ Particulate
Filter P100 D3091, 100 EA/Case**

3M Stock
7100213359
UPC
50051131278146
Alternative ID
D3091



3M™ Secure Click™ Particulate Filter P100 with Nuisance Level Organic Vapor Relief D3097, 100 ea/Case
 3M Stock
 7100213150
 UPC
 50051131278160
 Alternative ID
 D3097



3M™ Secure Click™ Hard Case P100 Particulate Filter D9093C, Hydrogen Fluoride and Nuis. Level OV/AG Relief, 60 ea/Case
 3M Stock
 7100206890
 UPC
 50689330191579
 Alternative ID
 D9093C



3M™ Secure Click™ Hard Case P100 Particulate Filter D9093, 60 ea/Case
 3M Stock
 7100206894
 UPC
 50689330191562
 Alternative ID
 D9093



3M™ Secure Click™ Particulate Filter P95 D3071, 100 EA/Case
 3M Stock
 7100213358
 UPC
 50051131278115
 Alternative ID
 D3071



3M™ Particulate Filter 5P71/07194(AAD), P95 100 EA/Case
 3M Stock
 7000002054
 Previous 3M Stock
 70070757417
 UPC
 50051131071945
 Alternative ID
 5P71



3M™ Particulate Filter 5N11, N95 100 EA/Case
 3M Stock
 7000002008
 Previous 3M Stock
 70070614477
 UPC
 50051138464641
 Alternative ID
 5N11



**3M™ PELTOR™ CH-3 Headset
with PTT Headband
MT74H52A-111, FLX2, 10
ea/Case**

3M Stock
7100203638

UPC
04054596695672

Alternative ID
MT74H52A-111



**3M™ PELTOR™ CH-3 Headset
with PTT MT74H52P3E-111,
Hard Hat Attached, FLX2, 1
ea/Case**

3M Stock
7100203150

UPC
04054596695757

Alternative ID
MT74H52P3E-111



**3M™ Speedglas™ G5-01 Large
Comfort Head Rest, 46-0400-55,
1 EA/Case**

3M Stock
7100215553

Previous 3M Stock
70071735768

UPC
00076308944711

Alternative ID
46-0400-55



**3M™ Speedglas™ G5 Series
Standard Head Rest
46-0400-53, 1/Bag**

3M Stock
7100241171

Previous 3M Stock
70071734423

UPC
00638060430088

Alternative ID
46-0400-53



**3M™ DBI-SALA® Comfort
Shoulder Pad For Harness
9502006, Hook and Loop**

3M Stock
7010595610

Previous 3M Stock
9502006

UPC
00840779007264

Alternative ID
9502006



**3M™ DBI-SALA® Comfort
Shoulder/Back Pad For Harness
9501207, Universal**

3M Stock
7012821172

Previous 3M Stock
9501207

UPC
00840779001934

Alternative ID
9501207



**3M™ DBI-SALA® Ultra-Lok™
RSQ Self-Retracting Lifeline
3503888, Galvanized Cable, 50
ft**

3M Stock
7012819275
Previous 3M Stock
3503888
UPC
00648250241387
Alternative ID
3503888



**3M™ DBI-SALA® Ultra-Lok™
RSQ Self-Retracting Lifeline
3503889, Stainless Steel Cable,
50 ft**

3M Stock
7012819276
Previous 3M Stock
3503889
UPC
00648250241394
Alternative ID
3503889



**3M™ Protecta® Mobile Rope
Grab 5000003, Fits 5/8 in Rope**

3M Stock
7012819598
Previous 3M Stock
5000003
UPC
00840779007745
Alternative ID
5000003



**3M™ DBI-SALA® Flexiguard™
Counterweight Base Hoist Ring
Kit 8530914, 5000 lb, 4 ea/Pack**

3M Stock
7100314341
Previous 3M Stock
8530914
Alternative ID
8530914



**3M™ Speedglas™ G5-01
Airduct Breathing Tube, with
Holder, 46-0400-57, 1 EA/Case**

3M Stock
7100215556
Previous 3M Stock
70071735602
UPC
00076308944513
Alternative ID
46-0400-57



**3M™ PELTOR™ Hygiene Kit for
FM Radio, ProTac, & LiteCom
Headsets, HY79**

3M Stock
7100063118
Previous 3M Stock
XH001651047
UPC
07318640011779
Alternative ID
HY79



3M™ DBI-SALA® Metal Horizontal Lifeline Energy Absorber with Hardware Kit 7600580, 3 Shackles, Turnbuckle, Cable Clips, W...

3M Stock
7100314308
Previous 3M Stock
7600580
UPC
00840779005369
Alternative ID
7600580



3M™ DBI-SALA® Metal Horizontal Lifeline Energy Absorber with Hardware Kit 7401032, 2 Shackles, Turnbuckle

3M Stock
7012820256
Previous 3M Stock
7401032
UPC
00840779005017
Alternative ID
7401032



3M™ Double Locking Snap Hook 9502116, Zinc Plated Steel, 3600 lb Gate, 0.75 in Throat

3M Stock
7100310338
Previous 3M Stock
9502116
Alternative ID
9502116



3M™ DBI-SALA® Rope Tagline 7211858, 3/16 in Polypropylene, 35 ft

3M Stock
7100263248
UPC
00840779081028
Alternative ID
7211858



3M™ Speedglas™ G5-02 Curved Auto Darkening Filter 08-0000-50iC, 1 ea/Case

3M Stock
7100243649
Previous 3M Stock
70071736089
UPC
00076308944414
Alternative ID
08-0000-50iC



3M™ Adflo™ Powered Air Purifying Respirator Suspenders, 15-0099-17, 1 EA/Case

3M Stock
7100215094
Previous 3M Stock
70071736030
UPC
00076308944940
Alternative ID
15-0099-17



**3M™ DBI-SALA®
Rescue/Retrieval Web Loop
Wristlets 1001210, 2 ft**

3M Stock
7012815084
Previous 3M Stock
1001210
UPC
00840779001408
Alternative ID
1001210



**3M™ Versaflo™ M-Series Inner
Collar M-444, for use with all
M-Series Outer Shrouds, 1
EA/Case**

3M Stock
7000127683
Previous 3M Stock
70071562089
UPC
00051131173255
Alternative ID
M-444



**3M™ 1100 Probed Test
Earplugs 393-2010-50, 10
Pair/Bag, 5 Bags/Case, 50
Pair/Case**

3M Stock
7000002409
Previous 3M Stock
70071577772
UPC
10080529190878
Alternative ID
393-2010-50



**3M™ Secure Click™ Organic
Vapor/Acid Gas Cartridge
D8003, 60 ea/Case**

3M Stock
7100153220
UPC
00051131374676
Alternative ID
D8003



**3M™ DBI-SALA® Lad-Saf™
Cable Vertical Safety System
Bracketry 6116631, 2 User,
Galvanized Steel**

3M Stock
7100237572
UPC
00840779173990
Alternative ID
6116631



**3M™ DBI-SALA® Lad-Saf™
Cable Vertical Safety System
Bracketry 6116632, 2 User,
Stainless Steel**

3M Stock
7100237753
UPC
00840779174003
Alternative ID
6116632



**3M™ DBI-SALA® Lad-Saf™
Cable Vertical Safety System
Bracketry 6116633, 4 User,
Galvanized Steel**

3M Stock
7100237754

UPC
00840779174010

Alternative ID
6116633



**3M™ DBI-SALA® Reusable
Swiveling Roof Anchor For
Wood/Metal 2190071, with
Fastener Kit**

3M Stock
7012779168

Previous 3M Stock
2190071

UPC
00840779162109

Alternative ID
2190071



**3M™ DBI-SALA® Lad-Saf™
Cable Vertical Safety System
Bracketry, Climb Extension
6116636, 2 User, Galvanized
Steel**

3M Stock
7100227918

UPC
00840779174041

Alternative ID
6116636



**3M™ DBI-SALA® Nano-Lok™
Connected Order Picker Self-
Retracting Lifeline Kit 3100268,
Electronic Box, Mounting Kit, 6 ft**

3M Stock
7012818443

Previous 3M Stock
3100268

Alternative ID
3100268



**3M™ DBI-SALA® Roofers Fall
Protection Compliance Kit
2104169, Anchor, Harness,
Rope Grab/Lanyard, Lifeline, 50
ft**

3M Stock
7012818307

Previous 3M Stock
2104169

UPC
00840779111701

Alternative ID
2104169



**3M™ DBI-SALA® Roofer's Fall
Protection Kit 2104168**

3M Stock
7100228429

Previous 3M Stock
2104168

UPC
00840779000678

Alternative ID
2104168



**3M™ DBI-SALA® Lad-Saf™
Ladder Anchor Post with
Removable Extension 6116026,
Galvanized Steel**

3M Stock
7100250926
Previous 3M Stock
6116026
UPC
00648250162033
Alternative ID
6116026



**3M™ Half Facepiece Reusable
Respirator 7502/37082(AAD)
Medium 10 EA/Case**

3M Stock
7000002162
Previous 3M Stock
70071042785
UPC
50051131370826
Alternative ID
7502



**3M™ DBI-SALA® Metal
Horizontal Lifeline Energy
Absorber 7401013, Stainless
Steel**

3M Stock
7100260186
Previous 3M Stock
7401013
UPC
00840779003884
Alternative ID
7401013



**3M™ DBI-SALA® EZ-Stop™
Spreader Hook Positioning
Device 2108403, Zinc Plated
Steel, 10 in**

3M Stock
7012818352
Previous 3M Stock
2108403
UPC
00648250162514
Alternative ID
2108403



**3M™ DBI-SALA® Permanent
Multi-Span Horizontal Lifeline
Intermediate Bracket 7608001**

3M Stock
7100301367
Previous 3M Stock
7608001
UPC
00840779005499
Alternative ID
7608001



**3M™ Protecta® Reusable Roof
Anchor For Standing Seam
2190072, Fits 12 in, 24 in, 30 in,
32 in, 36 in Spacing**

3M Stock
7100237100
Previous 3M Stock
2190072
UPC
00840779162116
Alternative ID
2190072



**3M™ DBI-SALA® Rollgliss™
Technical Rescue Offset D Fall
Arrest Carabiner with Captive
Eye, 2000117, Gold, Medium**

3M Stock
7100221696

UPC
00840779008339

Alternative ID
2000117



**3M™ DBI-SALA® Roof Top
Anchor 2100138**

3M Stock
7100228424

Previous 3M Stock
2100138

UPC
00840779103478

Alternative ID
2100138



**3M™ DBI-SALA® Portable
Tandem Pulley Anchor 8800023,
Fits 3/8 - 1/2 in Rope/Cable**

3M Stock
7100260112

Previous 3M Stock
8800023

UPC
00840779005826

Alternative ID
8800023



**3M™ DBI-SALA® Portable
Counterweight Pylon Anchor
7256000, with 45 lb Weights**

3M Stock
7100314306

Alternative ID
7256000



**3M™ DBI-SALA® SSB Cable
Climb Assist System Fall Arrest
Block Pulley Assembly 3511063,
Galvanized Steel**

3M Stock
7100268944

UPC
00840779003785

Alternative ID
3511063



**3M™ Hard Hat Suspension
H-700S6, 6-Point Strap, 20
EA/Case**

3M Stock
7000053150

Previous 3M Stock
70071614229

UPC
10078371654921

Alternative ID
H-700-S6



3M™ DBI-SALA® Temporary I-Beam Horizontal Lifeline Stanchion with Base 7400056, Fits 18 - 24 in Flange Up To 2.25 in Thick

3M Stock
7012820230
Previous 3M Stock
7400056
UPC
00840779008650
Alternative ID
7400056



3M™ DBI-SALA® SecuraSpan™ Perpendicular I-Beam HLL Stanchion with Base 7400087, Order Separately, 1 ea

3M Stock
7100220277
Previous 3M Stock
7400087
UPC
00648250173923
Alternative ID
7400087



3M™ DBI-SALA® Temporary I-Beam Horizontal Lifeline Stanchion with Base 7400055, Fits 12 - 18 in Flange Up To 2.25 in Thick

3M Stock
7012820229
Previous 3M Stock
7400055
UPC
00840779008643
Alternative ID
7400055



3M™ DBI-SALA® Temporary I-Beam Horizontal Lifeline Stanchion with Base 7400057, Fits 24 - 36 in Flange Up To 2.25 in Thick

3M Stock
7012820231
Previous 3M Stock
7400057
UPC
00840779008667
Alternative ID
7400057



3M™ DBI-SALA® Lad-Saf™ Aluminum Ladder Gate with Fastener Kit 5901980

3M Stock
7012819640
Previous 3M Stock
5901980
UPC
00648250162637
Alternative ID
5901980



3M™ DBI-SALA® Nano-Lok™ Hot Work Self-Retracting Lifeline with Quick Connect 3100560, Web, Aluminum Rebar Hook, 6 ft

3M Stock
7100325444
Previous 3M Stock
70804106204
UPC
00648250242612
Alternative ID
3100560



**3M™ DBI-SALA® Nano-Lok™
Hot Work Self-Retracting Lifeline
with Quick Connect 3100558,
Web, Steel Rebar Lock Hook, 6
ft**

3M Stock
7100325443
Previous 3M Stock
70804106188
UPC
00648250242599
Alternative ID
3100558



**3M™ DBI-SALA® Nano-Lok™
Hot Work Personal Self-
Retracting Lifeline 3100556,
Kevlar® Fiber Web, 6 ft**

3M Stock
7012818538
Previous 3M Stock
3100556
UPC
00648250242575
Alternative ID
3100556



**3M™ DBI-SALA® Nano-Lok™
Hot Work Personal Self-
Retracting Lifeline 3100555,
Kevlar® Fiber Web, 6 ft**

3M Stock
7012818537
Previous 3M Stock
3100555
UPC
00648250242568
Alternative ID
3100555



**3M™ DBI-SALA® Nano-Lok™
Hot Work Personal Self-
Retracting Lifeline 3100557,
Kevlar® Fiber Web, 6 ft**

3M Stock
7012818539
Previous 3M Stock
3100557
UPC
00648250242582
Alternative ID
3100557



**3M™ DBI-SALA® Nano-Lok™
Twin-Leg Hot Work Self-
Retracting Lifeline with Quick
Connect 3100572, Web, Comfort
Grip Hook, 6ft**

3M Stock
7012818550
Previous 3M Stock
3100572
UPC
00648250242735
Alternative ID
3100572



**3M™ DBI-SALA® Nano-Lok™
Hot Work Twin-Leg Personal
Self-Retracting Lifeline 3100569,
Kevlar® Fiber Web, 6 ft**

3M Stock
7012818547
Previous 3M Stock
3100569
UPC
00648250242704
Alternative ID
3100569



3M™ DBI-SALA® Nano-Lok™
Hot Work Twin-Leg Personal
Self-Retracting Lifeline 3100568,
Kevlar® Fiber Web, 6 ft

3M Stock
7012818546

UPC
00648250242698

Alternative ID
3100568



3M™ DBI-SALA® Nano-Lok™
Hot Work Twin-Leg Personal
Self-Retracting Lifeline 3100565,
Kevlar® Fiber Web, 6 ft

3M Stock
7012818543

Previous 3M Stock
3100565

UPC
00648250242667

Alternative ID
3100565



3M™ DBI-SALA® Nano-Lok™
Hot Work Twin-Leg Personal
Self-Retracting Lifeline 3100566,
Kevlar® Fiber Web, 6 ft

3M Stock
7012818544

Previous 3M Stock
3100566

UPC
00648250242674

Alternative ID
3100566



3M™ DBI-SALA® Nano-Lok™
Hot Work Self-Retracting Lifeline
with Anchor Hook 3100562,
Kevlar® Fiber Web, 6 ft

3M Stock
7012828668

Previous 3M Stock
3100562

UPC
00648250242636

Alternative ID
3100562



3M™ DBI-SALA® Nano-Lok™
Hot Work Personal Self-
Retracting Lifeline 3100564,
Kevlar® Fiber Web, 6 ft

3M Stock
7012818542

Previous 3M Stock
3100564

UPC
00648250242650

Alternative ID
3100564



3M™ CSID Connected Safety ID
Mechanical Mount HF RFID Tag
9505839, Yellow, 25 ea/Pack

3M Stock
7100314320

Previous 3M Stock
9505839

UPC
00648250173688

Alternative ID
9505839



3M™ CSID Connected Safety ID Choker Mount HF RFID Tag 9505841, Black, 25 ea/Pack

3M Stock
7100314321
Previous 3M Stock
9505841
UPC
00840779108060
Alternative ID
9505841



3M™ DBI-SALA® Small Series Load Arrestor with Pulley 3700801, Galvanized Cable, 1760 lb Capacity, 13 ft

3M Stock
7012819498
Previous 3M Stock
3700801
UPC
00840779002542
Alternative ID
3700801



3M™ DBI-SALA® Small Series Load Arrestor 3700501, Galvanized Cable, 1100 lb Capacity, 17 ft

3M Stock
7012819497
Previous 3M Stock
3700501
UPC
00840779002535
Alternative ID
3700501



3M™ DBI-SALA® Small Series Load Arrestor 3700400, Galvanized Cable, 880 lb Capacity, 26 ft

3M Stock
7012819496
Previous 3M Stock
3700400
UPC
00840779002528
Alternative ID
3700400



3M™ DBI-SALA® Flexiguard™ M100 & M200 Modular Jib Smooth Surface Leveling Caster Assembly 8530908

3M Stock
7100280605
Previous 3M Stock
8530908
UPC
00648250177396
Alternative ID
8530908



3M™ Connected Safety ID Mechanical Mount HF RFID Tag CSID-POUCH, 9505841, Black, 25/Pack, 1 ea/Case

3M Stock
7010315367
Previous 3M Stock
70071696267
UPC
00051131274228
Alternative ID
RFID-POUCH



**3M™ DBI-SALA® Flexiguard™
Truck Hitch Joint Adaptor
8511401, Zinc Plated Steel**

3M Stock
7012820550
Previous 3M Stock
8511401
UPC
00840779006069
Alternative ID
8511401



**3M™ DBI-SALA® Confined
Space Permanent Deck Mount
Sleeve Davit Mast Base
8515834, Stainless Steel**

3M Stock
7100274752
Previous 3M Stock
8515834
UPC
00648250163191
Alternative ID
8515834



**3M™ DBI-SALA® Confined
Space Permanent Deck Mount
Sleeve Davit Mast Base
8515162, Zinc Plated Steel**

3M Stock
7100280644
Previous 3M Stock
8515162
UPC
00648250163160
Alternative ID
8515162



**3M™ PELTOR™ Tactical
Earplug TEP-300 TN, Tan**

3M Stock
7100227637
Previous 3M Stock
70071734282
UPC
00638060429877
Alternative ID
TEP-300 TN



**3M™ DBI-SALA® ExoFit™
Tongue Buckle Belt 1000708,
Gray, Small**

3M Stock
7012815010
Previous 3M Stock
1000708
UPC
00648250165584
Alternative ID
1000708



**3M™ DBI-SALA® Tongue
Buckle Restraint Belt with Hip
Pad 1000003, Yellow, Medium**

3M Stock
7012814925
Previous 3M Stock
1000003
UPC
00840779004355
Alternative ID
1000003



3M™ DBI-SALA® Tongue Buckle Belt 1000055, Yellow, X-Large

3M Stock
7012814953
Previous 3M Stock
1000055
UPC
00648250165355
Alternative ID
1000055



3M™ DBI-SALA® ExoFit NEX™ Tongue Buckle Belt 1000780, Gray, Medium

3M Stock
7012815023
Previous 3M Stock
1000780
UPC
00840779015368
Alternative ID
1000780



3M™ DBI-SALA® Derrick Tongue Buckle Positioning Belt with Pass-Thru Harness Connector 1000547, Yellow, 3X

3M Stock
7012814987
Previous 3M Stock
1000547
Alternative ID
1000547



3M™ DBI-SALA® Tongue Buckle Positioning Belt with Hip Pad 1000026, Yellow, 2X

3M Stock
7012814946
Previous 3M Stock
1000026
UPC
00840779014187
Alternative ID
1000026



3M™ DBI-SALA® Tongue Buckle Restraint Belt with Hip Pad 1000001, Yellow, X-Small

3M Stock
7012814922
Previous 3M Stock
1000001
UPC
00840779007448
Alternative ID
1000001



3M™ DBI-SALA® ExoFit™ Tongue Buckle Belt 1000709, Gray, Medium

3M Stock
7012815011
Previous 3M Stock
1000709
UPC
00840779007721
Alternative ID
1000709



3M™ DBI-SALA® Tongue Buckle Restraint Belt with Hip Pad 1000005, Yellow, X-Large

3M Stock
7100246614
Previous 3M Stock
1000005
UPC
00840779007455
Alternative ID
1000005



3M™ DBI-SALA® Derrick Tongue Buckle Positioning Belt with Pass-Thru Harness Connector 1000546, Yellow, 2X

3M Stock
7012814986
Previous 3M Stock
1000546
UPC
00840779014873
Alternative ID
1000546



3M™ DBI-SALA® Derrick Tongue Buckle Positioning Belt with Tongue Buckle Harness Connector 1003221, Yellow, Large

3M Stock
7012815131
UPC
00648250165706
Alternative ID
1003221



3M™ DBI-SALA® Tongue Buckle Restraint Belt with Hip Pad 1000002, Yellow, Small

3M Stock
7012814923
Previous 3M Stock
1000002
UPC
00840779004348
Alternative ID
1000002



3M™ DBI-SALA® Tongue Buckle Positioning Belt with Hip Pad 1000024, Yellow, Large

3M Stock
7012814942
Previous 3M Stock
1000024
UPC
00840779004386
Alternative ID
1000024



3M™ DBI-SALA® Derrick Tongue Buckle Positioning Belt with Pass-Thru Harness Connector 1000542, Yellow, Small

3M Stock
7012814982
Previous 3M Stock
1000542
UPC
00648250165454
Alternative ID
1000542



**3M™ DBI-SALA® Derrick
Tongue Buckle Positioning Belt
with Tongue Buckle Harness
Connector 1003224, Yellow, 3X**

3M Stock
7012815134
Previous 3M Stock
1003224
UPC
00840779016679
Alternative ID
1003224



**3M™ DBI-SALA® Tongue
Buckle Restraint Belt 1000164,
Yellow, Large**

3M Stock
7012814967
Previous 3M Stock
1000164
UPC
00648250165423
Alternative ID
1000164



**3M™ DBI-SALA® 3-Man
Swiveling Roof Anchor 2103690**

3M Stock
7100228428
Previous 3M Stock
2103690
UPC
00648250161463
Alternative ID
2103690



**3M™ DBI-SALA® Tongue
Buckle Belt 1000056, Yellow, 2X**

3M Stock
7012814954
Previous 3M Stock
1000056
UPC
00840779014279
Alternative ID
1000056



**3M™ DBI-SALA® ExoFit NEX™
Tongue Buckle Belt 1000782,
Gray, X-Large**

3M Stock
7012815025
Previous 3M Stock
1000782
UPC
00840779015382
Alternative ID
1000782



**3M™ DBI-SALA® ExoFit NEX™
Tongue Buckle Belt 1000783,
Gray, 2X**

3M Stock
7012815026
Previous 3M Stock
1000783
UPC
00840779015399
Alternative ID
1000783



3M™ DBI-SALA® Derrick Positioning Belt with Pass-Thru Suspension Strap Harness Connector 1000570, Yellow, Universal

3M Stock
7100268010

UPC
00840779004416

Alternative ID
1000570



3M™ DBI-SALA® Tongue Buckle Restraint Belt with Hip Pad 1000004, Yellow, Large

3M Stock
7012814927

Previous 3M Stock
1000004

UPC
00840779004362

Alternative ID
1000004



3M™ DBI-SALA® Derrick Tongue Buckle Positioning Belt with Tongue Buckle Harness Connector 1003220, Yellow, Medium

3M Stock
7012815130

UPC
00648250165690

Alternative ID
1003220



3M™ DBI-SALA® Reusable Heavy-Duty Roof Anchor 2103673

3M Stock
7100228426

Previous 3M Stock
2103673

UPC
00840779000661

Alternative ID
2103673



3M™ PELTOR™ CH-3 Headset MT74H52A-110, Headband, FLX2, 1 ea/Case

3M Stock
7100203637

UPC
04054596695573

Alternative ID
MT74H52A-110



3M™ Speedglas™ G5-01 Magnifying Lens Holder, 46-0680-00, 1 EA/Case

3M Stock
7100215539

Previous 3M Stock
70071735909

UPC
00076308944841

Alternative ID
46-0680-00



3M™ Speedglas™ G5-01 Task Light, No Power Cables Included, 46-0500-05, 1 EA/Bag

3M Stock
7100217182
Previous 3M Stock
70071697265
UPC
00076308944964
Alternative ID
46-0500-05



3M™ Speedglas™ G5-01 Short Helmet Power Cable for Task Light, 46-0500-03, 1 EA/Bag

3M Stock
7100216994
Previous 3M Stock
70071735818
UPC
00076308944766
Alternative ID
46-0500-03



3M™ Speedglas™ G5-01 Long Battery Power Cable for Task Light, 46-0500-02, 1 EA/Bag

3M Stock
7100216920
Previous 3M Stock
70071735800
UPC
00076308944759
Alternative ID
46-0500-02



3M™ Professional Series Half Facepiece Paint Spray Packout 37079, Large 4 EA/Case

3M Stock
7010341232
UPC
00051131370791
Alternative ID
37079



3M™ Cap Suspension H-213-2/37117(AAD) 2 EA/Case

3M Stock
7000126541
Previous 3M Stock
70071093622
UPC
50051131371175
Alternative ID
H-213-2



3M™ Versaflo™ Replacement Head Suspension M-350, for use with M-300 and M-400 Hardhats 1 EA/Case

3M Stock
7000127679
Previous 3M Stock
70071562022
Alternative ID
M-350



3M™ PELTOR™ X1 Earmuffs X1A/37270(AAD), Over-the-Head, 10 EA/Case

3M Stock
7000104070
Previous 3M Stock
XA007707830
UPC
10093045937230
Alternative ID
X1A



3M™ PELTOR™ Hard Hat Attached Electrically Insulated Earmuffs X1P5E, 10 EA/Case

3M Stock
7100097525
Previous 3M Stock
UU007831710
UPC
10078371671003
Alternative ID
X1P5E



3M™ PELTOR™ X1 Earmuffs X1P3E/37275(AAD), Hard Hat Attached, 10 ea/Case

3M Stock
7000104075
Previous 3M Stock
XA007707889
UPC
10093045937285
Alternative ID
X1P3E



3M™ DBI-SALA® Single-Span Horizontal Lifeline For Stanchions 7403050, Galvanized Cable, 50 ft

3M Stock
7012820261
Previous 3M Stock
7403050
UPC
00840779005055
Alternative ID
7403050



3M™ DBI-SALA® Single-Span Horizontal Lifeline For Stanchions 7403030, Galvanized Cable, 30 ft

3M Stock
7012820259
Previous 3M Stock
7403030
UPC
00840779005031
Alternative ID
7403030



3M™ DBI-SALA® Sealed-Blok™ Self-Retracting Lifeline 3400169, Stainless Steel Cable, 85 ft

3M Stock
7012828686
UPC
00648250253373
Alternative ID
3400169



3M™ DBI-SALA® Sealed-Blok™
3-Way Retrieval Self-Retracting
Lifeline 3400170, Stainless Steel
Cable, 130 ft

3M Stock
7100323508
UPC
00648250253380
Alternative ID
3400170



3M™ DBI-SALA® Sealed-Blok™
Self-Retracting Lifeline 3400172,
Stainless Steel Cable, 130 ft

3M Stock
7012828687
UPC
00648250253403
Alternative ID
3400172



3M™ DBI-SALA® Sealed-Blok™
3-Way Retrieval Self-Retracting
Lifeline with Bracket 3400171,
Stainless Steel Cable, 130 ft.

OSHA
3M Stock
7100324056
UPC
00648250253397
Alternative ID
3400171



3M™ DBI-SALA® Sealed-Blok™
3-Way Retrieval Self-Retracting
Lifeline with Bracket 3400151,
Rope, 55 ft

3M Stock
7012828681
Previous 3M Stock
3400151
Alternative ID
3400151



3M™ DBI-SALA® Sealed-Blok™
Self-Retracting Lifeline 3400145,
Retrieval with Bracket, Stainless
Steel Cable, 30 ft. (9 m)

3M Stock
7100307003
UPC
00648250244142
Alternative ID
3400145



3M™ DBI-SALA® Sealed-Blok™
Self-Retracting Lifeline 3400144,
Retrieval, Stainless Steel Cable,
30 ft. (9 m)

3M Stock
7100307002
UPC
00648250244135
Alternative ID
3400144



**3M™ DBI-SALA® Sealed-Blok™
Self-Retracting Lifeline 3400133,
Stainless Steel Cable, 30 ft. (9
m)**

3M Stock
7100306999
UPC
00648250244029
Alternative ID
3400133



**3M™ DBI-SALA® Sealed-Blok™
3-Way Retrieval Self-Retracting
Lifeline with Bracket 3400923,
Galvanized Cable, 50 ft**

3M Stock
7100281221
Previous 3M Stock
3400923
UPC
00840779072613
Alternative ID
3400923



**3M™ DBI-SALA® Sealed-Blok™
Self-Retracting Lifeline 3400173,
Stainless Steel Cable, 175 ft**

3M Stock
7012828688
UPC
00648250253410
Alternative ID
3400173



**3M™ DBI-SALA® Sealed-Blok™
3-Way Retrieval Self-Retracting
Lifeline 3400149, Stainless Steel
Cable, Snap Hook, 50 ft, Cla...**

3M Stock
7100318432
UPC
00648250244180
Alternative ID
3400149



**3M™ DBI-SALA® Sealed-Blok™
Self Retracting Lifeline 3400135,
Stainless Steel Cable, Swivel
Snap Hook, 50 ft., Class 1, ANSI**

3M Stock
7100318431
UPC
00648250244043
Alternative ID
3400135



**3M™ DBI-SALA®
Rescue/Retrieval Y-Lanyard with
Spreader Bar 1231460, 1 EA**

3M Stock
7100188784
UPC
00840779010776
Alternative ID
1231460



**3M™ DBI-SALA®
Rescue/Retrieval Web
Y-Lanyard with Spreader Bar
1231462, 4 ft**

3M Stock
7012691244
Previous 3M Stock
1231462
UPC
00840779041282
Alternative ID
1231462



**3M™ DBI-SALA® Trigger X Tie-
Back Adjustable Single/Double
Mode Rope Positioning Lanyard
1234089, 1/2 in Aramid
Kernmantle...**

3M Stock
7012817099
Previous 3M Stock
1234089
UPC
00840779162284
Alternative ID
1234089



**3M™ DBI-SALA® Trigger X Tie-
Back Adjustable Single/Double
Mode Rope Positioning Lanyard
1234091, 1/2 in Aramid
Kernmantle...**

3M Stock
7012817101
Previous 3M Stock
1234091
UPC
00840779162307
Alternative ID
1234091



**3M™ DBI-SALA® Trigger X Tie-
Back Adjustable Single Mode
Rope Positioning Lanyard
1234092, 1/2 in Aramid
Kernmantle, 6 ft**

3M Stock
7012817102
Previous 3M Stock
1234092
UPC
00840779162314
Alternative ID
1234092



**3M™ DBI-SALA® Trigger X
Adjustable Single Mode Rope
Positioning Lanyard 1234090,
1/2 in Aramid Kernmantle, 6 ft**

3M Stock
7012817100
Previous 3M Stock
1234090
UPC
00840779162291
Alternative ID
1234090



**Remote Training
& Implementation**

**3M™ Health, Safety and
Compliance Software Training, 1
Hour**

3M Stock
6100001903
Previous 3M Stock
70999986576
Alternative ID
SIM-TRN-WEB



**3M™ DBI-SALA® Detent Anchor
Pour-in-Place Socket For
Concrete 2100152**

3M Stock
7100246180
Previous 3M Stock
2100152
UPC
00648250160169
Alternative ID
2100152



**3M™ Protecta® Reusable
Swiveling Roof Anchor For
Wood/Metal 2190070, with
Fastener Kit**

3M Stock
7100237099
Previous 3M Stock
2190070
UPC
00840779162093
Alternative ID
2190070



**3M™ DBI-SALA® U Maxi Clamp
4-Pack 7241208, 4 ea/Pack**

3M Stock
7100314937
UPC
03660570064573
Alternative ID
7241208



**3M™ Speedglas™ 9100
FX/9100 FX-Air Welding Helmet
SideWindow Covers
06-0700-73, Black, 2 EA/Case**

3M Stock
7000128086
Previous 3M Stock
70071606373
UPC
00051131496811
Alternative ID
06-0700-73



**3M™ Speedglas™ Welding
Helmet Bag SG-96, G5-02**

3M Stock
7100239736
Previous 3M Stock
70071736147
UPC
00076308944476
Alternative ID
SG-96



**3M™ Speedglas™ Carry Bag
SG-90, Black, 1 EA/Case**

3M Stock
7000128116
Previous 3M Stock
70071607983
UPC
00051131498716
Alternative ID
SG-90



**3M™ Speedglas™ G5 Series
Carry & Storage Bag, SG-95, 1
EA/Case**

3M Stock
7100215530
Previous 3M Stock
70071735834
UPC
00076308944780
Alternative ID
SG-95



**3M™ DBI-SALA® Sliding Rail
Anchor 2199938, Stainless
Steel, Fits 2-3/4 – 3-1/4 in Rails**

3M Stock
7100246255
Previous 3M Stock
2199938
UPC
00840779113552
Alternative ID
2199938



**3M™ Rugged Comfort Quick
Latch Half Facepiece Reusable
Respirator 6501QL/49488,
Small, 10 EA/Case**

3M Stock
7000128237
Previous 3M Stock
70071621828
UPC
50051131494881
Alternative ID
6501QL



**3M™ Rugged Comfort Quick
Latch Half Facepiece Reusable
Respirator 6502QL/49490,
Medium, 10 EA/Case**

3M Stock
7000128239
Previous 3M Stock
70071621844
UPC
50051131494904
Alternative ID
6502QL



**3M™ Half Facepiece Disposable
Respirator Assembly 52P71,
Organic Vapor/P95 Respiratory
Protection, Medium 12 EA/Case**

3M Stock
7000052080
Previous 3M Stock
70070797181
UPC
50051138660692
Alternative ID
52P71



**3M™ Infant Eartip 3.5mm
420-2094, 10 Pair EA/Case**

3M Stock
7100133269
Previous 3M Stock
70071647013
UPC
10080529510102
Alternative ID
420-2094



3M™ PELTOR™ Optime™ 101 Earmuffs H7P3E, Hard Hat Attached, 10 EA/Case

3M Stock
7000009668

Previous 3M Stock
XH001651245

UPC
10093045080738

Alternative ID
H7P3E



3M™ PELTOR™ Optime™ 101 Earmuffs H7A, Over-the-Head, 10 EA/Case

3M Stock
7000009669

Previous 3M Stock
XH001651260

UPC
10093045080714

Alternative ID
H7A



3M™ Versaflo™ Replacement Visor Frame Assembly M-920/37320(AAD), 1 EA/Case

3M Stock
7000127687

Previous 3M Stock
70071562147

UPC
00051131373204

Alternative ID
M-920



3M™ DBI-SALA® Detent Anchor D-ring/Pin For Concrete 2101002

3M Stock
7012818270

Previous 3M Stock
2101002

UPC
00840779011759

Alternative ID
2101002



3M™ DBI-SALA® Flexiguard™ A-Frame Rail Adjustable Height Anchor System 8517780, 2 User, Yellow, 16 - 22.5 ft Height, 20 f...

3M Stock
7100231968

UPC
00840779099825

Alternative ID
8517780



3M™ DBI-SALA® Temporary Pour/Fasten-In-Place Horizontal Lifeline Intermediate Bracket 7400200

3M Stock
7012820239

Previous 3M Stock
7400200

UPC
00840779004768

Alternative ID
7400200



3M™ DBI-SALA® Concrete Detent Anchor 2101004, 1 EA

3M Stock
7100188833
Previous 3M Stock
2101004
UPC
00840779011766
Alternative ID
2101004



3M™ DBI-SALA® Lad-Saf™ Cable Vertical Safety System Cable Guide Support 6100136, Stainless Steel

3M Stock
7012819665
Previous 3M Stock
6100136
UPC
00648250161999
Alternative ID
6100136



3M™ PELTOR™ Replacement Battery PIC-100BA, 20 ea/Case

3M Stock
7100262644
Previous 3M Stock
70071766292
UPC
00638060433102
Alternative ID
PIC-100BA



3M™ DBI-SALA® FlexiGuard™ M200 Adjustable Upright Fork Pocket Kit 8530912

3M Stock
7100314340
Previous 3M Stock
8530912
UPC
00648250185094
Alternative ID
8530912



3M™ Belt Loop with D-ring 1500115, 5 lb Capacity

3M Stock
7012818151
Previous 3M Stock
1500115
UPC
00852684930117
Alternative ID
1500115



3M™ DBI-SALA® Harness Adaptor 1500161, 1 EA/PACK

3M Stock
7100214238
Previous 3M Stock
1500161
UPC
00840779151257
Alternative ID
1500161



3M™ Adjustable Hook and Loop Wristband with Cord 1500084, 5 lb Capacity, Universal

3M Stock
7012818122
Previous 3M Stock
1500084
UPC
00852684933088
Alternative ID
1500084



3M™ Belt Loop with Trigger 1500118, 5 lb Capacity, 10 ea/Pack

3M Stock
7100249204
Previous 3M Stock
1500118
UPC
00852684930186
Alternative ID
1500118



3M™ DBI-SALA® Adjustable Wristband with Cord 1500085, 10/Pack

3M Stock
7100230443
Previous 3M Stock
1500085
UPC
00852684933101
Alternative ID
1500085



3M™ Belt Loop with D-ring 1500116, 5 lb Capacity, 10 ea/Pack

3M Stock
7100310178
Previous 3M Stock
1500116
UPC
00852684930131
Alternative ID
1500116



3M™ DBI-SALA® EZ-Stop™ Modular Shock Absorber Assembly For Leading Edge Self-Retracting Lifeline 1246500

3M Stock
7100260189
Previous 3M Stock
1246500
UPC
00840779192472
Alternative ID
1246500



3M™ DBI-SALA® EZ-Stop™ Leading Edge Self-Retracting Lifeline with Modular Rubber Shock Cover 1246512

3M Stock
7012817306
Previous 3M Stock
1246512
Alternative ID
1246512



**3M™ Lens Cover
7899-100/7899-100-AM,
Accessory 100 EA/Case**

3M Stock
7100189715
Previous 3M Stock
70071731411
UPC
50051131278184
Alternative ID
7899-100/7899-100-
AM



**3M™ Semi-Permanent Lens
Protector FF-400-17, 20
EA/Case**

3M Stock
7000029959
Previous 3M Stock
70071516986
UPC
50051135894878
Alternative ID
FF-400-17



**3M™ Lens Cover FF-400-15,
100 ea/Bag**

3M Stock
7000029958
Previous 3M Stock
70071516978
UPC
50051135894861
Alternative ID
FF-400-15



**3M™ Tinted Lens Cover 6886,
Accessory 25 EA/Bag**

3M Stock
7000052088
Previous 3M Stock
70070799419
UPC
50051138661873
Alternative ID
6886



**3M™ Faceshield Cover
6885/07142(AAD), 100 ea/Bag**

3M Stock
7100138628
Previous 3M Stock
70070709103
UPC
50051131071426



**3M™ DBI-SALA® Nano-Lok™
edge Personal Self-Retracting
Lifeline 3500293, Galvanized
Cable, 8 ft**

3M Stock
7012828694
UPC
00648250243619
Alternative ID
3500293



**3M™ DBI-SALA® Nano-Lok™
edge Personal Self-Retracting
Lifeline 3500292, Galvanized
Cable, 7.3 ft**

3M Stock
7012828693
Previous 3M Stock
3500292
UPC
00648250243602
Alternative ID
3500292



**3M™ DBI-SALA® Nano-Lok™
edge Personal Self-Retracting
Lifeline 3500291, Galvanized
Cable, 8 ft**

3M Stock
7012828692
UPC
00648250243596
Alternative ID
3500291



**3M™ DBI-SALA® Nano-Lok™
edge Tie-Back Personal Self-
Retracting Lifeline 3500297,
Galvanized Cable, 9 ft**

3M Stock
7012828697
Previous 3M Stock
3500297
UPC
00648250243657
Alternative ID
3500297



**3M™ DBI-SALA® Nano-Lok™
edge Personal Self-Retracting
Lifeline 3500296, Galvanized
Cable, 7 ft**

3M Stock
7012819235
Previous 3M Stock
3500296
UPC
00648250243640
Alternative ID
3500296



**3M™ DBI-SALA® Nano-Lok™
edge Personal Self-Retracting
Lifeline 3500295, Galvanized
Cable, 8 ft**

3M Stock
7012828696
Previous 3M Stock
3500295
UPC
00648250243633
Alternative ID
3500295



**3M™ DBI-SALA® Nano-Lok™
edge Personal Self-Retracting
Lifeline 3500294, Galvanized
Cable, 8 ft**

3M Stock
7012828695
Previous 3M Stock
3500294
UPC
00648250243626
Alternative ID
3500294



**3M™ DBI-SALA® Nano-Lok™
edge Twin-Leg Tie-Back
Personal Self-Retracting Lifeline
3500228, Galvanized Cable, 9 ft**

3M Stock
7012819190
Previous 3M Stock
3500228
UPC
00648250168509
Alternative ID
3500228



**3M™ DBI-SALA® Nano-Lok™
edge Personal Self-Retracting
Lifeline 3500290, Galvanized
Cable, 8 ft**

3M Stock
7012819234
Previous 3M Stock
3500290
UPC
00648250243589
Alternative ID
3500290



**3M™ DBI-SALA® Nano-Lok™
edge Personal Self-Retracting
Lifeline 3500289, Galvanized
Cable, 8 ft**

3M Stock
7012819233
Previous 3M Stock
3500289
UPC
00648250243572
Alternative ID
3500289



**3M™ DBI-SALA® Nano-Lok™
edge Personal Self-Retracting
Lifeline 3500288, Galvanized
Cable, 8 ft**

3M Stock
7012828691
Previous 3M Stock
3500288
UPC
00648250243565
Alternative ID
3500288



**3M™ Versaflo™ Peel-Off Visor
Cover S-920S, Small - Medium,
for Integrated Suspension
Products 40 EA/Case**

3M Stock
7000127435
Previous 3M Stock
70071533361
UPC
50051131171003
Alternative ID
S-920S



**3M™ Versaflo™ Peel-Off Visor
Covers M-926/37322(AAD), for
M-925 Standard Visor, 40
EA/Case**

3M Stock
7000127689
Previous 3M Stock
70071562162
UPC
50051131373223
Alternative ID
M-926



3M™ DBI-SALA® Nano-Lok™
Edge Twin-Leg Tie-Back
Personal Self-Retracting Lifeline
3500287, Galvanized Cable, 9 ft

3M Stock
7012828690
Previous 3M Stock
3500287
UPC
00648250243558
Alternative ID
3500287



3M™ DBI-SALA® Nano-Lok™
Edge Twin-Leg Personal Self-
Retracting Lifeline 3500276,
Galvanized Cable, 8 ft

3M Stock
7012819222
UPC
00648250243442
Alternative ID
3500276



3M™ DBI-SALA® Nano-Lok™
Edge Twin-Leg Personal Self
Retracting Lifeline 3500277
Cable, Aluminum Rebar Lock
Hook 8 ft. Cla...

3M Stock
7012819223
UPC
00648250243459
Alternative ID
3500277



3M™ DBI-SALA® Nano-Lok™
Edge Twin-Leg Personal Self
Retracting Lifeline 3500278,
Cable, Steel Rebar Hook, 7.3 ft.,
Class ...

3M Stock
7012819224
Previous 3M Stock
3500278
UPC
00648250243466
Alternative ID
3500278

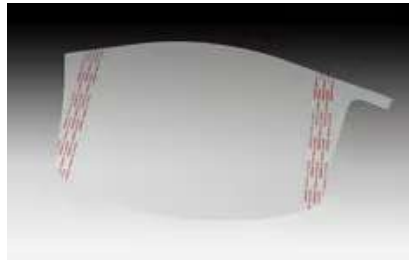

3M™ Versaflo™ Peel-Off Visor
Covers M-928/37452(AAD), for
M-927 Premium Visor, 40
ea/Bag

3M Stock
7100138631
Previous 3M Stock
70071563939
UPC
50051131374527



3M™ DBI-SALA® Nano-Lok™
Edge Twin-Leg Personal Self-
Retracting Lifeline 3500284,
Galvanized Cable, 7 ft

3M Stock
7012819230
Previous 3M Stock
3500284
UPC
00648250243527
Alternative ID
3500284



3M™ DBI-SALA® Nano-Lok™
Edge Twin-Leg Personal Self-
Retracting Lifeline 3500285,
Galvanized Cable, 8 ft

3M Stock
7012819231
Previous 3M Stock
3500285
UPC
00648250243534
Alternative ID
3500285



3M™ DBI-SALA® Nano-Lok™
Edge Twin-Leg Personal Self-
Retracting Lifeline 3500286,
Galvanized Cable, 8 ft

3M Stock
7012819232
Previous 3M Stock
3500286
UPC
00648250243541
Alternative ID
3500286



3M™ DBI-SALA® Nano-Lok™
Edge Twin-Leg Personal Self
Retracting Lifeline 3500280,
Cable, Aluminum Rebar Hook, 8
ft., Class...

3M Stock
7012819226
Previous 3M Stock
3500280
UPC
00648250243480
Alternative ID
3500280



3M™ DBI-SALA® Nano-Lok™
Edge Twin-Leg Personal Self-
Retracting Lifeline 3500281,
Cable, Steel Rebar Hook, 6 ft.,
Class 2,...

3M Stock
7012819227
Previous 3M Stock
3500281
UPC
00648250243497
Alternative ID
3500281



3M™ DBI-SALA® Nano-Lok™
Edge Twin-Leg Personal Self
Retracting Lifeline 3500282,
Cable, Steel Swivel Snap Hook,
8 ft. Cla...

3M Stock
7012819228
Previous 3M Stock
3500282
UPC
00648250243503
Alternative ID
3500282



3M™ DBI-SALA® Nano-Lok™
Edge Twin-Leg Personal Self
Retracting Lifeline 3500283,
Cable, Aluminum Comfort Hook,
7 ft., Cla...

3M Stock
7012819229
Previous 3M Stock
3500283
UPC
00648250243510
Alternative ID
3500283



**3M™ Protecta® Modular
Connector Shock Pack 1340151,
Steel Swivel Snap Hook**

3M Stock
7100318430
Previous 3M Stock
1340151
UPC
00648250246146
Alternative ID
1340151



**3M™ Speedglas™ G5-01 Inner
Grinding Visor 46-0700-51, Anti-
Fog and Hardcoated**

3M Stock
7100232450
UPC
00638060430644
Alternative ID
46-0700-51



**3M™ Versaflo™ M-930 Visor
Lock Kit 5 EA/Bag**

3M Stock
7100198700
Previous 3M Stock
70071732237
UPC
00051131279315
Alternative ID
M930



**3M™ Elevated Temperature
Universal Faceshield Holder For
Hard Hat H24T, Black, 10
EA/Case**

3M Stock
7100113761
Previous 3M Stock
70071694460
UPC
50051131275107
Alternative ID
H24T



**3M™ U5B-ANSI Faceshield
Holder for SecureFit™ Safety
Helmet 10 EA/Case**

3M Stock
7100179142
UPC
00076308943172
Alternative ID
U5B-ANSI



**3M™ Universal Headgear For
Hard Hat H24M 82520-10000,
20 ea/Case**

3M Stock
7000002292
Previous 3M Stock
70071513371
UPC
10078371825208
Alternative ID
82520-10000



3M™ DBI-SALA® Permanent Multi-Span Horizontal Lifeline Sleeve 7608002

3M Stock
7100301368
Previous 3M Stock
7608002
UPC
00648250162798
Alternative ID
7608002

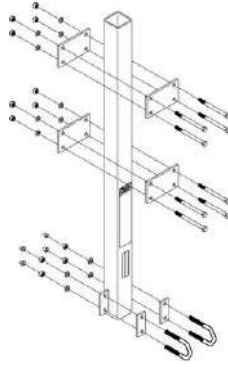

3M™ DBI-SALA® Lad-Saf™ Bottom Bracket For Ladder Mast/Ladder Anchor Post 6116027, Galvanized Steel

3M Stock
7100250927
Previous 3M Stock
6116027
UPC
00648250162040
Alternative ID
6116027



3M™ Secure Click™ Multi-Gas/Vapor Cartridge/Filter P100 D80926, 60 ea/Case

3M Stock
7100153234
UPC
00051141566818
Alternative ID
D80926



3M™ Secure Click™ Organic Vapor Cartridge/Filter P100 D80921, 60 ea/Case

3M Stock
7100153232
UPC
00051141566764
Alternative ID
D80921



3M™ Secure Click™ Organic Vapor/Acid Gas Cartridge/Filter P100 D80923, 60 ea/Case

3M Stock
7100153233
UPC
00051141566788
Alternative ID
D80923



3M™ DBI-SALA® Nano-Lok™ Twin-Leg Connector 3100087

3M Stock
7100157031
Previous 3M Stock
3100087
UPC
00840779012039
Alternative ID
3100087



3M™ Protecta® Tripod Mounting Base Bracket - For Retrieval SRL 8008005, Silver

3M Stock
7100232969
Previous 3M Stock
8008005
UPC
00648250169841
Alternative ID
8008005



3M™ Double Locking Rebar Snap Hook 2109193, Zinc Plated Steel, 3600 lb Gate, 2 1/2 in Throat

3M Stock
7100311021
Previous 3M Stock
2109193
Alternative ID
2109193



3M™ Speedglas™ 9100MP Welding Helmet 27-0099-35SW, with Hard Hat and SideWindows, No ADF, 1 EA/Case

3M Stock
7000128221
Previous 3M Stock
70071621562
UPC
00051141558103
Alternative ID
27-0099-35SW



3M™ Speedglas™ G5-01 Hinge Mechanism, 46-0400-56

3M Stock
7100232457
Previous 3M Stock
70071738333
UPC
00638060430668
Alternative ID
46-0400-56

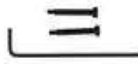

3M™ Versaflo™ Battery Attachment Tool TR-838/94244(AAD), for TR-800 PAPR and TR-830 Battery, 1 EA

3M Stock
7100150921
UPC
00076308942441
Alternative ID
TR-838



3M™ DBI-SALA® Confined Space Permanent Core Mount Sleeve Davit Mast Base 8510109, Zinc Plated Steel

3M Stock
7100311206
Previous 3M Stock
8510109
UPC
00840779003983
Alternative ID
8510109



3M™ DBI-SALA® Confined Space Permanent Core Mount Sleeve Davit Mast Base 8510110, Stainless Steel

3M Stock
7100314311
Previous 3M Stock
8510110
UPC
00840779005956
Alternative ID
8510110

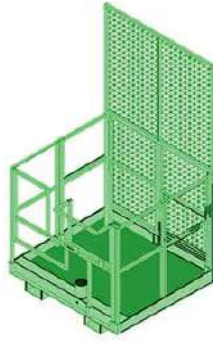

3M™ DBI-SALA® Confined Space Integrated Forklift Basket Davit Mast Base 8510568

3M Stock
7012820528
Previous 3M Stock
8510568
Alternative ID
8510568



3M™ DBI-SALA® Reusable Compact Roof Anchor 2103677

3M Stock
7100228427
Previous 3M Stock
2103677
UPC
00840779011797
Alternative ID
2103677



3M™ DBI-SALA® Lad-Saf™ Swaged Cable 6106200, 3/8 Inch, 7x19, Galvanized Steel, 200 FT

3M Stock
7100184460
UPC
00840779166015
Alternative ID
6106200



3M™ DBI-SALA® Lad-Saf™ Swaged Cable 6106180, 3/8 Inch, 7x19, Galvanized Steel, 180 FT

3M Stock
7100184458
UPC
00840779165995
Alternative ID
6106180



3M™ DBI-SALA® Lad-Saf™ Swaged Cable 6106240, 3/8 Inch, 7x19, Galvanized Steel, 240 FT

3M Stock
7100184462
Previous 3M Stock
6106240
UPC
00840779166039
Alternative ID
6106240



3M™ DBI-SALA® Lad-Saf™
Swaged Cable 6105010, 3/8
Inch, 1x7, Stainless Steel, 10 FT

3M Stock
7100184345
Previous 3M Stock
6105010
UPC
00840779152902
Alternative ID
6105010



3M™ DBI-SALA® Lad-Saf™
Swaged Cable 6106010, 3/8
Inch, 7x19, Galvanized Steel, 10
FT

3M Stock
7100184350
Previous 3M Stock
6106010
UPC
00840779152957
Alternative ID
6106010



3M™ DBI-SALA® Lad-Saf™
Swaged Cable 6107060, 3/8
Inch, 7x19, Stainless Steel, 60
FT

3M Stock
7100184471
Previous 3M Stock
6107060
UPC
00840779166121
Alternative ID
6107060



3M™ DBI-SALA® Lad-Saf™
Swaged Cable 6105050, 3/8
Inch, 1x7, Stainless Steel, 50 FT

3M Stock
7100184349
UPC
00840779152940
Alternative ID
6105050



3M™ DBI-SALA® Lad-Saf™
Swaged Cable 6105030, 3/8
Inch, 1x7, Stainless Steel, 30 FT

3M Stock
7100184347
UPC
00840779152926
Alternative ID
6105030



3M™ DBI-SALA® Lad-Saf™
Swaged Cable 6107030, 3/8
Inch, 7x19, Stainless Steel, 30
FT

3M Stock
7100184357
Previous 3M Stock
6107030
UPC
00840779153022
Alternative ID
6107030



3M™ DBI-SALA® Lad-Saf™
Swaged Cable 6106050, 3/8
Inch, 7x19, Galvanized Steel, 50
FT

3M Stock
7100184354
UPC
00840779152995
Alternative ID
6106050



3M™ DBI-SALA® Lad-Saf™
Swaged Cable 6104060, 3/8
Inch, 1x7, Galvanized Steel, 60
FT

3M Stock
7100184360
Previous 3M Stock
6104060
UPC
00840779163595
Alternative ID
6104060



3M™ DBI-SALA® Lad-Saf™
Swaged Cable 6107050, 3/8
Inch, 7x19, Stainless Steel, 50
FT

3M Stock
7100184359
Previous 3M Stock
6107050
UPC
00840779153046
Alternative ID
6107050



3M™ DBI-SALA® Lad-Saf™
Swaged Cable 6104090, 3/8
Inch, 1x7, Galvanized Steel, 90
FT

3M Stock
7100184363
Previous 3M Stock
6104090
UPC
00840779163625
Alternative ID
6104090



3M™ DBI-SALA® Lad-Saf™
Swaged Cable 6107150, 3/8
Inch, 7x19, Stainless Steel, 150
FT

3M Stock
7100184484
Previous 3M Stock
6107150
UPC
00840779166251
Alternative ID
6107150



3M™ DBI-SALA® Lad-Saf™
Swaged Cable 6104080, 3/8
Inch, 1x7, Galvanized Steel, 80
FT

3M Stock
7100184362
Previous 3M Stock
6104080
UPC
00840779163618
Alternative ID
6104080



3M™ DBI-SALA® Lad-Saf™
Swaged Cable 6104070, 3/8
Inch, 1x7, Galvanized Steel, 70
FT

3M Stock
7100184361
Previous 3M Stock
6104070
UPC
00840779163601
Alternative ID
6104070



3M™ DBI-SALA® Lad-Saf™
Swaged Cable 6105080, 3/8
Inch, 1x7, Stainless Steel, 80 FT

3M Stock
7100184367
Previous 3M Stock
6105080
UPC
00840779163663
Alternative ID
6105080



3M™ DBI-SALA® Lad-Saf™
Swaged Cable 6106045, 3/8
Inch, 7x19, Galvanized Steel, 45
FT

3M Stock
7100184440
Previous 3M Stock
6106045
UPC
00840779165810
Alternative ID
6106045



3M™ DBI-SALA® Lad-Saf™
Swaged Cable 6105045, 3/8
Inch, 1x7, Stainless Steel, 45 FT

3M Stock
7100184416
Previous 3M Stock
6105045
UPC
00840779165575
Alternative ID
6105045



3M™ DBI-SALA® Lad-Saf™
Swaged Cable 6105035, 3/8
Inch, 1x7, Stainless Steel, 35 FT

3M Stock
7100184415
Previous 3M Stock
6105035
UPC
00840779165568
Alternative ID
6105035



3M™ DBI-SALA® Lad-Saf™
Swaged Cable 6105085, 3/8
Inch, 1x7, Stainless Steel, 85 FT

3M Stock
7100184420
Previous 3M Stock
6105085
UPC
00840779165612
Alternative ID
6105085



3M™ DBI-SALA® Lad-Saf™
Swaged Cable 6105075, 3/8
Inch, 1x7, Stainless Steel, 75 FT

3M Stock
7100184419
Previous 3M Stock
6105075
UPC
00840779165605
Alternative ID
6105075



3M™ DBI-SALA® Lad-Saf™
Swaged Cable 6105055, 3/8
Inch, 1x7, Stainless Steel, 55 FT

3M Stock
7100184417
Previous 3M Stock
6105055
UPC
00840779165582
Alternative ID
6105055



3M™ DBI-SALA® Lad-Saf™
Swaged Cable 6105160, 3/8
Inch, 1x7, Stainless Steel, 160
FT

3M Stock
7100184427
Previous 3M Stock
6105160
UPC
00840779165681
Alternative ID
6105160



3M™ DBI-SALA® Lad-Saf™
Swaged Cable 6104025, 3/8
Inch, 1x7, Galvanized Steel, 25
FT

3M Stock
7100184390
Previous 3M Stock
6104025
UPC
00840779165315
Alternative ID
6104025



3M™ DBI-SALA® Lad-Saf™
Swaged Cable 6104015, 3/8
Inch, 1x7, Galvanized Steel, 15
FT

3M Stock
7100184389
Previous 3M Stock
6104015
UPC
00840779165308
Alternative ID
6104015



3M™ DBI-SALA® Lad-Saf™
Swaged Cable 6104055, 3/8
Inch, 1x7, Galvanized Steel, 55
FT

3M Stock
7100184393
Previous 3M Stock
6104055
UPC
00840779165346
Alternative ID
6104055



**3M™ DBI-SALA® Lad-Saf™
Swaged Cable 6104045, 3/8
Inch, 1x7, Galvanized Steel, 45
FT**

3M Stock
7100184392
Previous 3M Stock
6104045
UPC
00840779165339
Alternative ID
6104045



**3M™ DBI-SALA® Lad-Saf™
Swaged Cable 6104110, 3/8
Inch, 1x7, Galvanized Steel, 110
FT**

3M Stock
7100184398
Previous 3M Stock
6104110
UPC
00840779165391
Alternative ID
6104110



**3M™ DBI-SALA® Lad-Saf™
Swaged Cable 6104075, 3/8
Inch, 1x7, Galvanized Steel, 75
FT**

3M Stock
7100184395
Previous 3M Stock
6104075
UPC
00840779165360
Alternative ID
6104075



**3M™ DBI-SALA® Lad-Saf™
Swaged Cable 6104130, 3/8
Inch, 1x7, Galvanized Steel, 130
FT**

3M Stock
7100184400
Previous 3M Stock
6104130
UPC
00840779165414
Alternative ID
6104130



**3M™ DBI-SALA® Lad-Saf™
Swaged Cable 6104170, 3/8
Inch, 1x7, Galvanized Steel, 170
FT**

3M Stock
7100184404
Previous 3M Stock
6104170
UPC
00840779165452
Alternative ID
6104170



**3M™ DBI-SALA® Lad-Saf™
Swaged Cable 6104160, 3/8
Inch, 1x7, Galvanized Steel, 160
FT**

3M Stock
7100184403
Previous 3M Stock
6104160
UPC
00840779165445
Alternative ID
6104160



**3M™ DBI-SALA® Lad-Saf™
Swaged Cable 6104220, 3/8
Inch, 1x7, Galvanized Steel, 220
FT**

3M Stock
7100184408
Previous 3M Stock
6104220
UPC
00840779165490
Alternative ID
6104220



**3M™ DBI-SALA® Lad-Saf™
Swaged Cable 6104200, 3/8
Inch, 1x7, Galvanized Steel, 200
FT**

3M Stock
7100184407
UPC
00840779165483
Alternative ID
6104200



**3M™ DBI-SALA® Lad-Saf™
Swaged Cable 6104190, 3/8
Inch, 1x7, Galvanized Steel, 190
FT**

3M Stock
7100184406
Previous 3M Stock
6104190
UPC
00840779165476
Alternative ID
6104190



**3M™ DBI-SALA® Lad-Saf™
Swaged Cable 6104260, 3/8
Inch, 1x7, Galvanized Steel, 260
FT**

3M Stock
7100184410
Previous 3M Stock
6104260
UPC
00840779165513
Alternative ID
6104260



**3M™ DBI-SALA® Standing
Seam Roof Anchor 2190073**

3M Stock
7100231994
Previous 3M Stock
2190073
UPC
00840779162123
Alternative ID
2190073



**3M™ DBI-SALA® Smart Lock
Self-Retracting Lifeline 3503875,
Stainless Steel Cable, 25 ft. (7.6
m)**

3M Stock
7100307004
UPC
00648250239421
Alternative ID
3503875



3M™ DBI-SALA® Smart Lock Edge Modular Self Retracting Lifeline 3503890, Galvanized Cable, Steel Swivel Snap Hook, 30 ft, ...

3M Stock
7100311418

Previous 3M Stock
3503890

UPC
00648250244531

Alternative ID
3503890



3M™ DBI-SALA® Smart Lock Edge Modular Self Retracting Lifeline 3503850, Galvanized Cable, Steel Swivel Snap Hook, 20 ft, ...

3M Stock
7100311416

Previous 3M Stock
3503850

UPC
00840779195923

Alternative ID
3503850



3M™ DBI-SALA® Smart Lock Self-Retracting Lifeline 3503874, 30 ft, Galvanized Cable, Class 1

3M Stock
7100306994

UPC
00648250239414

Alternative ID
3503874



3M™ DBI-SALA® Smart Lock Edge Self Retracting Lifeline 3503880, Galvanized Cable, Steel Swivel Snap Hook, 20 ft, Class 2

3M Stock
7100311415

UPC
00648250239476

Alternative ID
3503880



3M™ DBI-SALA® Smart Lock Edge Self Retracting Lifeline 3503881, Galvanized Cable, Steel Swivel Snap Hook, 30 ft, Class 2

3M Stock
7100311417

UPC
00648250239483

Alternative ID
3503881



3M™ DBI-SALA® Smart Lock Self-Retracting Lifeline 3503804, Stainless Steel Cable, Blue, 20 ft. (6m) 1 Ea/Case

3M Stock
7100204321

Previous 3M Stock
3503804

Alternative ID
3503804



3M™ Speedglas™ G5-01 Outer Flip-Up Welding Shield w Hinge Mech, Pivot Ring, and Outer Welding Visor Frame, 46-0099-34, 1 ...

3M Stock
7100214378
Previous 3M Stock
70071735719
UPC
00076308944650
Alternative ID
46-0099-34



3M™ Speedglas™ Auto-Darkening Filter ADF 100V 07-0001-31/37246 (AAD), Variable Shade 8-12, 1 EA/Case

3M Stock
7010342243
Previous 3M Stock
70071622586
UPC
00051131372467
Alternative ID
39113



3M™ Full Facepiece Reusable Respirator 6900DIN Large 4 EA/Case

3M Stock
7000126400
Previous 3M Stock
70070889822
UPC
50051138767032
Alternative ID
6900DIN



3M™ Full Facepiece Reusable Respirator 6800DIN, Medium 4 EA/Case

3M Stock
7000029682
Previous 3M Stock
70070889814
UPC
50051138767025
Alternative ID
6800DIN



3M™ Full Facepiece Reusable Respirator 6800 Medium 4 EA/Case

3M Stock
700002030
Previous 3M Stock
70070709053
UPC
50051138541465
Alternative ID
6800



3M™ Full Facepiece Reusable Respirator 6700 Small 4 EA/Case

3M Stock
700002029
Previous 3M Stock
70070709046
UPC
50051138541458
Alternative ID
6700



3M™ Full Facepiece Reusable Respirator 6700DIN Small 4 EA/Case

3M Stock
7000126399
Previous 3M Stock
70070889806
UPC
50051138767018
Alternative ID
6700DIN



3M™ Full Facepiece Reusable Respirator 6900 Large 4 EA/Case

3M Stock
7000002037
Previous 3M Stock
70070709186
UPC
50051138541595
Alternative ID
6900



3M™ Versaflo™ Easy Clean Backpack TR-927, 1 Ea/Case

3M Stock
7100300071
Alternative ID
TR-927



3M™ Versaflo™ Spark Arrestor TR-662, for TR-600/800 PAPR 2/BAG

3M Stock
7100035845
Previous 3M Stock
70071618253
UPC
00051131373556
Alternative ID
TR-662



3M™ PELTOR™ Optime™ 95 Earmuffs H6B/V, Behind-the-Head, 10 EA/Case

3M Stock
7000009666
Previous 3M Stock
XH001651211
UPC
10093045080622
Alternative ID
H6B/V



3M™ PELTOR™ Optime™ 95 Earmuffs H6A/V, Over-the-Head, 10 EA/Case

3M Stock
7000009667
Previous 3M Stock
XH001651229
UPC
10093045080615
Alternative ID
H6A/V



**3M™ DBI-SALA® Flexiguard™
Box-Frame Rail Adjustable
Height Anchor System 8530288,
2 User, 12 - 18 ft High, 12 ft
Wide**

3M Stock
7012820910
Previous 3M Stock
8530288
Alternative ID
8530288



**3M™ DBI-SALA® Confined
Space Carrying Bag for 3-Piece
Davit Base 8513565**

3M Stock
7100274753
Previous 3M Stock
8513565
UPC
00840779008841
Alternative ID
8513565



**3M™ DBI-SALA® Advanced™
Carrying Bag 8517565, 1 EA**

3M Stock
7100214172
Previous 3M Stock
8517565
UPC
00840779006342
Alternative ID
8517565



**3M™ DBI-SALA® Confined
Space Carrying Bag For Davit
Mast/Extension 8513564**

3M Stock
7010616062
Previous 3M Stock
8513564
UPC
00840779008834
Alternative ID
8513564



**3M™ DBI-SALA® Confined
Space Carrying Bag for 9 ft.
Aluminum Tripod 9503095**

3M Stock
7100240884
Previous 3M Stock
9503095
UPC
00840779007301
Alternative ID
9503095



**3M™ DBI-SALA® Confined
Space Carrying Bag Set For
5-Piece Davit Hoist 8518513**

3M Stock
7100280646
Previous 3M Stock
8518513
UPC
00840779005802
Alternative ID
8518513



3M™ DBI-SALA® Confined Space Carrying Bag for 7 ft Aluminum Tripod KK0RM3094

3M Stock
7100240883
Previous 3M Stock
9503094
UPC
00840779007295
Alternative ID
9503094



3M™ BX™ Protective Eyewear 11381-00000-20, Grey Anti-Fog Lens, Silver/Black Frame, 20 ea/Case

3M Stock
7000052796
Previous 3M Stock
70071539632
UPC
10078371620537
Alternative ID
11381-00000-20



3M™ BX™ Protective Eyewear 11380-00000-20, Clear Anti-Fog Lens, Silver/Black Frame, 20 ea/Case

3M Stock
7000052796
Previous 3M Stock
70071539624
UPC
10078371620520
Alternative ID
11380-00000-20



3M™ DBI-SALA® Web D-ring Extension Anchor 1231141, Polyester, 4 ft

3M Stock
7012817032
Previous 3M Stock
1231141
UPC
00840779040735
Alternative ID
1231141



3M™ DBI-SALA® Web D-ring Extension Anchor 1231156, Polyester, 6 ft

3M Stock
7012817033
Previous 3M Stock
1231156
UPC
00840779040773
Alternative ID
1231156

3M™ Probed Reusable Respirator Assembly 6200Q Medium 4 EA/Case

3M Stock
7000126030
Previous 3M Stock
70070317394
UPC
50051138289206
Alternative ID
6200Q



**3M™ DBI-SALA® Web D-ring
Extension Anchor 1231135,
Polyester, 3 ft**

3M Stock
7012817030
Previous 3M Stock
1231135
UPC
00840779040704
Alternative ID
1231135



**3M™ DBI-SALA® Web D-ring
Extension Anchor 1231123,
Polyester, 2 ft**

3M Stock
7012817028
Previous 3M Stock
1231123
UPC
00840779040643
Alternative ID
1231123



**3M™ DBI-SALA® Confined
Space Heavy-Duty Sleeve Cap
For Davit Mast Base 8510826,
Zinc Plated Steel**

3M Stock
7100280642
Previous 3M Stock
8510826
UPC
00840779005789
Alternative ID
8510826



**3M™ DBI-SALA® Confined
Space Heavy-Duty Sleeve Cap
For Davit Mast Base 8510827,
Stainless Steel**

3M Stock
7100278722
Previous 3M Stock
8510827
UPC
00648250238653
Alternative ID
8510827



**3M™ Protecta® Rope Lifeline
with Swivel Snap Hook 1299992,
5/8 in Polyester and
Polypropylene Blend, White, 75
ft**

3M Stock
7012529203
Previous 3M Stock
1299992
Alternative ID
1299992



**3M™ Protecta® Rope Lifeline
with Swivel Snap Hook 1299991,
5/8 in Polyester and
Polypropylene Blend, White, 30
ft**

3M Stock
7012817329
UPC
00840779078035
Alternative ID
1299991



3M™ DBI-SALA® SecuraSpan™ Rebar/Shear Stud HLL Stanchion with Base 7400215, 1 ea

3M Stock
7100220295
Previous 3M Stock
7400215
UPC
00840779004805
Alternative ID
7400215



3M™ DBI-SALA® Reusable Hinged Roof Anchor For Wood/Metal 2103676, with Fastener Kit

3M Stock
7100309981
Previous 3M Stock
2103676
UPC
00648250161845
Alternative ID
2103676



3M™ DBI-SALA® Roof Top Anchor - For Metal, Concrete, Wood Roofs 2100133, Silver

3M Stock
7100228409
Previous 3M Stock
2100133
UPC
00840779012602
Alternative ID
2100133



3M™ PROTECTA® PRO™ Knock-Down Disposable Roof Anchor 2103680, 12/Pack

3M Stock
7100221375
Previous 3M Stock
2103680
UPC
00840779011803
Alternative ID
2103680



3M™ Protecta® Pro™ Concrete Anchor Strap 2190057, 25 ea/Pack

3M Stock
7100232042
Previous 3M Stock
2190057
UPC
00076308400484
Alternative ID
2190057



3M™ Protecta® Pass-Thru Web Concrete Strap Anchor with D-ring 2190064, Polyester, 6 ft

3M Stock
7012818374
Previous 3M Stock
2190064
UPC
00840779067299
Alternative ID
2190064



3M™ Protecta® Pro™ Concrete Anchor Strap 2190063, 25 ea/Pack

3M Stock
7100232043
Previous 3M Stock
2190063
UPC
00076308400491
Alternative ID
2190063



3M™ 332 Impact Safety Goggles Anti-Fog 40651-00000-10, Clear Anti Fog Lens, 10 EA/Case

3M Stock
7000030007
Previous 3M Stock
70071542610
UPC
10078371621381
Alternative ID
40651-00000-10



3M™ Speedglas™ G5-02 Magnification Plate 08-0500-56, 1.5X

3M Stock
7100239738
Previous 3M Stock
70071736113
UPC
00076308944445
Alternative ID
08-0500-56



3M™ Lens Replacement FF-400-03, Replacement Part 5 EA/Case

3M Stock
7100009686
Previous 3M Stock
70071516861
UPC
50051135894755
Alternative ID
FF-400-03



3M™ Lens Assembly 6898/37006(AAD), Replacement Part 5 EA/Case

3M Stock
7000002036
Previous 3M Stock
70070709160
UPC
50051131370062
Alternative ID
6898



3M™ DBI-SALA® Nano-Lok™ Twin-Leg Fixed D-ring Connector 3100087, Zinc Plated Steel

3M Stock
7012818428
Previous 3M Stock
3100107
UPC
00840779012688
Alternative ID
3100107



**3M™ Filter Adapter 603, 100
ea/Case**

3M Stock
7100162621
Alternative ID
603



**3M™ Filter Adapter 502, 100
EA/Case**

3M Stock
7000001931
Previous 3M Stock
70070313211
UPC
50051138215113
Alternative ID
502



**3M™ Nose Cup Assembly
6894/37004(AAD), Replacement
Part 5 EA/Case**

3M Stock
7000002034
Previous 3M Stock
70070709145
UPC
50051131370048
Alternative ID
6894



**3M™ Nose Cup Assembly
FF-400-11, 5 EA/Case**

3M Stock
7000052741
Previous 3M Stock
70071516945
UPC
50051135894830
Alternative ID
FF-400-11



**3M™ Ultimate FX Full
Facepiece Reusable Respirator
FF-401, Small 4 EA/Case**

3M Stock
7000029940
Previous 3M Stock
70071510773
UPC
50051135894182
Alternative ID
FF-401



**3M™ Ultimate FX Full
Facepiece Reusable Respirator
FF-403, Large, 4 EA/Case**

3M Stock
7100001847
Previous 3M Stock
70071510831
UPC
50051135894243
Alternative ID
FF-403



3M™ Ultimate FX Full Facepiece Reusable Respirator FF-402 Medium 4 EA/Case

3M Stock
7000002284
Previous 3M Stock
70071510807
UPC
50051135894212
Alternative ID
FF-402



3M™ Protecta® PRO™ Eyebolt Anchor, Threaded AN112A

3M Stock
7100208214
Previous 3M Stock
AN112A
UPC
00648250140109
Alternative ID
AN112A



3M™ E-A-Rfit™ Dual-Ear Validation System 393-1100

3M Stock
7100062125
Previous 3M Stock
70071674116
UPC
00051141567648
Alternative ID
393-1100



3M™ PELTOR™ Hygiene Kit for Earmuffs HYX5/37284(AAD), Hearing Conservation, 10 Kits/Case

3M Stock
7000104049
Previous 3M Stock
XA007707616
UPC
04046719723645
Alternative ID
HYX5



3M™ PELTOR™ Hygiene Kit for Earmuffs HYX4/37283(AAD), Hearing Conservation, 10 Kits/Case

3M Stock
7000104048
Previous 3M Stock
XA007707608
UPC
04046719723591
Alternative ID
HYX4



3M™ PELTOR™ X2 Earmuffs X2A/37271(AAD), Over-the-Head, 10 EA/Case

3M Stock
7000104071
Previous 3M Stock
XA007707848
UPC
10093045937247
Alternative ID
X2A



3M™ PELTOR™ X2 Earmuffs X2P3E/37276(AAD), Hard Hat Attached, 10 EA/Case

3M Stock
7000104076
Previous 3M Stock
XA007707897
UPC
10093045937292
Alternative ID
X2P3E



3M™ PELTOR™ Hard Hat Attached Electrically Insulated Earmuffs X2P5E, 10 EA/Case

3M Stock
7100097448
Previous 3M Stock
UU007831728
UPC
10078371671010
Alternative ID
X2P5E



3M™ Hard Hat Terry Cloth Sweatband TCS1, White, For Use Over Standard Browpad, 10 ea/Case

3M Stock
7100213827
Previous 3M Stock
70071732203
UPC
50051131274933
Alternative ID
TCS1



3M™ DBI-SALA® EZ-Stop™ III Web Shock-Absorbing Lanyard 1244024, 6 ft

3M Stock
7012817118
Previous 3M Stock
1244024
UPC
00648250160985
Alternative ID
1244024



3M™ Versaflo™ Powered Air Purifying Respirator Unit TR-802N/94242(AAD), Intrinsically Safe 1 EA/Case

3M Stock
7100150821
UPC
00076308942427
Alternative ID
TR-802N



3M™ Chin Strap H-114-2 2/Case

3M Stock
7000052083
Previous 3M Stock
70070798056
UPC
50051138660906
Alternative ID
H-114-2



3M™ DBI-SALA® Temporary Loop Rebar Horizontal Lifeline Stanchion with Base 7400045

3M Stock
7012820224
Previous 3M Stock
7400045
UPC
00840779004713
Alternative ID
7400045



3M™ PROTECTA® PRO™ Confined Space Pulley AK020A1, 1 ea

3M Stock
7100220244
Previous 3M Stock
AK020A1
UPC
00648250110225
Alternative ID
AK020A1



3M™ DBI-SALA® Equipment Carrying and Storage Bag 9511597, 7.5 in x 6.5 in x 15.5 in

3M Stock
7100311235
Previous 3M Stock
9511597
UPC
00840779002818
Alternative ID
9511597



3M™ Hex Head Cap Screw 9501215, Stainless Steel, 1/2 in-13 x 3 in

3M Stock
7100310339
Previous 3M Stock
9501215
Alternative ID
9501215



3M™ DBI-SALA® Remote Power Tagline 8102101, 110 Volt, Galvanized Cable, 100 ft

3M Stock
7012776992
Previous 3M Stock
8102101
Alternative ID
8102101



3M™ Respirator Cleaning Wipe 504/07065(AAD), 500 EA/Case

3M Stock
7000001938
Previous 3M Stock
70070317139
UPC
50051131070658
Alternative ID
504



3M™ DBI-SALA® Confined Space Adjustable Ladder Bracket 8518506

3M Stock
7012820785
Previous 3M Stock
8518506
Alternative ID
8518506



3M™ DBI-SALA® Concrete Parapet Anchor 8523178, 1 ea

3M Stock
7100220317
Previous 3M Stock
8523178
UPC
00840779005819
Alternative ID
8523178



3M™ Speedglas™ 100/9002 Hard Hat Adapter 07-0014-00NR, for 3M™ Speedglas™ 100/9002 Welding Helmets, No Hard Hat

3M Stock
7100291856
UPC
00638060434789
Alternative ID
07-0014-00NR



3M™ Speedglas™ G5-01 Head Suspension Assembly, 46-0400-51, 1 EA/Case

3M Stock
7100259734
Previous 3M Stock
70071766557
UPC
00638060433386
Alternative ID
46-0400-51



3M™ Speedglas™ Hard Hat Adapter 9100 FX 06-0614-00NR, for 9100 FX Welding Helmets, No Hard Hat, 1 EA/Case

3M Stock
7000148536
Previous 3M Stock
70071622990
UPC
00051141561066
Alternative ID
06-0614-00NR



3M™ Rugged Comfort Half Facepiece Reusable Respirator 6502/49489, Medium, 10 EA/Case

3M Stock
7000128238
Previous 3M Stock
70071621836
UPC
50051131494898
Alternative ID
6502



3M™ Filter Retainer 501, 100 EA/Case

3M Stock
7100211073
UPC
50051138176681
Alternative ID
501



3M™ Universal Spectacle Kit 102, 1 ea/Case

3M Stock
7100254233
UPC
58887862383314
Alternative ID
102



3M™ Full Facepiece Reusable Respirator 7800S-M, Medium, Silicone 1 EA/Case

3M Stock
7000002045
Previous 3M Stock
70070710267
UPC
00051138542580
Alternative ID
7800S-M



3M™ Portable Compressed Air Filter and Reg Panel 256-02-00, 50 cfm, 4 outlets, w/Carbon Monoxide Filtration and Monitor 1...

3M Stock
7100009683
Previous 3M Stock
70070844074
Alternative ID
256-02-00



3M™ Versaflo™ Belt Extender TR-627X/37346(AAD), for TR-627 Easy Clean Belt

3M Stock
7100035834
Previous 3M Stock
70071618162
UPC
00051131373464
Alternative ID
TR-627X

3M™ Full Facepiece Reusable Respirator 7800S-L, Large, Silicone 1 EA/Case

3M Stock
7000126201
Previous 3M Stock
70070710275
UPC
00051138542597
Alternative ID
7800S-L



3M™ Versaflo™ High Durability Belt TR-626, for TR-600/800 PAPR, 1 EA/Case

3M Stock
7100035831
Previous 3M Stock
70071618139
UPC
00051131373433
Alternative ID
TR-626



3M™ Versaflo™ Easy Clean Belt TR-627/37345(AAD), for TR-600/800 PAPR

3M Stock
7100035833
Previous 3M Stock
70071618154
UPC
00051131373457
Alternative ID
TR-627



3M™ E-A-RLINK™ Foam Plug-With-Hole Eartips 5LS 420-2067, 3/4 Inch Height, Yellow, 500 EA/Case

3M Stock
7010296240
Previous 3M Stock
70071615960
UPC
10080529191264
Alternative ID
420-2067



3M™ E-A-RLINK™ Foam Eartips 3C 420-2028-5, with Black Tube, Large Size, Yellow, 24 EA/Case

3M Stock
7010384795
Previous 3M Stock
70071615945
UPC
10080529510065
Alternative ID
420-2028



3M™ PELTOR™ Optime™ 98 Earmuffs H9A, Over-the-Head, 10 EA/Case

3M Stock
7000009670
Previous 3M Stock
XH001651278
UPC
10093045080912
Alternative ID
H9A



3M™ Peltor™ Optime™ 98 Cap-Mount Earmuffs, Hearing Conservation H9P3E 10 EA/Case

3M Stock
7000002326
Previous 3M Stock
70071517059
UPC
10093045080936
Alternative ID
H9P3E



3M™ DBI-SALA® Flexiguard™ Counterweight Rail Fixed Height Anchor System with Concrete
8517763, 2 User, 22 ft High, 42 ft ...

3M Stock
7012777009
Previous 3M Stock
8517763
Alternative ID
8517763



3M™ DBI-SALA® SecuraSpan™ Pour-in-Place HLL Concrete Sleeve 7400201, 1 ea

3M Stock
7100220293
Previous 3M Stock
7400201
UPC
00840779004775
Alternative ID
7400201



3M™ DBI-SALA® Temporary Rebar/Shear Stud Horizontal Lifeline Intermediate Retro-Fit Kit
7400054

3M Stock
7012820228
Previous 3M Stock
7400054
UPC
00840779004751
Alternative ID
7400054



3M™ DBI-SALA® Lad-Saf™ X3 Detachable Cable Sleeve
6160054, 9.5MM

3M Stock
7100188819
UPC
00840779108480
Alternative ID
6160054



3M™ DBI-SALA® Rollgliss™ RPD 4:1 Ratio Rescue Positioning Device Kit 3602300, 3/8 in Nylon Kernmantle Rope, 300 ft

3M Stock
7012819488
Previous 3M Stock
3602300
Alternative ID
3602300



3M™ DBI-SALA® Rollgliss™ RPD Rescue Positioning Device, 4:1 Ratio 3602100, 1 EA

3M Stock
7100204311
Previous 3M Stock
3602100
UPC
00648250161197
Alternative ID
3602100



**3M™ DBI-SALA® Rollgliss™
RPD 4:1 Ratio Rescue
Positioning Device Kit 3602200,
3/8 in Nylon Kernmantle Rope,
200 ft**

3M Stock
7012819486
Previous 3M Stock
3602200
UPC
00840779051939
Alternative ID
3602200



**3M™ DBI-SALA® Rollgliss™
RPD 4:1 Ratio Rescue
Positioning Device Kit 3602150,
3/8 in Nylon Kernmantle Rope,
150 ft**

3M Stock
7012819485
Previous 3M Stock
3602150
UPC
00840779051847
Alternative ID
3602150



**3M™ DBI-SALA® Rollgliss™
RPD Rescue Positioning Device,
4:1 Ratio 3602050, 1 EA**

3M Stock
7100204312
Previous 3M Stock
3602050
UPC
00648250161180
Alternative ID
3602050



**3M™ Fit Test Adapter 601, 1
EA/Case**

3M Stock
7000001945
Previous 3M Stock
70070406544
UPC
00051138290184
Alternative ID
601



**3M™ PROTECTA® PRO™
Aluminum Tripod AK105A, 1 EA**

3M Stock
7100188839
Previous 3M Stock
AK105A
UPC
00648250111055
Alternative ID
AK105A



**3M™ DBI-SALA® ExoFit™
STRATA™ Tool Bag Hanger for
Harness 9512724, 40 lb
Capacity**

3M Stock
7100310706
Previous 3M Stock
9512724
Alternative ID
9512724



3M™ Spill Control 5-Gallon Safe Bucket with Hook and Loop Closure 1500135, 100 lb Capacity, Canvas

3M Stock
7100237394
Previous 3M Stock
1500135
UPC
00852684934801
Alternative ID
1500135



3M™ DBI-SALA® Safe Bucket 100 lb. Load Rated Hook and Loop Canvas 1500134, 1 EA

3M Stock
7100209335
UPC
00852684930292
Alternative ID
1500134



3M™ Utility Tool Pouch with Zipper Closure 1500130, Canvas, White

3M Stock
7100258403
Previous 3M Stock
1500130
UPC
00852684935112
Alternative ID
1500130



3M™ Spill Control Safe Bucket with Drawstring Closure 1500133, 100 lb Capacity, Canvas, 12.5 in dia x 15 in

3M Stock
7100270185
Previous 3M Stock
1500133
UPC
00852684930254
Alternative ID
1500133



3M™ Tool Pouch with D-ring 1500127, Canvas, Black, 8.75 in x 13 in

3M Stock
7012596550
Previous 3M Stock
1500127
UPC
00852684932487
Alternative ID
1500127



3M™ DBI-SALA® Parts Pouch, Vinyl Yellow 1500122, Small, 1 EA

3M Stock
7100214257
Previous 3M Stock
1500122
UPC
00852684932333
Alternative ID
1500122



3M™ Spill Control 2:1 Safe Bucket with Drawstring Closure 1500182, 100 lb Capacity, Canvas, 12.5 in dia x 16 in

3M Stock
7012818198
Previous 3M Stock
1500182
UPC
00840779173761
Alternative ID
1500182



3M™ Spill Control Hard-Body Safe Bucket Insert with Integrated Pockets 1500141

3M Stock
7100260276
Previous 3M Stock
1500141
UPC
00840779112333
Alternative ID
1500141



3M™ Spill Control Long Safe Bucket with Hook and Loop Closure 1500138, 100 lb Capacity, Canvas, 120 in

3M Stock
7100312708
Previous 3M Stock
1500138
UPC
00852684934788
Alternative ID
1500138



3M™ DBI-SALA® Long Safe Bucket 100 lb. Load Rated Hook and Loop Canvas 1500137, 1 ea

3M Stock
7100220234
Previous 3M Stock
1500137
UPC
00852684934764
Alternative ID
1500137



3M™ Tool Pouch with D-ring and Retractors 1500125, Canvas, Black, 7.5 in x 11 in

3M Stock
7010595550
UPC
00852684932418
Alternative ID
1500125



3M™ DBI-SALA® Parts Pouch, Canvas Black, Extra Deep 1500123, Small

3M Stock
7100157156
Previous 3M Stock
1500123
UPC
00852684932357
Alternative ID
1500123



3M™ DBI-SALA® Parts Pouch,
Canvas Orange 1500121, Small,
1 EA

3M Stock
7100214256
Previous 3M Stock
1500121
UPC
00852684932296
Alternative ID
1500121



3M™ DBI-SALA® Parts Pouch,
Canvas Camo 1500120, Small,
1 EA

3M Stock
7100214255
UPC
00852684932265
Alternative ID
1500120



3M™ DBI-SALA® Parts Pouch,
Canvas Black 1500119, Small

3M Stock
7100156938
Previous 3M Stock
1500119
UPC
00852684932241
Alternative ID
1500119



3M™ DBI-SALA® Roof Top
Anchor - For Standard
Membrane Roofs 2100139

3M Stock
7100228425
Previous 3M Stock
2100139
UPC
00840779012619
Alternative ID
2100139



3M™ DBI-SALA® Nano-Lok™
Web Adjustable Restraint
Lanyard 1231077, 1 EA

3M Stock
7100224724
Previous 3M Stock
1231077
UPC
00648250168103
Alternative ID
1231077



3M™ DBI-SALA® Adjustable
Web Positioning Lanyard for
Nano-Lok™ SRL 1231076, 3 ft

3M Stock
7012817016
Previous 3M Stock
1231076
UPC
00648250168097
Alternative ID
1231076



**3M™ DBI-SALA®
SecuraSpan™ Rebar/Shear
Stud Horizontal Lifeline System**
7400650, 50 ft. (15.2 m), 1 ea

3M Stock
7100220319
Previous 3M Stock
7400650
UPC
00840779004997
Alternative ID
7400650



**3M™ Solus™ Replacement
Foam Gasket, 10 ea/Bag**

3M Stock
7100079749
Previous 3M Stock
70071694551
Alternative ID
Solus-Foam



**3M™ SecureFit™, Replacement
Foam Gasket, SF-FOAM,
20/bag**

3M Stock
7100112132
Previous 3M Stock
70071675345
UPC
00051131274761
Alternative ID
SF-FOAM



**3M™ Solus™ 1000 Series
Replacement TPE Gasket
S1000-TPE, 20 ea/Case**

3M Stock
7100232857
Previous 3M Stock
70071734209
UPC
50638060429704
Alternative ID
S1000-TPE



**3M™ PELTOR™ LiteCom FRS
Headset MT53H7P3E4602-NA,
Hard Hat Attached, 10 ea/Case**

3M Stock
7100204440
UPC
07318640069688
Alternative ID
MT53H7P3E4602-
NA



**3M™ Secure Click™ Particulate
Filter N95 D7N11, 200 EA/Case**

3M Stock
7100213450
UPC
50051131278092
Alternative ID
D7N11



3M™ Adflo™ Powered Air Purifying Respirator Battery Promotional Kit 35-1099-17, 1 Kit EA/Case

3M Stock
7100025243
Previous 3M Stock
70071668068
UPC
00051141563305
Alternative ID
35-1099-17



3M™ PELTOR™ SCU-300 Attachment Clip TKD8003/1, 20 ea/Case

3M Stock
7100228539
UPC
07318640070936
Alternative ID
TKD8003/1



3M™ SecureFit™ Elevated Temperature Hard Hat



3M™ DBI-SALA® Fall Protection for Tools Body Tethers



3M™ PELTOR™ Probed Electronic Earplugs



3M™ SecureFit™ Hard Hat Replacement Brow-Pad SFH-700-BP, 20 ea/Case

3M Stock
7100247652
UPC
50638060429117
Alternative ID
SFH-700-BP



3M™ Hard Hat Replacement Brow-Pad H-700BP, 20 EA/Case

3M Stock
7000030093

Previous 3M Stock
70071614203

UPC
10078371654914

Alternative ID
H-700-BP



3M™ PELTOR™ WS™ LiteCom Plus Headset MT73H7A4610WS6NA, Headband, 5 ea/Case

3M Stock
7100204433

UPC
07318640069619

Alternative ID
MT73H7A4610WS6NA



3M™ PELTOR™ WS™ LiteCom Plus Headset MT73H7B4610WS6NA, Neckband, 5 ea/Case

3M Stock
7100204390

UPC
07318640069626

Alternative ID
MT73H7B4610WS6NA



3M™ PELTOR™ WS™ LiteCom Plus Headset MT73H7P3E4610WS6NA, Hard Hat Attached, 5 ea/Case

3M Stock
7100204436

UPC
07318640069633

Alternative ID
MT73H7P3E4610WS6NA



3M™ Tri-Flange™ Probed Test Plugs 393-2011-50, 10 Pair/Bag, 5 Bags EA/Case, 50 EA/Case

3M Stock
7000128263

Previous 3M Stock
70071647740

UPC
10093045937124

Alternative ID
393-2011-50



3M™ DBI-SALA® Fixed Ladder SRL Anchor



3M™ Scotchlite™ Reflective Material 9945 Series



3M™ DBI-SALA® Nano-Lok™ Self-Retracting Lifeline



3M™ SecureFit™ X5000 Series Short Visors



3M™ DBI-SALA® Incline Winch/SRL Adaptor Bracket

3M™ Scott™ Cylinders
Breathing Air Cylinders



- ☑ Available up to 5500 psig
- ☑ Light-weight carbon fiber design
- ☑ Up to 75 minute durations

3M™ Scott™ Cylinders
3M Stock
B5005047162



3M™ PELTOR™ Hard Hat Guide Arms Assembly P3EG-PK, 1 Pair/Case

3M Stock
7010384839

Previous 3M Stock
70071647641

UPC
00093045937202

Alternative ID
P3EG-PK



3M™ DBI-SALA® Lad-Saf™ Grab Bar Extension Top Bracket



3M™ DBI-SALA® Vehicle Hitch Mount Sleeve Davit Base



3M™ DBI-SALA® Suspension Seats



**3M™ PROTECTA® PRO™
Concrete D-ring Anchor with Bolt
2190055, 1 EA**

3M Stock
7100207457

UPC
00840779000760

Alternative ID
2190055



**3M™ Adflo™ Powered Air
Purifying Respirator System with
a Versaflo™ M-Series Helmet
and Speedglas™ Welding Shield
Upgrade...**



**3M™ Goggle Clip For Hard Hat,
46448-00000, 10 Pair/Case**

3M Stock
7000127229

Previous 3M Stock
70071521903

UPC
10078371464483

Alternative ID
46448-00000



**3M™ Powerflow™ High
Efficiency SP3 Particulate Filter
System Component
450-01-01R20 20 EA/Case**

3M Stock
7000131701

Previous 3M Stock
78812400030

UPC
50051138720037

Alternative ID
450-01-01R20



**3M™ Versaflo™ Heavy Duty
Holster TR-656, 1 EA/Case**

3M Stock
7100127543

Previous 3M Stock
70071676095

UPC
00051131275355

Alternative ID
TR-656



**3M™ Versaflo™ Easy Clean
Holster TR-657, 1 EA/Case**

3M Stock
7100127542

Previous 3M Stock
70071676087

UPC
00051131275348

Alternative ID
TR-657



3M™ DBI-SALA® Wall Mount Sleeve Davit Base



3M™ Professional Paint Respirator 7511PA1-A-PS, Small, 1/pk, 4 pks/cs

3M Stock
70006963030
UPC
00051131527645



3M™ Professional Paint Respirator 7513PA1-A-PS, Large, 1/pk, 4 pks/cs

3M Stock
70006963055
UPC
00051131527669



3M™ Professional Paint Respirator 7512PA1-A-PS, Medium, 1/pk, 4 pks/cs

3M Stock
70006963048
UPC
00051131527652



3M™ SECUREFIT™
HARD HAT NON-VENTED CAP STYLE

3M™ SecureFit™ Hard Hat CHH-R-W6-SL, Cap Style with Ratchet Adjustment, White, 6/Case

3M Stock
V101514154
UPC
00051131226692



3M™ SECUREFIT™
HARD HAT NON-VENTED CAP STYLE

3M™ SecureFit™ Hard Hat CHH-R-Y6-SL, Cap Style with Ratchet Adjustment, Yellow, 6/Case

3M Stock
V101514146
UPC
00051131226753



**3M™ SECUREFIT™
HARD HAT NON-VENTED FULL BRIM**

3M™ SecureFit™ Full Brim Hard Hat CHH-FB-R-W6-SL, with Ratchet Adjustment, White, 6/Case

3M Stock
V101553728

UPC
00051131226746



3M™ SecureFit™ Safety Helmet X5001X-ANSI, White, Reflective

3M Stock
70007073821

UPC
00051131225169



3M™ Aura™ Particulate Respirator 9205+

3M Stock
B00051022

UPC
00051131224766



3M™ Protective Coverall 4545



3M™ PELTOR™ ProTac Shooter Headset, Green, Headband

3M Stock
7100088425

Previous 3M Stock
UU004690630

UPC
04054596123168

Alternative ID
MT13H223A



3M™ PELTOR™ Lite-Com Pro II Power Supply for IS Battery FR08, 1 EA/Case

3M Stock
7000108521

Previous 3M Stock
XH001680194

UPC
07318640063044

Alternative ID
FR08



3M™ DBI-SALA® Confined Space One-Piece Offset Davit Mast



3M™ DBI-SALA® Pass-Thru Adjustable Web Tie-Off Adapter Anchor 1002110, Polyester, 10 ft

3M Stock
7012815113

Previous 3M Stock
1002110

UPC
00840779066605

Alternative ID
1002110



3M™ DBI-SALA® Pass-Thru Adjustable Web Tie-Off Adapter Anchor 1002120, Polyester, 20 ft

3M Stock
7012815116

Previous 3M Stock
1002120

UPC
00840779016433

Alternative ID
1002120



3M™ DBI-SALA® Pass-Thru Adjustable Web Tie-Off Adapter Anchor 1002130, Polyester, 30 ft

3M Stock
7012815117

Previous 3M Stock
1002130

UPC
00840779016440

Alternative ID
1002130



3M™ DBI-SALA® Flame Resistant Pass-Thru Web Tie-Off Adapter Anchor 1002207, Kevlar® Fiber, 12 ft

3M Stock
7012815122

Previous 3M Stock
1002207

UPC
00840779016518

Alternative ID
1002207



3M™ 334 Series Splash Safety Goggles



3M™ Speedglas™ 9100 Series
Welding Helmets



3M™ Welding Sweatbands



3M™ Speedglas™ G5-01
Starter Kit, 45-1101-99, 1
EA/Case

3M Stock
7100214377

UPC
00076308944872

Alternative ID
45-1101-99



3M™ Speedglas™ SL Auto-
Darkening Filter 05-0000-41,
Shade 8-12, 1 EA/Case

3M Stock
7010384893

Previous 3M Stock
70071401650

UPC
00051131985575

Alternative ID
05-0000-41



3M™ Nose Cup Valve Assembly
7882, Replacement Part 20
EA/Case

3M Stock
7000125976

Previous 3M Stock
70070079077

UPC
50021200603391

Alternative ID
7882



3M™ Bayonet Assembly
FF-400-08, 10 EA/Case

3M Stock
7000052739

Previous 3M Stock
70071516911

UPC
50051135894809

Alternative ID
FF-400-08



**3M™ Versaflo™ Prefilter
TR-6600/37354(AAD), for
TR-600 PAPR, 50 EA/Case**

3M Stock
7100021255
Previous 3M Stock
70071618246
UPC
50051131373544
Alternative ID
TR-6600



**3M(TM) Replacement
Cartridge/Filter Packout 07195,
Organic Vapor/P95**

3M Stock
7010341030
Previous 3M Stock
70070889863
UPC
00051131071957
Alternative ID
07195



**3M™ Organic Vapor Cartridge
07046**

3M Stock
7000002011
Previous 3M Stock
70070614709
UPC
00051131070462
Alternative ID
07046



**3M™ Prefilter TR-3600, for
Versaflo™ TR-300 PAPR 100
EA/Case**

3M Stock
7000127713
Previous 3M Stock
70071563640
UPC
50051131173694
Alternative ID
TR-3600



**3M™ Suspenders TR-329, for
Versaflo™ TR-300 &
Speedglas™ TR-300-SG PAPR,
1 EA/Case**

3M Stock
7100004866
Previous 3M Stock
70071563574
UPC
00051131173620
Alternative ID
TR-329



**3M™ Dual Airline Front-Mounted
Adapter Kit SA-1000 1 EA/Case**

3M Stock
7000126158
Previous 3M Stock
70070611580
UPC
00051138462703
Alternative ID
SA-1000



3M™ Combination Dual Airline Back-Mounted Adapter Kit SA-2100, High Pressure, 1 EA/Case

3M Stock
7000052039
Previous 3M Stock
70070710093
UPC
00051138542429
Alternative ID
SA-2100



3M™ Combination Dual Airline Back-Mounted Adapter Kit SA-2100LP, Low Pressure, 1 EA/Case

3M Stock
7000126198
Previous 3M Stock
70070710101
UPC
00051138542436
Alternative ID
SA-2100LP



3M™ Dual Airline Front-Mounted Adapter Kit SA-1000LP, Low Pressure 1 EA/Case

3M Stock
7000126159
Previous 3M Stock
70070611598
UPC
00051138462710
Alternative ID
SA-1000LP



3M™ E-A-Rfit™ Dual-Ear 1/4-20 to 5/8-27 Speaker Stand Adaptor 073-096

3M Stock
7100077868
Previous 3M Stock
70071674702
UPC
00078371670153
Alternative ID
073-096



3M™ Speedglas™ G5-03 Welding Helmet Powered Air System



3M™ Versaflo™ Size Reducing Ratchet Comfort Pad M-956/37327(AAD), 10 EA/Case

3M Stock
7000127693
Previous 3M Stock
70071562220
UPC
50051131373278
Alternative ID
M-956



3M™ Versaflo™ Comfort Pad for Premium Head Suspension, S-953, 20 EA/Case

3M Stock
7000127438
Previous 3M Stock
70071533429
UPC
50051131373056
Alternative ID
S-953



3M™ Versaflo™ Size Reducing Comfort Pad for Premium Head Suspension S-954, 20 EA/Case

3M Stock
7100010371
Previous 3M Stock
70071533437
UPC
50051131373063
Alternative ID
S-954



3M™ Speedglas™ G5-03 Pro-Air Welding Helmet 45-0099-35, No ADF, 1 EA/Case

3M Stock
7100306444
Previous 3M Stock
70100400004
UPC
00638060430507
Alternative ID
45-0099-35



3M™ Speedglas™ G5-03 Pro-Air Welding Helmet 45-0099-33, No Headband, No ADF, 1 EA/Case

3M Stock
7100312616
Previous 3M Stock
70100400210
UPC
00076308401795
Alternative ID
45-0099-33



3M™ DBI-SALA® Confined Space Aluminum Ladder Section 8518508, 4 ft

3M Stock
7012820787
Previous 3M Stock
8518508
Alternative ID
8518508



DBI-SALA SecuraSpan I-Beam Horizontal Lifeline System

3M Stock
B00036514



3M™ PROTECTA® Compliance in a Can™ Roofer's Fall Protection Kit

3M Stock
B00035926



3M™ DBI-SALA® Confined Space Winch with Power Drive Option



3M™ Safety Eyewear Gry Comfort, 90210-HV6-NA, Blk Frame Ylw Accent, AF & Scratch Resistant Lens, 6ea/case

3M Stock
70006984804
UPC
00638060081365



3M™ Safety Eyewear Clr Comfort, 90209-HV6-NA, Blk Frame Ylw Accent, AF & Scratch Resistant Lens, 6ea/case

3M Stock
70006984796
UPC
00638060081358



3M™ Safety Eyewear Silver Mirror, 90213-HZ4-NA, Blk Frame Gry Accent, AF & Scratch Resistant Lens, 4/cs

3M Stock
70006984838
UPC
00638060081396



3M™ Safety Eyewear 90212-HZ4, Gray Frame Yellow Accent, Clr/AF & Scratch Resistant Lens, 4/cs

3M Stock
70006984820
UPC
00638060081389



3M™ Nuvo™ Protective Eyewear 11411-00000-20, Clear Anti-Fog Lens, Grey Frame, 20 ea/Case

3M Stock
B00034325

UPC
10078371620599



3M™ Virtua™ Sport CCS Protective Eyewear



3M™ DBI-SALA® Rollgliss™ Rescue Pick-Off Strap

3M Stock
B00032535



3M™ PAPR Shrouds



3M™ Speedglas™ Heavy-Duty Welding Helmet G5-01 w 3M™ V-100 Vortex™ Cooling Valve Assembly, ADF VC, 46-5702-30iVC, 1 EA/Case

3M Stock
B5005188064

UPC
00638060433348



3M™ DBI-SALA® Aluminum Rope Pulley for Rollgliss™ 9504733

3M Stock
7100309558

UPC
00840779013623
Alternative ID
9504733



3M™ DBI-SALA® Edge Protector Bracket, Wind Energy Descent, 3320003

3M Stock
7100224718
UPC
00840779049301
Alternative ID
3320003



3M™ DBI-SALA® Rollgliss™ Sloped High Speed Automatic Descender Hardware Kit 3302977, Galvanized Steel Hook

3M Stock
7012818832
UPC
00840779073498
Alternative ID
3302977



3M™ DBI-SALA® Rollgliss™ Sloped High Speed Automatic Descender Hardware Kit 3302976, Stainless Steel Hook

3M Stock
7012818831
UPC
00840779073481
Alternative ID
3302976



3M™ DBI-Sala® Assisted Rescue Tool 3500100 for Ultra-Lok™, fork

3M Stock
7100208217
Previous 3M Stock
3500100
UPC
00840779002047
Alternative ID
3500100



3M™ DBI-SALA® Permanent Multi-Span Horizontal Lifeline System



3M™ PELTOR™ Replacement Headset PIC-100HD, 20 ea/Case

3M Stock
7100262876
UPC
00638060433096
Alternative ID
PIC-100HD



3M™ Secure Click™ Full Facepiece Reusable Respirator FF-801, Small, 4 EA/Case

3M Stock
7100261327

UPC
00638060432273

Alternative ID
FF-801



3M™ PELTOR™ Classics™ Replacement Tips 420-2097-50, Yellow, 50 EA/Case

3M Stock
7000128157

Previous 3M Stock
70071612918

UPC
10093045935496

Alternative ID
420-2097-50



3M™ PELTOR™ Earplug Connecting Cord, TEP-CORD, 5 EA/Case

3M Stock
7100074090

Previous 3M Stock
70071673795

UPC
00093045937837

Alternative ID
TEP-CORD



3M™ PELTOR™ Lite-Com Pro II Dynamic Throat Microphone MT90-02, 1 EA/Case

3M Stock
7000040037

Previous 3M Stock
XL001644068

UPC
04046719397938

Alternative ID
MT90-02



3M™ PELTOR™ Throat Microphone MT90, 1 ea/cs

3M Stock
7000127275

Previous 3M Stock
70071524550

UPC
00093045979219

Alternative ID
MT90



3M™ E-A-R™ EXPRESS™ Pod Plugs™ Earplugs 311-1127, Metal Detectable, Coded, Pillow Pack, 400 Pair/Case

3M Stock
7000127208

Previous 3M Stock
70071520830

UPC
10080529110524

Alternative ID
311-1127



3M™ E-A-R™ EXPRESS™ Pod Plugs™ Earplugs 321-2200, Uncorded, Assorted Color Grips, Pillow Pack, 400 Pair/Case

3M Stock
7000002308
Previous 3M Stock
70071515178
Alternative ID
321-2200



3M™ E-A-R™ EXPRESS™ Pod Plugs™ Earplugs 311-1115, Corded, Assorted Color Grips, Pillow Pack, 400 Pair/Case

3M Stock
7000127179
Previous 3M Stock
70071515194
UPC
10080529110111
Alternative ID
311-1115



3M™ E-A-R™ EXPRESS™ Pod Plugs™ Earplugs 311-1114, Corded, Blue Grips, Pillow Pack, 400 Pair/Case

3M Stock
7000002309
Previous 3M Stock
70071515202
UPC
10080529110104
Alternative ID
311-1114



3M™ E-A-R™ EXPRESS™ Pod Plugs™ Earplugs 321-2100, Uncorded, Blue Grips, Pillow Pack, 400 Pair/Case

3M Stock
7000127178
Previous 3M Stock
70071515186
UPC
10080529210002
Alternative ID
321-2100



3M™ Scotchlite™ Reflective Material 9586 Series



3M™ No Touch™ Probed Test Plugs, 393-2013-50, 50/PR

3M Stock
7100033339
Previous 3M Stock
70071650231
UPC
10093045937483
Alternative ID
393-2013-50



3M™ Head Strap/Harness Assembly 7893S, Silicone, 2 EA/Case

3M Stock
7000051828

Previous 3M Stock
70070221265

UPC
50051138213409

Alternative ID
7893S



3M™ Comfort Cradle Head Harness Attachment FF-400-06, 5 EA/Case

3M Stock
7000052737

Previous 3M Stock
70071516895

UPC
50051135894786

Alternative ID
FF-400-06



3M™ Rugged Comfort 6581 / 55886 Head Harness Assembly, System Component

3M Stock
7000128251

Previous 3M Stock
70071622396

UPC
50051141558863

Alternative ID
6581



3M™ Advanced Particulate Filter 2296, P100, with Nuisance Level Acid Gas Relief 100 EA/Case

3M Stock
7000127450

Previous 3M Stock
70071533965

UPC
50051131171713

Alternative ID
2296



3M™ Protecta® P50 Safety Harness



3M™ Welding Clear Visors/Plates



3M™ BX™ Dual Reader
Protective Eyewear
11458-00000-20, Clear Anti-Fog
Lens, Silver/Black Frame, +2.0
Top/Bottom Diopter, ...

3M Stock
7000127662
Previous 3M Stock
70071561271
UPC
10078371114586
Alternative ID
11458-00000-20



3M™ BX™ Reader Protective
Eyewear 11378-00000-20, Grey
Lens, Silver Frame, +2.0
Diopter, 20 ea/Case

3M Stock
7000127493
Previous 3M Stock
70071539608
UPC
10078371620506
Alternative ID
11378-00000-20



3M™ BX™ Reader Protective
Eyewear 11377-00000-20, Grey
Lens, Silver Frame, +1.5
Diopter, 20 ea/Case

3M Stock
7000127492
Previous 3M Stock
70071539590
UPC
10078371620490
Alternative ID
11377-00000-20



3M™ BX™ Dual Reader
Protective Eyewear
11457-00000-20, Clear Anti-Fog
Lens, Silver/Black Frame, +1.5
Top/Bottom Diopter. ...

3M Stock
7000127661
Previous 3M Stock
70071561263
UPC
10078371114579
Alternative ID
11457-00000-20



3M™ BX™ Reader Protective
Eyewear 11376-00000-20, Clear
Lens, Silver Frame, +2.5
Diopter, 20 ea/Case

3M Stock
7000127491
Previous 3M Stock
70071539582
UPC
10078371620483
Alternative ID
11376-00000-20



3M™ BX™ Reader Protective
Eyewear 11379-00000-20, Grey
Lens, Silver Frame, +2.5
Diopter, 20 ea/Case

3M Stock
7000127494
Previous 3M Stock
70071539616
UPC
10078371620513
Alternative ID
11379-00000-20



3M™ BX™ Dual Reader Protective Eyewear
 11459-00000-20, Clear Anti-Fog Lens, Silver/Black Frame, +2.5 Top/Bottom Diopter, ...

3M Stock
 7000127663
 Previous 3M Stock
 70071561289
 UPC
 10078371114593
 Alternative ID
 11459-00000-20



3M™ BX™ Reader Protective Eyewear 11375-00000-20, Clear Lens, Silver Frame, +2.0 Diopter, 20 ea/Case

3M Stock
 7000052794
 Previous 3M Stock
 70071539574
 UPC
 10078371620476
 Alternative ID
 11375-00000-20



3M™ PELTOR™ WS™ ProTac XPI Headsets



3M™ Medium Quick Ring Tool Attachment Point 1500025, 2 lb Capacity, 1 in, 25 ea/Pack

3M Stock
 7100275356
 UPC
 00852684932579
 Alternative ID
 1500025



3M™ Hook2Quick-Ring Coil Tool Tether with Tail 1500065, 2 lb Capacity, 3 - 62 in

3M Stock
 7100270184
 UPC
 00852684930988
 Alternative ID
 1500065



3M™ Dual Wing Cinch Tool Attachment Point 1500015, 35 lb Capacity

3M Stock
 7100260275
 UPC
 00852684932968
 Alternative ID
 1500015



**3M™ DBI-SALA® Quick Wrap
Tape II 1500171, Blue 1"x216"**

3M Stock
7100204331
UPC
00840779151332
Alternative ID
1500171



**3M™ Dual Wing Cinch Tool
Attachment Point 1500017, 80 lb
Capacity**

3M Stock
7100241914
UPC
00852684934580
Alternative ID
1500017



**3M™ Single Wing Cinch Tool
Attachment Point 1500013, 35 lb
Capacity**

3M Stock
7100258130
UPC
00852684932920
Alternative ID
1500013



**3M™ Cinch Tool Attachment
Point 1500011, 35 lb Capacity**

3M Stock
7012818069
UPC
00852684933002
Alternative ID
1500011



**3M™ DBI-SALA® D-Ring
Attachment with Cord 1500009,
10 EA/PACK**

3M Stock
7100214245
UPC
00852684930735
Alternative ID
1500009



**3M™ DBI-SALA® D-ring
Attachment 0.5" x 2.25"
1500003, 10 EA/PACK**

3M Stock
7100214250
UPC
00852684930636
Alternative ID
1500003



3M™ Scott™ Airline Hose Assemblies



3M™ X5-REFKIT reflective sticker kit for SecureFit™ Safety Helmet 10 KITS /CASE

3M Stock
7100175590
UPC
04054596595521
Alternative ID
X5-REFKIT



3M™ H-700 Cap Style and H-800 Full Brim Series Hard Hat Scotchlite™ Reflective Striping Kit H-SR-S, 20 each set

3M Stock
7010341312
Previous 3M Stock
70071674488
UPC
00078371670238
Alternative ID
H-SR-S



3M™ Skull Screws™ Probed Test Plugs 393-2012-50, 50 pair/case, 10 pair/bag, 5 bags/case

3M Stock
7000128264
Previous 3M Stock
70071647757
UPC
10093045937131
Alternative ID
393-2012-50



3M™ E-A-R™ UltraFit™ 27 Earplugs 340-8001, Uncorded, 400 Pair/Case

3M Stock
7000127189
Previous 3M Stock
70071515764
UPC
10080529400540
Alternative ID
340-8001



3M™ E-A-R™ UltraFit™ 27 Earplugs 340-8002, Corded, 400 Pair/Case

3M Stock
7000127188
Previous 3M Stock
70071515756
UPC
10080529400557
Alternative ID
340-8002



3M™ DBI-SALA® FlexiGuard™
M200 Adjustable Height Mast



3M™ SecureFit™ 100 Series
Safety Glasses



3M™ Scott™ EPIC 3 Voice
Amplifier

3M Stock
B5005218009



3M™ DBI-SALA® Lad-Saf™
Mobile Rope Grab Kit



3M™ X5-S4PTCS1 Standard 4
Point Chin Strap with buckle for
SecureFit™ Safety Helmet

3M Stock
7100207831
UPC
50076308944983
Alternative ID
X5-S4PTCS1



3M™ Powered & Supplied Air
Breathing Tubes



3M™ Scott™ Air-Pak™ 75i
SCBA

3M Stock
B5005047165



3M™ Scott™ E-Z Airline
Supplied Air Respirator

3M Stock
B5005047149



**3M™ PELTOR™ Replacement
Case TEP-300C GE, Gray, 20
ea/Case**

3M Stock
7100227638

Previous 3M Stock
70071734365

UPC
00638060429990

Alternative ID
TEP-300C GE



**3M™ PELTOR™ Replacement
Case TEP-300C CY, Coyote
Brown, 20 ea/Case**

3M Stock
7100227630

Previous 3M Stock
70071734357

UPC
00638060430019

Alternative ID
TEP-300C CY



**3M™ DBI-SALA® Lad-Saf™
Static Wire Rope Grab 5000338,
1 EA**

3M Stock
7100207470

UPC
00840779003792

Alternative ID
5000338



**3M™ Scott™ RIT-Pak III
Emergency Air Supply System**

3M Stock
B5005047164



3M™ DBI-SALA® SSB Cable
Climb Assist System Lifeline
Assembly 3512150, 1/4 in
Galvanized Steel 7 x 19, 150 ft

3M Stock
7012819331

UPC
00840779071180

Alternative ID
3512150



3M™ DBI-SALA® SSB Cable
Climb Assist System Lifeline
Assembly 3512300, 1/4 in
Galvanized Steel 7 x 19, 300 ft

3M Stock
7012819341

UPC
00840779071586

Alternative ID
3512300



3M™ DBI-SALA® SSB Cable
Climb Assist System Lifeline
Assembly 3512100, 1/4 in
Galvanized Steel 7 x 19, 100 ft

3M Stock
7012819326

UPC
00840779070909

Alternative ID
3512100



3M™ DBI-SALA® SSB Cable
Climb Assist System Lifeline
Assembly 3530150, 1/4 in
Stainless Steel 7 x 19, 150 ft

3M Stock
7012819382

Previous 3M Stock
3530150

Alternative ID
3530150



3M™ DBI-SALA® SSB Cable
Climb Assist System Lifeline
Assembly 3530300, 1/4 in
Stainless Steel 7 x 19, 300 ft

3M Stock
7012819384

Alternative ID
3530300



3M™ DBI-SALA® SSB Cable
Climb Assist System Lifeline
Assembly 3512350, 1/4 in
Galvanized Steel 7 x 19, 350 ft

3M Stock
7012819344

UPC
00840779071654

Alternative ID
3512350



3M™ DBI-SALA® Confined Space Bare Steel Uni-Anchor with Tie-Off 8517412
 3M Stock
 7100157154
 UPC
 00840779002306
 Alternative ID
 8517412



3M™ DBI-SALA® Bare Steel Uni-Anchor 8510816
 3M Stock
 7100157153
 UPC
 00840779004034
 Alternative ID
 8510816



3M™ DBI-SALA® Rollgliss™ 3:1 Rescue Positioning Device



3M™ DBI-SALA® Rollgliss™ Staggered Step Rescue Ladder 8516294, Web, 8 ft
 3M Stock
 7012595692
 UPC
 00840779074037
 Alternative ID
 8516294



3M™ PELTOR™ CH-5 High Attenuation Headset - MT73H450A-86 - NATO Wired - Headband - 31dB NRR
 3M Stock
 7100099883
 UPC
 07318640067066
 Alternative ID
 MT73H450A-86



3M™ PELTOR™ CH-5 High Attenuation Headset - MT73H450P3E-77 GB - Flex Connector - Hard Hat Attached - 29dB NRR
 3M Stock
 7100099881
 UPC
 07318640067073
 Alternative ID
 MT73H450P3E-77
 GB



**3M™ Speedglas™ Welding
Helmet Cleaning Wipe 130100,
2/Bag**

3M Stock
7100243075
Previous 3M Stock
70071765534
UPC
00076308944483
Alternative ID
130100



**3M™ Pomp Plus™ Probed Test
Plugs 393-2017-50, 50
Pair/Case**

3M Stock
7010301959
Previous 3M Stock
70071673142
UPC
10078371666085



**3M™ E-A-R™ Push-Ins™
SofTouch™ Earplugs 318-4001,
Corded, Poly Bag, 2000
Pair/Case**

3M Stock
7000127215
Previous 3M Stock
70071520988
UPC
10080529180183
Alternative ID
318-4001



**3M™ Remote Alarm & Strobe
529-05-20, Audible, 1 EA/Case**

3M Stock
7000131708
Previous 3M Stock
78812400162
UPC
00051138720162
Alternative ID
-500606



**3M™ Thumbscrew Clamp
W-5102-2, 2/Case**

3M Stock
7000130672
Previous 3M Stock
78800751816
UPC
50051138153194
Alternative ID
W-5102-2



**3M™ Speedglas™ Welding
Filter 9002NC 04-0000-21NC, 1
EA/Case**

3M Stock
7010386299
UPC
00051131276093

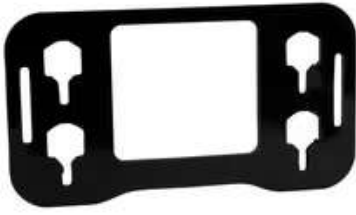

3M™ Versaflo™ Back Pack Adaptor TR-655/37385 (AAD), for TR-600/800 PAPR, 1 EA

3M Stock
7100035843
Previous 3M Stock
70071651692
UPC
00051131373853
Alternative ID
TR-655



3M™ E-A-R™ One Touch™ Pro Earplug Dispensing Mechanism, 391-0011, 1 ea/Case

3M Stock
7010528303
UPC
00051131277489
Alternative ID
391-0000



3M™ E-A-R™ One Touch™ Pro Adapter Plate 391-0010

3M Stock
7100077665
Previous 3M Stock
70071674744
UPC
00078371670504
Alternative ID
391-0010



3M™ DBI-SALA® Floor Mount Cast-in-Place Sleeve Davit Base



3M™ Versaflo™ M-Series Helmet Cover M-978, 1 EA/Case

3M Stock
7100168652
UPC
00076308942793
Alternative ID
M-978



3M™ Safety Eyewear Anti-Scratch, 90953H1-DC-20, Clear, Clear Lens, 20/case

3M Stock
70006987963
UPC
00051141332185



3M™ Indoor Safety Eyewear, 90953-BU10-NA, Clear Frame/Clear Scratch Resistant Lens, 10 eaches/case

3M Stock
70006947397
UPC
00078371908379



3M™ Eyeglass Protectors Anti-Scratch, 47031H1-DC, Clear, Clear Lens, 6/case

3M Stock
70006987930
UPC
00051141981185



3M™ Over-the-Glass Eyewear Anti-Scratch, 47110H1-DC, Clear, Clear Lens, 24/case

3M Stock
70006982733
UPC
00076308729943



3M™ Eyeglass Protectors Anti-Scratch, 47032H1-DC, Gray, Gray Lens, 6/case

3M Stock
70006987948
UPC
00051141981178



3M™ Over-the-Glass Eyewear, 47110G1-DC, Clear, Clear Lens, 6/case

3M Stock
70006987823
UPC
00638060080788



3M™ Over-the-Glass Eyewear, 47110H1-C, Clear, Clear Lens, Anti-Scratch, 10/case

3M Stock
70006985348
UPC
00076308729943



**3M™ PELTOR™ Level
Dependent Earplug, LEP-200**

3M Stock
7010316631

UPC
00093045938254

Alternative ID
LEP-200



**3M™ PELTOR™ Electronic
Earplug, EEP-100**

3M Stock
7100193144

UPC
00051131277434

Alternative ID
EEP-100



**3M™ Scott™ RIT-Pak Fast
Attack Emergency Air Supply
System**

3M Stock
B5005047168



**3M™ Scott™ Ska-Pak Plus
Supplied-Air Respirator**

3M Stock
B5005047151



**3M™ Scott™ EPIC 3 RI Voice
Communication System**

3M Stock
B5005046023



**3M™ Versaflo™ Visor
Attachment Clips (Left and
Right) for Premium Head
Suspension, S-952 1 Pair/Case**

3M Stock
7100077600

Previous 3M Stock
70071533411

UPC
00051131373044

Alternative ID
S-952



3M™ Versaflo™ Cleaning & Storage Kit TR-653/37373(AAD), for TR-600/800 PAPR, 1 EA/Case

3M Stock
7100035841
Previous 3M Stock
70071618428
UPC
00051131373730
Alternative ID
TR-653



3M™ Adflo™ High Efficiency Starter Kit 15-1101-99/37147(AAD), 1 EA/Case

3M Stock
7000126735
Previous 3M Stock
70071268554
UPC
00051131371477
Alternative ID
15-1101-99



3M™ Versaflo™ Premium Visor M-927/37324(AAD), 5 EA/Case

3M Stock
7000052876
Previous 3M Stock
70071562188
UPC
00051131373242
Alternative ID
M-927



3M™ Versaflo™ Battery Adapter TR-659, 1 EA/Case

3M Stock
7100127544
Previous 3M Stock
70071676103
UPC
00051131275362
Alternative ID
TR-659



3M™ Breathe Easy™ Battery Adapter Upgrade Kit RBE-600, 1 EA/Case

3M Stock
7100144938
Previous 3M Stock
70071676129
UPC
00051131275386
Alternative ID
RBE-600



3M™ DBI-SALA® Rollgliss™ R550 Edge Protector 3320046

3M Stock
7012818868
UPC
03660570058336
Alternative ID
3320046



3M™ DBI-SALA® Permanent Roof Top Anchor For Single Ply Bitumen Membrane/Built-Up 2100142, with Weather Proof Shroud

3M Stock
7100314285

UPC
00840779013388

Alternative ID
2100142



3M™ Mold Remediation Respirator Kit 68097, Medium 2 Kits EA/Case

3M Stock
7000144916

Previous 3M Stock
70071090206

UPC
50051131527923

Alternative ID
68097



3M™ Mold Remediation Respirator Kit 69097, Large 2 Kits EA/Case

3M Stock
7010316002

Previous 3M Stock
70071090214

UPC
50051131527930

Alternative ID
68097



FUTURO™ Performance Compression Arm Sleeve

3M Stock
CBGBLRUS1488

UPC
00051131204935



3M™ Pro-Grade Earmuff 90565-4DC-PS, 4 each/case

3M Stock
CBGNAWUS1742

UPC
00076308873356



Peltor™ Sport Bull's Eye™ Hearing Protector, 97041-PEL-6C, 27 NRR Black/Gray

3M Stock
CBGNARUS2507

UPC
00051125005654



3M™ ANSI Class 2 Two-Tone Safety Vest, Yellow

3M Stock
CBGNAWUS2197

UPC
00051141376646



3M™ Replacement Cartridges for Household Multi-purpose Respirator 60921HB1-A, 1 pr/pk, 5 packs/cs

3M Stock
CBGNAW011187

UPC
00051141900230



3M™ Non-vented Hard Hat with Pinlock Adjustment, Yellow 91296-80025T 12/case

3M Stock
CBGNAW011117

UPC
10078371612303



3M™ 2091 Performance Filter P100 for 3M™ Reusable Respirators

3M Stock
CBGNAW011096

UPC
00051131070004



3M™ Cool Flow™ Valve Particulate Respirator 8511

3M Stock
CBGNAW011077

UPC
00051131917576



FUTURO™ Dress Socks for Men, Firm Compression

3M Stock
CBGBLW011019

UPC
00051131215771



**3M™ DBI-SALA® Confined
Space Portable Extendable Pole
Hoist 8560476, Stainless Steel
Hardware, 6 ft - 10 ft**

3M Stock
7100311856
Previous 3M Stock
8560476
Alternative ID
8560476



**3M™ DBI-SALA® Confined
Space Pole Hoist System
8530253**

3M Stock
7100188846
Alternative ID
8530253



**3M™ DBI-SALA® Clamp-On
Anchor With Vertical/Horizontal
Flange Up To 6" Thick 1
EA/Case**

3M Stock
7100204058
Alternative ID
8520777



**3M™ DBI-SALA® Confined
Space Portable Extendable Pole
Hoist T-Bar Leg Assembly
8561235, Stainless Steel
Hardware**

3M Stock
7100311857
Previous 3M Stock
8561235
Alternative ID
8561235



**3M™ DBI-SALA® Confined
Space Pole Hoist System
8530252**

3M Stock
7100188845
UPC
00840779009176
Alternative ID
8530252



**3M™ Air Inlet Gasket 7999,
Replacement Part 10 EA/Case**

3M Stock
7000051843
Previous 3M Stock
70070313443
UPC
50021200603834
Alternative ID
7999



3M™ Inhalation Port Gasket 7887, Replacement Part 20 EA/Case

3M Stock
7000125979
Previous 3M Stock
70070079127
UPC
50021200603285
Alternative ID
7887

3M™ Lens Gasket 7992/7992-AM, 1 EA/Case

3M Stock
7000126526
Previous 3M Stock
70071090339
UPC
00051131528000
Alternative ID
7992/7992-AM

3M™ DBI-SALA® I-Beam Trolley Anchor 2103147, Stainless Steel, Fits 3 - 8 in Wide, 11/16 in Thick

3M Stock
7100260111
Previous 3M Stock
2103147
UPC
00840779011773
Alternative ID
2103147



3M™ Formaldehyde Organic Vapor Cartridge/Filter 60925, P100 60 EA/Case

3M Stock
7000126166
Previous 3M Stock
70070614527
UPC
50051138464696
Alternative ID
60925

3M™ Acid Gas Cartridge/Filter 60922, P100 60 EA/Case

3M Stock
7000126165
Previous 3M Stock
70070614493
UPC
50051138464665
Alternative ID
60922

3M™ Speedglas™ G5-03 Pro Welding Helmets



3M™ Protective Coverall 4565



3M™ Versaflo™ Premium Holder V-112, for V-100 and V-200 Series Air Regulating Valves

3M Stock
7100091678

Previous 3M Stock
70071674033

UPC
00051131374157

Alternative ID
V-112



3M™ SA-Series Supplied Air Regulator Valves & Assemblies



3M™ DBI-SALA® D-ring Anchorage Plate 2101636

3M Stock
7100230111

Previous 3M Stock
2101636

UPC
00648250162477

Alternative ID
2101636



3M™ Replacement Clear Chin Protector CP8 82542-00000 10 EA/Case

3M Stock
7000127233

Previous 3M Stock
70071521994

UPC
10078371825420

Alternative ID
82542-00000



3M™ Versaflo™ Vortex Muffler Kit V-111 1 EA/Case

3M Stock
7000126273

Previous 3M Stock
70070799039

UPC
00051138661601

Alternative ID
V-111



3M™ DBI-SALA® D-Ring Plate Anchor 2101634, Raw Steel Plate, Zinc Plated Steel D-Ring

3M Stock
7100246177
UPC
00648250161814
Alternative ID
2101634



3M™ Versaflo™ Vortemp™ Muffler Kit V-211 1 EA/Case

3M Stock
7000126276
Previous 3M Stock
70070799112
UPC
00051138661687
Alternative ID
V-211



3M™ DBI-SALA® Vacuum Anchor with Air Bottle Attachment 2200108

3M Stock
7100226831
UPC
00840779000975
Alternative ID
2200108



3M™ Protecta® Cable Tie-Off Adaptor



3M™ Speedglas™ 9100 QR Welding Helmet 06-0300-52QR, No Rail, Hard Hat and ADF, 1 EA/Case

3M Stock
7100200560
UPC
00076308943776
Alternative ID
06-0300-52QR



3M™ Unthreaded Anchorage Ring 9501683, Zinc Plated Steel, 13 mm

3M Stock
7100310347
Alternative ID
9501683



3M™ DBI-SALA® D-ring Bolt Anchor For Concrete 2104568, Fits 11/16 in, 18 mm or 3/4 in Hole

3M Stock
7012818335
Previous 3M Stock
2104568
Alternative ID
2104568



3M™ DBI-SALA® Pass-Thru Web Concrete Strap Anchor with D-ring 2100055, Polyester, 6 ft

3M Stock
7012818239
Previous 3M Stock
2100055
UPC
00840779047178
Alternative ID
2100055



3M™ DBI-SALA® Pass-Thru Web Concrete Strap Anchor with D-ring 2100148, Polyester, 12 ft

3M Stock
7012818255
Previous 3M Stock
2100148
Alternative ID
2100148



3M™ GoggleGear™ 2890 Series Safety Goggles



3M™ Adflo™ Powered Air Purifying Respirator System with 3M™ Speedglas™ 9100-Air Welding Helmet



3M™ Speedglas™ 9100 FX Series Welding Helmets



**3M™ Speedglas™ Welding
Helmet Outer Shield
27-0099-68, for 9100MP, 1
EA/Case**

3M Stock
7000128226
Previous 3M Stock
70071621612
UPC
00051141558158
Alternative ID
27-0099-68



**3M™ Speedglas™ Welding
Helmet Inner Shield 27-0099-63,
for 9100MP, 1 EA/Case**

3M Stock
7000128225
Previous 3M Stock
70071621604
UPC
00051141558141
Alternative ID
27-0099-63



**3M™ Speedglas™ Rail
Retention Parts 06-0114-00QR,
1 EA/Case**

3M Stock
7100031971
Previous 3M Stock
70071669066
UPC
00051141563688
Alternative ID
06-0114-00QR



**3M™ Speedglas™ Rail
06-0014-00QR, Quick Release,
1 EA/Case**

3M Stock
7100031970
Previous 3M Stock
70071669058
UPC
00051141563671
Alternative ID
06-0014-00QR



**3M™ Speedglas™ G5-02
Welding Helmet Shell
08-0300-52, Without Front
Cover, Headband and ADF, 1
ea/Case**

3M Stock
7100239735
Previous 3M Stock
70071736055
UPC
00076308944384
Alternative ID
08-0300-52



**3M™ Speedglas™ 9100 Battery
Holder 06-0400-55/37190(AAD),
2 EA/Case**

3M Stock
7010385094
Previous 3M Stock
70071510336
UPC
00051131371903
Alternative ID
06-0400-55



3M™ Speedglas™ 9100 Battery Holder 06-0400-55-B, 10 EA/Case
 3M Stock
 7000127157
 UPC
 50051135894014
 Alternative ID
 06-0400-55-B



3M™ Speedglas™ Battery Holder 04-0380-00, Blue, 2 EA/Case
 3M Stock
 7000126764
 Previous 3M Stock
 70071272952
 UPC
 50051131930419
 Alternative ID
 04-0380-00



3M™ Speedglas™ Battery Holder SL 05-0370-00, 1 EA/Case
 3M Stock
 7000126944
 Previous 3M Stock
 70071401718
 UPC
 00051131985636
 Alternative ID
 05-0370-00



3M™ Speedglas™ 9100 Welding Helmet Front Panel 06-0300-55-B, Silver, 5 EA/Case
 3M Stock
 7000128244
 Previous 3M Stock
 70071621901
 UPC
 50051131494959
 Alternative ID
 06-0300-55-B



3M™ Speedglas™ 9100 FX-Air Air Diffuser 06-0700-85, 1 EA/Case
 3M Stock
 7000128096
 Previous 3M Stock
 70071606845
 UPC
 00051131497252
 Alternative ID
 06-0700-85



3M™ Speedglas™ 9100 QR Spacer Bar 06-0119-00QR, 1 EA/Case
 3M Stock
 7100031975
 Previous 3M Stock
 70071667938
 UPC
 00051141563541
 Alternative ID
 06-0119-00QR



**3M™ Speedglas™ 9100
Welding Helmet Front Panel
06-0300-55, Silver, 1 EA/Case**

3M Stock
7000128243

Previous 3M Stock
70071621893

UPC
00051131494947

Alternative ID
06-0300-55



**3M™ Speedglas™ 100 Series
Front Frame 07-0212-00SV,
Silver, 1 EA/Case**

3M Stock
7000127445

Previous 3M Stock
70071533858

UPC
00051131171572

Alternative ID
07-0212-00SV



**3M™ Probed Particulate
Respirator 8233Q, N100 20
EA/Case**

3M Stock
7010315854

Previous 3M Stock
70070797546

UPC
50051138660845

Alternative ID
8233Q



**3M™ Speedglas™ 9000
Welding Helmet Front Panel
04-0212-02NC, 1 EA/Case**

3M Stock
7100140486

Previous 3M Stock
70071677341

UPC
00051131276109



**3M™ Speedglas™ G5-01 Inner
Grinding Visor Frame,
46-0700-64, 1 EA/Case**

3M Stock
7100214394

UPC
00076308944629

Alternative ID
46-0700-64



**3M™ Protecta® P200 Safety
Harness**



3M™ Virtua™ CCS Protective Eyewear with Foam Gasket, VC215AF Clear +1.5D Anti-Fog Lens, 20 ea/Case

3M Stock
7100046796
Previous 3M Stock
70071654084
UPC
10078371662698
Alternative ID
VC215AF



3M™ Virtua™ CCS Protective Eyewear with Foam Gasket, VC225AF Clear +2.5D Anti-Fog Lens, 20 ea/Case

3M Stock
7100046673
Previous 3M Stock
70071654100
UPC
10078371662711
Alternative ID
VC225AF



3M™ Dual Cartridge Respirator Assembly 07191, Organic Vapor/P95, Small

3M Stock
7000126245
Previous 3M Stock
70070797850
UPC
00051131071919
Alternative ID
07191



3M™ Speedglas™ 9100 Series Auto-Darkening Welding Filters

3M™ Bayonet Cap 6880/37002(AAD), 10 ea/Bag

3M Stock
7100006233
Previous 3M Stock
70070757375
UPC
50051131370024
Alternative ID
6880



3M™ Full Face Paint Project Respirator, 68P71P1-DC, Size Medium, 1 each/pack, 2 packs/case

3M Stock
70006986320
UPC
00051138660567



3M™ Full Face Reusable Paint Project Respirator OV/P95, 69P71P1-DC, Large, 1 each/pack, 2 packs/case

3M Stock
70006985637
UPC
00051138660574



3M™ Secure Click™ Exhalation Valve Cover Assembly FF-800-04, 5 ea/Case

3M Stock
7100267864
Previous 3M Stock
70071765716
UPC
00638060432259
Alternative ID
FF-800-04



3M™ Replacement Filter Kit 523-01-28 1 EA/Case

3M Stock
7100006947
Previous 3M Stock
78812400097
Alternative ID
-502910



3M™ Exhalation Valve Assembly FF-400-07, 5 EA/Case

3M Stock
7000052738
Previous 3M Stock
70071516903
UPC
50051135894793
Alternative ID
FF-400-07



3M™ Scott™ ELSA Emergency Escape Breathing Device

3M Stock
B5005270001

3M™ Replacement Filter Kit 523-01-29 1 EA/Case

3M Stock
7000056891
Previous 3M Stock
78812400105
UPC
00051138720100
Alternative ID
-502909



3M™ Versaflo™ Filter Cover TR-6700FC/37356(AAD), for TR-6710N Filter, 1 EA/Case

3M Stock
7100021251
Previous 3M Stock
70071618261
Alternative ID
TR-6700FC



3M™ Adflo™ Filter Cover 35-1099-81

3M Stock
7100200482
UPC
00076308943691
Alternative ID
35-1099-81



3M™ Versaflo™ TR-300+ Series PAPR Filter Cover TR-371+ 1 EA/Case

3M Stock
7100156020
UPC
00051131277045
Alternative ID
TR-371+



3M™ Versaflo™ Breathing Tube Radiant Heat Cover BT-927N, 1 EA/Case

3M Stock
7100154106
UPC
00076308942762
Alternative ID
BT-927N



3M™ Versaflo™ Breathing Tube Cover BT-922/W-3228-10 /37311(AAD), 10 EA/Case

3M Stock
7100077588
Previous 3M Stock
78806025280
UPC
00051131373112
Alternative ID
BT-922/W-3228-10



3M™ Manifold W-3079 1 EA/Case

3M Stock
7010319417
UPC
00051138293680
Alternative ID
W-3079



3M™ Air Deflector W-2924 1 EA/Case

3M Stock
7010348307
Previous 3M Stock
78806987554
UPC
00051138159054
Alternative ID
W-2924

3M™ Versaflo™ Replacement Airflow Deflector M-316, for M-300 and M-400 Series Hard Hats and Helmets, 1 EA/Case

3M Stock
7000127678
Previous 3M Stock
70071562014
UPC
00051131173187
Alternative ID
M-316

3M™ Versaflo™ Replacement Airflow Deflector M-116, for M-100 Face Shields, 1 EA/Case

3M Stock
7000127600
Previous 3M Stock
70071544947
UPC
00051131173132
Alternative ID
M-116



3M™ Vortex Holder Kit W-3016 1 EA/Case

3M Stock
7000130753
Previous 3M Stock
78802945689
UPC
00051138164126
Alternative ID
W-3016

3M™ Vortemp™ Holder Kit W-3017 1 EA/Case

3M Stock
7000130754
Previous 3M Stock
78802945796
UPC
00051138164157
Alternative ID
W-3017

3M™ Combination Dual Airline Front-Mounted Breathing Tube SA-1600, 1 Ea/Case

3M Stock
7000002043
Previous 3M Stock
70070710085
Alternative ID
SA-1600



3M™ Combination Dual Airline
Back-Mounted Breathing Tube
SA-2600/37001(AAD) 1
EA/Case

3M Stock
7000002044
Previous 3M Stock
70070710119
Alternative ID
SA-2600

3M™ SecureFit™ Vented Hard
Hat CHH-V-R-W6-SL, With
Ratchet Adjustment, 6/case

3M Stock
V101514142
UPC
00051131226708

3M™ Outdoor Safety Eyewear,
90954-BU10-NA, Gray
Frame/Gray Scratch Resistant
Lens, 10/cs

3M Stock
70006947405
UPC
00078371113278



3M™ Safety Eyewear Anti-
Scratch, 90954H1-DC-20, Gray,
Gray Lens, 20/case

3M Stock
70006987971
UPC
00051141332192



3M™ Safety Eyewear 90954H4-
DC, Gray, Gray Lens, Anti-
Scratch, 4/pack, 10 packs/case

3M Stock
70006997020
UPC
00076308723934

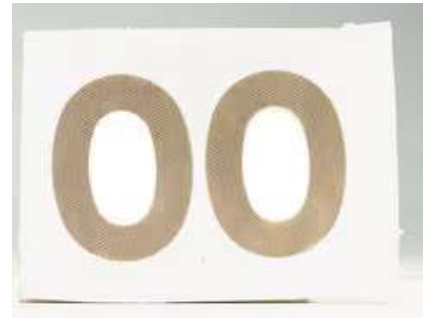

3M™ PELTOR™ Hygiene
Cleaning Pads, 100 Pads / Pack,
HY100A

3M Stock
7100064410
Previous 3M Stock
XH001651351
UPC
07318640048362
Alternative ID
HY100A



3M™ Aura™ Particulate Respirators 9200+ Series



3M™ P100 Particulate Filters 2097H2-DC, 2 pair/pack, 5 packs/case

3M Stock
70006994852
UPC
00051141928579



3M™ PELTOR™ X1/X2 Earmuff Probed Test Cushions 393-3001-2, 2 EA/Case

3M Stock
7100062126
Previous 3M Stock
70071691110
UPC
00078371668341
Alternative ID
393-3001-2



3M™ E-A-R™ Skull Screws™ Earplugs



3M™ Cartridge Washer W-2923 1 EA/Case

3M Stock
7010318167
Previous 3M Stock
78800862324
UPC
00051138155605
Alternative ID
W-2923



3M™ Hatshell W-3258-5/07039(AAD) 5 Hatshells/Case

3M Stock
7000131000
Previous 3M Stock
78806027765
UPC
50051131070399
Alternative ID
W-3258-5



3M™ Versaflo™ Air Duct Sealing Ring for Premium Head Suspension S-956, 5 EA/Case

3M Stock
7000127440
UPC
00051131373082
Alternative ID
S-956



3M™ Hard Hat Front Visor Seal GR2B-10P 10 EA/Case

3M Stock
7000103819
Previous 3M Stock
XA007704209
UPC
10093045936271
Alternative ID
GR2B-10P



3M™ E-A-Rsoft™ Grippers™ Earplugs 312-6001, Corded, 2000 Pair/Case

3M Stock
7000127654
Previous 3M Stock
70071559739
UPC
10080529120905
Alternative ID
312-6001



3M™ Self-Retracting Lifeline Fast Line Drum Lock Tool 9600037

3M Stock
7100311233
Previous 3M Stock
9600037
Alternative ID
9600037



3M™ PELTOR™ X5 Earmuffs



3M™ Versaflo™ Air-Flow Adjustment Cover for Premium Head Suspension, S-955, 1 EA/Case

3M Stock
7100010623
Previous 3M Stock
70071533445
Alternative ID
S-955



**3M™ Hood Insert RBE-FIH 1
EA/Case**

3M Stock
7010341609

Previous 3M Stock
70071405750

UPC
00051131989290

Alternative ID
RBE-FIH



**3M™ H-700 Series Hard Hat
Systems**

3M Stock
B10434507



**3M™ DBI-SALA® SSB Cable
Climb Assist System
Counterweight 3511598,
Galvanized Steel, 80 lb**

3M Stock
7100268945

UPC
00840779002245

Alternative ID
3511598



**3M™ DBI-SALA® Confined
Space Top Pulley Assembly For
UCT Tripod 8512293**

3M Stock
7100260273

UPC
00840779008766

Alternative ID
8512293



**3M™ DBI-SALA® Confined
Space Davit Quick Release
Mounting Bracket 8516824**

3M Stock
7100204306

UPC
00840779005796

Alternative ID
8516824



**3M™ DBI-SALA®
SecuraSpan™ Fasten-in-Place
HLL Weld-on Vertical Base
7400222, 1 ea**

3M Stock
7100220297

UPC
00840779013135

Alternative ID
7400222



3M™ DBI-SALA® Rollgliss™ Sloped Low Speed Automatic Descender Hardware Kit 3302981, Stainless Steel Hook

3M Stock
7012818834
Alternative ID
3302981



3M™ DBI-SALA® Sealed-Blok™ 3-Way Retrieval Self-Retracting Lifeline Mounting Bracket 3401025

3M Stock
7100260274
UPC
00840779050208
Alternative ID
3401025



3M™ DBI-SALA® Wood Pole Fall Restricting Device



3M™ PROTECTA® Compliance in a Can™ Light Roofer's Fall Protection Kit

3M Stock
B00035927



3M™ Protecta® Self-Retracting Lifeline Cover 3590012, Fits 66 - 100 ft Standard and 50 - 66 ft Leading Edge Models

3M Stock
7100263466
Previous 3M Stock
3590012
UPC
00840779141388
Alternative ID
3590012



3M™ DBI-SALA® Synthetic Horizontal Lifeline System



3M™ Protecta® Equipment Carrying and Storage Bag AK061A, 10 in x 10 in x 18 in

3M Stock
7012822283
Previous 3M Stock
AK061A
UPC
00648250110607
Alternative ID
AK061A



3M™ Dual Airline Back-Mounted Breathing Tube SA-2500/07148(AAD), 1 EA/Case

3M Stock
7000002006
Previous 3M Stock
70070613214
Alternative ID
SA-2500

3M™ Dual Airline Front-Mounted Breathing Tube SA-1500/07147(AAD) 1 EA/Case

3M Stock
7000002003
Previous 3M Stock
70070611655
Alternative ID
SA-1500



3M™ DBI-SALA® Ultra-Lok™ Self-Retracting Lifeline



3M™ DBI-SALA® Carabiner



3M™ DBI-SALA® Confined Space Integrated Barrel Mount Sleeve Davit Mast Base 8510323, Zinc Plated Steel

3M Stock
7100260032
UPC
00840779005994
Alternative ID
8510323



3M™ OX™ Safety Glasses



3M™ Solus™ 1000 Series Safety Glasses



3M™ DBI-SALA® Rescue Pole
8900299, Black, 1 EA

3M Stock
7100214233

UPC
00840779141319

Alternative ID
8900299



3M™ Protective Coverall 4570



3M™ PELTOR™ Camelback
Gel Sealing Rings HY80, 1 pr/cs

3M Stock
7000127268

Previous 3M Stock
70071524139

UPC
00093045979493

Alternative ID
HY80



3M™ PELTOR™ Gel Ear
Cushions for Peltor Headsets
HY80A, U.S. Made, 1 EA/Case

3M Stock
7100014310

Previous 3M Stock
70071573656

UPC
00093045934676

Alternative ID
HY80A



**3M™ PELTOR™ Skull Screw
Communication Tip
Replacements, 10 EA/Case**

3M Stock
7000128201
Previous 3M Stock
70071615275
UPC
10093045936455
Alternative ID
370-1019-10



**3M™ PELTOR™ Right Side
Boom Mounting Y-Harness
FL6AB, 1 EA/Case**

3M Stock
7000107801
Previous 3M Stock
XH001651989
UPC
07318640027589
Alternative ID
FL6AB



**3M™ PELTOR™ Cell Phone
Patch Cord FL6CS 1 EA/Case**

3M Stock
7000107804
Previous 3M Stock
XH001652052
UPC
07318640042759
Alternative ID
FL6CS



**3M™ PELTOR™ Hygiene Tape
for Microphone, HYM1000, 4.5
M, 96 ea/Case**

3M Stock
7100064281
Previous 3M Stock
XH001651328



3M™ PELTOR™ FLX2 Cables



**3M™ DBI-SALA® Remote
Anchoring System**



3M™ Speedglas™ Welding
Helmet Battery
04-0320-00/37137(AAD), 1

EA/Case
3M Stock
B00039813
UPC
50051131371373



3M™ PELTOR™ ProTac III
MT13H221P3E, Headset, Black,
Helmet Attached, 10 Each/Case

3M Stock
7100088423
Previous 3M Stock
UU004690614
UPC
04054596123250
Alternative ID
MT13H221P3E



3M™ PELTOR™ ProTac III
MT13H220P3E, Slim Headset,
Black, Helmet Attached, 10
Each/Case

3M Stock
7100088455
UPC
04054596123199
Alternative ID
MT13H220P3E



3M™ PELTOR™ ProTac III
MT13H220A, Slim Headset,
Black, Headband, 10 Each/Case

3M Stock
7100088456
UPC
04054596123106
Alternative ID
MT13H220A



3M™ Welding Protective
Covers, Hoods, & Shrouds



3M™ Speedglas™ Welding
Starter Kit 9100XX 06-0202-30,
for 9100MP, 1 EA/Case

3M Stock
7010384807
UPC
00051141562032
Alternative ID
06-0202-30



**3M™ Speedglas™ Welding
Starter Kit 9100X 06-0202-20,
for 9100MP, 1 EA/Case**

3M Stock
7010341131

UPC
00051141562025

Alternative ID
06-0202-20



**3M™ Speedglas™ Welding
Starter Kit 9100V 06-0202-10,
for 9100MP, 1 EA/Case**

3M Stock
7010384806

UPC
00051141562018

Alternative ID
06-0202-10

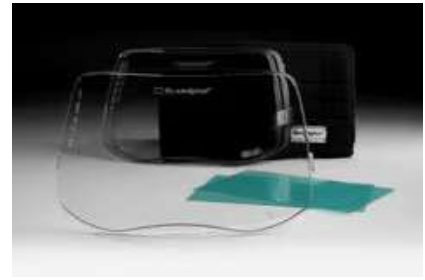

**3M™ Speedglas™ Welding
Starter Kit 9100XX 06-0201-30,
1 EA/Case**

3M Stock
7010315299

UPC
00051141562001

Alternative ID
06-0201-30

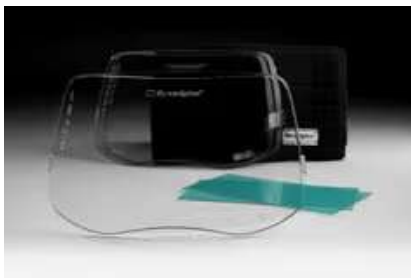

**3M™ Speedglas™ Welding
Starter Kit 9100X 06-0201-20, 1
EA/Case**

3M Stock
7010384805

UPC
00051141561998

Alternative ID
06-0201-20



**3M™ Secure Click™ Inhale &
Exhale Valve, HF-800-02, 10
EA/Bag**

3M Stock
7100181933

UPC
04054596621992

Alternative ID
HF-800-02



**3M™ Breathing Room Assembly
7916-5, Replacement Part 5
EA/Case**

3M Stock
7000126023

Previous 3M Stock
70070314284

UPC
50051138215632

Alternative ID
7916-5



**3M™ Lens Frame Assembly
FF-400-05, 5 EA/Case**

3M Stock
7000052736
Previous 3M Stock
70071516887
UPC
50051135894779
Alternative ID
FF-400-05



**3M™ Secure Click™ Lens
Frame Assembly FF-800-02, 5
ea/Case**

3M Stock
7100266242
Previous 3M Stock
70071765609
UPC
00638060432143
Alternative ID
FF-800-02



**3M™ Lens Frame Kit 7885,
Replacement Part 5 EA/Case**

3M Stock
7000125978
Previous 3M Stock
70070079101
UPC
50021200603346
Alternative ID
7885



**3M™ Full Facepiece Respirator
Packout 07163, Organic
Vapor/P95, Large**

3M Stock
7000126282
UPC
00051131071636
Alternative ID
07163



**3M™ Full Facepiece Respirator
Packout 07162, Organic
Vapor/P95, Medium**

3M Stock
7010315862
Previous 3M Stock
70070799443
UPC
00051131071629
Alternative ID
07162



**3M™ Speedglas™ G5-01
Welding Helmet Powered Air
System**



3M™ Scotchlite™ Reflective Material 8906 Series



3M™ Scott™ Air-Pak™ X3 SCBA

3M Stock
B5005047166



3M™ Scott™ Ska-Pak Supplied-Air Respirator

3M Stock
B5005047150



3M™ DBI-SALA® SSB Cable Climb Assist System Mounting Bracket 3511785, Fits Round Rung 3/4 - 1-1/2 in, Square Rung 9/16 - ...

3M Stock
7100268006

UPC
00840779002269

Alternative ID
3511785



3M™ DBI-SALA® SSB Cable Climb Assist System Mounting Bracket 3511783, Fits Round Rung to 3/4 in, Square Rung to 9/16 in

3M Stock
7100268946

UPC
00840779002252

Alternative ID
3511783



3M™ Breathe Easy™ PAPR Cartridges



3M™ Versaflo™ Respiratory Systems Carry Bag, 1/case

3M Stock
7100061107
Previous 3M Stock
70071673381
Alternative ID
TR-991

3M™ Carbon Monoxide Sensor 529-05-22, 1 EA/Case

3M Stock
7000131709
Previous 3M Stock
78812400188
UPC
00051138720186
Alternative ID
-500604

3M™ Nut Base W-2920, 1 EA/Case

3M Stock
7100063933
Previous 3M Stock
78800861631
UPC
00051138155254
Alternative ID
W-2920



3M™ DBI-SALA® Center Mount Sleeve Davit Base

3M™ Particulate Respirators 8000 Cup Series

3M™ PELTOR™ X3 Earmuffs X3B, Behind-the-Head, 10 EA/Case

3M Stock
7100123158
Previous 3M Stock
UU008197822
UPC
10078371671256
Alternative ID
X3B



3M™ Versaflo™ High Durability Hood with Integrated Head Suspension S-533S, Small/Medium, 1 EA/Case

3M Stock
7000127432
Previous 3M Stock
70071533239
UPC
00051131170896
Alternative ID
S-533S



3M™ Elevated Temperature Cotton + Para-aramide Front Helmet Cover, FC1-GR, Gray, 60 EA/Case

3M Stock
7100082485
Previous 3M Stock
UU003718515
UPC
04054596088269
Alternative ID
FC1-GR



3M™ Clear Acetate Faceshield V2A-10P 10 EA/Case

3M Stock
7000103810
Previous 3M Stock
XA007704118
UPC
10093045936189
Alternative ID
V2A-10P



3M™ Green Polycarbonate Faceshield V2B-10P 10 EA/Case

3M Stock
7000103811
Previous 3M Stock
XA007704126
UPC
10093045936196
Alternative ID
V2B-10P



3M™ DBI-SALA® Vaccum Anchor Lifeline System Fill Station 2200086

3M Stock
7100227209
UPC
00840779000944
Alternative ID
2200086



3M™ DBI-SALA® Lad-Saf™ Vertical Safety System Stand-Off Bracket 6100710, Stainless Steel

3M Stock
7012819734
Previous 3M Stock
6100710
Alternative ID
6100710



3M™ DBI-SALA® Positioning and Restraint Lanyard



3M™ Protecta® Confined Space Winch



3M™ Safety and Inspection Manager Software, Pro Additional Domain

3M Stock
6100003507

Previous 3M Stock
70999987269

Alternative ID
SIM-DOM-PRO



3M™ Safety and Inspection Manager Software, Analytics License

3M Stock
6100002302

Previous 3M Stock
70999986956

Alternative ID
SIM-ANYL



3M™ Safety and Inspection Manager, Classic

3M Stock
6010002885

Previous 3M Stock
70999986865

Alternative ID
SIM-CLASSIC



3M™ Safety and Inspection Manager, Pro

3M Stock
6010004158

Previous 3M Stock
70999986899

Alternative ID
SIM-PRO



**3M™ Safety & Inspection
Manager-Basic Unlimited Fall
Protection, US, 1000**

3M Stock
70999987236
Alternative ID
SIM-BASIC

**3M™ Health, Safety and
Compliance Software
Implementation, Classic**

3M Stock
70999987244
Alternative ID
SIM-TRN-CLASSIC

**3M™ Safety & Inspection
Manager, Classic Domain**

3M Stock
6100002210
Previous 3M Stock
70999986949
Alternative ID
SIM-DOM



**3M™ Safety & Inspection
Manager Software, Custom
Package**

3M Stock
70999987129
Alternative ID
SIM-ANYL

**3M™ Safety and Inspection
Manager, Pro Domain**

3M Stock
70999987269
Alternative ID
SIM-DOM

**3M™ Health, Safety and
Compliance Software
Implementation, Pro**

3M Stock
70999987251
Alternative ID
SIM-TRN-CLASSIC



**3M™ Adflo™ Particulate, Gas, &
Odor Filters**



3M™ Custom Fit Eyewear,
47311H1-DC, Black/Gray, Gray
Lens, 4/case

3M Stock
70009110431
UPC
00638060279632



3M™ Eyeglass Protectors,
47030H1-DC, Clear, Clear Lens,
Anti-Scratch, 6/case

3M Stock
70009101091
UPC
00051141390697



3M™ Custom Fit Eyewear,
47310H1-VDC, Black/Gray,
Clear Lens, 4/case

3M Stock
70009110332
UPC
00638060279618



3M™ SecureFit™ 400 Series
Safety Glasses



3M™ Eargage, Ear Measure
85099-00000, 50 EA/Case

3M Stock
7100141833
Previous 3M Stock
70071612082
UPC
10078371850996
Alternative ID
85099-00000



**3M™ PELTOR™ Hygiene Kit
HY45, 10 pair/Case**

3M Stock
7100107408

UPC
07318640067295

Alternative ID
HY45



**3M™ Speedglas™ Fresh-Air III
V-100 Vortex Air-Cooling Valve
Supplied Air System with 3M™
Speedglas™ 9100 MP Welding
Helmet**



**3M™ DBI-SALA® Sliding Beam
Anchor**



**3M™ DBI-SALA® Fixed Beam
Anchor 2108410, Fits 12 - 36 in
Wide, 2.5 in Thick**

3M Stock
7100260183

Previous 3M Stock
2108410

UPC
00840779000715

Alternative ID
2108410



**3M™ DBI-SALA® Fixed Beam
Anchor 2108408, Fits 2.5 - 24 in
Wide, 1.5 in Thick**

3M Stock
7100241958

UPC
00840779000708

Alternative ID
2108408



**3M™ DBI-SALA® Fixed Beam
Anchor 2108407, 1 EA**

3M Stock
7100207456

Previous 3M Stock
2108407

UPC
00840779000692

Alternative ID
2108407



3M™ DBI-SALA® Cable Tie-Off Adaptor



3M™ Speedglas™ Welding Helmet SL, Welding Safety 05-0013-00 1 EA/Case

3M Stock
7010384820

UPC
00051141562568

Alternative ID
05-0013-00



3M™ Adflo™ Powered Air Purifying Respirator HE System w 3M™ Speedglas™ Welding Helmet 9100 FX-Air, 36-1101-30iSW, 1 EA/CASE

3M Stock
B00040334

UPC
00076308943820



3M™ Speedglas™ Pivot Kit 27-0099-52, for 9100MP Welding Helmets, 1 EA/Case

3M Stock
7000128223

Previous 3M Stock
70071621588

UPC
00051141558127

Alternative ID
27-0099-52



3M™ Versaflo™ M-Series Helmet Welding Knob and Pivot Kit M-146SG, 1 EA/Case

3M Stock
7100168648

UPC
00076308942779

Alternative ID
M-146SG



3M™ Speedglas™ G5-02 Headband Pivot Mechanism 08-0400-52, Left and Right Side, 1 ea

3M Stock
7100239940

Previous 3M Stock
70071736071

UPC
00076308944407

Alternative ID
08-0400-52



3M™ Speedglas™ Pivot Cover Plate Kit 06-0116-00QR, 1 EA/Case

3M Stock
7100031973

UPC
00051141563695

Alternative ID
06-0116-00QR



3M™ Speedglas™ 9100 Welding Headband 06-0400-52-B, Left and Right Side Pivot Mechanism, 5 EA/Case

3M Stock
7000127154

Previous 3M Stock
70071510575

UPC
50051135893987

Alternative ID
06-0400-52-B



3M™ Adflo™ Leather Belt Front Replacement 15-0099-06, 1 EA/Case

3M Stock
7000126725

Previous 3M Stock
70071268414

UPC
00051131925908

Alternative ID
15-0099-06



3M™ Adapter 529-04-50, 110-120 VAC, 1 EA/Case

3M Stock
7000131705

Previous 3M Stock
78812400139

UPC
00051138720131

Alternative ID
529-04-50

3M™ Adapter H-120 4/case

3M Stock
7000127718

Previous 3M Stock
70071563772

UPC
00051131173828

Alternative ID
H-120

3M™ Bowl Gasket W-2921, 1 EA/Case

3M Stock
7000130674

Previous 3M Stock
78800862167

UPC
00051138155520

Alternative ID
W-2921



**3M™ Versaflo™ Replacement
Jaw Gasket M-441, for M-400
Helmets, 1 EA/Case**

3M Stock
7000127682
Previous 3M Stock
70071562071
Alternative ID
M-441



**3M™ Versaflo™ Replacement
Visor Gasket
M-921/37321(AAD), 5 EA/Case**

3M Stock
7000127688
Previous 3M Stock
70071562154
UPC
00051131373211
Alternative ID
M-921



**3M™ TR-654 Replacement
Gaskets for TR-653 Cleaning
and Storage Kit, 20/Bag, 4 Bags
EA/Case**

3M Stock
7100134768
Previous 3M Stock
70071651684
UPC
00051131373846



**3M™ Adflo™ Rubber Breathing
Tube Foam Gasket 15-0099-11,
1 EA/Case**

3M Stock
7100077599
Previous 3M Stock
70071275013
UPC
00051131932524
Alternative ID
15-0099-11



**3M™ Gasket 061-35-04R01 1
EA/Case**

3M Stock
7000126354
Previous 3M Stock
70070885655
UPC
00051138722616
Alternative ID
061-35-04R01



**3M™ Air Deflector Gasket
W-2925, 1 EA/Case**

3M Stock
7100061977
Previous 3M Stock
78801431848
UPC
00051138159061
Alternative ID
W-2925



3M™ Welding Battery Chargers



3M™ Tri-Flange™ Earplugs



3M™ E-A-R™ E-Z-Fit™
Earplugs 312-1222, Corded,
Poly Bag, 2000 Pair/Case

3M Stock
7000127211

Previous 3M Stock
70071520871

UPC
10080529120165

Alternative ID
312-1222



3M™ E-A-R™ E-Z-Fit™
Earplugs 312-1208, Uncorded,
PolyBag, 2000 Pair/Case

3M Stock
7100007118

Previous 3M Stock
70071515210

UPC
10080529120073

Alternative ID
312-1208



3M™ PELTOR™ X4 Earmuffs



3M™ E-A-RTEMP™ 13A Foam
Temporary Earmold beige foam
eartip with pre-bent tube
420-2060, 25 EA/Case

3M Stock
7010342198

Previous 3M Stock
70071615952

UPC
10080529510072

Alternative ID
420-2060



**3M™ DBI-SALA® Flexiguard™
Freestanding Ladder Adjustable
Height Access Anchor System
8567719, 2 User, 18.5 – 31 ft.**

3M Stock
7012755908
Previous 3M Stock
8567719
Alternative ID
8517719

**3M™ DBI-SALA® Flexiguard™
Freestanding Ladder Adjustable
Height Access Anchor System
8567717, 2 User, 14.5 - 23 ft**

3M Stock
7012755906
Alternative ID
8517717

**3M™ V4 Series Faceshields &
Visors**



**3M™ DBI-SALA® Cable
Horizontal Lifeline System**



**3M™ DBI-SALA® Adjustable
Web Positioning Lanyard
1231016, 6 ft**

3M Stock
7100241701
UPC
00648250161685
Alternative ID
1231016



**3M™ DBI-SALA® Adjustable
Web Positioning Lanyard
1231012, 4 ft**

3M Stock
7012816998
UPC
00840779040421
Alternative ID
1231012



**3M™ DBI-SALA® Adjustable
Rope Positioning Lanyard**
1232210, 1/2 in Polyester, 6 ft
3M Stock
7012817068
UPC
00840779010806
Alternative ID
1232210



**3M™ DBI-SALA® Rollgliss™
R550 Rescue and Descent
Device Humidity Case 9508289,
Up To 500 ft**
3M Stock
7100246539
UPC
00840779108084
Alternative ID
9508289



**3M™ DBI-SALA® Confined
Space Tripod**



3M™ E-A-Rsoft™ FX Earplugs



**3M™ PELTOR™ WorkTunes™
Pro AM/FM Radio Headset,
Black, Hard Hat Attached**

3M Stock
7100089369
Previous 3M Stock
UU004690689
UPC
00078371670887
Alternative ID
HRXS221P3E-NA



**3M™ PELTOR™ WorkTunes™
Pro AM/FM Radio Headset,
Black, Headband**

3M Stock
7100089367
Previous 3M Stock
UU004690671
UPC
00078371670863
Alternative ID
HRXS221A-NA



3M™ Overshoe 442

3M Stock
B00014983



3M™ Scotchlite™ Reflective
Material 8910 Series



3M™ DBI-SALA® Roof Top
Freestanding Counterweight
Anchor 2100185, 1 EA

3M Stock
7100218795
UPC
00648250173275
Alternative ID
2100185



3M™ DBI-SALA® Personal Self-
Rescue Training Kit 3320053, 50
ft, Rope

3M Stock
B00024172
UPC
00648250244593



3M™ DBI-SALA® Confined
Space Tripod Pulley



3M™ E-A-R™ Classic Regular
Earplugs



3M™ Comfort Grip Gloves - Cut-
Resistant



3M™ PELTOR™ ALERT™
M2RX7P3E2-01, FM-Radio,
Level Dependent Headset
Helmet Attached, 10 Each/Case

3M Stock
7000108538

UPC
07318640063266

Alternative ID
M2RX7P3E2-01



3M™ PELTOR™ ALERT™
M2RX7A2-01, FM-Radio, Level
Dependent Headset Headband,
10 Each/Case

3M Stock
7000108376

UPC
07318640055421

Alternative ID
M2RX7A2-01



3M™ Scotchlite™ Reflective
Material 9910 Series



3M™ DBI-SALA® Single
Counterweight Plate For Roof
Top Anchor 7200439, 45 lb

3M Stock
7100311195

Previous 3M Stock
7200439

UPC
00840779003044

Alternative ID
7200439



3M™ DBI-SALA® Self-Rescue



3M™ DBI-SALA® Confined Space UCT Tripod System



3M™ PELTOR™ Replacement Earplug TEP-300L TN, Left, Tan, 20 ea/Case

3M Stock
7100227647

Previous 3M Stock
70071734399

UPC
00638060429945

Alternative ID
TEP-300L TN



3M™ PELTOR™ Replacement Earplug TEP-300R GE, Right, Gray, 20 ea/Case

3M Stock
7100227648

Previous 3M Stock
70071734381

UPC
00638060429969

Alternative ID
TEP-300R GE



3M™ PELTOR™ Black TEP-200 Replacement Earbud

3M Stock
7100141747

Previous 3M Stock
70071677051

UPC
00093045938308

Alternative ID
TEP-200E



3M™ PELTOR™ Replacement Earplug TEP-300L GE, Left, Gray, 20 ea/Case

3M Stock
7100227645

Previous 3M Stock
70071734373

UPC
00638060429976

Alternative ID
TEP-300L GE



3M™ PELTOR™ Yellow LEP-200 Replacement Earbud

3M Stock
7100141802

Previous 3M Stock
70071677044

UPC
00093045938292

Alternative ID
LEP-200E



**3M™ PELTOR™ TEP-100E
Tactical Earplug Replacement
Earpiece, 1 EA/Case**

3M Stock
7100066369
Previous 3M Stock
70071650256
UPC
00078371665234
Alternative ID
TEP-100E



**3M™ PELTOR™ Replacement
Earplug TEP-300L CY, Left,
Coyote Brown, 20 ea/Case**

3M Stock
7100227644
Previous 3M Stock
70071734415
UPC
00638060429907
Alternative ID
TEP-300L CY



**3M™ PELTOR™ Replacement
Earplug TEP-300R TN, Right,
Tan, 20 ea/Case**

3M Stock
7100227649
Previous 3M Stock
70071734407
UPC
00638060429914
Alternative ID
TEP-300R TN



**3M™ PELTOR™ TEP-100C,
Tactical Earplug Replacement
Charging Case, 1 ea/Case**

3M Stock
7100066370
Previous 3M Stock
70071650264
UPC
00078371665241
Alternative ID
TEP-100C



**3M™ PELTOR™ Replacement
Earplug TEP-300R CY, Right,
Coyote Brown, 20 ea/Case**

3M Stock
7100227632
Previous 3M Stock
70071734332
UPC
00638060429891
Alternative ID
TEP-300R CY



**3M™ PELTOR™ Flex Cable for
MOTOTRBO, FL6U-63, 1
EA/Case**

3M Stock
7000108535
Previous 3M Stock
XH001680350
UPC
07318640063235
Alternative ID
FL6U-63



3M™ PELTOR™ External Radio Patch Cord FL6BR, 1 EA/Case

3M Stock
7100016085

Previous 3M Stock
XH001652029

UPC
07318640045859

Alternative ID
FL6BR



3M™ PELTOR™ G79 Series Motorsport Communication Adaptor Cable FL6U-21, -77 Flex Motorola GP300, CP040 1 EA/Case

3M Stock
7100064359

Previous 3M Stock
XH001654850

UPC
07318640039933

Alternative ID
FL6U-21



3M™ PELTOR™ G79 Series Motorsport Communication Adaptor Cable FL6U-28, -77 Flex 2.5 mm stereo, 1 ea/cs

3M Stock
7100064305

Previous 3M Stock
XH001654868

UPC
07318640039445

Alternative ID
FL6U-28



3M™ PELTOR™ G79 Series Motorsport Communication Adaptor Cable FL6U-32, -77Flex Motorola GP340/328 1 EA/Case

3M Stock
7100064602

Previous 3M Stock
XH001654900

UPC
07318640040069

Alternative ID
FL6U-32



3M™ SecureFit™ 600 Series Safety Glasses



3M™ E-A-Rsoft™ Yellow Neons™ Earplugs



**3M™ Peltor™ E-A-R buds™
Corded Earplugs 2600,
Replacement Tips 3 EA/Bag**

3M Stock
7000127615
Previous 3M Stock
70071558137
UPC
10080529190540
Alternative ID
EARbudtips



**3M™ PELTOR™ Headset
Carrying Drawstring Bag, Coyote
Brown, FP9007-Draw, 1
EA/Case**

3M Stock
7010384657
Previous 3M Stock
70071613205
UPC
00093045935109
Alternative ID
FP9007-DRAW



**3M™ PELTOR™ SoundTrap™
Slimline Earmuff MT15H67FB,
Tactical Electronic Headset
Headband, 1 EA**

3M Stock
7100009538
Previous 3M Stock
70071524147
UPC
07318640002401
Alternative ID
MT15H67FB



**3M™ Sanding Respirator,
03201, 2 per pack, 12 packs per
case**

3M Stock
B40068078
UPC
00051131335011



**3M™ Scotchlite™ Reflective
Material C925 Series**



**3M™ Scotchlite™ Reflective
Material 8912 Series**



3M™ Performance Particulate Respirator 8210Plus

3M Stock
CBGNAWUS1818
UPC
00638060137284



FUTURO™ Performance Compression Calf Sleeve

3M Stock
CBGBLRUS1490
UPC
00051131204959



3M™ SecureFit™ 400 Safety Eyewear SF400G-LV-4-PS, Gray Anti-Fog, 1 Eyewear, 4/case

3M Stock
CBGNARUS2574
UPC
00076308913564



Peltor™ Sport Ultimate Hearing Protector

3M Stock
CBGNARUS2508
UPC
00051125005661



3M™ Hi-Viz Vest, Class 3, Short Sleeve, 94900-80030, Yellow, 5/case

3M Stock
CBGNAWUS2198
UPC
00051141401867



90537-80025T 3M(TM) Tekk Protection(TM) Band Style Hearing Protector, 6/case

3M Stock
CBGNAW011146
UPC
10078371613171



FUTURO™ Pantyhose for Women

3M Stock
CBGBLW011020

UPC
00051131215825



3M™ Speedglas™ G5-03 Head Cover Holder 46-0700-00

3M Stock
7100319677

Previous 3M Stock
70100400715

UPC
00638060431221

Alternative ID
46-0700-00



3M™ S-Series PAPP Headcovers & Headcover Assemblies



3M™ DBI-SALA® EZ-Stop™ Arc Flash 100% Tie-Off Web Loop Stretch Web Shock-Absorbing Lanyard 1246532, Kevlar® Fiber, 6 ft

3M Stock
7012817325

Alternative ID
1246532



3M™ Scott™ ELSA Emergency Escape Breathing Device Carry Bag-N

3M Stock
B5005297015



3M™ Solus™ 2000 Series, S2025AF-BLU, Blue/Gray Temples, Clear Reader +2.5 Anti-Fog/Anti-Scratch lens, 20 ea/Case

3M Stock
7100222135

UPC
50638060429209

Alternative ID
S2025AF-BLU



3M™ Solus™ 2000 Series,
S2020AF-BLU, Blue/Gray
Temples, Clear Reader +2.0
Anti-Fog/Anti-Scratch lens, 20
ea/Case

3M Stock
7100222269

UPC
50638060429193

Alternative ID
S2020AF-BLU



3M™ Solus™ 2000 Series,
S2015AF-BLU, Blue/Gray
Temples, Clear Reader + 1.5
Anti-Fog/Anti-Scratch Lens, 20
ea/Case

3M Stock
7100221704

UPC
50638060429186

Alternative ID
S2015AF-BLU



3M™ E-A-Rsoft™ SuperFit™
Earplugs 311-4109, Metal
Detectable, 2000 Pair/Case

3M Stock
7010384671

Previous 3M Stock
70071614245

UPC
10080529191035

Alternative ID
311-4109



3M™ TEKK Protection™
SecureFit™ Safety Eyewear
SF201-PV6, Tinted/AF Lens

3M Stock
CBGNARUS2575

UPC
00051141388946



3M™ Professional Multi-Purpose
Respirator with Quick Latch
65023QLHA1C-PS, 1/pk, 4
pkcs/case

3M Stock
CBGNARUS1064

UPC
00076308726522



3M™ Performance Safety
Eyewear, Aerodynamic Design,
47090-WZ4, Black w/Red
Accent Frame, Clear Lens, Anti-
Fog

3M Stock
CBGNARUS2456

UPC
00076308725860



Peltor™ Sport RangeGuard™
Electronic Hearing Protector
3M Stock
CBGNAR2348
UPC
00051141990590



3M™ Hi-Viz Hard Hat Sun
Shade, 94800-80030, Yellow,
8/case
3M Stock
CBGNAWUS2199
UPC
00051141401898



94601-80030T 3M(TM) Tekk
Protection(TM) Reflective
Clothing Day/Night Safety Vest,
8/case
3M Stock
CBGNAW011190
UPC
10078371625570



91295-80025T 3M(TM) Tekk
Protection(TM) Hard Hat White
12/case
3M Stock
CBGNAW011168
UPC
10078371612297



3M™ Hard Hat with Ratchet
Adjustment Yellow
3M Stock
CBGNAW011147
UPC
10078371620100



3M™ 52P71 Disposable
Respirator Paint Project
3M Stock
CBGNAW011123
UPC
00051131918047



3M™ Worktunes™ AM/FM Hearing Protector, 90541H1-DC-PS, 4 eaches/case

3M Stock
CBGNAW011080
UPC
00078371905415



FUTURO™ Dress Socks for Men, Moderate Compression

3M Stock
CBGBLW011021
UPC
00051131215962



3M™ Secure Click™ Hard Case P100 Particulate Filter D9093CB, with Nuisance Level Acid Gas Relief, 144 ea/Case

3M Stock
7100206896
UPC
50689330191548
Alternative ID
D9093CB



3M™ Secure Click™ Hard Case P100 Particulate Filter D9093B, 144 ea/Case

3M Stock
7100206895
UPC
50689330191555
Alternative ID
D9093B



3M™ Secure Click™ Particulate Cartridge P95/Hydrogen Fluoride w/ Nuisance Acid Gas Relief D3076HF, 100 ea/Case

3M Stock
7100213424
UPC
50051131278122
Alternative ID
D3076HF



3M™ Secure Click™ Particulate Filter P95 with Nuisance Level Organic Vapor/Acid Gas Relief D3078, 100 ea/Case

3M Stock
7100213435
UPC
50051131278139
Alternative ID
D3078



**3M™ DBI-SALA® Flexiguard™
M100 Modular Jib Rescue
Mount and Pulley Kit 8530905,
Black**
3M Stock
7012820972
Previous 3M Stock
8530905
Alternative ID
8530905



**3M™ DBI-SALA® FlexiGuard™
M100 Semi-Fixed Height Mast**



**3M™ Exhalation Valve Filter
604, 30 ea/Case**
3M Stock
7100245392
UPC
50638060431950
Alternative ID
604



**3M™ Powerflow™ PAPR
Systems**



**ACE™ Brand Sports
Compression Knee Sleeve**
3M Stock
CBGBLRUS1526
UPC
00051131194113



**FUTURO™ Performance
Compression Knee Sleeve**
3M Stock
CBGBLRUS1492
UPC
00051131204911



3M™ Paint Project Respirator with Quick Latch 6502QLPA1-A-PS, Size Medium, 1 Ea/Pk, 4 Pks/Cs

3M Stock
CBGNARUS1065
UPC
00076308729974



3M™ SecureFit™ 400 Eye Protection SF400C-WV-6-PS Clear Anti-Fog, 6ea/cs

3M Stock
CBGNARUS2460
UPC
00076308723941



Peltor™ Sport Tactical 100 Electronic Hearing Protector, TAC100-OTH, 4/CV

3M Stock
CBGNAR2349
UPC
00051141394237



3M™ Hi-Viz Construction Vest Orange

3M Stock
CBGNAW011211
UPC
00078371946258



3M™ Particulate Respirator 8200

3M Stock
CBGNAW011148
UPC
00051141904832



3M™ Full-Brim Non-Vented Hard Hat with Ratchet Adjustment, CHH-FB-R-W6-PS, 6/case

3M Stock
CBGNAW011127
UPC
00078371912802



3M™ Vented Pro Ratchet Hard Hat

3M Stock
CBGNAW011084

UPC
10078371625709



FUTURO™ Trouser Socks for Women, Moderate Compression

3M Stock
CBGBLW011022

UPC
00051131215924



3M™ Versaflo™ TR-600 Series PAPR Systems



3M™ PELTOR™ CH-3 Headset with PTT Neckband MT74H52B-111, FLX2, 10 ea/Case

3M Stock
7100205729

UPC
04054596695726

Alternative ID
MT74H52B-111



3M™ Speedglas™ G5-01 Outer Welding Visor Frame, 46-0700-63, 1 EA/Case

3M Stock
7100214395

UPC
00076308944636

Alternative ID
46-0700-63



3M™ E-A-R™ Classic™ Probed Test Plugs 393-2007-50, Small Size, 50 EA/Case

3M Stock
7000052884

Previous 3M Stock
70071562816

UPC
10080529190809

Alternative ID
393-2007-50



**3M™ E-A-R™ Classic™ Probed
Test Plugs 393-2003-50, 50
EA/Case**

3M Stock
7000052882
Previous 3M Stock
70071562774
UPC
10080529190762
Alternative ID
393-2003-50



**3M™ PELTOR™ ComTac™ VII
Headset**



**3M™ E-A-R™ E-A-R Caps™
Model 200 Hearing Protector
Replacement Pods 321-2103, 10
EA/Case**

3M Stock
7000127665
Previous 3M Stock
70071561321
UPC
10080529190663
Alternative ID
321-2103



**3M™ Speedglas™ G5 Scrape
Guard 46-0700-82, 3 EA/Case**

3M Stock
7100311871
Alternative ID
46-0700-82



**3M™ PELTOR™ Replacement
Clip PIC-100CL, 20 ea/Case**

3M Stock
7100262875
UPC
00638060433119
Alternative ID
PIC-100CL



**3M™ GoggleGear™ 6000
Series Safety Goggles**



**3M™ Scott™ Monitor Telemetry
Software Solution**

3M Stock
B5005270004



**3M™ DBI-SALA® FlexiGuard™
M200 Semi-Fixed Height Mast**



**3M™ Speedglas™ Air Duct
Tube 25-0400-55, 1 EA/Case**

3M Stock
7000128107
Previous 3M Stock
70071607686
UPC
00051131498358
Alternative ID
25-0400-55



**3M™ Speedglas™ Duct
Assembly 26-0400-55, 1
EA/Case**

3M Stock
7000128095
Previous 3M Stock
70071606837
UPC
00051131497245
Alternative ID
26-0400-55



**3M™ Scott™ Weld-O-Vista
Facepiece**

3M Stock
B5005047155



**3M™ Scott™ AV-3000 HT
Facepiece**

3M Stock
B5005218022



3M™ PELTOR™ Earmuff Hygiene Kit HY68, Green Earseals, 1 kt/cs

3M Stock
7000039647
Previous 3M Stock
XH001652482
UPC
07318640025615
Alternative ID
HY68 SV



3M™ PELTOR™ Hygiene Kit for Worktunes Headset HY220, 1 EA/Bag

3M Stock
7100101874
Previous 3M Stock
UU008049353
UPC
04054596206311



3M™ DBI-SALA® Metal Horizontal Lifeline Energy Absorber with Hardware Kit 7401031, 2 Shackles

3M Stock
7012820255
UPC
00840779003891
Alternative ID
7401031



3M™ DBI-SALA® Metal Horizontal Lifeline Energy Absorber with Hardware Kit 7401033, 3 Shackles, Turnbuckle, Cable Clips

3M Stock
7012798862
UPC
00648250163115
Alternative ID
7401033



3M™ DBI-SALA® Flexiguard™ Jib Counterweight Base Stabilizing Jack Kit 8530563, Yellow

3M Stock
7100231983
Previous 3M Stock
8530563
UPC
00840779106868
Alternative ID
8530563



3M™ Tie-Back Double Locking Snap Hook 9501804, Zinc Plated Steel, 5000 lb Gate, 0.82 in. Throat

3M Stock
7012821224
Previous 3M Stock
9501804
Alternative ID
9501804



**3M™ VersaFlo™ Vortex Spare
Parts Kit V-115 1 EA/Case**

3M Stock
7000126274
Previous 3M Stock
70070799047
UPC
00051138661618
Alternative ID
V-115



**3M™ Comfort Grip Gloves -
General Use**



**3M™ SecureFit™ 400 Eye
Protection SF400G-WV-6-PS,
Gray Anti-Fog, 6ea/cs**

3M Stock
CBGNARUS2461
UPC
00076308723989



**Peltor™ Sport Blasts™
Disposable Earplugs
97080-10C, 3 Pair Pack, Neon
Yellow**

3M Stock
CBGNAR2365
UPC
00078371970802



**FUTURO™ Ultra Sheer Knee
Highs for Women, Moderate
Compression**

3M Stock
CBGBLW011023
UPC
00051131215917



**3M™ DBI-SALA® Tagline
7211857**

3M Stock
7100227212
UPC
00840779081011
Alternative ID
7211857



**3M™ DBI-SALA® Rope Tagline
7211856, 3/16 in Polypropylene,
50 ft**

3M Stock
7100314305
UPC
00840779081004
Alternative ID
7211856



**3M™ DBI-SALA® Nano-Lok™
edge Self-Retracting Lifeline
Pack Adaptor For Harness
3100184**

3M Stock
7012818432
Previous 3M Stock
3100184
UPC
00840779139828
Alternative ID
3100184



**3M™ Versaflo™ Mining Lamp
Bracket Kit M-940, for M-Series
Hard Hats and Helmets, 1
ea/Case**

3M Stock
7100265324
UPC
50638060433510
Alternative ID
M-940



**3M™ Dual Cartridge Respirator
Packout 07179, Organic
Vapor/P95, Large**

3M Stock
7010339796
UPC
00051131071797
Alternative ID
07179



**3M™ SecureFit™ Full Brim Hard
Hat CHH-FB-R-O6-SL, with
Ratchet Adjustment, Hi-Vis,
Orange, 6/Case**

3M Stock
V101553039
UPC
00076308421151

**3M™ Socket Dust Cap W-2119,
1 EA/Case**

3M Stock
7000005376
Previous 3M Stock
78800860625
UPC
00051138154899
Alternative ID
W-2119



**3M™ Solus™ 2000 Series
Safety Glasses**



**3M™ Speedglas™ 9100 FX-Air
Replacement Spring Mechanism
06-0400-56, 2 ea/Bag**

3M Stock
7100215111
UPC
00051131278332
Alternative ID
06-0400-56



**3M™ Gloves, GL100 Blue, 100
pairs per case**

3M Stock
7100095031
Previous 3M Stock
70200772526
UPC
50707387767810
Alternative ID
GL100



3M™ Protective Coverall 4520



**3M™ Secure Click™ Organic
Vapor Cartridge D8001, 60
ea/Case**

3M Stock
7100153170
UPC
00051131374669
Alternative ID
D8001



**3M™ Secure Click™ Multi-
Gas/Vapor Cartridge D8006, 60
ea/Case**

3M Stock
7100153228
UPC
00051141566627
Alternative ID
D8006



3M™ M-Series PAPR Helmet & Helmet Assemblies



3M™ DBI-SALA® Lad-Saf™ Cable Vertical Safety System Bracketry For Monopole 6116638, 4 User, Stainless Steel

3M Stock
7100248361
UPC
00840779174065
Alternative ID
6116638



3M™ DBI-SALA® Lad-Saf™ Cable Vertical Safety System Bracketry For Monopole 6116634, 4 User, Galvanized Steel

3M Stock
7100261158
UPC
00840779174027
Alternative ID
6116634



3M™ DBI-SALA® Permanent Roof Top Anchor For PVC Membrane/Built-Up 2100140, with Weather Proof Shroud

3M Stock
7100314284
UPC
00840779013371
Alternative ID
2100140



3M™ DBI-SALA® Lad-Saf™ Cable Vertical Safety System Bracketry with Telescoping Extension 6116618, 4 User, Galvanized Steel

3M Stock
7100261157
UPC
00840779152834
Alternative ID
6116618



3M™ DBI-SALA® Lad-Saf™ Cable Vertical Safety System Bracketry For Wood Pole 6116635, 2 User, Galvanized Steel

3M Stock
7100261159
UPC
00840779174034
Alternative ID
6116635



3M™ DBI-SALA® Web Scaffold Choker



3M™ DBI-SALA® Nano-Lok™ Connected Extended Length Order Picker Self-Retracting Lifeline Kit 3100273, Web, 11 ft

3M Stock
7100264408
UPC
00648250179369
Alternative ID
3100273



3M™ Scotchlite™ Reflective Material 8907 Silver Fabric, Config Roll

3M Stock
7100121726
Previous 3M Stock
75000203523
Alternative ID
8907



3M™ Welding Headbands & Headband Components



3M™ DBI-SALA® Confined Space Overload Clutch 8512936, 1 EA

3M Stock
7100204062
UPC
00840779006137
Alternative ID
8512936



3M™ DBI-SALA® Pole Climber's Adjustable Web Positioning Lanyard



**3M™ Speaking Diaphragm
Assembly FF-400-13, 5 EA/Case**

3M Stock
7000052742
Previous 3M Stock
70071516960
UPC
50051135894854
Alternative ID
FF-400-13



**3M™ Secure Click™ Speaking
Diaphragm Assembly,
HF-800-05, 5 EA/Bag**

3M Stock
7100181934
UPC
04054596622005
Alternative ID
HF-800-05



**3M™ Scott™ Air-Pak™ X3 Pro
SCBA**

3M Stock
B5005047169



**3M™ Speaking Diaphragm Kit
7895, 2 EA/Case**

3M Stock
7000051802
Previous 3M Stock
70070172112
UPC
50051138174946
Alternative ID
7895



**3M™ Scott™ Ska-Pak AT
Supplied-Air Respirator**

3M Stock
B5005047152



**3M™ Scott™ EPIC 3 RDI Voice
Communication System**

3M Stock
B5005046024



3M™ Replacement Filters for Lead Paint Removal Respirator, 7093H1-DC, 1 pair/pack, 5 packs/case

3M Stock
70006983384
UPC
00051141905211



3M™ DBI-SALA® Lad-Saf™ Cable Guide



3M™ Versaflo™ TR-600 & TR-800 Series PAPR Filters



3M™ Versaflo™ Radiant Heat Cover M-973, for M-307, 1 EA/Case

3M Stock
7100154129
UPC
00076308942724
Alternative ID
M-973N



3M™ Versaflo™ Radiant Heat Cover M-975N, for M-407, 1 EA/Case

3M Stock
7100154130
UPC
00076308942731
Alternative ID
M-975N



3M™ Shower Cover RBE-SC 2 EA/Case

3M Stock
7000126950
Previous 3M Stock
70071401932
UPC
50051131985464
Alternative ID
RBE-SC



**3M™ Versaflo™ PAPR Cover
TR-381, for TR-300+ PAPR, 10
ea/Case**

3M Stock
7100260719

UPC
50638060431974

Alternative ID
TR-381



**3M™ Versaflo™ PAPR Cover
TR-681, for TR-600/800 PAPR,
10 ea/Case**

3M Stock
7100260718

UPC
50638060432162

Alternative ID
TR-681



3M™ PAPR Batteries



**3M™ Breathing Tube Clamp
RBE-CMP 1 EA/Case**

3M Stock
7010340259

Previous 3M Stock
70071287851

UPC
00051131918962

Alternative ID
RBE-CMP



**3M™ E-A-R™ Pistonz™
Earplugs P1401, Corded, 400
Pair/Case**

3M Stock
7000127673

Previous 3M Stock
70071561495

UPC
10093045934024

Alternative ID
01401



**3M™ E-A-R™ Pistonz™
Earplugs P1400, Uncorded, 400
Pair/Case**

3M Stock
7000127672

Previous 3M Stock
70071561487

UPC
10093045934017

Alternative ID
01400



**3M™ DBI-SALA® Lad-Saf™
Cable Vertical Safety System
Label & Instructions**

3M Stock
B5005039019



**3M™ PELTOR™ Optime™ 105
Earmuffs**



**3M™ Versaflo™ Replacement
Visor Pivot Kit M-960, 1 Pair
EA/Case**

3M Stock
7000127694
Previous 3M Stock
70071562238
UPC
00051131173323
Alternative ID
M-960



**3M™ Versaflo™ Gold Coated
Tinted Over-Visor with UV/IR
Protection M-967N, 1 EA/Case**

3M Stock
7100154128
UPC
00076308942755
Alternative ID
M-967N



**3M™ Clip-on Welding Shield Kit
7990/7990-AM, Accessory 1
EA/Case**

3M Stock
7000126524
Previous 3M Stock
70071090149
UPC
00051131527898
Alternative ID
7990/7990-AM



**3M™ Hard Hat Suspension
Replacement H-700-PS4,
4-point Pinlock Standard, 20
EA/Case**

3M Stock
7000002422
Previous 3M Stock
70071578077
UPC
10078371642126
Alternative ID
H-700-PS4



3M™ Hard Hat Suspension Replacement H-700-RS4, 4-point Ratchet Standard, 20 EA/Case

3M Stock
7000002421
Previous 3M Stock
70071578069
UPC
10078371642119
Alternative ID
H-700-RS4



3M™ DBI-SALA® Rope Lifeline with Snap Hook



3M™ DBI-SALA® SecuraSpan™ I-Beam HLL Stanchion with Base 7400047, 1 ea

3M Stock
7100220291
UPC
00648250184288
Alternative ID
7400047



3M™ DBI-SALA® Nano-Lok™ Hot Work Self-Retracting Lifeline with Quick Connect 3100559, Web, Steel Rebar Lock Hook, 6 ft

3M Stock
7012818540
Previous 3M Stock
3100559
UPC
00648250242605
Alternative ID
3100559



3M™ DBI-SALA® Nano-Lok™ Hot Work Twin-Leg Personal Self-Retracting Lifeline 3100571, Kevlar® Fiber Web, 6 ft

3M Stock
7012818549
UPC
00648250242728
Alternative ID
3100571



3M™ DBI-SALA® Nano-Lok™ Hot Work Twin-Leg Personal Self-Retracting Lifeline 3100570, Kevlar® Fiber Web, 6 ft

3M Stock
7012818548
UPC
00648250242711
Alternative ID
3100570



3M™ DBI-SALA® Nano-Lok™
Hot Work Twin-Leg Personal
Self-Retracting Lifeline 3100567,
Kevlar® Fiber Web, 6 ft

3M Stock
7012818545

UPC
00648250242681

Alternative ID
3100567



3M™ DBI-SALA® Nano-Lok™
Hot Work Personal Self-
Retracting Lifeline 3100561,
Kevlar® Fiber Web, 6 ft

3M Stock
7012818541

UPC
00648250242629

Alternative ID
3100561



3M™ DBI-SALA® ExoFit™
X100 Safety Harness



3M™ DBI-SALA® Medium
Series Load Arrestor 3700800,
Galvanized Cable, 1760 lb
Capacity, 56 ft

3M Stock
7012771889

Previous 3M Stock
70007461042

Alternative ID
3700800



3M™ DBI-SALA® Small Series
Load Arrestor 3700300,
Galvanized Cable, 660 lb
Capacity, 40 ft

3M Stock
7012819495

UPC
00840779002511

Alternative ID
3700300



3M™ DBI-SALA® FlexiGuard™
M100 Permanent Mount Base



3M™ Adflo™ Powered Air
Purifying Respirator System with
3M™ Speedglas™ 9100 MP
Welding Helmet



3M™ W-Series Supplied Air
Regulator Valves & Assemblies



3M™ Hard Hat 150 Lumen Task
Light, HL200, 10 EA/Case

3M Stock
7010316628

Previous 3M Stock
70071676632

UPC
50051131275671

Alternative ID
HL200



3M™ Hard Hat 150 Lumen,
Intrinsically Safe Task Light,
HL300IS, 10 EA/Case

3M Stock
7010386282

Previous 3M Stock
70071676640

UPC
50051131275688

Alternative ID
HL300IS



3M™ Hard Hat 70 Lumen Task
Light, HL100, 10 EA/Case

3M Stock
7010386281

Previous 3M Stock
70071676624

UPC
50051131275664

Alternative ID
HL100



3M™ DBI-SALA® Rollgliss™
Rope Over Wire Automatic
Descent

3M Stock
B00033554



3M™ DBI-SALA® Drop-Thru Anchor



3M™ PELTOR™ ComTac™ V Headsets



3M™ Connected Safety ID Mechanical Mount HF RFID Tag CSID-HANG, 9505842, Yellow, 25/Pack, 1 ea/Case

3M Stock
7010386370

Previous 3M Stock
9505842

UPC
00051131274211

Alternative ID
RFID-HANG



3M™ Connected Safety ID Mechanical Mount HF RFID Tag CSID-MMTY, 9505839, Yellow, 25/Pack, 1 ea/Case

3M Stock
7010386287

UPC
00051131274204

Alternative ID
RFID-MMTY



3M™ Protecta® Self-Retracting Lifeline



3M™ Flat Temple Eyewear Anti-Scratch, 47011H1-DC, Black/Red, Gray Lens, 6/case

3M Stock
70006983046

UPC
00051141975887



3M™ DBI-SALA® Confined Space Lower Mast Extension for Upper Offset Davit Mast



3M™ E-A-R™ TaperFit™ 2 Earplugs



3M™ PELTOR™ Tactical Earplug TEP-100, 1 Kit EA/Case

3M Stock
7100066023

Previous 3M Stock
70071656287

UPC
00078371665258

Alternative ID
TEP-100



3M™ PELTOR™ Tactical Earplug TEP-300 CY, Coyote Brown

3M Stock
7100227650

Previous 3M Stock
70071734290

UPC
00638060429822

Alternative ID
TEP-300 CY



3M™ PELTOR™ Tactical Earplug, TEP-200

3M Stock
7010386290

UPC
00093045938247

Alternative ID
TEP-200



3M™ PELTOR™ Tactical Earplug TEP-300 GE, Grey

3M Stock
7100227633

UPC
00638060429860

Alternative ID
TEP-300 GE



3M™ Disposable Overboot Covers 450, Universal Size, 100 pairs/Case

3M Stock
7000088638

UPC
04046719121076

Alternative ID
450



3M™ PELTOR™ LiteCom Plus Headsets



3M™ E-A-Rflex™ 28 Banded Hearing Protector 320-1000, 100 EA/Case

3M Stock
7000127170

Previous 3M Stock
70071514866

UPC
10080529200065

Alternative ID
320-1000



3M™ Protective Coverall 4510



3M™ Scotchlite™ Reflective Material 8987NFPA Series



3M™ DBI-SALA® Tongue Buckle Restraint Belt 1000616, Yellow, X-Large

3M Stock
7012815004

Previous 3M Stock
1000616

UPC
00648250165553

Alternative ID
1000616



3M™ DBI-SALA® Tongue Buckle Restraint Belt 1000623, Yellow, 5X

3M Stock
7012815007
Previous 3M Stock
1000623
Alternative ID
1000623



3M™ DBI-SALA® Tongue Buckle Restraint Belt 1000166, Yellow, 2X

3M Stock
7012814971
Previous 3M Stock
1000166
UPC
00840779014347
Alternative ID
1000166



3M™ DBI-SALA® Derrick Tongue Buckle Positioning Belt with Pass-Thru Harness Connector 1000543, Yellow, Medium

3M Stock
7012814983
UPC
00648250165461
Alternative ID
1000543



3M™ DBI-SALA® Tongue Buckle Belt 1000052, Yellow, Small

3M Stock
7012814950
Previous 3M Stock
1000052
UPC
00648250160268
Alternative ID
1000052



3M™ DBI-SALA® Tongue Buckle Restraint Belt 1000613, Yellow, Small

3M Stock
7012814998
Previous 3M Stock
1000613
UPC
00648250165539
Alternative ID
1000613



3M™ DBI-SALA® ExoFit™ NEX Tongue Buckle Belt 1000778, Gray, X-Small

3M Stock
7012815021
Previous 3M Stock
1000778
UPC
00840779015344
Alternative ID
1000778



3M™ DBI-SALA® ExoFit™
Tongue Buckle Belt 1000717,
Gray, X-Large

3M Stock
7012815013
Previous 3M Stock
1000717
UPC
00648250165591
Alternative ID
1000717



3M™ DBI-SALA® Tongue
Buckle Restraint Belt with Hip
Pad 1000006, Yellow, 2X

3M Stock
7012814931
Previous 3M Stock
1000006
UPC
00840779014125
Alternative ID
1000006



3M™ DBI-SALA® ExoFit NEX™
Tongue Buckle Belt 1000784,
Gray, 3X

3M Stock
7012815027
Previous 3M Stock
1000784
UPC
00840779015405
Alternative ID
1000784



3M™ DBI-SALA® Tongue
Buckle Restraint Belt 1000612,
Yellow, X-Small

3M Stock
7012814996
Previous 3M Stock
1000612
UPC
00648250165522
Alternative ID
1000612



3M™ DBI-SALA® Tongue
Buckle Restraint Belt 1000058, Yellow, 4X

3M Stock
7012814956
Previous 3M Stock
1000058
UPC
00840779014293
Alternative ID
1000058



3M™ DBI-SALA® Tongue
Buckle Restraint Belt 1000618,
Yellow, 3X

3M Stock
7012815006
Previous 3M Stock
1000618
UPC
00840779015016
Alternative ID
1000618



3M™ DBI-SALA® Tongue Buckle Restraint Belt 1000162, Yellow, Small

3M Stock
7012814963
Previous 3M Stock
1000162
UPC
00840779007523
Alternative ID
1000162



3M™ DBI-SALA® ExoFit NEX™ Tongue Buckle Belt 1000781, Gray, Large

3M Stock
7012815024
Previous 3M Stock
1000781
UPC
00840779015375
Alternative ID
1000781



3M™ DBI-SALA® Tongue Buckle Positioning Belt with Hip Pad 1000025, Yellow, X-Large

3M Stock
7012814944
Previous 3M Stock
1000025
UPC
00840779004393
Alternative ID
1000025



3M™ DBI-SALA® Tongue Buckle Restraint Belt 1000163, Yellow, Medium

3M Stock
7012814965
Previous 3M Stock
1000163
UPC
00648250165416
Alternative ID
1000163



3M™ DBI-SALA® Tongue Buckle Positioning Belt with Hip Pad 1000022, Yellow, Small

3M Stock
7012814938
Previous 3M Stock
1000022
UPC
00648250166673
Alternative ID
1000022



3M™ DBI-SALA® Tongue Buckle Restraint Belt 1000614, Yellow, Medium

3M Stock
7012815000
Previous 3M Stock
1000614
UPC
00648250165546
Alternative ID
1000614



**3M™ DBI-SALA® Derrick
Tongue Buckle Positioning Belt
with Pass-Thru Harness
Connector 1000544, Yellow,
Large**

3M Stock
7012814984

UPC
00648250165478

Alternative ID
1000544



**3M™ DBI-SALA® Tongue
Buckle Positioning Belt with Hip
Pad 1000028, Yellow, 4X**

3M Stock
7012814949

Previous 3M Stock
1000028

UPC
00840779014200

Alternative ID
1000028



**3M™ DBI-SALA® Tongue
Buckle Restraint Belt with Hip
Pad 1000007, Yellow, 3X**

3M Stock
7012814933

Previous 3M Stock
1000007

UPC
00840779014132

Alternative ID
1000007



**3M™ DBI-SALA® Tongue
Buckle Restraint Belt 1000161,
Yellow, X-Small**

3M Stock
7012814961

Previous 3M Stock
1000161

UPC
00648250165409

Alternative ID
1000161



**3M™ DBI-SALA® Delta™
Tongue Buckle Belt 1000051,
X-Small, 1 EA/Case**

3M Stock
70007400073

UPC
00648250160275

Alternative ID
1000051



**3M™ DBI-SALA® Tongue
Buckle Restraint Belt with Hip
Pad 1000008, Yellow, 4X**

3M Stock
7012814934

Previous 3M Stock
1000008

UPC
00840779014149

Alternative ID
1000008



3M™ DBI-SALA® Tongue Buckle Positioning Belt with Hip Pad 1000021, Yellow, X-Small

3M Stock
7012814936
Previous 3M Stock
1000021
UPC
00648250165348
Alternative ID
1000021



3M™ DBI-SALA® Derrick Tongue Buckle Positioning Belt with Pass-Thru Harness Connector 1000545, Yellow, X-Large

3M Stock
7012693281
UPC
00648250165485
Alternative ID
1000545



3M™ DBI-SALA® Derrick Tongue Buckle Positioning Belt with Tongue Buckle Harness Connector 1003223, Yellow, 2X

3M Stock
7012815133
UPC
00840779016662
Alternative ID
1003223



3M™ DBI-SALA® Derrick Tongue Buckle Positioning Belt with Tongue Buckle Harness Connector 1003222, Yellow, X-Large

3M Stock
7100241696
UPC
00648250165713
Alternative ID
1003222



3M™ DBI-SALA® ExoFit NEX™ Tongue Buckle Belt 1000785, Gray, 4X

3M Stock
7012815028
Previous 3M Stock
1000785
UPC
00840779015412
Alternative ID
1000785



3M™ DBI-SALA® Handline Keeper For Lineman Belt 9509844, Yellow

3M Stock
7012821940
Previous 3M Stock
9509844
Alternative ID
9509844



3M™ DBI-SALA® Derrick Positioning Belt with Pass-Thru Suspension Strap Harness Connector 1000573, Yellow, Medium

3M Stock
7012814992

Alternative ID
1000573



3M™ DBI-SALA® Derrick Tongue Buckle Positioning Belt with Tongue Buckle Harness Connector 1003230, Yellow, Small

3M Stock
7012815135

Previous 3M Stock
1003230

UPC
00648250165720

Alternative ID
1003230



3M™ DBI-SALA® Tongue Buckle Restraint Belt with Hip Pad 1000009, Yellow, 5X

3M Stock
7012814935

Previous 3M Stock
1000009

UPC
00840779014156

Alternative ID
1000009



3M™ DBI-SALA® ExoFit NEX™ Tongue Buckle Belt 1000779, Gray, Small

3M Stock
7012815022

Previous 3M Stock
1000779

UPC
00840779015351

Alternative ID
1000779



3M™ DBI-SALA® Tongue Buckle Positioning Belt with Hip Pad 1000027, Yellow, 3X

3M Stock
7012814948

Previous 3M Stock
1000027

UPC
00840779014194

Alternative ID
1000027



3M™ DBI-SALA® Parachute Buckle Web Boom Belt 1001250, Polyester, 4 ft

3M Stock
7012815087

Previous 3M Stock
1001250



3M™ DBI-SALA® Tongue Buckle Restraint Belt 1000617, Yellow, 2X

3M Stock
7012815005
Previous 3M Stock
1000617
UPC
00840779015009
Alternative ID
1000617



3M™ DBI-SALA® Tongue Buckle Belt 1000053, Yellow, Medium

3M Stock
7012814951
Previous 3M Stock
1000053
UPC
00840779004409
Alternative ID
1000053



3M™ DBI-SALA® Tongue Buckle Belt 1000054, Yellow, Large

3M Stock
7012814952
Previous 3M Stock
1000054
UPC
00840779000067
Alternative ID
1000054



3M™ DBI-SALA® Tongue Buckle Restraint Belt 1000615, Yellow, Large

3M Stock
7012815002
Previous 3M Stock
1000615
UPC
00840779004423
Alternative ID
1000615



3M™ DBI-SALA® Tongue Buckle Positioning Belt with Hip Pad 1000023, Yellow, Medium

3M Stock
7012814940
UPC
00840779004379
Alternative ID
1000023



3M™ DBI-SALA® Tongue Buckle Restraint Belt 1000165, Yellow, X-Large

3M Stock
7012814969
Previous 3M Stock
1000165
UPC
00648250165430
Alternative ID
1000165



**3M™ DBI-SALA® ExoFit™
Tongue Buckle Belt 1000716,
Gray, Large**

3M Stock
7012815012

UPC
00840779007738

Alternative ID
1000716



**3M™ DBI-SALA® Steel
Structure Remote Anchor
System 2104810, 80 ft**

3M Stock
7012818347

UPC
00840779013364

Alternative ID
2104810



**3M™ Protecta® Dual-Ring
Cable Tie-Off Adaptor**



**3M™ Modul-R™ Safety Goggle,
40658-00000-10 Clear Anti Fog
Lens with Chin Protector 10
ea/case**

3M Stock
B00040558

UPC
10078371620971



**3M™ Speedglas™ FA III SAR
V-100 Valve and Speedglas™
Welding Helmet 9100-Air,
25-5702-00SW (No ADF), 1
EA/CS**

3M Stock
7100194537

UPC
00051131277830

Alternative ID
25-5702-00SW



**3M™ Speedglas™ FA III SAR
with V-100 Valve and 9100-Air
Welding Helmet 25-5702-30iSW,
ADF 9100XXi, 1 EA/Case**

3M Stock
7010342473

Previous 3M Stock
70071688587

UPC
00051141564777

Alternative ID
25-5702-30iSW



3M™ PELTOR™ CH-3 Headset
MT74H52P3E-110, Hard Hat
Attached, FLX2, 1 ea/Case

3M Stock
7100203635
UPC
04054596695634
Alternative ID
MT74H52P3E-110



3M™ PELTOR™ CH-3 Headset
MT74H52B-110, Neckband,
FLX2, 1 ea/Case

3M Stock
7100203636
UPC
04054596695603
Alternative ID
MT74H52B-110



3M™ Speedglas™ Magnifying
Lens Holder 07-0680-00, for 100
Series Welding Helmets, 2
EA/Case

3M Stock
7000127452
Previous 3M Stock
70071534096
UPC
50051131171959
Alternative ID
07-0680-00



3M™ Speedglas™ Magnifying
Lens Holder 05-0680-00, for SL
Series Welding Helmets, 1
EA/Case

3M Stock
7100077601
Previous 3M Stock
70071534278
UPC
00051131172159
Alternative ID
05-0680-00



3M™ Scotchlite™ Reflective
Tape, 03456, 2 in x 36 in, 24 per
case

3M Stock
60455056964
UPC
00051131034563
Alternative ID
03456



3M™ Scotchlite™ Reflective
Tape, 03459, 2 in x 36 in, 24 per
case

3M Stock
60455056972
UPC
00051131034594
Alternative ID
03459



**3M™ E-A-RSoft™ FX™ Probed
Test Plugs 393-2004-50, 50
EA/Case**

3M Stock
7000052883
Previous 3M Stock
70071562782
UPC
10080529190779
Alternative ID
393-2004-50



**3M™ Speedglas™ G5 Non-Air
Welding Helmet Task Light
Battery Holder 10-0500-03**

3M Stock
7100312001
Previous 3M Stock
70100400137
UPC
00638060430675
Alternative ID
10-0500-03



**3M™ Speedglas™ G5
Replacement Task Light
46-0500-06, No Power Cables
Included**

3M Stock
7100314379
Previous 3M Stock
70100400384
UPC
00638060430774
Alternative ID
46-0500-06



**3M™ Speedglas™ G5 Non-Air
Welding Helmet Task Light Kit
10-0500-01, including Light,
Battery, and Cables, 1 EA/Case**

3M Stock
7100311951
Alternative ID
10-0500-01



**3M™ Speedglas™ G5-01 Task
Light Kit, including Light,
Protection Plate, and Cables,
46-0500-01, 1 EA/Bag**

3M Stock
7100217200
UPC
00076308944742
Alternative ID
46-0500-01



**3M™ Half Facepiece Respirator
Packout 07182, Medium, with
3M™ Particulate Filters PN
07184, P100**

3M Stock
7000126240
UPC
00051131071827
Alternative ID
07182



3M™ Half Facepiece Respirator Packout PN 07183, Large, with 3M™ Particulate Filters PN 07184, P100

3M Stock
7000126241
Previous 3M Stock
70070797793
UPC
00051131071834
Alternative ID
07183



3M™ Professional Series Half Facepiece Paint Spray Packout 37078, Medium 4 EA/Case

3M Stock
7010384301
Previous 3M Stock
70071090289
UPC
00051131370784
Alternative ID
37078



3M™ Shroud 7915-5/7915-5-AM, Accessory 5 EA/Case

3M Stock
7000126022
Previous 3M Stock
70070314177
UPC
50051138215557
Alternative ID
7915-5/7915-5-AM



3M™ Buckle FF-400-01, 30 EA/Case

3M Stock
7000052734
Previous 3M Stock
70071516846
UPC
50051135894731
Alternative ID
FF-400-01



3M™ Solus™ CCS Series Safety Glasses



3M™ Span Gas Cylinder 529-05-19, 1 EA/Case

3M Stock
7000131707
Previous 3M Stock
78812400154
UPC
00051138720155
Alternative ID
-500607



**3M™ Span Gas Cylinder
529-05-16, Large, 1 EA/Case**

3M Stock
7000126386
Previous 3M Stock
70070888816
UPC
00051138727895
Alternative ID
-500610



**3M™ Head Suspension
W-2878-2/07041(AAD), 2/Case**

3M Stock
7000130787
Previous 3M Stock
78805232036
UPC
50051131070412
Alternative ID
W-2878-2



**3M™ Versaflo™ Premium Head
Suspension, S-950, for S-600
S-700 and S-800 Hood
Assemblies, 1 EA/Case**

3M Stock
7100005445
Previous 3M Stock
70071533395
Alternative ID
S-950



**3M™ Versaflo™ Replacement
Head Suspension
M-150/37316(AAD), for M-100
Face Shields, 1 EA/Case**

3M Stock
7000127601
Previous 3M Stock
70071544954
UPC
00051131373167
Alternative ID
M-150



**3M™ Ratchet Suspension
W-2879 1 EA/Case**

3M Stock
7000126090
Previous 3M Stock
70070514339
UPC
50051138291643
Alternative ID
W-2879



**3M™ Retrofit CO Monitor Kit
W-2808/37027(AAD), 1 EA/Case**

3M Stock
7000126402
Previous 3M Stock
70070889939
UPC
00051131370272
Alternative ID
W-2808

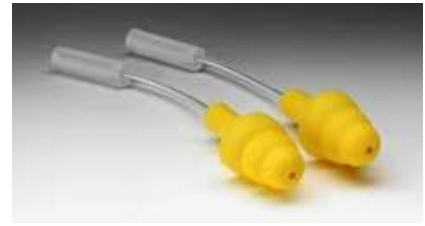

3M™ Air-Mate™ Breathing Tube Assembly BE-224 (Formerly 008-00-14R01) Light Duty 1 EA/Case

3M Stock
7000005588
Previous 3M Stock
78812400642
UPC
00051138720643
Alternative ID
BE-224

3M™ Breathing Tube Assembly 520-01-00R01, 1 EA/Case

3M Stock
7000131721
Previous 3M Stock
78812400790
UPC
00051138720797
Alternative ID
520-01-00R01

3M™ E-A-R™ UltraFit™ Probed Test Plugs 393-2001-50, 50 EA/Case

3M Stock
7000002387
Previous 3M Stock
70071562758
UPC
10080529190748
Alternative ID
393-2001-50



3M™ Speedglas™ Welding Beanie 06-0500-54, 10 EA/Case

3M Stock
7000127141
Previous 3M Stock
70071510377
UPC
50051135893789
Alternative ID
06-0500-54



3M™ PELTOR™ Hi-Viz Earmuffs H31P3E, Hard Hat Attached, 10 EA/Case

3M Stock
7000141054
Previous 3M Stock
XH001651195
UPC
07318640051638
Alternative ID
H31P3E



3M™ PELTOR™ Hi-Viz Earmuffs H31A, Over-the-Head, 10 EA/Case

3M Stock
7000141055
Previous 3M Stock
XH001651203
UPC
07318640051645
Alternative ID
H31A



**3M™ Solus™ 1000 Series
Safety Glasses Kit**



**3M™ Protecta® Rope Adjuster
with Lanyard**



**3M™ PELTOR™ X1 Earmuffs
X1B, Behind-the-Head, 10
EA/Case**

3M Stock
7100123140

Previous 3M Stock
UU008197715

UPC
10078371671270

Alternative ID
X1B



**3M™ PELTOR™ Earmuffs
X1P5E, Forestry Orange, 10
EA/Case**

3M Stock
7100097447

Previous 3M Stock
UU007831611

UPC
10078371671171

Alternative ID
X1P5E



**3M™ PELTOR™ X1 Earmuffs
X1P51E, Hard Hat Attached, 10
EA/Case**

3M Stock
7100135816

Previous 3M Stock
UU008938514

UPC
10078371671355



**3M™ Faceshield Cover
H-110-10/07042(AAD) 10
ea/Bag**

3M Stock
7100138614

Previous 3M Stock
70070798015

UPC
50051131070429

Alternative ID
H-110-10



3M™ Headgear



3M™ DBI-SALA® FlexiGuard™
C-Frame System, Adjustable
Height



3M™ Peltor™ Hard Hat Adapter
for Visors P3EV/2, Face
Protection 5 PAIR/Case

3M Stock
7000103847

Previous 3M Stock
XA007704712

UPC
10093045936349

Alternative ID
P3EV/2-10P



3M™ Clear Acetate Visor
V3F-10P 10 EA/Case

3M Stock
7000103814

Previous 3M Stock
XA007704159

UPC
10093045936226

Alternative ID
V3F-10P



3M™ DBI-SALA® Secondary
Pad Air Hose 2200130

3M Stock
7100226843

Previous 3M Stock
2200130

UPC
00648250160404

Alternative ID
2200130



3M™ DBI-SALA® Permanent
Multi-Span Horizontal Lifeline
System



3M™ ForceFlex™ Eyewear,
92235H1-DC, Black, Gray Lens,
Anti-Scratch, 4/case

3M Stock
70006989456

UPC
00051141390628



3M™ Scott™ Industrial SCBA
(ISCBA)

3M Stock
B5005047159



3M™ DBI-SALA® Sealed-Blok™
3-Way Retrieval Self-Retracting
Lifeline 3400167, Stainless Steel
Cable, 85 ft

3M Stock
7100323507

UPC
00648250253359
Alternative ID
3400167



3M™ DBI-SALA® Sealed-Blok™
3-Way Retrieval Self-Retracting
Lifeline with Bracket 3400168,
Stainless Steel Cable, 85 ft.

OSHA

3M Stock
7100324055

UPC
00648250253366
Alternative ID
3400168



3M™ DBI-SALA® Sealed-Blok™
RSQ Self-Retracting Lifeline
3400162, Stainless Steel Cable,
50 ft

3M Stock
7012818930

UPC
00648250244319

Alternative ID
3400162



3M™ DBI-SALA® Sealed-Blok™
RSQ 3-Way Retrieval Self-
Retracting Lifeline 3400165,
Stainless Steel Cable, 50 ft

3M Stock
7012818933

UPC
00648250244340

Alternative ID
3400165



**3M™ DBI-SALA® Sealed-Blok™
Self Retracting Lifeline 3400147,
Retrieval, Galvanized Cable, 50
ft. (15m)**

3M Stock
7100313071

UPC
00648250244166

Alternative ID
3400147



**3M™ PELTOR™ COMTAC™
ACH Single Comm Kit, SOCOM,
Coyote Brown 88900-00000, 1
EA/Case**

3M Stock
7010342079

Previous 3M Stock
70071613890

UPC
00093045936151

Alternative ID
88900-00000



**3M™ PELTOR™ COMTAC™
ACH Dual Comm Kit - SOCOM,
Coyote Brown, 88901-000001
EA/Case**

3M Stock
7010384664

Previous 3M Stock
70071613882

UPC
00093045936144

Alternative ID
88901-00000



**3M™ DBI-SALA® Sealed-Blok™
Self Retracting Lifeline 3400131,
Stainless Steel Cable, 15 ft. (4.5
m)**

3M Stock
7100306997

UPC
00648250244005

Alternative ID
3400131



**3M™ DBI-SALA® Sealed-Blok™
3 Retrieval Self-Retracting
Lifeline 3400146, Rope, 30 ft.**

3M Stock
7100333618

Previous 3M Stock
70804108390

UPC
00648250244159

Alternative ID
3400146



**3M™ DBI-SALA® Sealed-Blok™
3-Way Retrieval Self-Retracting
Lifeline with Bracket 3400150,
Stainless Steel Cable, Snap
Hoo...**

3M Stock
7100318433

UPC
00648250244197

Alternative ID
3400150



3M™ DBI-SALA®
Rescue/Retrieval Web
Y-Lanyard 1231470, 2 ft

3M Stock
7012817060
UPC
00840779010783
Alternative ID
1231470



3M™ DBI-SALA®
SecuraSpan™ Pour-in-
Place/Fasten-in-Place HLL
Stanchion 7400203, 1 ea

3M Stock
7100220294
UPC
00840779004782
Alternative ID
7400203



3M™ DBI-SALA® Salalift™ II
Winch



3M™ Protecta® Sliding Beam
Anchor



3M™ DBI-SALA® Self Locking
Carabiner

3M | Connected Safety

**On-site Training
& Implementation**

3M™ Health, Safety and
Compliance Software
Implementation, 1 Day

3M Stock
6010002882
Previous 3M Stock
70-9999-8656-8
Alternative ID
SIM-TRN-ONSITE



3M™ Versaflo™ TR-800 Series
PAPR Systems



3M™ SecureFit™ Protective
Eyewear 200 Series



3M™ Virtua™ AP Safety
Glasses



3M™ Training and Fit Testing
Kits



3M™ Pressure Relief Valve
W-1596 1 EA/Case

3M Stock
7100110738
UPC
00051138153717
Alternative ID
W-1596



3M™ DBI-SALA® Energy
Absorbing Lanyards



3M™ Socket W-3182-2, 1/4 in Body Size, 3/8 in MPT, Schrader 2/Case

3M Stock
7000130788

Previous 3M Stock
78805232150

UPC
50051138214789

Alternative ID
W-3182-2



3M™ Socket W-3184-2, 1/4 in Body Size, 1/4 in FPT, Industrial Interchange 2 EA/Case

3M Stock
7000056515

Previous 3M Stock
78805232176

UPC
50051138214802

Alternative ID
W-3184-2



3M™ Socket W-3185-2, 1/4 in Body Size, 1/4 in FPT, Schrader 2/Case

3M Stock
7000130790

Previous 3M Stock
78805232184

UPC
50051138214819

Alternative ID
W-3185-2



3M™ Socket W-3280-2, 1/4 in Body Size, 1/4 in FPT, Industrial Interchange 2/Case

3M Stock
7000051867

Previous 3M Stock
70070405694

UPC
00051138289867

Alternative ID
W-3280-2



3M™ Socket W-3224-2/07158(AAD), 3/8 in Body Size, 3/8 in FPT, Industrial Interchange 2/Case

3M Stock
7000130990

Previous 3M Stock
78806024788

UPC
50051138213867

Alternative ID
W-3224-2



3M™ Socket W-3281-2, 1/4 in Body Size, 3/8 in MPT, Industrial Interchange, 2/Case

3M Stock
7000051866

Previous 3M Stock
70070405686

UPC
00051138289850

Alternative ID
W-3281-2



3M™ Socket W-1449-2, 1/4 in Body Size, 3/8 in MPT, Industrial Interchange, 2/Case

3M Stock
7000005401
Previous 3M Stock
78805232226
UPC
50051138165685
Alternative ID
W-1449-2

3M™ Socket W-3199-2/07157(AAD), 1/2 in Body Size, 3/8 in FPT, Schrader 2/Case

3M Stock
7100017457
Previous 3M Stock
78805233281
UPC
50051131071570
Alternative ID
W-3199-2

3M™ DBI-SALA® Concrete Bolt Fastener Kit For Roof Top Anchor 7241180, 150 mm, 4 ea/Pack

3M Stock
7100241075
UPC
00840779013043
Alternative ID
7241180



3M™ DBI-SALA® Concrete Bolt Fastener Kit For Roof Top Anchor 7241181, 300 mm, 4 ea/Pack

3M Stock
7100241076
UPC
00840779103461
Alternative ID
7241181

3M™ DBI-SALA® Confined Space Portable Fall Arrest Post

3M™ Performance Reusable Paint Project Respirator OV/P95, 6111P1-DC, Size Small, 1 each/pack, 4 packs/case

3M Stock
70006985629
UPC
00051138542504



**3M™ DBI-SALA® Winch/SRL
Mounting Bracket 8510224**

3M Stock
7100226853
Previous 3M Stock
8510224
UPC
00840779005772
Alternative ID
8510224



**3M™ PELTOR™ Microphone
Post A44**

3M Stock
7000107796
Previous 3M Stock
XH001651724
UPC
07318640066724
Alternative ID
A44



**3M™ PELTOR™ Audio Input
Cable FL6H, 3.5mm Mono Plug
1 EA/Case**

3M Stock
7000107805
Previous 3M Stock
XH001652078
UPC
07318640000629
Alternative ID
FL6H



**3M™ PELTOR™ Patch Cord
FL6CT, 1 ea/cs**

3M Stock
7100064519
Previous 3M Stock
XH001652060
UPC
07318640042735
Alternative ID
FL6CT



**3M™ PELTOR™ Audio Input
Cable FL6N, 3.5mm Stereo Plug
1 EA/Case**

3M Stock
7100064600
Previous 3M Stock
XH001652110
UPC
07318640034051
Alternative ID
FL6N



**3M™ PELTOR™ Audio Input
Cable FL6H-03, 3.5mm Mono
Plug, 50 ea/Case**

3M Stock
7000141073
Previous 3M Stock
XH001652086
UPC
07318640033719
Alternative ID
FL6H-03



3M™ PELTOR™ Audio Input Cable FL6M-03, 2.5mm Mono Plug, 1 ea/cs

3M Stock
7000141074
Previous 3M Stock
XH001652102
UPC
07318640033726
Alternative ID
FL6M-03



3M™ PELTOR™ Extension Cables 88058-00000, 1 EA/Case

3M Stock
7010340656
Previous 3M Stock
70071557378
UPC
10093045933072
Alternative ID
88058-00000



3M™ PELTOR™ Communication Cable Kit 88055-00000, for FM53, M50, C50 Protective Masks, 1 EA/Case

3M Stock
7010342068
Previous 3M Stock
70071612199
UPC
00093045935260
Alternative ID
88055-00000



3M™ PELTOR™ Audio Input Cable FL6M, 2.5mm Mono Plug, 1 ea/cs

3M Stock
7000107806
Previous 3M Stock
XH001652094
UPC
07318640010956
Alternative ID
FL6M



3M™ Disposable Protective Coverall 4530



3M™ PELTOR™ ARC, Left & Right Side Attachments, 1 EA/Case

3M Stock
7000128144
Previous 3M Stock
70071612389
UPC
00093045935338
Alternative ID
ARC

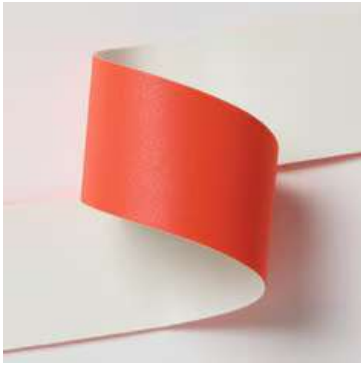

3M™ Scotchlite™ Reflective Material 8986NFPA Series



3M™ DBI-SALA® Rollgliss™ Descender, Sloped/Auto Retract



3M™ DBI-SALA® E Maxi Clamp 4-Pack for Standing Seam Roof Top Anchor 7241206, Silver, 1 Pack

3M Stock
7100216316

UPC
00840779013098

Alternative ID
7241206



3M™ DBI-SALA® Z Maxi Clamp Fastener Kit For Roof Top Anchor 7241204, Fits Bulb Standing Seam, 4 ea/Pack

3M Stock
7100280773

UPC
00840779013081

Alternative ID
7241204



3M™ Centurion™ 452 Series Safety Impact Goggles



3M™ Speedglas™ Welding Helmet 100 QR, 07-0112-00BL-QR, Without Rail, Hardhat, ADF, 1 EA/CASE

3M Stock
7100200571

UPC
00076308943783

Alternative ID
07-0112-00BL-QR



**3M™ Scotchlite™ Reflective
Material 9587 Series**



**3M™ Scotchlite™ Reflective
Material 8935 Series**



**3M™ Speedglas™ G5-03
Pro/Air Side Windows
Coverplate 10-0500-53**

3M Stock
7100312605

Previous 3M Stock
70100400061

UPC
00638060430651

Alternative ID
10-0500-53



**3M™ Speedglas™
SideWindows Coverplate 9100
06-0500-53, 2 EA/Case**

3M Stock
7000127140

Previous 3M Stock
70071510369

UPC
50051135893772

Alternative ID
06-0500-53



**3M™ Speedglas™ G5 Task
Light Pouch for 3M™ Adflo™
Battery, 35-1099-00**

3M Stock
7100216922

Previous 3M Stock
70071735974

UPC
00076308944926

Alternative ID
35-1099-00



**3M™ Speedglas™ Protective
Bag 06-0500-65, 1 EA/Case**

3M Stock
7000128219

Previous 3M Stock
70071621422

UPC
00051131494787

Alternative ID
06-0500-65



3M™ Speedglas™ Heavy-Duty Back Pack BPK-HD, 3 ea/Case

3M Stock
7100282441

UPC
04064035055950

Alternative ID
BPK-HD



3M™ Rugged Comfort Quick Latch Half Facepiece Reusable Respirator 6503QL/49492, Large, 10 EA/Case

3M Stock
7000128241

Previous 3M Stock
70071621869

UPC
50051131494928

Alternative ID
6503QL



3M™ DIN Port Adapter Assembly 6884, 5 EA/Case

3M Stock
7000002032

Previous 3M Stock
70070709087

UPC
50051138541496

Alternative ID
6884



3M™ Full Face Plug 7890, Replacement Part 20 EA/Case

3M Stock
7000029584

Previous 3M Stock
70070079150

UPC
50021200603315

Alternative ID
7890



3M™ Half Facepiece Disposable Respirator Assembly 51P71, Organic Vapor, P95, Small 12 EA/Case

3M Stock
7000052079

Previous 3M Stock
70070797173

UPC
50051138660685

Alternative ID
51P71



3M™ Half Facepiece Disposable Respirator Assembly 5201, Organic Vapor, Medium 12 EA/Case

3M Stock
7000126026

Previous 3M Stock
70070314466

UPC
50051138215717

Alternative ID
5201



3M™ Half Facepiece Disposable Respirator Assembly 5301, Organic Vapor, Large 12 EA/Case

3M Stock
7000126027

Previous 3M Stock
70070314524

UPC
50051138215779

Alternative ID
5301



3M™ Half Facepiece Disposable Respirator Assembly 5303, Organic Vapor/Acid Gas, Large 12 EA/Case

3M Stock
7000051848

Previous 3M Stock
70070314540

UPC
50051138215793

Alternative ID
5303



3M™ Half Facepiece Disposable Respirator Assembly 5203, Organic Vapor/Acid Gas, Medium 12 EA/Case

3M Stock
7000051847

Previous 3M Stock
70070314482

UPC
50051138215731

Alternative ID
5203



3M™ Half Facepiece Disposable Respirator Assembly 53P71, Organic Vapor/P95 Respiratory Protection, Large 12 EA/Case

3M Stock
7000052081

Previous 3M Stock
70070797199

UPC
50051138660708

Alternative ID
53P71



3M™ Half Facepiece Disposable Respirator Assembly 5101, Organic Vapor, Small 12 EA/Case

3M Stock
7000126024

Previous 3M Stock
70070314409

UPC
50051138215656

Alternative ID
5101



3M™ Half Facepiece Disposable Respirator Assembly 5103, Organic Vapor/Acid Gas, Small 12 EA/Case

3M Stock
7000126025

Previous 3M Stock
70070314425

UPC
50051138215670

Alternative ID
5103



3M™ Versaflo™ Plug W-3186-2,
1/4 in Body Size, 1/4 in MPT
Schrader, 2 ea/Case

3M Stock
7000130791
Previous 3M Stock
78805232192
UPC
50051138214826
Alternative ID
W-3186-2

3M™ Plug
W-3057-2/07155(AAD), 3/8 in
Body Size, 3/8 in FPT, Industrial
Interchange 2/Case

3M Stock
7000130989
Previous 3M Stock
78806024101
UPC
50051131071556
Alternative ID
W-3057-2

3M™ Schrader Plug W-3183-2,
1/4 in Body Size, 1/4 in FPT,
Schrader 2 Plugs/Pkg

3M Stock
7000130789
Previous 3M Stock
78805232168
UPC
00051138214791
Alternative ID
W-3183-2



3M™ Versaflo™ Plug W-1279-2,
1/4 in Body Size, 1/4 in MPT,
Industrial Interchange 2
EA/Case

3M Stock
7000005400
Previous 3M Stock
78805232218
UPC
00051138164294
Alternative ID
W-1279-2

3M™ Versaflo™ Plug W-3252-2,
3/8 in Body Size, 1/4 in MPT,
Industrial Interchange, 2
ea/Case

3M Stock
7000130793
Previous 3M Stock
78805233299
UPC
00051138214937
Alternative ID
W-3252-2

3M™ Plug W-3080-2, 1/4 in
Body Size, 1/4 in FPT, Industrial
Interchange 2/Case

3M Stock
7000005399
Previous 3M Stock
78805232200
UPC
50051138214673
Alternative ID
W-3080-2



**3M™ Plug W-3279-2, 1/4 in
Body Size, 1/4 in FPT, Industrial
Interchange 2/Case**

3M Stock
7000051868
Previous 3M Stock
70070405702
UPC
00051138289874
Alternative ID
W-3279-2

**3M™ Plug
W-3198-2/07156(AAD), 1/2 in
Body Size, 3/8 in FPT, Schrader
2/Case**

3M Stock
7100017458
Previous 3M Stock
78805233273
UPC
50051131071563
Alternative ID
W-3198-2

**3M™ Versaflo™ Plug W-3251-2,
1/2 in Body Size, 1/4 in MPT,
Schrader 2 EA/Case**

3M Stock
7010346759
UPC
00051138213275
Alternative ID
W-3251-2



**3M™ Versaflo™ Storage Plugs
BT-957 5/CS**

3M Stock
7100176778
UPC
00051131278400
Alternative ID
BT-957

**3M™ PAPER Battery Chargers &
Charging Components**

**3M™ Adflo™ Rubber Breathing
Tube Rubber O-Ring
15-0099-12, 2 ea/Bag**

3M Stock
7000126796
Previous 3M Stock
70071275021
UPC
00051131932517
Alternative ID
15-0099-12



**3M™ Aura Healthcare
Particulate Respirator 1800+
Series**



**3M™ E-A-Rfit™ Dual-Ear
Enclosure Assembly Speaker
073-783**

3M Stock
7100077866
Previous 3M Stock
70071674686
UPC
00078371670139
Alternative ID
073-783



**3M™ Infant Eartip 4.0mm
420-2095, 10 Pair EA/Case**

3M Stock
7100133268
Previous 3M Stock
70071647021
UPC
10080529510119
Alternative ID
420-2095



3M™ No-Touch™ Earplugs



**3M™ PELTOR™ Optime™ 101
Earmuffs H7B, Behind-the-Head,
10 EA/Case**

3M Stock
7000002329
Previous 3M Stock
70071517158
UPC
10093045080721
Alternative ID
H7B



**3M™ Squeeze Clamp
W-3222-2/07036(AAD) 2
Clamps/Bag**

3M Stock
7000056528
Previous 3M Stock
78806025025
UPC
50051131070368
Alternative ID
W-3222-2



**3M™ Versaflo™ Over-visor
Frame M-961N, 1 EA/Case**

3M Stock
7100154127
UPC
00076308942748
Alternative ID
M-961N



**3M™ Integrated Protective
Eyewear**



**3M™ Quick Release Locking
Detent Pin 9503317, 5/16 in x
3.7 in**

3M Stock
7100312867
Alternative ID
9503317



**3M™ DBI-SALA® Flexiguard™
A-Frame Rail Adjustable Height
Anchor System 8517781, 2
User, Yellow, 16 - 22.5 ft Height,
30 f...**

3M Stock
7100231969
UPC
00840779099832
Alternative ID
8517781



**3M™ GoggleGear™ 500-Series
Replacement Cloth Strap, 10
EA/Case**

3M Stock
7010341344
Previous 3M Stock
70071676574
UPC
50051131275626
Alternative ID
GG500-ClthStrap



**3M™ GoggleGear™ 500-Series
Replacement Neoprene Strap,
10 EA/Case**

3M Stock
7010316627
Previous 3M Stock
70071676558
UPC
50051131275602
Alternative ID
GG500-NeoStrap



3M™ Tour-Guard™ III Safety
Overspectacles



3M™ Nebulizer FT-13, 3
EA/Case

3M Stock
7000001897

Previous 3M Stock
70070121473

UPC
50051138163575

Alternative ID
FT-13



3M™ DBI-SALA® Rollgliss™
R550 Rescue and Descent
Device



3M™ DBI-SALA® Confined
Space Adjustable Offset Upper
Davit Mast



3M™ Peltor™ Rechargeable
Battery Pack, 88009-00000, 1
ea/cs

3M Stock
7000052756

Previous 3M Stock
70071524600

UPC
00093045880096

Alternative ID
88009-00000



3M™ PELTOR™ Rechargeable
Battery, ACK081, 1 EA/Case

3M Stock
7100075380

Previous 3M Stock
XH001680541

UPC
07318640063730

Alternative ID
ACK081



**3M™ PELTOR™ Rechargeable
Battery ACK053 for Lite-Com
BRS Headsets, 1 EA/Case**

3M Stock
7100075338

Previous 3M Stock
XH001680608

UPC
07318640063846

Alternative ID
ACK053



3M™ PELTOR™ Adapters



3M™ 1100 Earplugs



**3M™ Scotchlite™ Reflective
Material 9925, Silver Industrial
Wash Fabric, Roll, Config**

3M Stock
7100121735

Alternative ID
9925



**3M™ Scotchlite™ Reflective
Material 8940 Series**



**3M™ Protecta® Web Tie-Off
Adapter Anchor**



**Peltor™ Sport SecureFit™
Safety Eyewear SF400-PA-9,
Amber/AF Lens**

3M Stock
CBGBLRUS1538
UPC
00638060267226



**3M™ Anti-Fog Goggle with
Scotchgard™ Protector
47210H1-VDC-PS, Black/Blue,
Clear Lens, 5/cs**

3M Stock
CBGNAWUS1877
UPC
00638060280768



**ACE™ Brand Compression
Knee Sleeve with Pad**

3M Stock
CBGBLRUS1498
UPC
00051131194106



**3M™ Hard Hat with Ratchet
Adjustment White**

3M Stock
CBGNAW011112
UPC
00078371912970



**FUTURO™ Trouser Socks for
Women, Mild Compression**

3M Stock
CBGBLW011015
UPC
00051131201491



**FUTURO™ Business Casual
Socks for Men, Pattern**

3M Stock
CBGBLRUS1534
UPC
00051131215085



3M™ SecureFit™ 400
Indoor/Outdoor Eye Protection
SF400M-WV-6-PS, Mirror, Anti-
Scratch

3M Stock
CBGNARUS2462
UPC
00076308724023



Peltor™ Sport Blasts™ Corded
Disposable Earplugs
97081-10C, 2 Pair Pack, Neon
Yellow

3M Stock
CBGNAR2366
UPC
00078371970819



3M™ Folding Earmuff,
90563H1-DC, Black, 5
earmuff/case

3M Stock
CBGNAW011215
UPC
00076308906443



3M™ Performance Particulate
Respirator 8210

3M Stock
CBGNAW011086
UPC
0005111112205



3M™ Versaflo™ TR-300+ Series
PAPR Systems



3M™ DBI-SALA® Confined
Space Aluminum Tripod with
3-Way SRL 8301098, 50 ft. (15.2
m) Galvanized Cable

3M Stock
7100327878
UPC
00648250257852
Alternative ID
8301098



3M™ DBI-SALA® Confined Space Aluminum Tripod with 3-Way SRL 8301090, 7 ft Tripod,

50 ft Galvanized Cable

3M Stock
7100327871

UPC
00648250257777

Alternative ID
8301090



3M™ DBI-SALA® Confined Space Aluminum Tripod with 3-Way SRL 8301089, 7 ft Tripod, 50 ft Stainless Steel Cable

3M Stock
7100327870

UPC
00648250257760

Alternative ID
8301089



3M™ DBI-SALA® Confined Space Aluminum Tripod with 3-Way SRL 8301091, 7 ft Tripod, 50 ft Galvanized Cable

3M Stock
7100327872

UPC
00648250257784

Alternative ID
8301091



3M™ DBI-SALA® Confined Space Aluminum Tripod with 3-Way SRL 8301094, 9 ft Tripod, 50 ft Stainless Steel Cable

3M Stock
7100327874

UPC
00648250257814

Alternative ID
8301094



3M™ DBI-SALA® Confined Space Aluminum Tripod with 3-Way SRL 8301097, 9 ft Tripod, 50 ft Galvanized Cable

3M Stock
7100327877

UPC
00648250257845

Alternative ID
8301097



3M™ DBI-SALA® Lineman Belts



3M™ Health, Safety and Compliance Software Implementation, Pro

3M Stock
6100003506
Previous 3M Stock
70999987251
Alternative ID
SIM-TRN-PRO



3M™ Health, Safety and Compliance Software Implementation, Classic

3M Stock
6100003505
Previous 3M Stock
9000085
Alternative ID
SIM-TRN-CLASSIC



3M™ PELTOR™ Remote Control Unit RCU-300N/A, 1 ea/Case

3M Stock
7100223515
UPC
07318640070691
Alternative ID
RCU-300NA/1



3M™ E-A-R™ Skull Screws™ Metal Detectable Communication Ear Tips

3M Stock
7100158983
Alternative ID
MSC-YLM-25



3M™ SecureFit™ Protective Eyewear SF415AF, Clear Lens, +1.5 Diopter, 20 EA/Case

3M Stock
7100115326
Previous 3M Stock
70071695376
UPC
10078371665125
Alternative ID
SF415AF



3M™ SecureFit™ Protective Eyewear SF420AF, Clear Lens, +2.0 Diopter, 20 EA/Case

3M Stock
7100115325
Previous 3M Stock
70071695384
UPC
10078371665132
Alternative ID
SF420AF



3M™ SecureFit™ Protective Eyewear SF425AF, Clear Lens, +2.5 Diopter, 20 EA/Case

3M Stock
7100115329
Previous 3M Stock
70071695392
UPC
10078371665149
Alternative ID
SF425AF



3M™ Kids Hearing Protection Plus PKIDSP-TEAL, Teal, 4 ea/case

3M Stock
CBGNAWUS1884
UPC
00638060661772



FUTURO™ Pattern Tights

3M Stock
CBGBLRUS1516
UPC
00051131215047



Peltor™ Sport Tactical 300 Electronic Hearing Protector, TAC300-OTH, 1 Hearing Protector, 4/Case

3M Stock
CBGNARUS2570
UPC
00076308913571



3M™ SecureFit™ Hard Hat H-700 Series



3M™ Cool Flow™ Valve Particulate Respirator 8577 for Paint Odor

3M Stock
CBGNAW011201
UPC
00051131997660



3M™ Performance Reusable Paint Project Respirator OV/P95, 6211P1-DC, Size Medium, 1 each/pack, 4 packs/case
 3M Stock
 CBGNAW011142
 UPC
 00051138542511



3M™ DBI-SALA® ExoFit™ X200 Safety Harness



3M™ Hi-Viz Construction Vest Yellow
 3M Stock
 CBGNAW011090
 UPC
 10078371946170



3M™ Corded Reusable Earplug
 3M Stock
 CBGNAW011071
 UPC
 00076308147488



3M™ Scott™ Spares and Accessories
 3M Stock
 B5005270006



FUTURO™ Ultra Sheer Knee Highs for Women, Mild Compression
 3M Stock
 CBGBLW011016
 UPC
 00051131201132



3M™ Fit Test Solution



3M™ DBI-SALA® FlexiGuard™ M200 Permanent Mount Base



**3M™ Safety and Inspection
Manager, Emergency Services,
Silver**

3M Stock
6100003149

Previous 3M Stock
70999987194

Alternative ID
SIM-ES Silver



**3M™ Safety and Inspection
Manager, Emergency Services,
Custom**

3M Stock
6100003151

Previous 3M Stock
70999987210

Alternative ID
SIM-ES Custom



**3M™ Safety and Inspection
Manager, Emergency Services,
Gold**

3M Stock
6100003150

Previous 3M Stock
70999987202

Alternative ID
SIM-ES Gold



**3M™ Safety and Inspection
Manager, Emergency Services,
Bronze**

3M Stock
6100003148

Previous 3M Stock
70999987186

Alternative ID
SIM-ES Bronze



3M™ Safety and Inspection Manager for Emergency Service, Any Level, for Restricted

Customers
3M Stock
6100003704
Previous 3M Stock
70999987285
Alternative ID
SIM-ES Restricted



3M™ DBI-SALA® Adjustable Wristband with Retractor and Trigger Snap 1500087, 10/Pack

3M Stock
7100230429
Previous 3M Stock
1500087
UPC
00852684933156
Alternative ID
1500087



3M™ Adjustable Hook and Loop Wristband with Retractor 1500086, 1.5 lb Capacity, Universal

3M Stock
7100243791
UPC
00852684933125
Alternative ID
1500086



3M™ Snapcap Headband Assembly W-3257, 1 EA/Case

3M Stock
7000131001
Previous 3M Stock
78806027815
UPC
00051138215606
Alternative ID
W-3257



3M™ Versaflo™ Headband for Premium Head Suspension S-951 1 EA/Case

3M Stock
7000127436
Previous 3M Stock
70071533403
UPC
00051131171022
Alternative ID
S-951



3M™ DBI-SALA® Flexiguard™ M100 Modular Jib Outrigger Base 8530873

3M Stock
7100252864
UPC
00648250177037
Alternative ID
8530873



3M™ Welding Breathing Tubes



3M™ DBI-SALA® Fall Protection
for Tools Belts



3M™ SecureFit™ 500 Series
Safety Glasses



3M™ Tinted Lens Cover 7986,
Accessory 25 EA/BAG

3M Stock
7000126281
Previous 3M Stock
70070799427
UPC
50051138661880
Alternative ID
7986



3M™ Stacked Lens Cover
FF-400-18, 20 EA/Case

3M Stock
7010385198
Previous 3M Stock
70071674736
UPC
50051141567889
Alternative ID
FF-400-18



3M™ Lens Cover
7899-25/7899-25-AM, Accessory
25 EA/Case

3M Stock
7000125981
Previous 3M Stock
70070080935
UPC
50021200604176
Alternative ID
7899-25/7899-25-
AM



**3M™ Speedglas™ G5-02
Welding Helmet 08-0100-50iC,
with Curved ADF, Headband,
Cleaning Wipe and Bag, 1
ea/Case**

3M Stock
7100239917
UPC
00076308944490

Alternative ID
08-0100-50iC



**3M™ Versaflo™ Peel-Off Visor
Cover, S-920L, Medium/Large,
for Integrated Suspension
Products, 40 ea/Bag**

3M Stock
7000127434
Previous 3M Stock
70071533353

UPC
50051131170990
Alternative ID
S-920L



**3M™ DBI-SALA® Nano-Lok™
Edge Twin-Leg Personal Self
Retracting Lifeline 3500279,
Cable, Steel Snap Hook, 8 ft.,
Class 2, ...**

3M Stock
7012819225
UPC
00648250243473

Alternative ID
3500279



**3M™ Versaflo™ Peel-Off Visor
Cover S-922, for S-600 S-700
and S-800 Assemblies 40
EA/Case**

3M Stock
7100138630
Previous 3M Stock
70071533379

UPC
50051131373025
Alternative ID
S-922



**3M™ Versaflo™ Tinted Peel-Off
Covers M-924, for M-927
Premium Visor, 25 ea/Case**

3M Stock
7100288242
UPC
50638060434586

Alternative ID
M-924



**3M™ Scott™ AV-3000 SS/HT
Clear Peel Off 201839-11,
25/Pack**

3M Stock
70002009911
Alternative ID
201839-11



**3M™ Versaflo™ Multi Layer
Peel-Off Visor Cover, S-923-10,
for S-600 S-700 and S-800
Assemblies 10 EA/Case**

3M Stock
7010316605
UPC
00051141567136
Alternative ID
S-923-10

**3M™ Versaflo™ Multi Layer
Peel-Off Visor Cover, S-923-50,
for S-600 S-700 and S-800
Assemblies 50 EA/Case**

3M Stock
7010385074
Previous 3M Stock
70071673175
UPC
50051141567124
Alternative ID
S-923-50

**3M™ Versaflo™ Tinted Peel-Off
Covers M-923-25, for M-925
Standard Visor, 25 ea/Case**

3M Stock
7100286571
UPC
50076308401172
Alternative ID
M-923



**3M™ Scott™ AV-3000 SS/HT
Transparent Peel Off 201839-22,
25/Pack**

3M Stock
70002009903
Alternative ID
201839-22

**3M™ DBI-SALA® Rollgliss™
R550 Oil and Gas Rescue and
Descent Device Kit with Rescue
Wheel 3300005, Kernmantle
Rope, 200 ft**

3M Stock
7100231777
UPC
00840779188741
Alternative ID
3300005

**3M™ Speedglas™ G5-03 Pro-
Air Welding Helmet with 3M™
V-100 Vortex Cooling Valve
Assembly 45-5702-00, No ADF,
1 EA/Case**

3M Stock
7100311731
Previous 3M Stock
70100400244
UPC
00638060430712
Alternative ID
45-5702-00



3M™ Push-Ins™ Probed Test Plugs 393-2015-50, with Grip Rings, 50 EA/Case

3M Stock
7000148552
Previous 3M Stock
70071650298
UPC
10078371660397
Alternative ID
393-2015-50



3M™ E-A-Rfit™ EARCAPS Test Probe 393-2020, 50 Pair/Case

3M Stock
7100113020
Previous 3M Stock
70071674157
UPC
10078371667600



3M™ E-A-R™ Push-Ins™ Probed Test Earplugs 393-2002-50, 50 Pair/Case

3M Stock
7000052881
Previous 3M Stock
70071562766
UPC
10080529190755
Alternative ID
393-2002-50



3M™ S-Series PAPR Hoods & Hood Assemblies



3M™ E-A-Rsoft™ Yellow Neon Blasts™ Earplugs



3M™ DBI-SALA® Confined Space Tripod Mounting Base Bracket For Winch/SRL 8005048

3M Stock
7100240881
UPC
00840779005659
Alternative ID
8005048



**3M™ E-A-R™ E-Z-Fit™ Probed
Test Plugs 393-2005-50, 50
EA/Case**

3M Stock
7000127699
Previous 3M Stock
70071562790
UPC
10080529190786
Alternative ID
393-2005-50



**3M™ E-A-R™ TaperFit™ 2
Large Probed Test Plugs
393-2027-50, 50 Pair/Case**

3M Stock
7100230133
UPC
50638060428950
Alternative ID
393-2027-50



**3M™ E-A-R™ TaperFit™ 2
Probed Test Plugs 393-2006-50,
50 EA/Case**

3M Stock
7000002388
Previous 3M Stock
70071562808
UPC
10080529190793
Alternative ID
393-2006-50



**3M™ SecureFit™ 3700 Series
Safety Glasses**



**3M™ PELTOR™ ComTac™ VI
Tactical Headsets**



**3M™ Speedglas™ Welding
Lens 9100, 06-0005-P10,
Passive Shade 10, 2 Ea/Case
(Replacement Lens Only)**

3M Stock
7010385032
UPC
00051141563183
Alternative ID
06-0005-P10



3M™ Speedglas™ Welding
Lens 9100, 06-0005-P12,
Passive Shade 12, 2 Ea/Case
(Replacement Lens Only)

3M Stock
7010385033

UPC
00051141563206

Alternative ID
06-0005-P12



3M™ Speedglas™ Welding
Lens 9100, 06-0005-P11,
Passive Shade 11, 2 Ea/Case
(Replacement Lens Only)

3M Stock
7010316592

UPC
00051141563190

Alternative ID
06-0005-P11



3M™ Speedglas™ Welding
Lens 9100, 06-0005-P13,
Passive Shade 13, 2 Ea/Case
(Replacement Lens Only)

3M Stock
7010342412

UPC
00051141563534

Alternative ID
06-0005-P13



3M™ DBI-SALA®
Rebar/Positioning Lanyard



3M™ Scotchlite™ Reflective
Material 9186, Fluorescent Red-
Orange Industrial Wash Flame
Resistant Trim, 76.2 mm x 100
m, 4...

3M Stock
7010391763

UPC
00051131171053

Alternative ID
9186



3M™ DBI-SALA® Nano-Lok™
Extended Length Self-Retracting
Lifelines



3M™ Scotchlite™ Reflective Material 9687 Series



3M™ PELTOR™ System Control Unit SCU-300NA WS GE, Gray, 20 ea/Case

3M Stock
7100223396

UPC
07318640070677

Alternative ID
SCU-300NA WS GE



3M™ PELTOR™ System Control Unit SCU-300NA CY, Brown, 20 ea/Case

3M Stock
7100224665

UPC
07318640070660

Alternative ID
SCU-300NA CY



3M™ DBI-SALA® ShockWave™ Shock Absorbing Lanyard



3M™ Scott™ Vision C5 Facepiece with Radio Direct Interface

3M Stock
B5005289010



3M™ SecureFit™ Safety Glasses SF615SGAF, Clear Scotchgard™ Anti-fog Lens +1.5 Diopter, 20 EA/Case

3M Stock
7100132357

Previous 3M Stock
70071696168

UPC
50051131273479

Alternative ID
SF615SGAF



**3M™ SecureFit™ SF625SGAF,
Clear Scotchgard™ Anti-fog lens
+2.5 Diopter, 20 ea/case**

3M Stock
7100132360
Previous 3M Stock
70071696184
UPC
50051131273493
Alternative ID
SF625SGAF



**3M™ SecureFit™ SF620SGAF,
Clear Scotchgard™ Anti-fog
Lens +2.0 Diopter, 20 ea/case**

3M Stock
7100132359
Previous 3M Stock
70071696176
UPC
50051131273486
Alternative ID
SF620SGAF



**3M™ DBI-SALA® EZ-Stop™
Shock Absorbing Lanyard**



**3M™ Scott™ EZ-Scape Pro
Integrated Self-Rescue Belt**

3M Stock
B5005047171



**3M™ SecureFit™ Full Brim Hard
Hat H-800**



**3M™ Scott™ Air-Pak™ 75
SCBA**

3M Stock
B5005047161



**3M™ Scott™ AV-3000 SureSeal
Facepiece**

3M Stock
B5005047143



**3M™ DBI-SALA® ExoFit™
X300 Safety Harness**



3M™ Scott™ Vision C5
Facepiece with E-Z Flo C5
Regulator

3M Stock
B5005270009



3M™ E-A-Rsoft™ Grippers
Probed Test Plugs 393-2021-50,
50 Pair/Case

3M Stock
7010341317
Previous 3M Stock
70071674876
UPC
10078371670167
Alternative ID
393-2021-50



3M™ DBI-SALA® Lad-Saf™
Cable Vertical Safety System



3M™ Centurion™ 454 Series
Safety Impact Goggles



3M™ DBI-SALA® FlexiGuard™
M200 Portable Counterweight
Base



3M™ DBI-SALA® FlexiGuard™
M100 Adjustable Height Mast

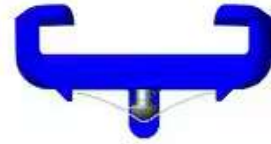

3M™ Versaflo™ Filter Latch
Assembly TR-651, for TR-600
PAPR

3M Stock
7100134950

Previous 3M Stock
70071622081

UPC
00051131373822

Alternative ID
TR-651



3M™ Versaflo™ Filter Latch
Assembly TR-851/94245(AAD),
for TR-800 PAPR 1EA

3M Stock
7100150941

UPC
00076308942458

Alternative ID
TR-851



3M™ Filter Housing Assembly
W-3094M 1 EA/Case

3M Stock
7010384897

Previous 3M Stock
70071401924

UPC
00051131985391

Alternative ID
W-3094M



3M™ DBI-SALA® ExoFit
STRATA™ Harness



**3M™ Speedglas™ Breathing
Tube Cover SG-15, 1 EA/Case**

3M Stock
7000128115

Previous 3M Stock
70071607975

UPC
00051131498709

Alternative ID
SG-15



**3M™ Fall Protection
Retrofittable Safety Harness
Accessories**



**3M™ DBI-SALA® Nano-Lok™
Single-Leg Connector 3100088,
Zinc Plated Steel**

3M Stock
7012776939

UPC
00840779012022

Alternative ID
3100088



**3M™ H-Series PPR Hoods &
Hood Assemblies**



**3M™ Double Locking Rebar
Snap Hook 9502058, Aluminum,
3600 lb Gate, 2 1/4 in Throat**

3M Stock
7012821265

Previous 3M Stock
9502058

Alternative ID
9502058



3M™ Scott™ X3-21 Pro SCBA

3M Stock
B5005341004

Alternative ID
X3-21 Pro



**3M™ PELTOR™ CH-3 Listen
Only Hearing Protector
HT52B-112, Neckband, 1
ea/Case**

3M Stock
7100203298
Alternative ID
HT52B-112



**3M™ PELTOR™ CH-3 Listen
Only Hearing Protector
HT52P3E-112, Hard Hat
Attached, 1 ea/Case**

3M Stock
7100203302
UPC
04054596695535
Alternative ID
HT52P3E-112



**3M™ PELTOR™ CH-3 Listen
Only Hearing Protector
HT52A-112, Headband, 1
ea/Case**

3M Stock
7100203299
Alternative ID
HT52A-112



**3M™ Scott™ AV-632 Bayonet
Adapter**

3M Stock
B5005285023



**3M™ Goggle Gear, 500-Series,
GG501SGAF-LENS, Clear
Scotchgard™ Anti-fog
Replacement Lens, 20 ea/Case**

3M Stock
7100222787
UPC
50051131279341
Alternative ID
GG501SGAF-LENS



**3M™ E-A-Rfit™ Mic Clips
073-100 , 10/Each**

3M Stock
7100105873
Previous 3M Stock
70071676160
UPC
00051131275447



**3M™ E-A-R™ Classic™ Plus
Probed Test Plugs 393-2009-50,
50 EA/Case**
3M Stock
7000052880
Previous 3M Stock
70071562733
UPC
10080529190823
Alternative ID
393-2009-50



**3M™ E-A-R™ EXPRESS™ Pod
Plugs™ Probed Test Plugs
393-2008-50, 50 PR/Case**
3M Stock
7000052879
Previous 3M Stock
70071562725
UPC
10080529190816
Alternative ID
393-2008-50



**3M™ SecureFit™ Safety Helmet
Replacement Suspension
Systems**



**3M™ Adflo™ Turbo Assembly
Without Belt and Breathing
Tube, 35-1499-01, 1 EA/CASE**
3M Stock
7100200534
UPC
00076308943233
Alternative ID
35-1499-01



**3M™ Adflo™ Turbo Assembly
35-5401-01, Lithium Ion Battery,
1 EA/CASE**
3M Stock
7100200529
UPC
00076308943257
Alternative ID
35-5401-01



**3M™ GoggleGear™ 500 Series
Safety Goggles**



3M™ DBI-SALA® Leading Edge Tripod Anchor For Concrete
2190074

3M Stock
7012818380

Previous 3M Stock
2190074

UPC
00840779162130

Alternative ID
2190074



3M™ Scott™ Mobile Air Cart

3M Stock
B5005047154



3M™ Dual Cartridge Respirator Packout 07178, Organic Vapor/P95, Medium

3M Stock
7000002067

Previous 3M Stock
70070797751

UPC
00051131071780

Alternative ID
07178



3M™ DBI-SALA® Confined Space Davit Arm 8516693, 1 EA

3M Stock
7100188843

UPC
00648250165287

Alternative ID
8516693



3M™ Replacement Cartridges for Multi-purpose Respirator, 60923H1-DC, 1 pair/pack, 5 packs/case

3M Stock
70006983319

UPC
00051141900223



**3M™ HARD HAT
VENTED CAP STYLE**

3M™ Vented Hard Hat CHHWH1-V-12-DC, with PinLock Adjustment, White, 12/Case

3M Stock
V101514144

UPC
00051131226715



**3M™ HARD HAT
VENTED CAP STYLE**

**3M™ Vented Hard Hat
CHHYH1-V-12-DC, with Pinlock
Adjustment, Yellow, 12/case**

3M Stock
V101514145

UPC
00051131226722



**3M™ PELTOR™ Left Side
Boom Harness, NATO Wiring,
FL6AF, 10 EA/Case**

3M Stock
7000141070

Previous 3M Stock
XH001652003

UPC
07318640037953

Alternative ID
FL6AF



**3M™ PELTOR™ Left Side
Boom Harness FL6AR 1
EA/Case**

3M Stock
7000141071

Previous 3M Stock
XH001652011

UPC
04046719411337

Alternative ID
FL6AR



3M™ Sensitivity Solution



**3M™ DBI-SALA® FlexiGuard™
M100 Portable Counterweight
Base**



**3M™ Filter/Adapter/Retainer Kit
6N01, N95, 1 Kit/Case**

3M Stock
7100234543

UPC
00638060431412

Alternative ID
6N01



3M™ Disposable Protective Coverall 4540



3M™ PELTOR™ LiteCom Pro II Li-Ion Intrinsic Safe Battery ACK08-50, 1 EA/Case

3M Stock
7000108520

Previous 3M Stock
XH001680186

UPC
07318640063037

Alternative ID
ACK08-50



3M™ DBI-SALA® Temporary Horizontal Lifeline System For Vacuum Anchor System 2200400, Kernmantle Rope, 40 ft

3M Stock
7100235923

UPC
00840779001002

Alternative ID
2200400



3M™ DBI-SALA® Confined Space 5-Piece Davit Hoist System



3M™ DBI-SALA® Reusable Compact Roof Anchor For Wood 2104196, with Fastener Kit

3M Stock
7012818309

Previous 3M Stock
2104196

UPC
00840779149995

Alternative ID
2104196



3M™ DBI-SALA® Toggle Bolt Fastener Kit For Roof Top Anchor 7241183, 300 mm, 4 ea/Pack

3M Stock
7100241078

UPC
00840779013074

Alternative ID
7241183



**3M™ DBI-SALA® Toggle Bolt
Fastener Kit For Roof Top
Anchor 7241182, 150 mm, 4
ea/Pack**

3M Stock
7100241077

UPC
00840779013067

Alternative ID
7241182



**3M™ DBI-SALA® Permanent
Roof Anchor**



**3M™ PELTOR™ SwatTac V
Headset MT20H682BB-47 SV,
Neckband, Single Lead,
Standard Dynamic Mic, NATO
Wiring, Black, 10 ea/Case**

3M Stock
7100223422

UPC
00076308945947

Alternative ID
MT20H682BB-47
SV



**3M™ PELTOR™ SwatTac V
Headset MT20H682FB-19 SV,
Foldable, Dual Lead, Standard
Dynamic Mic, NATO Wiring,
Black, 10 ea/Case**

3M Stock
7100223425

UPC
00076308945916

Alternative ID
MT20H682FB-19 SV



**3M™ PELTOR™ SwatTac V
Headset MT20H682BB-19 SV,
Neckband, Dual Lead, Standard
Dynamic Mic, NATO Wiring,
Black, 10 ea/Case**

3M Stock
7100223439

UPC
00076308945886

Alternative ID
MT20H682BB-19
SV



**3M™ PELTOR™ SwatTac V
Hearing Defender Headset
MT20H682FB-09 SV, Foldable,
Black, 10 ea/Case**

3M Stock
7100223426

UPC
00076308946036

Alternative ID
MT20H682FB-09 SV



**3M™ PELTOR™ SwatTac V
Hearing Defender Headset
MT20H682BB-09 SV, Neckband,
Black, 10 ea/Case**

3M Stock
7100223429

UPC
00076308946005

Alternative ID
MT20H682BB-09
SV



**3M™ PELTOR™ SwatTac V
Headset MT20H682FB-47 SV,
Foldable, Single Lead, Standard
Dynamic Mic, NATO Wiring,
Black, 10 ea/Case**

3M Stock
7100223432

UPC
00076308945978

Alternative ID
MT20H682FB-47 SV



**3M™ SecureFit™ 300 Series
Safety Glasses**



**3M™ DBI-SALA® Lad-Saf™
Swaged Cable 6106110, 3/8
Inch, 7x19, Galvanized Steel,
110 FT**

3M Stock
7100184451

Previous 3M Stock
6106110

UPC
00840779165926

Alternative ID
6106110



**3M™ DBI-SALA® Lad-Saf™
Swaged Cable 6106130, 3/8
Inch, 7x19, Galvanized Steel,
130 FT**

3M Stock
7100184453

Previous 3M Stock
6106130

UPC
00840779165940

Alternative ID
6106130



**3M™ DBI-SALA® Lad-Saf™
Swaged Cable 6106120, 3/8
Inch, 7x19, Galvanized Steel,
120 FT**

3M Stock
7100184452

Previous 3M Stock
6106120

UPC
00840779165933

Alternative ID
6106120



**3M™ DBI-SALA® Lad-Saf™
Swaged Cable 6106170, 3/8
Inch, 7x19, Galvanized Steel,
170 FT**

3M Stock
7100184457

Previous 3M Stock
6106170

UPC
00840779165988

Alternative ID
6106170



**3M™ DBI-SALA® Lad-Saf™
Swaged Cable 6106160, 3/8
Inch, 7x19, Galvanized Steel,
160 FT**

3M Stock
7100184456

Previous 3M Stock
6106160

UPC
00840779165971

Alternative ID
6106160



**3M™ DBI-SALA® Lad-Saf™
Swaged Cable 6106150, 3/8
Inch, 7x19, Galvanized Steel,
150 FT**

3M Stock
7100184455

Alternative ID
6106150



**3M™ DBI-SALA® Lad-Saf™
Swaged Cable 6106140, 3/8
Inch, 7x19, Galvanized Steel,
140 FT**

3M Stock
7100184454

Previous 3M Stock
6106140

UPC
00840779165957

Alternative ID
6106140



**3M™ DBI-SALA® Lad-Saf™
Swaged Cable 6106220, 3/8
Inch, 7x19, Galvanized Steel,
220 FT**

3M Stock
7100184461

Previous 3M Stock
6106220

UPC
00840779166022

Alternative ID
6106220



**3M™ DBI-SALA® Lad-Saf™
Swaged Cable 6106190, 3/8
Inch, 7x19, Galvanized Steel,
190 FT**

3M Stock
7100184459

Previous 3M Stock
6106190

UPC
00840779166008

Alternative ID
6106190



3M™ DBI-SALA® Lad-Saf™
Swaged Cable 6104010, 3/8
Inch, 1x7, Galvanized Steel, 10
FT

3M Stock
7100184340

Previous 3M Stock
6104010

UPC
00840779152858

Alternative ID
6104010



3M™ DBI-SALA® Lad-Saf™
Swaged Cable 6106280, 3/8
Inch, 7x19, Galvanized Steel,
280 FT

3M Stock
7100184464

Previous 3M Stock
6106280

UPC
00840779166053

Alternative ID
6106280



3M™ DBI-SALA® Lad-Saf™
Swaged Cable 6104030, 3/8
Inch, 1x7, Galvanized Steel, 30
FT

3M Stock
7100184342

UPC
00840779152872

Alternative ID
6104030



3M™ DBI-SALA® Lad-Saf™
Swaged Cable 6106260, 3/8
Inch, 7x19, Galvanized Steel,
260 FT

3M Stock
7100184463

Previous 3M Stock
6106260

UPC
00840779166046

Alternative ID
6106260



3M™ DBI-SALA® Lad-Saf™
Swaged Cable 6104020, 3/8
Inch, 1x7, Galvanized Steel, 20
FT

3M Stock
7100184341

UPC
00840779152865

Alternative ID
6104020



3M™ DBI-SALA® Lad-Saf™
Swaged Cable 6107035, 3/8
Inch, 7x19, Stainless Steel, 35
FT

3M Stock
7100184468

Previous 3M Stock
6107035

UPC
00840779166091

Alternative ID
6107035



3M™ DBI-SALA® Lad-Saf™
Swaged Cable 6105020, 3/8
Inch, 1x7, Stainless Steel, 20 FT

3M Stock
7100184346
UPC
00840779152919
Alternative ID
6105020



3M™ DBI-SALA® Lad-Saf™
Swaged Cable 6107025, 3/8
Inch, 7x19, Stainless Steel, 25
FT

3M Stock
7100184467
Previous 3M Stock
6107025
UPC
00840779166084
Alternative ID
6107025



3M™ DBI-SALA® Lad-Saf™
Swaged Cable 6107015, 3/8
Inch, 7x19, Stainless Steel, 15
FT

3M Stock
7100184466
Previous 3M Stock
6107015
UPC
00840779166077
Alternative ID
6107015



3M™ DBI-SALA® Lad-Saf™
Swaged Cable 6104050, 3/8
Inch, 1x7, Galvanized Steel, 50
FT

3M Stock
7100184344
UPC
00840779152896
Alternative ID
6104050



3M™ DBI-SALA® Lad-Saf™
Swaged Cable 6106300, 3/8
Inch, 7x19, Galvanized Steel,
300 FT

3M Stock
7100184465
Previous 3M Stock
6106300
UPC
00840779166060
Alternative ID
6106300



3M™ DBI-SALA® Lad-Saf™
Swaged Cable 6104040, 3/8
Inch, 1x7, Galvanized Steel, 40
FT

3M Stock
7100184343
UPC
00840779152889
Alternative ID
6104040



3M™ Speedglas™ 100 Series
Welding Helmets



3M™ DBI-SALA® Lad-Saf™
Swaged Cable 6107055, 3/8
Inch, 7x19, Stainless Steel, 55
FT

3M Stock
7100184470
UPC
00840779166114
Alternative ID
6107055



3M™ DBI-SALA® Lad-Saf™
Swaged Cable 6105040, 3/8
Inch, 1x7, Stainless Steel, 40 FT

3M Stock
7100184348
UPC
00840779152933
Alternative ID
6105040



3M™ DBI-SALA® Lad-Saf™
Swaged Cable 6107045, 3/8
Inch, 7x19, Stainless Steel, 45
FT

3M Stock
7100184469
Previous 3M Stock
6107045
UPC
00840779166107
Alternative ID
6107045



3M™ Speedglas™ 9100 FX-Air
Welding Helmet
26-0099-35SW/37266(AAD),
with SideWindows and Extended
Headcover, No ADF, 1 EA/...

3M Stock
7100062095
Previous 3M Stock
70071668779
Alternative ID
26-0099-35SW/37266(AAD)



3M™ DBI-SALA® Lad-Saf™
Swaged Cable 6107080, 3/8
Inch, 7x19, Stainless Steel, 80
FT

3M Stock
7100184475
Previous 3M Stock
6107080
UPC
00840779166169
Alternative ID
6107080



**3M™ DBI-SALA® Lad-Saf™
Swaged Cable 6106040, 3/8
Inch, 7x19, Galvanized Steel, 40
FT**

3M Stock
7100184353

UPC
00840779152988

Alternative ID
6106040



**3M™ DBI-SALA® Lad-Saf™
Swaged Cable 6107075, 3/8
Inch, 7x19, Stainless Steel, 75
FT**

3M Stock
7100184474

Previous 3M Stock
6107075

UPC
00840779166152

Alternative ID
6107075



**3M™ DBI-SALA® Lad-Saf™
Swaged Cable 6106030, 3/8
Inch, 7x19, Galvanized Steel, 30
FT**

3M Stock
7100184352

Alternative ID
6106030



**3M™ DBI-SALA® Lad-Saf™
Swaged Cable 6107070, 3/8
Inch, 7x19, Stainless Steel, 70
FT**

3M Stock
7100184473

UPC
00840779166145

Alternative ID
6107070



**3M™ DBI-SALA® Lad-Saf™
Swaged Cable 6106020, 3/8
Inch, 7x19, Galvanized Steel, 20
FT**

3M Stock
7100184351

UPC
00840779152964

Alternative ID
6106020



**3M™ DBI-SALA® Lad-Saf™
Swaged Cable 6107065, 3/8
Inch, 7x19, Stainless Steel, 65
FT**

3M Stock
7100184472

Previous 3M Stock
6107065

UPC
00840779166138

Alternative ID
6107065



**3M™ DBI-SALA® Lad-Saf™
Swaged Cable 6107100, 3/8
Inch, 7x19, Stainless Steel, 100
FT**

3M Stock
7100184479

UPC
00840779166206

Alternative ID
6107100



**3M™ DBI-SALA® Lad-Saf™
Swaged Cable 6107020, 3/8
Inch, 7x19, Stainless Steel, 20
FT**

3M Stock
7100184356

Previous 3M Stock
6107020

UPC
00840779153015

Alternative ID
6107020



**3M™ DBI-SALA® Lad-Saf™
Swaged Cable 6107090, 3/8
Inch, 7x19, Stainless Steel, 90
FT**

3M Stock
7100184477

Previous 3M Stock
6107090

UPC
00840779166183

Alternative ID
6107090



**3M™ DBI-SALA® Lad-Saf™
Swaged Cable 6107010, 3/8
Inch, 7x19, Stainless Steel, 10
FT**

3M Stock
7100184355

Previous 3M Stock
6107010

UPC
00840779153008

Alternative ID
6107010



**3M™ DBI-SALA® Lad-Saf™
Swaged Cable 6107085, 3/8
Inch, 7x19, Stainless Steel, 85
FT**

3M Stock
7100184476

Previous 3M Stock
6107085

UPC
00840779166176

Alternative ID
6107085



**3M™ DBI-SALA® Lad-Saf™
Swaged Cable 6107120, 3/8
Inch, 7x19, Stainless Steel, 120
FT**

3M Stock
7100184481

Previous 3M Stock
6107120

UPC
00840779166220

Alternative ID
6107120



**3M™ DBI-SALA® Lad-Saf™
Swaged Cable 6107110, 3/8
Inch, 7x19, Stainless Steel, 110
FT**

3M Stock
7100184480
Previous 3M Stock
6107110
UPC
00840779166213
Alternative ID
6107110



**3M™ DBI-SALA® Lad-Saf™
Swaged Cable 6107040, 3/8
Inch, 7x19, Stainless Steel, 40
FT**

3M Stock
7100184358
UPC
00840779153039
Alternative ID
6107040



**3M™ DBI-SALA® Lad-Saf™
Swaged Cable 6107130, 3/8
Inch, 7x19, Stainless Steel, 130
FT**

3M Stock
7100184482
Previous 3M Stock
6107130
UPC
00840779166237
Alternative ID
6107130



**3M™ DBI-SALA® Lad-Saf™
Swaged Cable 6107170, 3/8
Inch, 7x19, Stainless Steel, 170
FT**

3M Stock
7100184486
Previous 3M Stock
6107170
UPC
00840779166275
Alternative ID
6107170



**3M™ DBI-SALA® Lad-Saf™
Swaged Cable 6104100, 3/8
Inch, 1x7, Galvanized Steel, 100
FT**

3M Stock
7100184364
UPC
00840779163632
Alternative ID
6104100



**3M™ DBI-SALA® Lad-Saf™
Swaged Cable 6107140, 3/8
Inch, 7x19, Stainless Steel, 140
FT**

3M Stock
7100184483
Previous 3M Stock
6107140
UPC
00840779166244
Alternative ID
6107140



3M™ DBI-SALA® Lad-Saf™
Swaged Cable 6105090, 3/8
Inch, 1x7, Stainless Steel, 90 FT

3M Stock
7100184368
Previous 3M Stock
6105090
UPC
00840779163670
Alternative ID
6105090



3M™ DBI-SALA® Lad-Saf™
Swaged Cable 6107200, 3/8
Inch, 7x19, Stainless Steel, 200
FT

3M Stock
7100184489
Previous 3M Stock
6107200
UPC
00840779166305
Alternative ID
6107200



3M™ DBI-SALA® Lad-Saf™
Swaged Cable 6107190, 3/8
Inch, 7x19, Stainless Steel, 190
FT

3M Stock
7100184488
Previous 3M Stock
6107190
UPC
00840779166299
Alternative ID
6107190



3M™ DBI-SALA® Lad-Saf™
Swaged Cable 6105070, 3/8
Inch, 1x7, Stainless Steel, 70 FT

3M Stock
7100184366
UPC
00840779163656
Alternative ID
6105070



3M™ DBI-SALA® Lad-Saf™
Swaged Cable 6107180, 3/8
Inch, 7x19, Stainless Steel, 180
FT

3M Stock
7100184487
Previous 3M Stock
6107180
UPC
00840779166282
Alternative ID
6107180



3M™ DBI-SALA® Lad-Saf™
Swaged Cable 6105060, 3/8
Inch, 1x7, Stainless Steel, 60 FT

3M Stock
7100184365
UPC
00840779163649
Alternative ID
6105060



3M™ DBI-SALA® Lad-Saf™
Swaged Cable 6105100, 3/8
Inch, 1x7, Stainless Steel, 100
FT

3M Stock
7100184369
Previous 3M Stock
6105100
UPC
00840779163687
Alternative ID
6105100



3M™ DBI-SALA® Lad-Saf™
Swaged Cable 6105280, 3/8
Inch, 1x7, Stainless Steel, 280
FT

3M Stock
7100184435
UPC
00840779165766
Alternative ID
6105280



3M™ DBI-SALA® Lad-Saf™
Swaged Cable 6105240, 3/8
Inch, 1x7, Stainless Steel, 240
FT

3M Stock
7100184433
Previous 3M Stock
6105240
UPC
00840779165742
Alternative ID
6105240



3M™ DBI-SALA® Lad-Saf™
Swaged Cable 6105220, 3/8
Inch, 1x7, Stainless Steel, 220
FT

3M Stock
7100184432
Previous 3M Stock
6105220
UPC
00840779165735
Alternative ID
6105220



3M™ DBI-SALA® Lad-Saf™
Swaged Cable 6106035, 3/8
Inch, 7x19, Galvanized Steel, 35
FT

3M Stock
7100184439
UPC
00840779165803
Alternative ID
6106035



3M™ DBI-SALA® Lad-Saf™
Swaged Cable 6106025, 3/8
Inch, 7x19, Galvanized Steel, 25
FT

3M Stock
7100184438
UPC
00840779165797
Alternative ID
6106025



**3M™ DBI-SALA® Lad-Saf™
Swaged Cable 6106015, 3/8
Inch, 7x19, Galvanized Steel, 15
FT**

3M Stock
7100184437

UPC
00840779165780

Alternative ID
6106015



**3M™ DBI-SALA® Lad-Saf™
Swaged Cable 6106055, 3/8
Inch, 7x19, Galvanized Steel, 55
FT**

3M Stock
7100184441

Previous 3M Stock
6106055

UPC
00840779165827

Alternative ID
6106055



**3M™ DBI-SALA® Lad-Saf™
Swaged Cable 6106060, 3/8
Inch, 7x19, Galvanized Steel, 60
FT**

3M Stock
7100184442

UPC
00840779165834

Alternative ID
6106060



**3M™ DBI-SALA® Lad-Saf™
Swaged Cable 6106080, 3/8
Inch, 7x19, Galvanized Steel, 80
FT**

3M Stock
7100184446

UPC
00840779165872

Alternative ID
6106080



**3M™ DBI-SALA® Lad-Saf™
Swaged Cable 6106075, 3/8
Inch, 7x19, Galvanized Steel, 75
FT**

3M Stock
7100184445

Previous 3M Stock
6106075

UPC
00840779165865

Alternative ID
6106075



**3M™ DBI-SALA® Lad-Saf™
Swaged Cable 6106070, 3/8
Inch, 7x19, Galvanized Steel, 70
FT**

3M Stock
7100184444

UPC
00840779165858

Alternative ID
6106070



3M™ DBI-SALA® Lad-Saf™
Swaged Cable 6106065, 3/8
Inch, 7x19, Galvanized Steel, 65
FT

3M Stock
7100184443
Previous 3M Stock
6106065
UPC
00840779165841
Alternative ID
6106065



3M™ DBI-SALA® Lad-Saf™
Swaged Cable 6106100, 3/8
Inch, 7x19, Galvanized Steel,
100 FT

3M Stock
7100184450
UPC
00840779165919
Alternative ID
6106100



3M™ DBI-SALA® Lad-Saf™
Swaged Cable 6106095, 3/8
Inch, 7x19, Galvanized Steel, 95
FT

3M Stock
7100184449
Previous 3M Stock
6106095
UPC
00840779165902
Alternative ID
6106095



3M™ DBI-SALA® Lad-Saf™
Swaged Cable 6106090, 3/8
Inch, 7x19, Galvanized Steel, 90
FT

3M Stock
7100184448
Previous 3M Stock
6106090
UPC
00840779165896
Alternative ID
6106090



3M™ DBI-SALA® Lad-Saf™
Swaged Cable 6104300, 3/8
Inch, 1x7, Galvanized Steel, 300
FT

3M Stock
7100184412
UPC
00840779165537
Alternative ID
6104300



3M™ DBI-SALA® Lad-Saf™
Swaged Cable 6105025, 3/8
Inch, 1x7, Stainless Steel, 25 FT

3M Stock
7100184414
UPC
00840779165551
Alternative ID
6105025



**3M™ DBI-SALA® Lad-Saf™
Swaged Cable 6105015, 3/8
Inch, 1x7, Stainless Steel, 15 FT**

3M Stock
7100184413

UPC
00840779165544

Alternative ID
6105015



**3M™ DBI-SALA® Lad-Saf™
Swaged Cable 6105065, 3/8
Inch, 1x7, Stainless Steel, 65 FT**

3M Stock
7100184418

Previous 3M Stock
6105065

UPC
00840779165599

Alternative ID
6105065



**3M™ DBI-SALA® Lad-Saf™
Swaged Cable 6105095, 3/8
Inch, 1x7, Stainless Steel, 95 FT**

3M Stock
7100184421

Previous 3M Stock
6105095

UPC
00840779165629

Alternative ID
6105095



**3M™ DBI-SALA® Lad-Saf™
Swaged Cable 6105120, 3/8
Inch, 1x7, Stainless Steel, 120
FT**

3M Stock
7100184423

Previous 3M Stock
6105120

UPC
00840779165643

Alternative ID
6105120



**3M™ DBI-SALA® Lad-Saf™
Swaged Cable 6105110, 3/8
Inch, 1x7, Stainless Steel, 110
FT**

3M Stock
7100184422

Previous 3M Stock
6105110

UPC
00840779165636

Alternative ID
6105110



**3M™ DBI-SALA® Lad-Saf™
Swaged Cable 6105150, 3/8
Inch, 1x7, Stainless Steel, 150
FT**

3M Stock
7100184426

UPC
00840779165674

Alternative ID
6105150



3M™ DBI-SALA® Lad-Saf™
Swaged Cable 6105140, 3/8
Inch, 1x7, Stainless Steel, 140
FT

3M Stock
7100184425
Previous 3M Stock
6105140
UPC
00840779165667
Alternative ID
6105140



3M™ DBI-SALA® Lad-Saf™
Swaged Cable 6105130, 3/8
Inch, 1x7, Stainless Steel, 130
FT

3M Stock
7100184424
Previous 3M Stock
6105130
UPC
00840779165650
Alternative ID
6105130



3M™ DBI-SALA® Lad-Saf™
Swaged Cable 6105200, 3/8
Inch, 1x7, Stainless Steel, 200
FT

3M Stock
7100184431
UPC
00840779165728
Alternative ID
6105200



3M™ DBI-SALA® Lad-Saf™
Swaged Cable 6105180, 3/8
Inch, 1x7, Stainless Steel, 180
FT

3M Stock
7100184429
UPC
00840779165704
Alternative ID
6105180



3M™ DBI-SALA® Lad-Saf™
Swaged Cable 6105170, 3/8
Inch, 1x7, Stainless Steel, 170
FT

3M Stock
7100184428
UPC
00840779165698
Alternative ID
6105170



3M™ DBI-SALA® Lad-Saf™
Swaged Cable 6104035, 3/8
Inch, 1x7, Galvanized Steel, 35
FT

3M Stock
7100184391
UPC
00840779165322
Alternative ID
6104035



3M™ DBI-SALA® Lad-Saf™
Swaged Cable 6104065, 3/8
Inch, 1x7, Galvanized Steel, 65
FT

3M Stock
7100184394

UPC
00840779165353

Alternative ID
6104065



3M™ DBI-SALA® Lad-Saf™
Swaged Cable 6104095, 3/8
Inch, 1x7, Galvanized Steel, 95
FT

3M Stock
7100184397

Previous 3M Stock
6104095

UPC
00840779165384

Alternative ID
6104095



3M™ DBI-SALA® Lad-Saf™
Swaged Cable 6104085, 3/8
Inch, 1x7, Galvanized Steel, 85
FT

3M Stock
7100184396

UPC
00840779165377

Alternative ID
6104085



3M™ DBI-SALA® Lad-Saf™
Swaged Cable 6104140, 3/8
Inch, 1x7, Galvanized Steel, 140
FT

3M Stock
7100184401

UPC
00840779165421

Alternative ID
6104140



3M™ DBI-SALA® Lad-Saf™
Swaged Cable 6104120, 3/8
Inch, 1x7, Galvanized Steel, 120
FT

3M Stock
7100184399

UPC
00840779165407

Alternative ID
6104120



3M™ DBI-SALA® Lad-Saf™
Swaged Cable 6104180, 3/8
Inch, 1x7, Galvanized Steel, 180
FT

3M Stock
7100184405

UPC
00840779165469

Alternative ID
6104180



3M™ DBI-SALA® Lad-Saf™
Swaged Cable 6104150, 3/8
Inch, 1x7, Galvanized Steel, 150
FT

3M Stock
7100184402
UPC
00840779165438
Alternative ID
6104150



3M™ DBI-SALA® Lad-Saf™
Swaged Cable 6104240, 3/8
Inch, 1x7, Galvanized Steel, 240
FT

3M Stock
7100184409
Previous 3M Stock
6104240
UPC
00840779165506
Alternative ID
6104240



3M™ DBI-SALA® Lad-Saf™
Swaged Cable 6104280, 3/8
Inch, 1x7, Galvanized Steel, 280
FT

3M Stock
7100184411
Previous 3M Stock
6104280
UPC
00840779165520
Alternative ID
6104280



3M™ DBI-SALA® Smart Lock
Self-Retracting Lifeline 3503879,
Stainless Steel Cable, 40 ft. (12
m)

3M Stock
7100307005
UPC
00648250239469
Alternative ID
3503879



3M™ DBI-SALA® Smart Lock
Self-Retracting Lifeline 3503801,
Stainless Steel Cable, Blue, 30
ft. (10m) 1 Ea/Case

3M Stock
7100204324
Previous 3M Stock
3503801
Alternative ID
3503801



3M™ DBI-SALA® Smart Lock
Self-Retracting Lifeline 3503872,
20 ft, Galvanized Cable, Class 1

3M Stock
7100306993
UPC
00648250239391
Alternative ID
3503872



**3M™ DBI-SALA® Smart Lock
Self-Retracting Lifeline 3503878,
50 ft, Galvanized Cable, Class 1**

3M Stock
7100306995
UPC
00648250239452
Alternative ID
3503878



**3M™ DBI-SALA® Smart Lock
Self-Retracting Lifeline 3503821,
Stainless Steel Cable, Blue, 35
ft. (11m)**

3M Stock
7100204326
UPC
00840779162741
Alternative ID
3503821



**3M™ DBI-SALA® Smart Lock
Self-Retracting Lifeline 3503823,
Stainless Steel Cable, Blue, 50
ft. (15m)**

3M Stock
7100204328
Previous 3M Stock
3503823
UPC
00840779162765
Alternative ID
3503823



**3M™ Speedglas™ SL Welding
Helmet Spatter Protector
05-0695-00, 1 EA/Case**

3M Stock
7100049368
Previous 3M Stock
70071534302
UPC
00051131172258
Alternative ID
05-0695-00



**3M™ Speedglas™ Flip-Up
Mechanism 27-0099-53, for
9100MP Welding Helmets, 1
EA/Case**

3M Stock
7000128224
Previous 3M Stock
70071621596
UPC
00051141558134
Alternative ID
27-0099-53

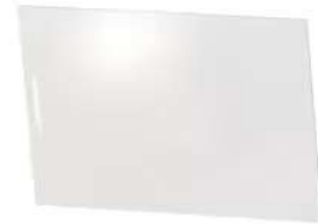

**3M™ Welding Inside Protection
Plates**



**3M™ Exhalation Valve Cover
7918, 20 EA/Case**

3M Stock
7000126043

Previous 3M Stock
70070408227

UPC
50051138290950

Alternative ID
7918



**3M™ Exhalation Valve Cover
FF-400-09, 5 EA/Case**

3M Stock
7000052740

Previous 3M Stock
70071516929

UPC
50051135894816

Alternative ID
FF-400-09



**3M™ Versaflo™ TR-300 Series
PAPR Filters**



**3M™ Adflo™ Blower Unit with
Cover, 35-1099-01, 1 EA/CASE**

3M Stock
7100200559

UPC
00076308943684

Alternative ID
35-1099-01



**3M™ Spark Arrestor TR-362, for
Versaflo™ TR-300+ PAPR 2
ea/Bag**

3M Stock
7000052905

Previous 3M Stock
70071563657

UPC
00051131173705

Alternative ID
TR-362



**3M™ Supplied Air Hoses &
Hose Assemblies**



3M™ VFlex™ Health Care Particulate Respirator & Surgical Mask 1800 Series



3M™ Headgear & Faceshield Combinations



3M™ PELTOR™ Optime™ 95 Folding Earmuffs H6F/V, Over-the-Head, 10 EA/Case

3M Stock
7000002328

Previous 3M Stock
70071517133

UPC
10093045080639

Alternative ID
H6F/V



3M™ Versaflo™ Replacement Forehead Seal M-354, for M-300 Series Hard Hats, 1 EA/Case

3M Stock
7000127680

Previous 3M Stock
70071562030

UPC
00051131173200

Alternative ID
M-354



3M™ Versaflo™ Replacement Forehead Seal M-154, for M-100 Series Face Shields, 1 EA/Case

3M Stock
7000127602

Previous 3M Stock
70071544962

UPC
00051131173149

Alternative ID
M-154



3M™ DBI-SALA® ExoFit NEX™ Lumbar Wear Pads For Wind Energy Harness Belt 9505504, Small/Medium

3M Stock
7012821699

Previous 3M Stock
9505504

Alternative ID
9505504



**3M™ DBI-SALA® Advanced™
Carrying Bag 8513330, 1 EA**

3M Stock
7100214247

UPC
00648250163122

Alternative ID
8513330



**3M™ DBI-SALA® Vacuum
Anchor Lifeline System
Compressed Air Cylinder
2200085**

3M Stock
7100280607

UPC
00648250182413

Alternative ID
2200085



**3M™ DBI-SALA®
SecuraSpan™ Rebar/Shear
Stud Horizontal Lifeline System
7400660, 1 EA**

3M Stock
B00036512

UPC
00840779005000



**3M™ DBI-SALA® Sealed-Blok™
Cable Assembly**



**3M™ DBI-SALA® Confined
Space Carrying Bag 8513329**

3M Stock
7100230446

Previous 3M Stock
8513329

UPC
00840779008827

Alternative ID
8513329



**3M™ DBI-SALA® Advanced™
Carrying Bag 8517567, 1 EA**

3M Stock
7100214171

UPC
00840779009022

Alternative ID
8517567



**3M™ Maxim™ Elite 1000 Series
Safety Glasses**



**3M™ DBI-SALA® Nano-Lok™
Self-Retracting Lifeline with
Anchor Hook**



**3M™ E-A-Rsoft™ Yellow
Neons™ Probed Test Plugs
393-2000-50, 50 EA/Case**

3M Stock
7100069736

Previous 3M Stock
70071562741

UPC
10080529190731

Alternative ID
393-2000-50



**3M™ Yellow Neons™ Test Plugs
393-2014-50, Large 50/Case**

3M Stock
7000148551

Previous 3M Stock
70071650249

UPC
10078371659490

Alternative ID
393-2014-50



**3M™ DBI-SALA® Sealed-Blok™
Assisted Rescue Pole/Tool for
RSQ Self-Retracting Lifeline
3500201, 6 - 12 ft**

3M Stock
7012819171

Alternative ID
3500201



**3M™ Virtua™ Reader Protective
Eyewear 11514-00000-20 Clear
Anti-Fog Lens, Clear Temple,
+2.0 Diopter 20 EA/Case**

3M Stock
7000127512

Previous 3M Stock
70071540044

UPC
10078371621206

Alternative ID
11514-00000-20



3M™ Virtua™ Reader Protective Eyewear 11513-00000-20 Clear Anti-Fog Lens, Clear Temple, +1.5 Diopter 20 EA/Case

3M Stock
7000127511
Previous 3M Stock
70071540036
UPC
10078371621190
Alternative ID
11513-00000-20



3M™ Virtua™ Reader Protective Eyewear 11515-00000-20 Clear Anti-Fog Lens, Clear Temple, +2.5 Diopter 20 EA/Case

3M Stock
7000127513
Previous 3M Stock
70071540051
UPC
10078371621213
Alternative ID
11515-00000-20



3M™ Probed Reusable Respirator Assembly 6100Q, Small 4 EA/Case

3M Stock
7000148501
Previous 3M Stock
70070317386
UPC
50051138289190
Alternative ID
6100Q



3M™ Protecta® Energy Absorbing Lanyards



3M™ DBI-SALA® Web D-ring Extension Anchor 1231117, Polyester, 1.5 ft

3M Stock
7012601516
UPC
00648250161708
Alternative ID
1231117

3M™ Probed Reusable Respirator Assembly 6300Q, Large 4 EA/Case

3M Stock
7000126031
Previous 3M Stock
70070317402
UPC
00051138289218
Alternative ID
6300Q



**3M™ DBI-SALA® Web D-ring
Extension Anchor 1231277,
Polyester, 1.4 ft**

3M Stock
7012817040
Previous 3M Stock
1231277
UPC
00840779041046
Alternative ID
1231277



**3M™ Solus™ Replacement
Strap, 10 ea/Bag**

3M Stock
7100085458
Previous 3M Stock
70071694569
Alternative ID
Solus-Strap



**3M™ Speedglas™ G5 Series
Auto Darkening Welding Filters**



**3M™ Speedglas™ Welding
Lens Assembly 9100, 06-0000-
P10, Passive Shade 10, 1/Case**

3M Stock
7010342411
UPC
00051141563176
Alternative ID
06-0000-P10



**3M™ SecureFit™ X5000 Series
Safety Helmets**



**3M™ SecureFit™ 201 Eyewear
Anti-Fog, SF201G1-DC, Gray,
Gray Lens, 4/case**

3M Stock
70006987914
UPC
00076308726447



**3M™ SecureFit™ 200 Eyewear
Anti-Fog, SF200G1-DC, Clear,
Clear Lens, 4/case**

3M Stock
70006987922

UPC
00076308726423



**3M™ SecureFit™ 200 Eyewear
Anti-Fog, SF200H1-DC, Clear,
Clear Lens, 6/case**

3M Stock
70006987997

UPC
00051141388854



**3M™ SecureFit™ 200 Eyewear
Anti-Fog, SF200P1-DC, Clear,
Clear Lens, 6/case**

3M Stock
70006988003

UPC
00051141388830



**3M™ Lead Paint Removal
Respirator, 62093H1-DC, 1
each/pack, 4 packs/case**

3M Stock
70006983350

UPC
00051141905204



**3M™ PELTOR™ UltraFit
Communication Tip
Replacement, Large, 25
EA/Case**

3M Stock
7100066388

Previous 3M Stock
70071673746

UPC
10093045937827

Alternative ID
370-TEPL-25



**3M™ PELTOR™ UltraFit
Communication Tip
Replacement, Small, 25
EA/Case**

3M Stock
7100066371

Previous 3M Stock
70071673720

UPC
10093045937803

Alternative ID
370-TEPS-25



**3M™ PELTOR™ UltraFit
Communication Tip**

Replacement, Medium, 25

EA/Case

3M Stock

7100066387

Previous 3M Stock

70071673738

UPC

10093045937810

Alternative ID

370-TEPM-25



**3M™ PELTOR™ UltraFit™
Replacement Tips**

420-2096-25A, Gray, 25 pr/cs

3M Stock

7000128143

Previous 3M Stock

70071612181

UPC

10093045935311

Alternative ID

420-2096-25A



**3M™ PELTOR™ Cup Mic
Windsock M60/2 1 EA/Case**

3M Stock

7000039650

Previous 3M Stock

XH001652532

UPC

04054596815636

Alternative ID

M60/2



**M40/1 WIND SHIELD FOR
DYNAMIC MICROPHONE
SMALL 1/CASE**

3M Stock

7000039648

Previous 3M Stock

XH001652516

UPC

07318640011700

Alternative ID

M40/1



**3M™ PELTOR™ Boom
Microphone Wind Screen, M995,
1 EA/CS**

3M Stock

7000127274

Previous 3M Stock

70071524527

UPC

00093045978786

Alternative ID

M995



**3M™ Peltor™ Wind Protector,
M171/2, 200 pair/Case**

3M Stock

7100112112

Alternative ID

M171/2



**3M™ PELTOR™ Boom
Microphone, MT73/1, 1 EA/CS**

3M Stock
7100112094

UPC
07318640067547

Alternative ID
MT73/1



**3M™ PELTOR™ Foam
Windscreen for TEP-100, TEP-
WINDSCREEN**

3M Stock
7100113748

Previous 3M Stock
70071675907

UPC
10093045938114

Alternative ID
TEP-WINDSCREEN



**3M™ Protecta® Rope Lifeline
with Snap Hook Both Ends
AC215A2, 5/8 in Nylon, White,
50 ft**

3M Stock
7012822259

Previous 3M Stock
AC215A2

UPC
00648250031001



**3M™ PROTECTA® PRO™
Rope Lifeline with Snap Hook
1299998, 1 EA**

3M Stock
7100218794

UPC
00840779078073

Alternative ID
1299998



**3M™ Protecta® Rope Lifeline
with Swivel Snap Hook 1299997,
5/8 in Polyester and
Polypropylene Blend, White, 50
ft**

3M Stock
7012817332

UPC
00840779078066

Alternative ID
1299997



**3M™ DBI-SALA® 3-Piece
Portable Davit Base**



3M™ Scott™ ACSi SCBA

3M Stock
B5005047160

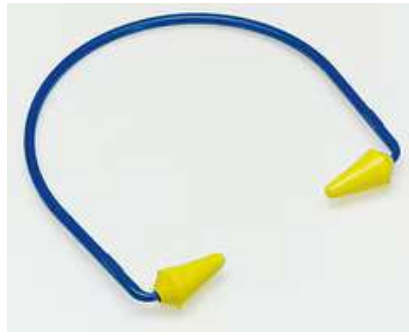

3M™ E-A-R™ Caboflex™ Model 600 Hearing Protector 320-2001, 100 Pair/Case

3M Stock
7000002297
Previous 3M Stock
70071514817
UPC
10080529200003
Alternative ID
320-2001



3M™ Disposable Protective Oversleeve 444, Universal Size, 150 pairs/Case

3M Stock
7000089717
UPC
04046719402823



3M™ Disposable Lab Coat



3M™ Protective Coverall 4515

3M Stock
B00046820



**3M™ PRO-PROTECT
ELECTRONIC HEARING PROTECTOR**

3M™ Pro-Protect Wireless Electronic Hearing Protector with Bluetooth® Technology 90545H1-DC-PS, 4/case

3M Stock
70009127427
UPC
00638060922385



3M™ Pro-Protect Wireless Gel Electronic Hearing Protector with Bluetooth® Technology 90545-SIOC, 1/case
3M Stock
70009127443
UPC
00638060922408



3M™ Pro-Comms Wireless Gel Electronic Hearing Protector with Bluetooth® Technology 90546-SIOC, 1/case
3M Stock
70009127435
UPC
00638060922392



3M™ GoggleGear™ 500 Series GG500-PI, Prescription Insert



3M™ Disposable Protective Overboot Cover 440, Universal Size, 100 Pairs EA/Case
3M Stock
7000089719
UPC
04046719402861
Alternative ID
440



3M™ Protective Coverall 4535
3M Stock
B00046827



3M™ DBI-SALA® Delta™ Safety Harness



3M™ PELTOR™ ORA TAC Big Button Connector, CON-SDBB, 1 each/case

3M Stock
7000128208

Previous 3M Stock
70071615671

UPC
00093045936915

Alternative ID
CON-SDBB



3M™ Scotchlite™ Reflective Material 8932 Series



3M™ DBI-SALA® ExoFit™ XP Safety Harness



3M™ DBI-SALA® Rollgliss™ Descender, Vertical/Auto Retract



3M™ DBI-SALA® FlexiGuard™ Counterweighted System



3M™ Goggle Chemical Splash, 91252H1-DC-10, Black Strap, Clear Lens, 10/case

3M Stock
70006987872

UPC
00078371912529



3M™ Goggle Chemical Splash, 93506P1-DC, Black Strap, Clear Lens, 10/case

3M Stock
70006986346
UPC
00078371912512



3M™ Professional Goggle, Chemical Splash, 91264H1-DC, Black Strap, Gray Lens, 4/case

3M Stock
70006989407
UPC
00078371912642



3M™ Chemical Splash/Impact Goggle, 93506H1-DC, 10/cs

3M Stock
70006982741
UPC
00638060080245



3M™ Protecta® Belt



3M™ Speedglas™ 9000 Series Welding Helmets



3M™ 332 Impact Safety Goggles 40650-00000-10, Clear Lens, 10 EA/Case

3M Stock
7010340634
Previous 3M Stock
70071542602
UPC
10078371621374
Alternative ID
40650-00000-10



3M™ Speedglas™ FA III SAR
V-100 and Speedglas™ Welding
Helmet 9100 FX- Air,

26-5702-30iSW, ADF 9100XXi 1
EA/CS

3M Stock
B00040342

UPC
00051131277816



3M™ Speedglas™ 9100 QR
Earmuff Expander Bar
06-0118-00QR, 1 EA/Case

3M Stock
7100031974

Previous 3M Stock
70071669082

UPC
00051141563701

Alternative ID
06-0118-00QR



3M™ Speedglas™ G5-02
Magnification Plate 08-0500-57,
2.0X

3M Stock
7100239734

Previous 3M Stock
70071736121

UPC
00076308944452

Alternative ID
08-0500-57



3M™ Speedglas™ G5-02
Magnification Plate 08-0500-58,
2.5X

3M Stock
7100239737

Previous 3M Stock
70071736139

UPC
00076308944469

Alternative ID
08-0500-58



3M™ Speedglas™ Welding
Helmet Magnification Plate 3.0X
06-0500-59, 1 EA/Case

3M Stock
7000127146

Previous 3M Stock
70071510427

UPC
00051135893838

Alternative ID
06-0500-59



3M™ Speedglas™ Welding
Helmet Magnification Plate 2.5X
06-0500-58, 1 EA/Case

3M Stock
7000127145

Previous 3M Stock
70071510419

UPC
00051135893821

Alternative ID
06-0500-58



**3M™ Speedglas™ Welding
Helmet Magnification Plate 2.0X**
06-0500-57, 1 EA/Case

3M Stock
7000127144
Previous 3M Stock
70071510401
UPC
00051135893814
Alternative ID
06-0500-57



**3M™ Speedglas™ Welding
Helmet Magnification Plate 1.5X**
06-0500-56, 1 EA/Case

3M Stock
7000127143
Previous 3M Stock
70071510393
UPC
00051135893807
Alternative ID
06-0500-56



**3M™ DBI-SALA® Fall Protection
for Tools Holsters**



**3M™ Speedglas™ Outside
Protection Plates**



**3M™ Facepiece Lens 7884,
Replacement Part 5 EA/Case**

3M Stock
7000051872
Previous 3M Stock
70070408516
UPC
50051138291148
Alternative ID
7884



**3M™ Full Facepiece Button
7989, 54 EA/Case**

3M Stock
7000126202
Previous 3M Stock
70070710457
UPC
50051138542608
Alternative ID
7989



3M™ Button FF-400-02, 30 EA/Case

3M Stock
7000052735

Previous 3M Stock
70071516853

UPC
50051135894748

Alternative ID
FF-400-02



3M™ Welding Face Seals



3M™ DBI-SALA® ExoFit™ NEX™ Safety Harness



3M™ DBI-SALA® Steel Plate Anchor 2104550, 1 EA

3M Stock
7100188847

UPC
00840779011889

Alternative ID
2104550



3M™ Half Facepiece Reusable Respirator Assembly 6191/07001(AAD), P100, Small 24 EA/Case

3M Stock
7010383694

Previous 3M Stock
70070614428

UPC
50051131070016

Alternative ID
6191



3M™ Half Facepiece Respirator Assembly 6391/07003(AAD), Large, with 3M™ Particulate Filters 2091/07000(AAD), P100 24 EA/Case

3M Stock
7000126164

Previous 3M Stock
70070614444

UPC
50051131070030

Alternative ID
6391



3M™ Half Facepiece Respirator Assembly 6291/07002(AAD), Medium, with 3M™ Particulate Filters 2091/07000(AAD), P100 24 EA/...

3M Stock
7000126163
Previous 3M Stock
70070614436
UPC
50051131070023
Alternative ID
6291



3M™ Cartridge/Filter Adapter 701, 20 EA/Case

3M Stock
7000126044
Previous 3M Stock
70070408508
UPC
50051138291131
Alternative ID
701



3M™ Filter Adapter 603, 16 ea/Case

3M Stock
7100066104
UPC
50051141560552
Alternative ID
603



3M™ Band Clamp 7914, 5 EA/Case

3M Stock
7000126016
Previous 3M Stock
70070222669
UPC
50051138214260
Alternative ID
7914



3M™ Nose Cup Assembly 7881S, Silicone, 5 EA/Case

3M Stock
7000001919
Previous 3M Stock
70070221257
UPC
50051138213416
Alternative ID
7881S



3M™ Coalescing Filter W-3012/07008(AAD) 1 EA/Case

3M Stock
7000005397
Previous 3M Stock
78802945549
UPC
00051131070080
Alternative ID
W-3012



**3M™ Filter Cartridge
W-2811-10/07007(AAD), 10
ea/Case**

3M Stock
7000005377
Previous 3M Stock
78800861599
UPC
50051131070078
Alternative ID
W-2811-10



**3M™ Calibration Kit 529-04-48,
Large, 1 EA/Case**

3M Stock
7000052154
Previous 3M Stock
70070888808
UPC
00051138727871
Alternative ID
529-04-48



**3M™ Calibration Kit 529-04-49,
1 EA/Case**

3M Stock
7100008186
Previous 3M Stock
78812400121
UPC
00051138720124
Alternative ID
529-04-49



**3M™ Airflow Indicator 520-01-21
1 EA/Case**

3M Stock
7000131712
Previous 3M Stock
78812400568
UPC
00051138720568
Alternative ID
-504013



**3M™ Adflo™ Flow Indicator
15-0099-05, 1 EA/Case**

3M Stock
7000126724
Previous 3M Stock
70071268406
UPC
00051131925892
Alternative ID
15-0099-05



**3M™ Versaflo™ Air Flow
Indicator TR-973, for TR-600
PAPR with BT-63/64 Breathing
Tube 1/case**

3M Stock
7100167216
UPC
00051131277571
Alternative ID
TR-973



**3M™ High Efficiency Filter
Element W-3013-4/07009(AAD)
4/Case**

3M Stock
7000130752
Previous 3M Stock
78802945556
UPC
50051131070092
Alternative ID
W-3013-4

**3M™ Zero Gas Cylinder
529-05-17, Large, 1 EA/Case**

3M Stock
7000126385
Previous 3M Stock
70070888790
UPC
00051138727888
Alternative ID
-500609

**3M™ Zero Gas Cylinder
529-05-18, 1 EA/Case**

3M Stock
7000131706
Previous 3M Stock
78812400147
UPC
00051138720148
Alternative ID
-500608



**3M™ Filter Bowl W-2915M,
Aluminum 1 EA/Case**

3M Stock
7000126949
Previous 3M Stock
70071401916
UPC
00051131985384
Alternative ID
W-2915M



**3M™ Versaflo™ Air Flow
Indicator TR-971, for TR-600
PAPR, 1 EA**

3M Stock
7100035846
Previous 3M Stock
70071668076
UPC
00051141567075
Alternative ID
TR-971



**3M™ PELTOR™ COMTAC™ IV
Hybrid Gel Ear Seals for
Communication Headset,
HY400, 1 EA/Case**

3M Stock
7010303881
UPC
00093045935994
Alternative ID
HY400



**3M™ E-A-R™ Clear Ear
319-1002, 1 EA/Case**

3M Stock
B00037715
UPC
10080529190021



**3M™ PELTOR™ X3 Hygiene Kit
HYX3/37282(AAD), for X3
Earmuffs, 10 Kits EA/Case**

3M Stock
7000104047
Previous 3M Stock
XA007707590
UPC
04046719723515
Alternative ID
HYX3



**3M™ PELTOR™ X2 Hygiene Kit
HYX2/37281(AAD), for X2
Earmuffs, 10 Kits EA/Case**

3M Stock
7000104046
Previous 3M Stock
XA007707582
UPC
04046719723492
Alternative ID
HYX2



**3M™ PELTOR™ X1 Hygiene Kit
HYX1/37280(AAD), for X1
Earmuffs, 10 Kits EA/Case**

3M Stock
7000104045
Previous 3M Stock
XA007707574
UPC
04046719723478
Alternative ID
HYX1



**3M™ PELTOR™ X2 Earmuffs
X2B, Behind-the-Head, 10
EA/Case**

3M Stock
7100123156
Previous 3M Stock
UU008197723
UPC
10078371671263
Alternative ID
X2B



**3M™ Specialty Particulate
Respirators 8000 Cup Series**



**3M™ E-A-R™ Roll Model
319-1003, 1 EA/Case**

3M Stock
7100179589
UPC
00080529190031
Alternative ID
319-1003



**3M™ Hood BE-10BR, (Formerly
522-02-23R01), Butyl Rubber, 1
EA/Case**

3M Stock
7000131727
Previous 3M Stock
78812400949
UPC
00051138720940
Alternative ID
BE-10BR



**3M™ Versaflo™ Flame
Resistant Headgear Cover
M-972/37331(AAD), 1 EA/Case**

3M Stock
7000052877
Previous 3M Stock
70071562246
UPC
00051131373310
Alternative ID
M-972



**3M™ Versaflo™ Head Neck and
Shoulder Cover
M-976/37332(AAD), for M-100
and M-300 Series Welding
Helmets, 1 EA/Case**

3M Stock
7000030015
Previous 3M Stock
70071562253
Alternative ID
M-976



**3M™ Speedglas™ 9100-Air
Welding Helmet 25-0099-35SW,
with SideWindows and Extended
Headcover, No ADF, 1 EA/Case**

3M Stock
7000128105
Previous 3M Stock
70071607660
UPC
00051131498334
Alternative ID
25-0099-35SW



**3M™ X5-SWBD01 Black/Grey
Replacement Sweat Band for
SecureFit™ Safety Helmet**

3M Stock
7100180680
Alternative ID
X5-SWBD01



**3M™ Metal Mesh Faceshield
V1A-10P, Black 10 EA/Case**

3M Stock
7000103808

Previous 3M Stock
XA007704092

UPC
10093045936165

Alternative ID
V1A-10P



**3M™ Nylon Mesh Faceshield
V1B-10P, Black 10 EA/Case**

3M Stock
7000103809

Previous 3M Stock
XA007704100

UPC
10093045936172

Alternative ID
V1B-10P



**3M™ E-A-R™ UltraFit™
Earplugs**



**3M™ E-A-R™ Push-Ins™
Earplugs**



**3M™ Protecta® Positioning and
Restraint Lanyard**



**3M™ Replacement Blower
TR-301N+, for Versaflo™
TR-300N+ 1 EA/Case**

3M Stock
7100153842

UPC
00076308942625

Alternative ID
TR-301N+



3M™ Breathe Easy™ Turbo Replacement Motor Blower Assembly and Filter Carrier
022-45-00R01, 1 EA/Case

3M Stock
7000126308
Previous 3M Stock
70070844116
UPC
00051138663117
Alternative ID
022-45-00R01



3M™ Powerflow™ Replacement Motor Blower Assembly
024-00-02R01, 1 ea/Case

3M Stock
7000126344
Previous 3M Stock
70070885077
UPC
00051138722036
Alternative ID
024-00-02R01



3M™ Chin Strap for Premium Head Suspension
S-958/37252(AAD) 4 EA/Case

3M Stock
7000127464
Previous 3M Stock
70071534484
UPC
00051131372528
Alternative ID
S-958



3M™ W Series Face Shields & Visors



3M™ DBI-SALA® FlexiGuard™ A-Frame System, Fixed Height

3M Stock
B00036705



3M™ Protecta® Synthetic Horizontal Lifeline System without Anchor Straps



3M™ DBI-SALA® Temporary Cable Horizontal Lifeline HLL Lifeline Assembly



3M™ DBI-SALA® Rollgliss™ R350 3:1 Rescue & Positioning Device



3M™ Nuvo™ Reader Safety Glasses



3M™ Virtua™ Protective Eyewear



3M™ Collar FT-15, 1 ea/Case

3M Stock
7000051789
Previous 3M Stock
70070121499
UPC
00051138163549
Alternative ID
FT-15



3M™ Test Hood FT-14, 10 ea/Case

3M Stock
7000051788
Previous 3M Stock
70070121481
UPC
50051138163537
Alternative ID
FT-14



3M™ Protecta® Lanyard



3M™ DBI-SALA® Equipment
Carrying/Storage Bag 9506162,
9 in x 9 in x 30 in

3M Stock
7100231989
UPC
00648250170892
Alternative ID
9506162



3M™ DBI-SALA® Equipment
Carrying and Storage Bag
9503806, 10.5 in x 12 in x 19.5
in

3M Stock
7012691199
UPC
00840779005857
Alternative ID
9503806



3M™ PELTOR™ WS™ LiteCom
PRO III Headsets



3M™ Faceshield Cover
H-111-100/07043(AAD), 100
ea/Bag

3M Stock
7100138629
Previous 3M Stock
70070798023
UPC
50051131070436



3M™ Versaflo™ Comfort Face
Seal M-936/37326(AAD), 5
EA/Case

3M Stock
7000127692
Previous 3M Stock
70071562204
UPC
00051131373266
Alternative ID
M-936



3M™ Versaflo™ Flame Resistant Face Seal M-937, 5 EA/Case

3M Stock
7100077228
Previous 3M Stock
70071562212
UPC
00051131173316
Alternative ID
M-937



3M™ Versaflo™ Standard Face Seal M-935/37325(AAD), 5 EA/Case

3M Stock
7000127691
Previous 3M Stock
70071562196
UPC
00051131373259
Alternative ID
M-935



3M™ DBI-SALA® Winch/SRL Mating Mounting Bracket for UCT Tripod 8510207

3M Stock
7100209338
UPC
00840779004003
Alternative ID
8510207



3M™ DBI-SALA® Confined Space Winch/SRL Mounting Bracket for UCT 10 ft Tripod 8512292

3M Stock
7012494922
UPC
00840779008759
Alternative ID
8512292



3M™ Readers Safety Glasses, 91192H1-C, +2.0 Blk Frm, Clr Lens

3M Stock
70006985678
UPC
00078371911928



3M™ Readers Safety Glasses, 91193H1-C, +2.5, Blk Frm, Clr Lens

3M Stock
70006985686
UPC
00078371911935



**3M™ Readers Safety Glasses
91191H1-C, +1.5 Blk Frm, Clr
Lens**

3M Stock
70006985660

UPC
00078371911911



**3M™ DBI-SALA® Manhole
Collar Davit Base**



**3M™ PROTECTA® Cable
Anchorage Extensions**



**3M™ Speedglas™ Hard Hat
27-0099-72, for 9100MP
Welding Helmets, 1 EA/Case**

3M Stock
7000128227

Previous 3M Stock
70071621620

Alternative ID
27-0099-72



**3M™ Speedglas™ G5-03 Pro
Hard Hat Adapter 10-5014-00,
for X-5000 Series Hard Hats**

3M Stock
7100312232

Previous 3M Stock
70100400178

UPC
00638060430637

Alternative ID
10-5014-00



**3M™ Speedglas™ G5-03 Pro
Hard Hat Adapter 10-0714-00,
for H-700 Series Hard Hats**

3M Stock
7100312633

Previous 3M Stock
70100400053

UPC
00638060430620

Alternative ID
10-0714-00



3M™ Rugged Comfort Half Facepiece Reusable Respirator 6501/49487, Small, 10 EA/Case

3M Stock
7000128236
Previous 3M Stock
70071621810
UPC
50051131494874
Alternative ID
6501



3M™ Rugged Comfort Half Facepiece Reusable Respirator 6503/49491, Large, 10 EA/Case

3M Stock
7000128240
Previous 3M Stock
70071621851
UPC
50051131494911
Alternative ID
6503



3M™ Paint Project Respirator with Quick Latch 6503QLP1-DC-PS, Size Large, 1 Ea/Pk, 4 Pks/Cs

3M Stock
70009124663
UPC
00638060857786



3M™ Removable DIN Connector 7886, Replacement Part 2 EA/Case

3M Stock
7000130998
Previous 3M Stock
78806027328
UPC
50051138214208
Alternative ID
7886



3M™ Eyeglass Frame and Mount 7894/7894-AM, Accessory, with Case 1 EA/Case

3M Stock
7000125980
Previous 3M Stock
70070079440
UPC
00021200603792
Alternative ID
7894



3M™ Full Facepiece Reusable Respirator 7800S-S, Small, Silicone 1 EA/Case

3M Stock
7000126199
Previous 3M Stock
70070710259
UPC
00051138542573
Alternative ID
7800S-S



3M™ Breathe Easy™ PAPR Systems

3M™ Portable Compressed Air Filter and Regulator Panel 256-02-01, 100 cfm, 8 outlets, with Carbon Monoxide Monitor 1 EA/Case

3M™ Welding Prefilters

3M Stock
7000052147

Previous 3M Stock
70070884260

UPC
00051138721220

Alternative ID
-600426



3M™ Standard Belt TR-325, for Versaflo™ TR-300 PAPR, 1 EA/Case

3M Stock
7000127707

Previous 3M Stock
70071563541

UPC
00051131173590

Alternative ID
TR-325

3M™ Adflo™ Powered Air Purifying Respirator Belt 35-0099-14, with Quick Connection, 1 EA/Case

3M Stock
7100025876

Previous 3M Stock
70071651999

UPC
00051141560830

Alternative ID
35-0099-14

3M™ Comfort Belt CB-1000/37054(AAD) 1 EA/Case

3M Stock
7000126406

Previous 3M Stock
70070892719

UPC
00051131370548

Alternative ID
CB-1000



**3M™ Versaflo™ Waist Belt
W-2963/07045(AAD), Cotton 1
EA/Case**

3M Stock
7000130736
Previous 3M Stock
78802552337
UPC
00051131070455
Alternative ID
W-2963



**3M™ High Durability Belt
TR-326, for Versaflo™ TR-300 &
Speedglas™ TR-300-SG PAPP,
1 EA/Case**

3M Stock
7000127708
Previous 3M Stock
70071563558
UPC
00051131173606
Alternative ID
TR-326



**3M™ Versaflo™ Belt Extender
TR-626X, for TR-626 High
Durability Belt, 1 EA/Case**

3M Stock
7100035832
Previous 3M Stock
70071618147
UPC
00051131373440
Alternative ID
TR-626X



**3M™ Easy Clean Belt TR-327,
for Versaflo™ TR-300 PAPP, 1
ea/Case**

3M Stock
7100232714
UPC
00638060430873
Alternative ID
TR-327



**3M™ Adflo™ Leather Belt
15-0099-16, 1 EA/Case**

3M Stock
7000126728
Previous 3M Stock
70071268455
UPC
00051131925946
Alternative ID
15-0099-16



**3M™ Waist Belt
GVP-127/07152(AAD), Web, 1
EA/Case**

3M Stock
7000126154
Previous 3M Stock
70070610145
UPC
50051138293661
Alternative ID
GVP-127



**3M™ Waist Belt GVP-117, Vinyl,
1 EA/Case**

3M Stock
7000126101
Previous 3M Stock
70070515765
UPC
00051138292232
Alternative ID
GVP-117



**3M™ Decon Belt RBE-BLT, 1
EA/Case**

3M Stock
7000126825
Previous 3M Stock
70071287778
UPC
00051131918887
Alternative ID
RBE-BLT



**3M™ V-Series Supplied Air
Regulator Valves & Assemblies**



**3M™ Health Care Particulate
Respirator & Surgical Mask 1860
Series**



**3M™ VFlex™ Particulate
Respirators 9100 Series**



**3M™ PELTOR™ Welding
Hygiene Kit HY505, for Welding
Earmuffs, 10 EA/Case**

3M Stock
7000103822
Previous 3M Stock
XA007704274
UPC
04046719543496
Alternative ID
HY505



**3M™ E-A-Rfit™ Dual-Ear
Microphone Assembly 073-781**

3M Stock
7100077867

Previous 3M Stock
70071674694

UPC
00078371670146

Alternative ID
073-781



**3M™ E-A-RLINK™ Foam
Eartips 3B 420-2087, with Black
Tube, Small Size, Beige, 5,000
EA/Case**

3M Stock
7010315304

Previous 3M Stock
70071647005

UPC
10080529191288

Alternative ID
420-2087



**3M™ E-A-RLINK™ Foam
Eartips 3B 420-2007, with Black
Tube, Pediatric Size, Beige, 750
EA/Case**

3M Stock
7100041770

Previous 3M Stock
70071615937

UPC
10080529510164

Alternative ID
420-2007



**3M™ E-A-RLINK™ Foam
Eartips 3A 420-2005, with Black
Tube, Adult Size, Yellow, 750
EA/Case**

3M Stock
7010342197

Previous 3M Stock
70071615911

UPC
10080529510140

Alternative ID
420-2005



**3M™ E-A-RLINK™ Foam
Eartips 3A 420-2086, with Black
Tube, Adult Size, Yellow, 5,000
EA/Case**

3M Stock
7010384797

Previous 3M Stock
70071615994

UPC
10080529191271

Alternative ID
420-2086



**3M™ E-A-RLINK™ Foam Plug-
With-Hole Eartips 5B 420-2034,
1/2 Inch Height, 0.100 in Hole,
10,000 EA/Case**

3M Stock
7010341144

Previous 3M Stock
70071647138

UPC
10080529191356

Alternative ID
420-2034



**3M™ E-A-RLINK™ Foam Plug-
With-Hole Eartips 5C 420-2036,
1/2 Inch Height, 0.100 in Hole,
10,000 EA/Case**

3M Stock
7100135333

UPC
10080529191363

Alternative ID
420-2036



**3M™ E-A-RLINK™ Foam
Eartips 3A 420-2004, with Black
Tube, Adult Size, Yellow, 500
EA/Case**

3M Stock
7100041329

Previous 3M Stock
70071615903

UPC
10080529510133

Alternative ID
420-2004



**3M™ E-A-RLINK™ Foam Plug-
With-Hole Eartips 5A 420-2033,
1/2 Inch Height, 0.100 in Hole,
10,000 EA/Case**

3M Stock
7010384826

Previous 3M Stock
70071647120

UPC
10080529191349

Alternative ID
420-2033



**3M™ E-A-RLINK™ Foam Plug-
With-Hole Eartips 5S 420-2032,
1/2 Inch Height, 0.150 in Hole,
10,000 EA/Case**

3M Stock
7010303907

Previous 3M Stock
70071647112

UPC
10080529191332

Alternative ID
420-2032



**3M™ E-A-RLINK™ Foam
Eartips 3B 420-2006, with Black
Tube, Small Size, Beige, 500
EA/Case**

3M Stock
7010384794

Previous 3M Stock
70071615929

UPC
10080529510157

Alternative ID
420-2006



**3M™ Versaflo™ Replacement
Visor Frame Buttons M-919, 10
EA/Case**

3M Stock
7000127686

Previous 3M Stock
70071562139

UPC
00051131173309

Alternative ID
M-919



3M™ DBI-SALA®
SecuraSpan™ Loop Rebar
Horizontal Lifeline System
7400360, 1 EA

3M Stock
B10434278
UPC
00840779004904



3M™ DBI-SALA®
SecuraSpan™ Pour-in-Place
Horizontal Lifeline System

3M Stock
B00036510



3M™ DBI-SALA® RollGliss™
RPD 4:1 Ratio Rescue
Positioning Device Kit 3602250,
3/8 in Nylon Kernmantle Rope,
250 ft

3M Stock
7012819487
Previous 3M Stock
3602250
Alternative ID
3602250



**3M™ FOAM GASKET
SAFETY EYEWEAR**

3M™ Performance Eyewear
Gasket Design 47200-HZ6-NA,
Mirror Lens, Anti-Fog, 6ea/css

3M Stock
70006991031
UPC
00638060187654



3M™ Performance Eyewear
Anti-Fog, 47091H1-DC,
Black/Red, Gray Lens, 4/case

3M Stock
70006983103
UPC
00076308725907



3M™ Performance Eyewear
Anti-Fog, 47090H1-DC,
Black/Red, Clear Lens, 4/case

3M Stock
70006983095
UPC
00076308725860



3M™ Performance Eyewear
Anti-Fog, 47071H1-DC,
Black/Gray, Gray Lens, 4/Case

3M Stock
70006983087

UPC
00051125004022



3M™ Performance Eyewear
Anti-Fog, 47070H1-DC,
Black/Gray, Clear Lens, 4/Case

3M Stock
70006983079

UPC
00051125004015



3M™ Performance Eyewear
47070H1-DC Black/Gray, Clear
Lens, Anti-Fog, 4/Case

3M Stock
70006983061

UPC
00051125003995



3M™ SecureFit™ Anti-Fog
Eyewear with Scotchgard™
Protector 47213H1-VDC-PS,
Blue/Clear, Clear Lens, Anti-Fog,
5/case

3M Stock
70009126809

UPC
00638060921388



3M™ Brow Guard Eyewear,
47101H1-VDC, Black/Green,
Gray Lens, 5/case

3M Stock
70009110324

UPC
00638060279601



3M™ Virtua™ VX6 Safety
Glasses

3M Stock
B00034292



**3M™ Versaflo™ Painter's
Supplied Air Respirator Kit
SA-100-PSK/37336(AAD), 1
EA/Case**

3M Stock
7000127696
Previous 3M Stock
70071562311
UPC
00051131373365
Alternative ID
SA-100-PSK



**3M™ DBI-SALA® ExoFit™
Comfort Vest Retrieval Safety
Harness 1108750, X-Small**

3M Stock
B00033480
UPC
00840779030002



**3M™ PELTOR™ Charging
Cable FR09 for Lite-Com BRS
Headset Battery ACK053, 1
EA/Case**

3M Stock
7100075611
Previous 3M Stock
XH001680616
UPC
07318640063655



**3M™ PELTOR™ Charging
Cable, AL2AH, 1 EA/Case**

3M Stock
7100067410
Previous 3M Stock
11003072094
UPC
07318640063051
Alternative ID
AL2AH

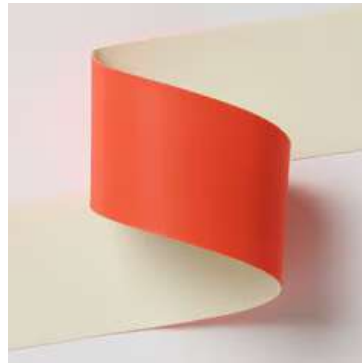

**3M™ Scotchlite™ Reflective
Material 8986 Series**



**3M™ Scotchlite™ Reflective
Material 8925 Series**



3M™ DBI-SALA® Confined Space Tripod System



3M™ Protecta® Compact Equipment Storage Pouch AK048A, 12 in x 0.5 in x 12.5 in

3M Stock
7012822282

Previous 3M Stock
AK048A

Alternative ID
AK048A



3M™ Spill Control Safe Bucket with Hook and Loop Closure 1500140, 250 lb Capacity, Vinyl, 12.5 in dia x 15 in

3M Stock
7100241957

UPC
00840779112326

Alternative ID
1500140



3M™ Spill Control Safe Bucket with Drawstring Closure 1500139, 250 lb Capacity, Vinyl, 12.5 in dia x 15 in

3M Stock
7100279876

UPC
00840779112319

Alternative ID
1500139



3M™ Spill Control Long Safe Bucket with Hook and Loop Closure 1500136, 100 lb Capacity, Canvas, 48 in

3M Stock
7100237395

UPC
00852684934740

Alternative ID
1500136



3M™ DBI-SALA® Inspection Pouch 1500131, 1 EA

3M Stock
7100210236

Previous 3M Stock
1500131

UPC
00852684932210

Alternative ID
1500131



3M™ DBI-SALA® Cell Phone Holder Pouch For Harness 9501264, Hook and Loop

3M Stock
7012821177
Previous 3M Stock
9501264
UPC
00840779002801
Alternative ID
9501264



3M™ Utility Tool Pouch 1500132, Canvas, White

3M Stock
7100270183
UPC
00852684932548
Alternative ID
1500132



3M™ Tool Pouch with D-ring and Triggers 1500126, Canvas, Black, 7.5 in x 11 in

3M Stock
7100311719
UPC
00852684932456
Alternative ID
1500126



3M™ Tool Pouch with D-ring 1500124, Canvas, Black, 7.5 in x 11 in

3M Stock
7100238136
UPC
00852684932388
Alternative ID
1500124



3M™ Tool Pouch with D-ring and Retractors 1500128, Canvas, Black, 8.75 in x 13 in

3M Stock
7100314288
Previous 3M Stock
1500128
Alternative ID
1500128



3M™ DBI-SALA® Flexiguard™ Trailer Mounted Adjustable Height Anchor System 8530690, 2 User, Yellow, 12.75 – 20.5 ft

3M Stock
7100231988
UPC
00840779108152
Alternative ID
8530690



3M™ DBI-SALA® Floor Mount Sleeve Davit Base



3M™ PELTOR™ Patch Cable, FL6BR-01, 1 EA/CS



3M™ E-A-Rsoft™ SuperFit™ Earplugs

3M Stock
7100221037

Alternative ID
FL6BR-01



3M™ PELTOR™ ProTac Hunter (Slim) Headset, Green, Headband

3M Stock
7100088458

Previous 3M Stock
UU004690648

UPC
04054596123137

Alternative ID
MT13H222A



3M™ PELTOR™ Tactical Sport™ MT16H210F-SV, Electronic Headset, Foldable Headband, Black, 10 Each/Case

3M Stock
7010301924

Previous 3M Stock
70071558608

UPC
10093045934079

Alternative ID
MT16H210F-SV



3M™ PELTOR™ Tactical Sport™ MT16H210F-479-SV, Electronic Headset, Foldable Headband, Black, 10 Each/Case

3M Stock
7000108437

Previous 3M Stock
XH001678479

UPC
07318640045286

Alternative ID
MT16H210F-479-SV



**3M™ Scotchlite™ Reflective
Material 9920 Series**



**3M™ PELTOR™ Triple-C
Communication Eartips CCC-
GRM-25, 25 Pair/Case**

3M Stock
7100103087
Previous 3M Stock
70071675212
UPC
10078371670587
Alternative ID
CCC-GRM-25



**1173 SV/1 BATTERY COVER
BLACK PIN PACK**

3M Stock
7000039640
Previous 3M Stock
XH001651666
Alternative ID
1173 SV



**3M™ PELTOR™ Flexible Boom
Speech Microphone MT34/1, 10
ea/Case**

3M Stock
7100231592
UPC
07318640071292
Alternative ID
MT34/1



**3M™ PELTOR™ Boom
Microphone MT7V/1, 20
ea/Case**

3M Stock
7100099097
UPC
07318640067035
Alternative ID
MT7V/1



**3M™ PELTOR™ Boom
Microphone MT53V/1, 20
ea/Case**

3M Stock
7100098955
UPC
07318640067028
Alternative ID
MT53V/1



**3M™ PELTOR™ Flexible
Dynamic Boom Microphone**

3M Stock
7100157305
UPC
00093045938230
Alternative ID
MT33-05R



**3M™ PELTOR™ Flexible Boom
Speech Microphone, MT33/1, 1
EA/CS**

3M Stock
7100112093
UPC
07318640067530
Alternative ID
MT33/1



**3M™ Solus™ 2000 Series
S2000-FOAM Replacement
Foam Gasket, 10PK, 12
pack/Case**

3M Stock
7100223280
UPC
50638060429223
Alternative ID
S2000-FOAM



**3M™ SecureFit™ 500 Series
SF500-FOAM, Replacement
Foam Gasket, 10 ea/bag, 12
bags/Case**

3M Stock
7100239114
UPC
50638060430731
Alternative ID
SF500FOAM



**3M™ VIRTUA™ CCS Protective
Eyewear Replacement Foam
Gasket VCRG1, 10 ea/Case**

3M Stock
7010316613
Previous 3M Stock
70071674769
UPC
50051141567902
Alternative ID
VCRG1



**3M™ PELTOR™ LiteCom FRS
Headset MT53H7A4602-NA,
Headband, 10 ea/Case**

3M Stock
7100204442
UPC
07318640069664
Alternative ID
MT53H7A4602-NA



3M™ PELTOR™ LiteCom FRS Headset MT53H7B4602-NA, Neckband, 10 ea/Case

3M Stock
7100204441

UPC
07318640069671

Alternative ID
MT53H7B4602-NA



3M™ Scotchlite™ Reflective Material 8987 Series



3M™ Perfect-It™ Paint Finishing Apron

3M Stock
B40069503



3M™ Anti-Fog Goggle with Scotchgard™ Protector 47212H1-VDC, Gray/Red, Clear Lens, 5/cs

3M Stock
CBGNAWUS1876

UPC
00638060279625



Peltor™ Sport SecureFit™ 400 Eye Protection SF400-P3PK-6, 3 Pack: Clear + Amber + Gray Lenses, Anti Fog

3M Stock
CBGNAR2369

UPC
00051141995090



FUTURO™ Open Toe/Open Heel Knee Length Stocking

3M Stock
CBGBLW011026

UPC
00051131201095



FUTURO™ Anti-Embolism Thigh Length Stockings

3M Stock
CBGBLW011014

UPC
00051131201675



Peltor™ Sport SecureFit™ Safety Eyewear SF400-PC-9, Clear/AF Lens, 9 ea/cs

3M Stock
CBGBLRUS1535

UPC
00638060267219



3M™ Anti-Fog Goggle with Scotchgard™ Protector 47211H1-VDC, Black/Blue, Gray Lens

3M Stock
CBGNAWUS1875

UPC
00638060280775



3M™ WorkTunes™ Connect + AM/FM Hearing Protector

3M Stock
CBGNARUS2453

UPC
00076308726539



Peltor™ Sport Tri-Flange™ Corded Reusable Earplugs 97317-10C, 3 Pair Pack Neon Yellow

3M Stock
CBGNAR2368

UPC
00078371610067



3M™ Kids Hearing Protection PKIDSB-BLU, Blue, 4 ea/case

3M Stock
CBGNAWUS1885

UPC
00638060661789



FUTURO™ Opaque Tights

3M Stock
CBGBLRUS1517

UPC
00051131215054



3M™ WorkTunes™ Connect + Gel Cushions Hearing Protector with Bluetooth® technology

3M Stock
CBGNAWUS1817

UPC
00638060278130



3M™ Disposable Earplugs

3M Stock
CBGNAW011196

UPC
00051141333533



3M™ Welding Valved Respirator 8515HA1-A-PS 1 ea/pk, 12 pks/cs

3M Stock
CBGNAW011066

UPC
00051131800243



3M™ WorkTunes™ Connect Wireless Hearing Protector

3M Stock
CBGNAWUS1754

UPC
00076308913267



Peltor™ Sport Over The Glass Safety Eyewear 47030-PEL-6, Clear, 6/Case

3M Stock
CBGNAWUS1743

UPC
00076308730024



Peltor™ Sport Tactical 500
Electronic Hearing Protector,
TAC500-OTH, 1 Hearing
Protector, 4/Case

3M Stock
CBGNARUS2571
UPC
00076308913373



FUTURO™ Open Toe Knee
Length Stockings

3M Stock
CBGBLW011025
UPC
00051131201064



FUTURO™ Anti-Embolism
Stockings Knee Length, Closed
Toe

3M Stock
CBGBLW011013
UPC
00051131201620



3M™ Safety Eyewear Polarized,
90214-HZ4-NA, Blk Frame, AF &
Scratch Resistant Lens, 4/cs

3M Stock
CBGNAWUS1771
UPC
00638060081402



Peltor™ Sport Shotgunner™ II
Low-Profile Hearing Protector,
24 NRR Black/Gray

3M Stock
CBGNARUS2506
UPC
00051125005647



3M™ Disposable Classic
Earplugs

3M Stock
CBGNAW011163
UPC
00078371905811



3M™ 6023 Performance Replacement Kit OV/P95 with cartridges, filters, and retainers for the 3M™ Performance Reusable Pain...

3M Stock
CBGNAW011116
UPC
00051131371507



FUTURO™ Ultra Sheer Pantyhose for Women (French Cut)

3M Stock
CBGBLW011018
UPC
00051131201330



3M™ PELTOR™ SCU-300 Cable Dust Cap DE0438/1, 20 ea/Case

3M Stock
7100228566
UPC
07318640070752
Alternative ID
DE0438/1



3M™ PELTOR™ Cable SCU-FL018, Motorola XTS1500/HT1000, 20 ea/Case

3M Stock
7100233149
UPC
07318640070721
Alternative ID
SCU-FL018



3M™ Protecta® Rope Lifeline with Carabiner AC230A1, 5/8 in Nylon, White, 100 ft

3M Stock
7100188817
Previous 3M Stock
AC230A1
UPC
00648250031353
Alternative ID
AC230A1



3M™ DBI-SALA® Tongue Buckle Belt 1000057, Yellow, 3X

3M Stock
7012814955
Previous 3M Stock
1000057
UPC
00840779014286
Alternative ID
1000057



3M™ Peltor™ Optime™ 95 Cap-Mount Earmuffs, Hearing Conservation H6P3E/V 10 EA/Case

3M Stock
7000052743
Previous 3M Stock
70071517075
UPC
10093045080653
Alternative ID
H6P3E/V

3M™ PELTOR™ ComTac™ VII AL8002/1 Download Cable, 20 ea/Case

3M Stock
7100225790
UPC
07318640070769
Alternative ID
AL8002/1

3M™ PELTOR™ ComTac™ VII 1086 SV/1, Battery Lid, 20 ea/Case

3M Stock
7100232689
UPC
07318640070738
Alternative ID
1086 SV/1



3M™ Black Demo Tip Foam plug-with-hole 1/2 inch height, 0.150 in hole 420-2066, 1,000 EA/Case

3M Stock
7010384828
Previous 3M Stock
70071647179
UPC
10080529191394
Alternative ID
420-2066

3M™ DBI-SALA® Pass-Thru Adjustable Web Tie-Off Adapter Anchor 1002105, Polyester, 5 ft

3M Stock
7012815110
Previous 3M Stock
1002105
UPC
00840779016389
Alternative ID
1002105

3M™ E-A-R™ UltraFit™ Plugs-with-Hole Short Stem Earplugs 420-2101, Clear, 10,000 Pair/Case

3M Stock
7010341878
Previous 3M Stock
70071578242
UPC
50076308945775
Alternative ID
420-2101



**3M™ PELTOR™ Yellow
LEP-200 Replacement Charging
Case, 1 ea/cs**

3M Stock
7100079510

Previous 3M Stock
70071675139

UPC
00078371670719

Alternative ID
LEP-100C



**3M™ DBI-SALA® Coated Web
Scaffold Choker Anchor
1201421, Polyester, 4 ft**

3M Stock
7012816942

Previous 3M Stock
1201421

UPC
00840779066643

Alternative ID
1201421



**3M™ 1260/1270/1271 Probed
Test Plugs, 393-2016-50,
50/Case**

3M Stock
7100034169

UPC
10078371664838



**3M™ Ratchet Kit W-3261, 1
EA/Case**

3M Stock
7000126041

Previous 3M Stock
70070406585

UPC
00051138291938

Alternative ID
W-3261



**3M™ Exhalation Valve 7283, 50
EA/Case**

3M Stock
7000125987

Previous 3M Stock
70070091981

UPC
50051138087437

Alternative ID
7283



**3M™ Surgical and Specialty
Masks**

3M Stock
B00038103



**3M™ Inhalation Valve 7282, 200
EA/Case**

3M Stock
7000125986

Previous 3M Stock
70070091973

UPC
50051138087420

Alternative ID
7282



**3M™ PELTOR™ FL6CE/1 3.5
mm Cable**

3M Stock
7000108359

Previous 3M Stock
XH001676952

UPC
07318640054929



**3M™ Flex Adaptor Cable
FL6U-36**

3M Stock
7000107902

Previous 3M Stock
XH001654926

UPC
07318640040052

Alternative ID
FL6U-36



**3M™ PELTOR™ Radio Adapter
Cable FLX-001 GP900/HT1000,
1 EA/Case**

3M Stock
7100065594

Previous 3M Stock
70071674330

UPC
00093045937882

Alternative ID
FLX-001



**3M™ TEKK Protection™
Virtua™ Safety Eyewear
90525-80025T, Blue Mirror Lens**

3M Stock
CBGNAW011209

UPC
10078371612945



**3M™ PELTOR™ Smartphone
Cable SCU-FL090, 3.5 mm, 20
ea/Case**

3M Stock
7100228536

UPC
07318640070882

Alternative ID
SCU-FL090



**3M™ PELTOR™ SCU-FL009,
AN/VIC 3, 20 ea/Case**

3M Stock
7100235882
Previous 3M Stock
UU010965778
UPC
07318640070837
Alternative ID
SCU-FL009



**3M™ PELTOR™ SCU Cable
SCU-FL063, MOTOROLA
MOTOTRBO, 20 Ea/Case**

3M Stock
7100228537
UPC
07318640070875
Alternative ID
SCU-FL063



**3M™ Peltor™ SCU-FL001,
Helicopter Low Impedence, 1
Each/Case**

3M Stock
7100227473
UPC
07318640070776
Alternative ID
SCU-FL001



**3M™ PELTOR™ Cable SCU-
FL030, Motorola GP340, 20
ea/Case**

3M Stock
7100228538
Previous 3M Stock
UU010965760
UPC
07318640070844
Alternative ID
SCU-FL030



**3M™ PELTOR™ SCU Cable
SCU-FL040, MBITR, HARRIS
5800, LVIS USA, 1 Each/Case**

3M Stock
7100227451
UPC
07318640070851
Alternative ID
SCU-FL040



**3M™ E-A-R™ Listen Up Sample
Box 319-1001, 1 ea/Case**

3M Stock
7100009712
Previous 3M Stock
70071520996
Alternative ID
319-1001



3M™ Comfort Grip Gloves - Winter



3M™ Filtering Barrier Face Covering, AFFM-xx

3M Stock
B10083111
UPC
00051131223868



3M™ Flat Temple Eyewear Anti-Scratch, 47010H1-DC, Black/Red, Clear Lens, 6/case

3M Stock
70006983038
UPC
00051141975870



3M™ PELTOR™ P3ADG47-F SV/2 ARC rail attachment, 1 pair/Bag

3M Stock
7100227493
UPC
07318640070974
Alternative ID
P3ADG47-F SV/2



3M™ DBI-SALA® Permanent Weld-On Uni-Anchor with Tie-Off Fall Arrest Post Base 8567422, Sandblasted Steel, 10 in x 8 in CE

3M Stock
7100246254
Previous 3M Stock
8567422
UPC
00648250223895
Alternative ID
8567422



3M™ PELTOR™ ComTac VII Headband AGM/1

3M Stock
7100227486
UPC
07318640070943
Alternative ID
AGM/1



**3M™ PELTOR™ Comfort
Headband HY500, for Headset,
1/Case**
3M Stock
7000089460
Previous 3M Stock
GT600005786
UPC
04054596798717
Alternative ID
HY500



**3M™ PELTOR™ Rechargeable
Li-Ion Battery, ACK082, 1
EA/Case**
3M Stock
7100112102
UPC
04054596256965
Alternative ID
ACK082



**ForceFlex™ Flexible Safety
Eyewear 92232-80025 Black
Half Frame, Clear Lens 4/case**
3M Stock
CBGNAW011068
UPC
50051141326011



**3M™ Peltor™ SCU-300 Dust
Cap Kit DE0437/4, 4 Caps, 20
ea/Case**
3M Stock
7100227470
UPC
07318640070714
Alternative ID
DE0437/4



**3M™ PELTOR™ Spring Steel
Bracket for RCU-300 FE03444/1**
3M Stock
7100226974
UPC
07318640071957
Alternative ID
FE0344/1



**3M™ PELTOR™ ComTac VII
Wind Shield Kit for Surround Mic
M194/2, 20 ea/Case**
3M Stock
7100232688
UPC
07318640070745
Alternative ID
M194/2



**3M™ PELTOR™ ComTac VII
Microphone Guide A47/1**

3M Stock
7100227492
UPC
07318640070950
Alternative ID
A47/1



**3M™ Brow Guard Eyewear,
47100H1-VDC, Black/Green,
Clear Lens, 5/case**

3M Stock
70009110274
UPC
00638060279595



**3M™ PELTOR™ SCU-300
Battery Cap DE0408/1, 20
ea/Case**

3M Stock
7100228540
UPC
07318640070981
Alternative ID
DE0408/1



**3M™ PELTOR™ MT71/1 Boom
Microphone Dyn**

3M Stock
7100230581
UPC
07318640070967
Alternative ID
MT71/1



**3M™ PELTOR™ Dynamic
Boom Mic for MT™ Series,
TacticalPro Two-way, MT7N 1
EA/Case**

3M Stock
4100010841
Alternative ID
MT7N



**Scotch® Photoelectric Scanning
Tape 7800**

3M Stock
B40069709
Alternative ID
7800

Scotch® Photoelectric Scanning Tape 7800

3M Product Number 7800 3M ID B40069709

Details

Exposed-lens retroreflective tape for use as expendable code marks in automatic warehouse operations

Backing provides exceptional contrast for increased accuracy, reliability and depth-of-field in photoelectric and sorting classification systems

Synthetic rubber adhesive bonds to a wide selection of substrates

Performs at consistently high temperatures, including continued exposure at up to 350°F/177°C, and short term exposure up to 500°F/260°C

Backing provides exposed-lens reflective luminance of up to 200X

Heavy crepe paper backing tears easily for ease of use

Typical properties

Brands: Scotch®

eClass 14 Classification Group: 35030590

3M™ PELTOR™ Dynamic Boom Mic for MT™ Series, TacticalPro Two-way, MT7N 1 EA/Case

3M Product Number MT7N 3M ID 4100010841

Details

Flexible dynamic boom microphone for use on select 3M™ PELTOR™ Communication Headsets
Noise-cancelling technology
For use with specific 3M™ PELTOR™ Communication Headsets
3M™ PELTOR™ spare part

Typical properties

Brands: PELTOR™
Microphone Class/Type: Dynamic
Plug Type: J22
Product Color: Black
Product Type: Microphone
Recommended Industry: Agriculture
eClass 14 Classification Group: 40270191

3M™ PELTOR™ MT71/1 Boom Microphone Dyn

Part Number MT71/1 3M Product Number MT71/1 3M ID 7100230581

Details

Embedded with patented 3M closed cell foam, delivers improved noise cancelling transmission in high noise and wind while also improving dust and water ingress protection (IP68, 6m / 30 min)

Easy to replace

For use with specific 3M™ PELTOR™ Communication Headsets

3M™ PELTOR™ spare part

Typical properties

Brands: PELTOR™

Compatible With: ComTac VII Headset

Microphone Class/Type: Dynamic

Product Color: Black

Product Series: MT Series

Product Type: Microphone

eClass 14 Classification Group: 40270191

3M™ PELTOR™ SCU-300 Battery Cap DE0408/1, 20 ea/Case

3M Product Number DE0408/1 3M ID 7100228540 UPC 07318640070981

Details

Replacement battery cap
Ruggedized

Typical properties

Brands: PELTOR™
Case Quantity: 20
Compatible With: SCU-300 System Control Unit
Product Color: Metallic Silver
Product Type: Battery Cap
eClass 14 Classification Group: 40270191

3M™ Brow Guard Eyewear, Black/Green, Clear Lens, 1 Pack

3M ID 70009110274 UPC 00638060279595

Details

Durable lenses help provide limited protection from light to moderate impact hazards
Lightweight, durable design for comfort and lasting wear
Brow guard helps keep sweat and debris out of your eyes
Compatible with many types of additional personal protection equipment (ppe)
Soft touch nose pads and earpiece enhance comfort
Contoured wrap around design provides extended eye protection and unobstructed view
Anti fog, scratch resistant lens helps keep vision clear
Impact-resistant lens blocks 99.9% of UV rays
Meets the requirements of ANSI Z87.1, CSA Z94.3 and AS/NZS 1337
Clear lenses help provide excellent visibility and can be used indoors or outdoor
Contains: 1 Pair of Safety Glasses

Typical properties

Brands: 3M™
Catalog Number: 47100H1-VDC
Factory ISO Certification: No ISO Certification information available
Material: Polycarbonate
Product Color: Black
eClass 14 Classification Group: 40230101

3M™ PELTOR™ ComTac VII Microphone Guide A47/1

3M Product Number A47/1 3M ID 7100227492 UPC 07318640070950

Details

Designed to help accommodate both left handed and right handed shooters
Easy to replace

Typical properties

Brands: PELTOR™
Compatible With: ComTac VII Headset
Product Color: Black
Product Type: Microphone Guide Post
eClass 14 Classification Group: 40270191

3M™ PELTOR™ ComTac VII Wind Shield Kit for Surround Mic M194/2, 20 ea/Case

3M Product Number M194/2 3M ID 7100232688 UPC 07318640070745

Details

In high wind environments, the wind shield can help to minimize effects of wind noise on environmental listening

Easy to replace

For use on different 3M™ PELTOR™ Microphones

3M™ PELTOR™ spare part

Typical properties

Brands: PELTOR™

Compatible With: ComTac VII Headset

Product Color: Black, Gray

Product Type: Wind Shield

eClass 14 Classification Group: 40270191

3M™ PELTOR™ Spring Steel Bracket for RCU-300 FE03444/1

3M Product Number FE0344/1 3M ID 7100226974 UPC 07318640071957

Details

Replacement spring steel bracket
Ruggedized
Resists dust and water

Typical properties

Brands: PELTOR™
Case Quantity: 1
Compatible With: RCU-300 Remote Control Unit
Product Color: Metallic Silver
Product Type: Bracket
eClass 14 Classification Group: 40270191

3M™ Peltor™ SCU-300 Dust Cap Kit DE0437/4, 4 Caps, 20 ea/Case

3M Product Number DE0437/4 3M ID 7100227470 UPC 07318640070714

Details

Helps secure the unit
Ruggedized
Resists dust and water

Typical properties

Brands: PELTOR™
Case Quantity: 20
Compatible With: SCU-300 System Control Unit
Product Color: Black
Product Type: Dust Cap Kit
eClass 14 Classification Group: 40270191

ForceFlex™ Flexible Safety Eyewear 92232-80025 Black Half Frame, Clear Lens 4/case

3M ID 70005085744 UPC 50051141326011

Details

Flexible and resilient frames for a customizable fit
Multi-injection technology fuses lens to the frame
Impact-resistant lenses absorb 99.9% UV, UVA and UVB
Includes microfiber storage bag and lanyard
Meets requirements of ANSI Z87.1-2003

Typical properties

ANSI Requirements: ANSI Z87.1-2003
Brands: 3M™
Factory ISO Certification: No ISO Certification information available
Features: Flexible Frame, Lanyard, Soft Temples, Storage Bag
Frame Color: Black
Lens Coating: Anti-scratch
Lens Color: Clear
Lens T

3M™ PELTOR™ Rechargeable Li-Ion Battery, ACK082, 1 EA/Case

3M Product Number ACK082 3M ID 7100112102 UPC 04054596256965

Details

Only for use with the intrinsically safe WS™ LiteCom Pro III Headset
1 EA/Case
3M™ PELTOR™ spare part
NiMH, AA and Lithium-Ion packs available

Typical properties

Battery Type: Lithium-Ion
Brands: PELTOR™
Product Type: Battery Pack
eClass 14 Classification Group: 40270191

3M™ PELTOR™ Comfort Headband HY500, for Headset, 1/Case

3M Product Number HY500 3M ID 7000089460 UPC 04054596798717

Details

Pad with foam designed for smaller heads to provide better fit
Works with over the head headsets
Wraps around the headband
1 EA/case

Typical properties

Brands: PELTOR™
Product Type: Headband
eClass 14 Classification Group: 40270191

3M™ PELTOR™ ComTac VII Headband AGM/1

3M Product Number AGM/1 3M ID 7100227486 UPC 07318640070943

Details

Simplified cable removal

A complete redesign helps improve comfort when worn under a ballistic helmet

Typical properties

Brands: PELTOR™

Compatible With: ComTac VII Headset

Product Color: Black

Product Type: Headband

eClass 14 Classification Group: 40270191

3M™ DBI-SALA® Permanent Weld-On Uni-Anchor with Tie-Off Fall Arrest Post Base 8567422, Sandblasted Steel, 10 in x 8 in CE

3M Product Number 8567422 3M ID 7100246254 UPC 00648250223895

Details

- Compatible with various fall protection systems
- Compact, lightweight design
- Ideal for use with personal fall arrest systems with self-retracting lifelines
- Recommended for use in the construction, general industrial, mining, oil and gas, transportation, utilities, and wind energy industries
- Portable and reusable
- Corrosion-resistant construction for durability
- This safety equipment is designed for use with additional personal protective equipment (PPE)
- Installs onto 2-3/4 in. to 3-1/4 in. wide rails - (90-141 lbs/yd and 132 lbs head-free rail)
- Fall arrest- and restraint-rated for one worker
- Features high-strength stainless steel construction

Typical properties

- Anchor Install Type: Reusable
- Anchor Type: I-Beam
- Material: Stainless Steel
- Product Series: RailDog™
- Product Type: Beam Trolley

3M™ PELTOR™ P3ADG47-F SV/2 ARC rail attachment, 1 pair/Bag

3M Product Number P3ADG47-F SV/2 3M ID 7100227493 UPC 07318640070974

Details

Accessory rail connector (ARC)
Easy Donning / Doffing
Heat relief in "open" position

Typical properties

Brands: PELTOR™
Compatible With: ComTac VII Headset
Product Color: Black
Product Type: Rail Attachment
eClass 14 Classification Group: 40270191

3M™ Flat Temple Safety Eyewear, Black/Red, Clear Lens

3M ID 70006983038 UPC 00051141975870

Details

Durable, one piece lens helps provide limited protection from light to moderate impact hazards

Lightweight, durable design for comfort and lasting wear

Sleek temples create a comfortable fit when worn with ear protection

When worn with hearing protection, flat temple design limits risk of reduced effectiveness

Flexible nose and ear pieces provide comfort

Scratch resistant coating helps keep vision clear

Impact resistant lens blocks 99.9% of UV rays

Great for use indoors and outdoors

Meets the requirements of ANSI Z87.1, CSA Z94.3 and AS/NZS 1337

Clear lens provides excellent visibility

Typical properties

Brands: 3M™

Catalog Number: 47010H1-DC

Factory ISO Certification: No ISO Certification information available

Frame Material: Polycarbonate

Frame Style: Wraparound

Hard Coat Lens: No

Material: Polycarbonate

Sealed Eyewear: No

Splash Protection: No

Dimensions and Classifications

Overall Height (Imperial): 10 in

Overall Height (Metric): 254 mm

3M™ Filtering Barrier Face Covering

3M ID B10083111 UPC 00051131223868

Details

*Not a NIOSH approved respirator. Tested to ASTM F3502-21 as a Barrier Face Covering
Same product with a new name. 3M™ Advanced Filtering Face Mask is changing to 3M™ Filtering Barrier Face Covering
The stretchable side bands with hook help hold product snugly to face
The filter media filters at least 95% of airborne particles.*
3M proprietary filter media is designed for ease of breathing*
Adjustable noseclip with soft foam helps provide a custom contour
Lightweight design with a smooth inner material to help feel comfortable on your face
Convenient packaging that easily fits in a bag
For use when traveling, running errands, attending personal appointments, or doing other activities where face coverings are needed
Easy to breathe & speak, contoured design
Convenient, disposable design
For everyday use, indoors and out
Available in 1, 3 and 5 packs
Color: White
*ASTM F3502-21 Standard for Barrier Face Coverings. Not a NIOSH approved respirator. Not FDA cleared for use in health care settings

Typical properties

Brands: 3M™
Catalog Number: AFFM-1-DC,AFFM-3,AFFM-5-DC,AFFM-3-DC
Factory ISO Certification: No ISO Certification information available
Package Contents: 3-pack,1-pack,5-pack
Product Color: White
eClass 14 Classification Group: 34150102

3M™ Comfort Grip Gloves - Winter

Details

Excellent dexterity and grip, even in wet or oily conditions
Typical applications include general material handling; handling small parts;
electrical component assembly; carpentry, plumbing, roofing and irrigation
EN388 4121
Long-lasting, durable and washable

Typical properties

EN 388 Mechanical Risk Designations: 4122
Material: Nitrile Foam
Product Color: Gray
Product Type: Winter Work Glove
Size: Large, Medium, X-Large
eClass 14 Classification Group: 40280203

3M™ E-A-R™ Listen Up Sample Box 319-1001, 1 ea/Case

3M Product Number 319-1001 3M ID 7100009712

Details

Contains a variety of 3M earplug samples

1 EA Per Case

Product demonstration tool

*The NRR may overestimate the hearing protection provided during typical use

Typical properties

Brands: E-A-R™

Case Quantity: 1

Cord Type: None

Corded: No

Dispenser Available: No

Hearing Protection Style: Probed for Fit Testing

Product Series: E-A-R Support Materials

Product Type: Earplugs

eClass 14 Classification Group: 40270190

3M™ PELTOR™ SCU Cable SCU-FL040, MBITR, HARRIS 5800, LVIS USA, 1 Each/Case

3M Product Number SCU-FL040 3M ID 7100227451 UPC 07318640070851

Details

Reliable connection
Ruggedized cable and connectors

Typical properties

Brands: PELTOR™
Case Quantity: 1
Compatible Radio Brands: Harris
Compatible With: SCU-300 System Control Unit
Product Color: Black
Product Type: Cable
eClass 14 Classification Group: 40270191

3M™ PELTOR™ Cable SCU-FL030, Motorola GP340, 20 ea/Case

3M Product Number SCU-FL030 3M ID 7100228538 UPC 07318640070844

Details

Reliable connection
Ruggedized cable and connectors

Typical properties

Brands: PELTOR™
Case Quantity: 20
Compatible Radio Brands: Motorola
Compatible With: SCU-300 System Control Unit
Product Color: Black
Product Type: Cable
eClass 14 Classification Group: 40270191

3M™ Peltor™ SCU-FL001, Helicopter Low Impedance, 1 Each/Case

3M Product Number SCU-FL001 3M ID 7100227473 UPC 07318640070776

Details

Reliable connection
Ruggedized cable and connectors

Typical properties

Brands: PELTOR™
Case Quantity: 1
Compatible With: SCU-300 System Control Unit
Product Color: Black
Product Type: Cable
eClass 14 Classification Group: 40270191

3M™ PELTOR™ SCU Cable SCU-FL063, MOTOROLA MOTOTRBO, 20 Ea/Case

3M Product Number SCU-FL063 3M ID 7100228537 UPC 07318640070875

Details

Reliable connection
Ruggedized cable and connectors

Typical properties

Brands: PELTOR™
Case Quantity: 20
Compatible Radio Brands: Motorola
Compatible With: SCU-300 System Control Unit
Plug Type: Motorola TRBO
Product Color: Black
Product Type: Cable
eClass 14 Classification Group: 40270191

3M™ PELTOR™ SCU-FL009, AN/VIC 3, 20 ea/Case

3M Product Number SCU-FL009 3M ID 7100235882 UPC 07318640070837

Details

Reliable connection
Ruggedized cable and connectors

Typical properties

Brands: PELTOR™
Case Quantity: 20
Compatible With: SCU-300 System Control Unit
Product Color: Black
Product Type: Cable
eClass 14 Classification Group: 40270191

3M™ PELTOR™ Smartphone Cable SCU-FL090, 3.5 mm, 20 ea/Case

3M Product Number SCU-FL090 3M ID 7100228536 UPC 07318640070882

Details

Reliable connection
Ruggedized cable and connectors

Typical properties

Brands: PELTOR™
Case Quantity: 20
Compatible Radio Brands: 3.5mm auxiliary port
Compatible With: SCU-300 System Control Unit
Connection Type: 3.5mm Stereo
Product Color: Black
Product Type: Cable
eClass 14 Classification Group: 40270191

3M™ TEKK Protection™ Virtua™ Safety Eyewear 90525-80025T, Blue Mirror Lens

3M ID 70005088797 UPC 10078371612945

Details

Blue mirror lenses
Lightweight
Wraparound design
Meets the requirements of ANSI Z87.1-2003

Typical properties

ANSI Requirements: ANSI Z87.1-2003
Brands: 3M™
Factory ISO Certification: No ISO Certification information available
Frame Color: Blue
Lens Color: Blue
Lens Type: Mirrored
Product Type: Glasses
Project Applications: Repairing a deck, Yardwork
eCla

3M™ PELTOR™ Radio Adapter Cable FLX-001 GP900/HT1000, 1 EA/Case

3M Product Number FLX-001 3M ID 7100065594 UPC 00093045937882

Details

A patch cable that can be used to connect to a two-way radio
Compatible with the 3M™ PELTOR™ ORA TAC Headset and the WS™
ProTac™ XP Headsets
To determine the appropriate flex cable for your two-way radio, please visit
3M.com/PeltorAdapters
21" curly cable

Typical properties

Auxiliary Port: Flex
Brands: PELTOR™
Compatible Radio Brands: Alan, E.F. Johnson Technologies, Motorola
Plug Type: Motorola XTS
Product Color: Black
Product Type: Cable
Recommended Industry: Agriculture
eClass 14 Classification Group: 40270191

3M™ Flex Adaptor Cable FL6U-36

3M Product Number FL6U-36 3M ID 7000107902 UPC 07318640040052

Details

A patch cable that can be used to connect to a two-way radio
Compatible with the 3M™ PELTOR™ ORA TAC Headset and the WS™
ProTac™ XP Headsets
To determine the appropriate flex cable for your two-way radio, please visit
3M.com/PeltorAdapters
18" curly cable

Typical properties

Auxiliary Port: Flex
Brands: PELTOR™
Case Quantity: 120
Compatible Radio Brands: Kenwood
Intrinsically Safe: No
Plug Type: Kenwood two-pin
Product Color: Black
Product Type: Cable
Recommended Industry: Agriculture
eClass 14 Classification Group:

3M™ PELTOR™ FL6CE/1 3.5 mm Cable

3M ID 7000108359 UPC 07318640054929

Details

3.5mm to 3.5mm stereo connection cable
Cable with 3.5mm stereo plug
For use with select 3M™ PELTOR™ Headsets

Typical properties

Brands: PELTOR™
Compatible Radio Brands: 3.5mm auxiliary port
Product Type: Cable
eClass 14 Classification Group: 40270191

3M™ Inhalation Valve 7282, 200 EA/Case

3M Product Number 7282 3M ID 7000125986 UPC 50051138087420

Details

Approved 3M™ replacement part
Recommended for 3M Full Facepiece Respirator 7800S (sold separately)
Replacement part can extend service life of facepiece
Replaceable inhalation valve can potentially result in respiratory equipment cost savings
Valve maintains original service performance of facepiece

Typical properties

Accessories: Yes
Brands: 3M™
Case Quantity: 50/pack
Clip-on Welding Shield: Yes
Compatible with 3M™ PAPR Systems: Yes
Compatible with 3M™ Supplied Air System: Yes
Compatible with Welding Shield: No
Cool Flow™ Exhalation Valve: No
Drop-down Feature

3M™ Surgical and Specialty Masks

3M ID B00038103

Typical properties

eClass 14 Classification Group: 34150102

3M™ Exhalation Valve 7283, 50 EA/Case

3M Product Number 7283 3M ID 7000125987 UPC 50051138087437

Details

Approved 3M replacement part
Designed for 3M Full Facepiece Respirator 7800S Series (sold separately)
Replacement part can extend service life of facepiece
Replaceable part can potentially result in respiratory equipment cost savings
Valve maintains original service performance of facepiece

Typical properties

Accessories: Yes
Brands: 3M™
Case Quantity: 10/pack
Clip-on Welding Shield: Yes
Compatible with 3M™ PAPR Systems: Yes
Compatible with 3M™ Supplied Air System: Yes
Compatible with Welding Shield: No
Cool Flow™ Exhalation Valve: No
Drop-down Feature

3M™ Ratchet Kit W-3261, 1 EA/Case

3M Product Number W-3261 3M ID 7000126041 UPC 00051138291938

Details

For use with 3M™ Hoods H-Series

Typical properties

Brands: 3M™
Case Quantity: 1/case
Headgear Type: Hood
Product Color: White
Product Series: H-Series
Product Type: Ratchet Kit

3M™ 1260/1270/1271 Probed Test Plugs, 393-2016-50, 50/Case

3M ID 7100034169 UPC 10078371664838

Typical properties

Brands: 3M™

Case Quantity: 50

Material: Polyurethane

Product Color: Orange

Product Series: E-A-Rfit

Product Type: Probed Test Earplug

Recommended Application: Health & Safety Testing

eClass 14 Classification Group: 40270102

3M™ DBI-SALA® Coated Web Scaffold Choker Anchor 1201421, Polyester, 4 ft

3M Product Number 1201421 3M ID 7012816942 UPC 00840779066643

Details

Lightweight and durable polyester web construction
Meets the requirements for 29 CFR OSHA 1910.140, and OSHA 1926.502
Recommended for use in multiple industries including construction, mining, oil and gas, transportation, utilities, and wind energy
Adjustable designs available to accommodate a variety of different sized structures
Compatible with various fall arrest systems
This safety equipment is designed for use with additional personal fall arrest systems
Features high-strength steel hardware
Portable and reusable
Ideal anchorage device for scaffolding or piping

Typical properties

Attachment Type: Pass-through/Choker
Brands: DBI-SALA®
Case Quantity: 1
Connected Safety ID Equipped: No
Install Type: Reusable
Product Color: Yellow
Product Type: Coated Web Scaffold Choker
Recommended Industry: Construction, General Industrial, M

3M™ PELTOR™ Yellow LEP-200 Replacement Charging Case, 1 ea/cs

3M Product Number LEP-100C 3M ID 7100079510 UPC 00078371670719

Details

Flexible recharging of ear pieces via Micro USB and alkaline batteries
Rugged IP54 case to help protect earbuds

Typical properties

Auxiliary Port: Micro USB Charging Port
Brands: PELTOR™
Case Quantity: 1 each
Features: Level Dependent Function
Intrinsically Safe: No
Product Color: Yellow
Product Type: Case
eClass 14 Classification Group: 40270191

**3M™ E-A-R™ UltraFit™ Plugs-with-Hole Short Stem Earplugs 420-2101,
Clear, 10,000 Pair/Case**

3M Product Number 420-2101 3M ID 7010341878 UPC 50076308945775

Typical properties

Brands: E-A-R™

Case Quantity: 10000

Cord Type: None

Corded: No

Hearing Protection Style: Probed for Fit Testing

Product Type: Earplugs

Reusable: Yes

3M™ DBI-SALA® Pass-Thru Adjustable Web Tie-Off Adapter Anchor 1002105, Polyester, 5 ft

3M Product Number 1002105 3M ID 7012815110 UPC 00840779016389

Details

Lightweight and durable polyester web construction
Meets the requirements for 29 CFR OSHA 1910.140, and OSHA 1926.502
Recommended for use in multiple industries including construction, mining, oil and gas, transportation, utilities, and wind energy
Adjustable designs available to accommodate a variety of different sized structures
Compatible with various fall arrest systems
This safety equipment is designed for use with additional personal fall arrest systems
Features high-strength steel hardware
Portable and reusable
Ideal anchorage device for scaffolding or piping

Typical properties

Attachment Type: Pass-through/Choker
Brands: DBI-SALA®
Case Quantity: 1
Connected Safety ID Equipped: No
Install Type: Reusable
Product Color: Yellow
Product Type: Web Tie-Off Adaptor
Recommended Industry: Construction, General Industrial, Mining,

3M™ Black Demo Tip Foam plug-with-hole 1/2 inch height, 0.150 in hole
420-2066, 1,000 EA/Case

3M Product Number 420-2066 3M ID 7010384828 UPC 10080529191394

Details

3M PSD products are for occupational use only

*The NRR may overestimate the hearing protection provided during typical use

Typical properties

Banded: No

Brands: 3M™

Case Quantity: 1000

Corded: No

Earplug Material: Foam

Earplug Shape: Cylinder

Earplug Size: Regular

Hearing Protection Style: Probed for Fit Testing

Insertion Style: Roll Down

Product Type: Earplugs

Reusable: No

Shape: Cy

3M™ PELTOR™ ComTac™ VII 1086 SV/1, Battery Lid, 20 ea/Case

3M Product Number 1086 SV/1 3M ID 7100232689 UPC 07318640070738

Details

Rubber sealing
Easy to replace

Typical properties

Brands: PELTOR™
Compatible With: ComTac VII Headset
Product Color: Black
Product Type: Battery Cap
eClass 14 Classification Group: 40270191

3M™ PELTOR™ ComTac™ VII AL8002/1 Download Cable, 20 ea/Case

3M Product Number AL8002/1 3M ID 7100225790 UPC 07318640070769

Details

Used as a primary or back-up connection to 3M™ PELTOR™ System Control Unit, SCU-300
Ruggedized cable and connectors

Typical properties

Brands: PELTOR™
Compatible With: ComTac VII Headset, SCU-300 System Control Unit
Product Color: Black
Product Type: Cable
eClass 14 Classification Group: 40270191

3M™ Peltor™ Optime™ 95 Cap-Mount Earmuffs, Hearing Conservation H6P3E/V 10 EA/Case

3M Product Number H6P3E/V 3M ID 7000052743 UPC 10093045080653

Details

- Universal mounting attachment fits most hard hats
- Stainless steel construction resists bending and warping
- Earcup pivot points tilt for optimum comfort and efficiency
- Ultra light with liquid/foam filled earmuff cushions
- Color-coding for compliance sighting
- Noise Reduction Rating (NRR)*: 21 dB. CSA Class B

Typical properties

- Attenuation Rating: 21.0 Decibel
- Bluetooth: No
- Brands: PELTOR™
- Case Quantity: 10
- Dielectric: No
- Earmuff Style: Hard Hat Attached
- Electrically Insulated: No
- Hearing Protection Style: Hard Hat Attached
- Hearing Protection Type: cap-mount earmuffs
- Ma

3M™ DBI-SALA® Tongue Buckle Belt 1000057, Yellow, 3X

3M Product Number 1000057 3M ID 7012814955 UPC 00840779014286

Details

Body belts available in designs to be used independently, as well as other versions to be used with 3M Fall Protection Harnesses

Multiple sizes available

Meets applicable regulatory standards

Typical properties

Belly Pad: No

Belt Type: Waist

Board/Seat Cushion: No

Brands: DBI-SALA®

Buckle Material: Zinc Plated Steel

Buckle Type: Tongue Buckle

Case Quantity: 1

Connected Safety ID Equipped: Yes

Hip Pad: No

Max Free Fall Allowed: Zero (no free fall permiss

3M™ Protecta® Rope Lifeline with Carabiner AC230A1, 5/8 in Nylon, White, 100 ft

3M Product Number AC230A1 3M ID 7100188817 UPC 00648250031353

Details

- Mobile and versatile system
- Manual application
- Includes Carabiner

3M™ PELTOR™ Cable SCU-FL018, Motorola XTS1500/HT1000, 20 ea/Case

3M Product Number SCU-FL018 3M ID 7100233149 UPC 07318640070721

Details

Reliable connection
Ruggedized cable and connectors

Typical properties

Brands: PELTOR™
Case Quantity: 20
Compatible Radio Brands: Motorola
Compatible With: SCU-300 System Control Unit
Product Color: Black
Product Type: Cable
eClass 14 Classification Group: 40270191

3M™ PELTOR™ SCU-300 Cable Dust Cap DE0438/1, 20 ea/Case

3M Product Number DE0438/1 3M ID 7100228566 UPC 07318640070752

Details

Helps secure the unit
Ruggedized
Resists dust and water

Typical properties

Brands: PELTOR™
Case Quantity: 20
Compatible With: SCU-300 System Control Unit
Product Color: Black
Product Type: Dust Cap
eClass 14 Classification Group: 40270191

FUTURO™ Ultra Sheer Pantyhose for Women (French Cut)

3M ID CBGBLW011018 UPC 00051131201330

Details

Mild Compression (8-15 mm/Hg)
Helps relieve symptoms of superficial spider veins or mild varicose veins
Ideal for standing or sitting all day or active office work
Reinforced toe, heel and durable run guard for lasting wear
Graduated compression helps improve circulation
Comfort band keeps knee highs from rolling down
Silky-soft material provides a comfortable feel
Great for business casual, evening and weekend wear
Made from a comfortable blend of nylon and spandex
Size: M, L, Plus
Color: Nude

Typical properties

Body Part: Leg
Brands: FUTURO™
Factory ISO Certification: No ISO Certification information available
Material: Nylon, Spandex
Product Color: Beige, Nude
Product Type: Pantyhose
Product Usage: Achy or Tired Legs, Mild Varicose Veins, Swelling
Size:

3M™ 6023 Performance Replacement Kit OV/P95 with cartridges, filters, and retainers for the 3M™ Performance Reusable Paint Project Respirator

3M ID CBGNAW011116 UPC 00051131371507

Details

NIOSH-APPROVED 6001 OV CARTRIDGE for use against certain organic vapors

NIOSH-APPROVED 5P71 P95 filters for at least 95% filtration efficiency against solids and liquid aerosols, as well as oil-based particulates

REUSABLE 501 RETAINER attaches filter to cartridge

FOR WORKPLACE/OCCUPATIONAL USE ONLY

APPROVED FOR USE WITH 3M™ 6000, 6500 AND 7500 SERIES FACEPIECES

6001 OV CARTRIDGE HELPS REDUCE EXPOSURE to certain organic vapors encountered during activities involving latex and oil-based painting, including paint spraying*, varnishes, stains, sealants, solvents, certain solvent-based cleaners or pesticides**. *Use a prefilter when spraying **Refer to Pesticide Product Label for Respirator Guidance or call 3M at 1-800-243-4630 or In Canada, call 1-800-267-4414

5P71 FILTER HELPS REDUCE EXPOSURE to certain particles from paint spraying*, spray adhesives and pesticides**. *Use a prefilter when spraying **Refer to Pesticide Product Label for Respirator Guidance or call 3M at 1-800-243-4630 or In Canada, call 1-800-267-4414

EASY-TO-ATTACH DESIGN

Facepiece is not included

Label Color: Black

KIT CONTENTS: one pair of replaceable 6001 cartridges, one pair of reusable 501 retainers and two pairs of replaceable 5P71 filters

WARNING: Workplace/Occupational Applications: This respirator helps protect against certain airborne contaminants. Misuse may result in sickness or death. For correct use, consult supervisor and User Instructions, or call 3M in USA at 1-800-243-4630. In Canada, call 1-800-267-4414

Typical properties

Cartridge or Filter Included: Yes

Cartridge or Filter Type: Combination

Case Quantity: 5 Packs/Case

Catalog Number: 6023P1-DC-THD,6023P1-DC

Clip-on Welding Shield: No

Compatible with 3M™ PAPR Systems: No

Compatible with 3M™ Supplied Air System: No

Dimensions and Classifications

Overall Height (Imperial): 6.88 in

Overall Height (Metric): 17.4625 cm

Overall Length (Imperial): 4.38 in

Overall Length (Metric): 11.1125 cm
Overall Width (Imperial): 2.88 in
Overall Width (Metric): 7.3025 cm

3M™ Disposable Classic Earplugs

3M ID CBGNAW011163 UPC 00078371905811

Details

Pliable design slowly expands, conforming to your ear canal to help block out hazardous noise

Soft, smooth design enhances comfort for longer wear

Easy to insert and remove

Expands slowly to fit a wide range of ear canal sizes

Highly visible colors for easy location on a busy jobsite

Great for use with additional ear protection like earmuffs

Noise Reduction Rating (NRR) 29 dB*

Helps protect against harmful noises that are at 85 dB and above

Convenient, disposable design

Available in multiple colors and quantities

Color: Orange

Package contents: 4 pairs/pack

Typical properties

Attenuation Rating: 29.0 Decibel

Factory ISO Certification: No ISO Certification information available

Product Type: Earplugs

Project Applications: Installing Flooring and Trim, Laying tile, Refinishing Floors, Refinishing Woodwork, Remodeling a bathro

Peltor™ Sport Shotgunner™ II Low-Profile Hearing Protector, 24 NRR Black/Gray

3M ID CBGNARUS2506 UPC 00051125005647

Details

- Low-profile cups with cut-outs are ideal for use with rifles and shotguns
- Foldable for storage, protection and portability
- Lightweight and comfortable for extended wear
- Fully adjustable headband ergonomically engineered to reduce pressure points
- Soft, conformable rings provide a better seal
- Stylish, two-color design

Typical properties

- Attenuation Rating: 24.0 Decibel
- Catalog Number: 97040-PEL-6C,97040-PEL-2C
- Factory ISO Certification: No ISO Certification information available
- Product Type: Earmuff
- Project Applications: DIY and Professional, Installing Flooring and Trim, Laying til

3M™ Safety Eyewear Polarized, 90214-HZ4-NA, Blk Frame, AF & Scratch Resistant Lens, 4/cs

3M ID 70006984846 UPC 00638060081402

Details

Durable lenses help provide limited protection from light to moderate impact hazards

Lightweight, durable design for comfort and lasting use

Scratch-resistant lenses help keep vision clear

Impact-resistant lenses block 99.9% of UV rays

Includes a handy storage bag and lanyard to help prevent damage and loss

Meets the requirements of ANSI Z87.1, CSA Z94.3 and AS/NZS 1337

Polarized lenses help reduce glare and are popular for inside and outside environments

Typical properties

Brands: 3M™

Catalog Number: 90214-HZ4-NA

Factory ISO Certification: No ISO Certification information available

Frame Material: Polycarbonate

Frame Style: Wraparound

Product Type: Safety Glasses

Sealed Eyewear: No

Splash Protection: No

Standards an

Dimensions and Classifications

Overall Height (Imperial): 8 in

Overall Height (Metric): 203.2 mm

Overall Length (Imperial): 3.8 in

Overall Length (Metric): 96.52 mm

Overall Width (Imperial): 6 in

Overall Width (Metric): 152.4 mm

FUTURO™ Anti-Embolism Stockings Knee Length, Closed Toe

3M ID CBGBLW011013 UPC 00051131201620

Details

Moderate Compression (18 mm/Hg)

Soft, durable materials provide lasting comfort and a stay-put fit

Graduated compression helps accelerate blood flow up the leg

Helps reduce the formation of blood clots

For use in post-surgery recovery

Made from a comfortable blend of nylon and spandex

Size: M, L, XL

Color: White

Typical properties

Body Part: Leg

Brands: FUTURO™

Compression Level: Moderate

Condition: Post Surgery

Factory ISO Certification: No ISO Certification information available

Material: Nylon, Spandex

Product Color: White

Product Type: Knee Length Stocking

Product Usage

FUTURO™ Open Toe Knee Length Stockings

3M ID CBGBLW011025 UPC 00051131201064

Details

Firm Compression (20-30 mm/Hg)

Vein therapy helps relieve symptoms of moderate-to-severe varicose veins and ankle swelling

Ideal for standing or sitting all day, traveling or active office work

Can be used for supportive comfort during post-surgery recovery

Open-toe design has a smooth, comfortable finish

Graduated compression helps improve circulation

Massages tired or achy legs as you move

Materials are soft, smooth and soothing

Knee length for enhanced coverage

Reinforced heel for durability

Made from a comfortable blend of nylon and spandex

Size: S, M, L, XL

Color: Beige

Typical properties

Body Part: Leg

Brands: FUTURO™

Colors Available: Beige

Compression Level: Firm

Condition: Achy or Tired Legs, Chronic Leg Fatigue or Heaviness, Moderate

Varicose Veins or Swelling, Moderate/Severe Leg Pain

Factory ISO Certification: No ISO Certificat

Peltor™ Sport Tactical 500 Electronic Hearing Protector, TAC500-OTH, 1 Hearing Protector, 4/Case

3M ID 70006968831 UPC 00076308913373

Details

NRR: 26 dB noise reduction rating

IDEAL FOR both indoor and outdoor shooters and hunters

BLUETOOTH™ TECHNOLOGY to stream music and make calls

DYNAMIC SUPPRESSION TIME measures the energy in gunshot noise and automatically sets suppression time for reduced echoes and increased comfort

CLEAR VOICE TRACKING seeks voice within background noise and actively filters noise for improved speech intelligibility

DURABLE RECESSED MICROPHONES prevent damage and reduce wind noise

RUNS ON 2 AA batteries (not included) or Alpha 1100 lithium ion rechargeable battery (sold separately)

Low-profile cups have cut-outs for use with long guns`

Vented, adjustable headband improves comfort when worn with hats

Durable recessed microphones designed to reduce wind and fan noise

Typical properties

Battery Type: Disposable AA, Lithium-ion Rechargeable

Brands: PELTOR™

Catalog Number: TAC500-OTH

Factory ISO Certification: No ISO Certification information available

eClass 14 Classification Group: 40270191

Peltor™ Sport Over The Glass Safety Eyewear 47030-PEL-6, Clear, 6/Case

3M ID 70006953866 UPC 00076308730024

Details

- Fits well over most prescription eyewear
- Built-in side shields provide front and side protection
- Clear lens, best for indoor applications or for outdoors when glare is not a factor
- Meets the requirements of ANSI Z87.1-2010
- High impact-resistant lenses
- Lenses absorb up to 99.9% UV
- Wash lenses in warm water and let air dry or dry with soft cloth
- Contains: 1 Over-the-Glass Safety Eyewear

Typical properties

- Brands: PELTOR™
- Catalog Number: 47030-PEL-6
- Factory ISO Certification: No ISO Certification information available
- Frame Material: Polycarbonate
- Material: Polycarbonate
- eClass 14 Classification Group: 40230101

3M™ WorkTunes™ Connect Wireless Hearing Protector

3M ID CBGNAWUS1754 UPC 00076308913267

Details

NRR of 24 dB (Noise Reduction Rating)*

BLUETOOTH® TECHNOLOGY lets you seamlessly stream entertainment from your mobile phone and any other Bluetooth® enabled device

HIGH-FIDELITY SPEAKERS provide premium sound quality

INTEGRATED MICROPHONE lets you make and take phone calls without removing the hearing protection

CORD AND ANTENNA-FREE design lets you move easily on the job

SIMPLE SINGLE-BUTTON INTERFACE allows you to stay focused on the job

AUDIO ASSIST TECHNOLOGY provides operational and set-up guidance—without having to take off the hearing protector

FLEXIBLE HEADBAND with cutouts to improve comfort when worn with caps

LIGHTWEIGHT, LOW-PROFILE DESIGN is great for extended wear

*CAUTION: 3M strongly recommends fit testing of hearing protectors. Research suggests that many users will receive less noise reduction than indicated by the NRR due to variation in hearing protector fit, fitting skill and motivation of the user. If the NRR is used, 3M recommends that it be reduced by 50% or in accordance with applicable regulations

SOFT, CONFORMABLE EAR CUSHIONS and low-profile cups for a comfortable fit

AUTO SHUT-OFF feature with low-battery indicator

BUILT-IN RECHARGEABLE BATTERY; charging cord included

COMPATIBLE WITH NON-BLUETOOTH DEVICES via 3.5m audio cable (not included)

30+ HOURS OF BATTERY LIFE PER CHARGE

Typical properties

ANSI Requirements: NRR 24dB

Audio Type: Communication, Music/Entertainment

Battery Type: Lithium-Ion

Bluetooth: Yes

Built In FM and or AM Radio: No

Built in 2-Way Radio: No

Catalog Number: 90543H1-DC-PS

Communication Direction: Two-way

Communicati

Dimensions and Classifications

Overall Height (Imperial): 7.05 in

Overall Height (Metric): 17.9 cm

Overall Length (Imperial): 5.87 in

Overall Length (Metric): 14.9 cm

Overall Width (Metric): 9.9 cm

3M™ Welding Valved Respirator 8515HA1-A-PS 1 ea/pk, 12 pks/cs

3M ID 70006963352 UPC 00051131800243

Details

NIOSH-APPROVED N95 for at least 95 percent filtration efficiency against certain non-oil-based particles and aerosols
FOR WORKPLACE/OCCUPATIONAL USE ONLY
3M™ COOL FLOW™ VALVE helps reduce heat build-up inside the respirator
ADVANCED FILTER MEDIA for easy breathing
FLAME-RESISTANT Filter material is designed to be flame resistant
STRETCHABLE, BRAIDED HEADBANDS
ADJUSTABLE M-NOSECLIP helps ensure a custom, secure seal with fewer pressure points
LIGHTWEIGHT DESIGN for comfort
COMFORTABLE for long periods of wear
CONVENIENT, DISPOSABLE DESIGN
RECOMMENDED FOR welding, soldering, metal sanding and grinding particulates
AN ECONOMICAL OPTION for welders and metalworkers
Contains no components made from natural rubber latex
Package contents: 1
DIY/Home Use: Use ONLY in NON-HARMFUL environments.
Occupational/Hazardous Use: Use under a government regulated (e.g. OSHA) respiratory protection program. WARNING: Limitations apply; Misuse may result in sickness or death. See product packaging and insert or call 3M in USA at 1-800-243-4630. In Canada, call 1-800-267-4414

Typical properties

Brands: 3M™
Exhalation Valve: Yes
Factory ISO Certification: No ISO Certification information available
Filter Class: N95
Registered Medical Device: No
Respirator Size: Standard
Specifications Met: Assigned Protection Factor (ADF) = 10
eClass 14 CI

3M™ Disposable Earplugs

3M ID CBGNAW011196 UPC 00051141333533

Details

Pliable design slowly expands, conforming to your ear canal to help block out hazardous noise

Soft, smooth design enhances comfort for longer wear

Easy to insert and remove

Expands slowly to fit a wide range of ear canal sizes

Highly visible colors for easy location on a busy jobsite

Great for use with additional ear protection like earmuffs

Noise Reduction Rating (NRR) 32 dB*

Helps protect against harmful noises

Convenient, disposable design

Available in multiple colors and quantities

*CAUTION: 3M strongly recommends fit testing of hearing protectors. Research suggests that many users will receive less noise reduction than indicated by the NRR due to variation in hearing protector fit, fitting skill and motivation of the user. If the NRR is used, 3M recommends that it be reduced by 50% or in accordance with applicable regulations

Typical properties

Attenuation Rating: 32.0 Decibel

Banded: No

Catalog Number: 92800-LG80-6DC,92050H4-DC,92050H4-C

Cord Type: None

Corded: No

Earplug Color: Assorted, Orange

Earplug Material: Foam

Earplug Shape: Round

Earplug Size: One Size Fits Most

Factory ISO Ce

Dimensions and Classifications

Overall Height (Imperial): 5.5 in

Overall Height (Metric): 13.97 cm

Overall Length (Imperial): 0.8 in

Overall Length (Metric): 2.032 cm

Overall Width (Imperial): 4 in

Overall Width (Metric): 10.16 cm

3M™ WorkTunes™ Connect + Gel Cushions Hearing Protector with Bluetooth® technology

3M ID CBGNAWUS1817 UPC 00638060278130

Details

Exclusive to Amazon

Gel ear cushions are soft and conformable for enhanced comfort

Bluetooth® technology lets you seamlessly stream entertainment from your mobile phone and any other Bluetooth® enabled device

High-fidelity speakers provide premium sound quality

Integrated microphone lets you make and take phone calls without removing the hearing protection

Cord and antenna-free design lets you move easily on the job

Simple single-button interface is easy to use with gloves

Audio Assist Technology provides operational and set-up guidance—without having to take off the hearing protector

Flexible headband with cutouts to improve comfort when worn with caps

Lightweight, low-profile design is great for extended wear

Auto shut-off feature with low-battery indicator. Built-in rechargeable battery; charging cord included

Compatible with non-Bluetooth devices via 3.5m audio cable (not included)

Makes an excellent gift for the yard or woodworking enthusiast

AC charging adaptor not included; device-compatible with standard USB chargers using supplied Micro USB cable

Noise Reduction Rating (NRR) of 23 dB

Typical properties

Audio Type: Communication

Battery Type: Lithium-Ion

Catalog Number: 90544-SIOC

Communication Direction: Two-way

Connection Type: Wireless

Connector Size (Metric): 3.5 mm

Factory ISO Certification: No ISO Certification information available

Hearing

FUTURO™ Opaque Tights

3M ID CBGBLRUS1517 UPC 00051131215054

Details

Moderate Compression (15-20 mm/Hg)
Comfortable support to help promote healthy legs
Helps improve circulation, relieve swollen ankles and tired, achy legs
Great for Travel
Great for Being on Your Feet All Day
Helps prevent deep vein thrombosis (DVT)
Comfortable panty with knit-in waistband for all day comfort
Soft, silky microfiber nylon
Size M, L
Color: Black

Typical properties

Body Part: Leg
Brands: FUTURO™
Factory ISO Certification: No ISO Certification information available
Material: Nylon, Spandex
Product Color: Black
Size: Large, Medium
Sizes Available: Medium, Large
Support Level: Moderate
Support and Compression Le

3M™ Kids Hearing Protection PKIDSB-BLU, Blue, 4 ea/case

3M ID 70009119481 UPC 00638060661789

Details

Helps protect your kids' hearing, so you can enjoy loud outdoor activities together
Creates a quiet environment for studying, reading or relaxing in shared indoor spaces

Premium hearing protection from a trusted brand in professional safety

22 dB NRR (Noise Reduction Rating)/ANSI S3.19-1974 Certified

Padded ear cushions conform around the ears for long-lasting comfort

Flexible headband provides a secure (but not too tight) fit

Adjustable — keep using it as your child grows

Conveniently folds up into a compact size so it's always there when you need it

Kid-friendly design comes in a variety of fun colors that kids will want to wear

Typical properties

Brands: 3M™

Catalog Number: PKIDSB-BLU

Factory ISO Certification: No ISO Certification information available

eClass 14 Classification Group: 40270191

Peltor™ Sport Tri-Flange™ Corded Reusable Earplugs 97317-10C, 3 Pair Pack Neon Yellow

3M ID 70006944956 UPC 00078371610067

Details

NRR 26 dB

Triple-flange design for snug, comfortable fit

Washable and corded

Cord helps reduce the chance of loss when not in use

3-pair pack includes storage container to help keep plugs clean when not being worn

Made in U.S.A. Cord attached in Mexico

Typical properties

Brands: PELTOR™

Catalog Number: 97317-10C

Factory ISO Certification: No ISO Certification information available

eClass 14 Classification Group: 40270190

3M™ WorkTunes™ Connect + AM/FM Hearing Protector

3M ID CBGNARUS2453 UPC 00076308726539

Details

Noise Reduction Rating (NRR) 24 dB*

BLUETOOTH® WIRELESS TECHNOLOGY lets you seamlessly stream entertainment from your mobile phone and any other Bluetooth® enabled device
INTEGRATED MICROPHONE lets you make and take phone calls without removing the ear protection

EXCELLENT AM/FM RADIO performance with clear sound and bass boost option for great listening

AUDIO ASSIST TECHNOLOGY provides operational and set-up guidance—without having to take off the headset

AUDIO ASSIST TECHNOLOGY helps you program up to 50 AM/FM radio stations and lets you know when your battery is running low

EASY-TO-USE CONTROLS are conveniently within reach on your headset
Volume temporarily mutes when phone calls and messages are received

For optimal performance, stay within 25 feet of your Bluetooth® enabled device

Standard 3.5mm audio input jack lets you connect your devices

Makes an excellent gift for the yard or woodworking enthusiast

*CAUTION: 3M strongly recommends fit testing of hearing protectors. Research suggests that many users will receive less noise reduction than indicated by the NRR due to variation in hearing protector fit, fitting skill and motivation of the user. If the NRR is used, 3M recommends that it be reduced by 50% or in accordance with applicable regulations

For optimal performance, stay within 25 feet of your Bluetooth® enabled device

Standard audio input jack lets you connect your devices

Optional lithium rechargeable battery (sold separately) – model number 3M Alpha1100

Typical properties

ANSI Requirements: NRR 24dB

Audio Type: Communication, Music/Entertainment

Battery Life: 8 hr

Bluetooth: Yes

Built In FM and or AM Radio: Yes

Built in 2-Way Radio: No

Catalog Number: 90542-3DC,90542H1-DC-PS

Communication Direction: Two-way

Communi

Dimensions and Classifications

Overall Height (Imperial): 8.46 in

Overall Height (Metric): 21.5 cm

Overall Length (Imperial): 3.98 in

Overall Length (Metric): 10.1 cm

Overall Width (Metric): 17.9 cm

3M™ Anti-Fog Goggle with Scotchgard™ Protector 47211H1-VDC, Black/Blue, Gray Lens

3M ID 70009111124 UPC 00638060280775

Details

Give you and your crew the essential protection and undeniable style of 3M™ Performance Eyewear
PREMIUM ANTI-FOG COATING to help you see clearly for longer
DURABLE LENSES help provide limited protection from light to moderate impact hazards
LIGHTWEIGHT, durable design for comfort and lasting use
DESIGNED FOR WORKING in challenging situations such as heat and humidity, indoor, outdoor and climate-controlled areas
COMPATIBLE with many types of additional Personal Protection Equipment (PPE)
SOFT TOUCH nose pads and earpiece enhance comfort
SCRATCH RESISTANT lenses help keep vision clear
IMPACT RESISTANT LENSES block 99.9% of UV rays
Meets the requirements of ANSI Z87.1 , CSA Z94.3 and AS/NZS 1337
GRAY LENSES help reduce sunlight and are popular for outdoor use

Typical properties

Brands: 3M™
Catalog Number: 47211H1-VDC-PS
Factory ISO Certification: No ISO Certification information available
Frame Material: Polycarbonate
Frame Style: Wraparound
Sealed Eyewear: No
Splash Protection: No
Standards and Specifications: AS/NZS 133

Dimensions and Classifications

Overall Height (Imperial): 8.5 in
Overall Height (Metric): 215.9 mm
Overall Length (Imperial): 2.75 in
Overall Length (Metric): 69.85 mm
Overall Width (Imperial): 5.5 in
Overall Width (Metric): 139.7 mm

Peltor™ Sport SecureFit™ Safety Eyewear SF400-PC-9, Clear/AF Lens, 9 ea/cs

3M ID CBGBLRUS1535 UPC 00638060267219

Details

Durable lenses help provide limited protection from light to moderate impact hazards
3M™ Pressure Diffusion Temple self-adjusts to provide a secure, comfortable fit
Padded temples for added comfort over the ears
Soft, conformable nose pads provide customizable comfort
Lightweight, durable design for all-day comfort and lasting wear
Sleek temples create a flush fit with ear protection
Flexible temples conform comfortably to different head sizes
Anti-fog, scratch-resistant lenses help keep vision clear
Impact-resistant lenses block 99.9% of UV rays
Meets the requirements of ANSI Z87.1, CSA Z94.3 and AS/NZS 1337
Clear lenses help provide excellent visibility and can be used indoors or outdoors

Typical properties

Catalog Number: SF400-PC-9
Factory ISO Certification: No ISO Certification information available
Frame Color: Black and Green
Lens Color: Clear
Material: Polycarbonate
eClass 14 Classification Group: 40230101

FUTURO™ Anti-Embolism Thigh Length Stockings

3M ID CBGBLW011014 UPC 00051131201675

Details

Helps reduce the formation of blood clots
Designed for the recuperating patient
Soft, durable materials for outstanding comfort and fit
Graduated compression knitting technology accelerates blood flow up the leg
For use in post-surgery recovery
Made from a comfortable blend of nylon and spandex
Size: M Short, M Regular, and L Regular
Color: White

Typical properties

Body Part: Leg
Brands: FUTURO™
Colors Available: White
Compression Level: Moderate
Condition: Post Surgery
Factory ISO Certification: No ISO Certification information available
Material: Nylon, Spandex
Product Color: White
Product Type: Thigh Leng

FUTURO™ Open Toe/Open Heel Knee Length Stocking

3M ID CBGBLW011026 UPC 00051131201095

Details

Firm Compression (20-30 mm/Hg)
Ideal for standing or sitting all day, or active office work
Can be used for supportive comfort during post-surgery recovery
Open toe and heel have a smooth, comfortable finish
Graduated compression helps improve circulation
Massages tired or achy legs as you move
Materials are soft, smooth and soothing
Knee length for enhanced coverage
Made from a comfortable blend of cotton, polyester and natural rubber latex
Size: M, L, XL
Color: Beige

Typical properties

Body Part: Leg
Brands: FUTURO™
Compression Level: Firm
Factory ISO Certification: No ISO Certification information available
Foot Style: Open Toe
Material: Cotton, Natural Rubber Latex, Polyester
Product Color: Beige
Product Type: Knee Length with

Peltor™ Sport SecureFit™ 400 Eye Protection SF400-P3PK-6, 3 Pack: Clear + Amber + Gray Lenses, Anti Fog

3M ID 70006945193 UPC 00051141995090

Details

3-pack of multi-shaded lenses: Clear, Amber, Gray
Low profile, flexible temples provide comfort when worn with hearing protection
High impact-resistant lenses absorb up to 99.% UV
Lightweight and flexible for a secure and comfortable fit

Typical properties

ANSI Requirements: ANSI Z87.1-2010
Brands: PELTOR™
Factory ISO Certification: No ISO Certification information available
Frame Color: Black
eClass 14 Classification Group: 40230101

3M™ Anti-Fog Goggle with Scotchgard™ Protector 47212H1-VDC, Gray/Red, Clear Lens, 5/cs

3M ID 70009110340 UPC 00638060279625

Details

Give you and your crew the essential protection and undeniable style of 3M™ Performance Eyewear
PREMIUM ANTI-FOG COATING to help you see clearly for longer
DURABLE LENSES help provide limited protection from light to moderate impact hazards
LIGHTWEIGHT, durable design for comfort and lasting use
DESIGNED FOR WORKING in challenging situations such as heat and humidity, indoor, outdoor and climate-controlled areas
COMPATIBLE with many types of additional Personal Protection Equipment (PPE)
SOFT TOUCH nose pads and earpiece enhance comfort
SCRATCH RESISTANT lenses help keep vision clear
IMPACT RESISTANT LENSES block 99.9% of UV rays
Meets the requirements of ANSI Z87.1 , CSA Z94.3 and AS/NZS 1337
CLEAR LENSES help provide excellent visibility and can be used indoors or outdoors

Typical properties

Brands: 3M™
Catalog Number: 47212H1-VDC-PS
Factory ISO Certification: No ISO Certification information available
Frame Material: Polycarbonate
Frame Style: Wraparound
Sealed Eyewear: No
Splash Protection: Yes
Standards and Specifications: AS/NZS 13

Dimensions and Classifications

Overall Height (Imperial): 8.5 in
Overall Height (Metric): 215.9 mm
Overall Length (Imperial): 2.8 in
Overall Length (Metric): 71.12 mm
Overall Width (Imperial): 5.5 in
Overall Width (Metric): 139.7 mm

3M™ Perfect-It™ Paint Finishing Apron

3M ID B40069503

Details

Protects shop clothes and equipment from paint spray, dirt, dust and swarf
Durable, washable cloth construction delivers comfort and value
Double pouch pockets on front let you keep tools and other supplies handy
Carries large 3M logo and Perfect-It™ Paint Finishing System branding, building customer trust

Typical properties

Brands: Perfect-it™

3M™ Scotchlite™ Reflective Material 8987 Series

Details

3M™ Scotchlite™ Reflective Material is designed for enhancing visibility in low light and nighttime conditions
Certified to various flame resistant standards such as NFPA
Fluorescent properties help to make material highly visible in daylight, dawn and dusk
Sew-on application

Typical properties

Adhesive: None
Attachment Type: Sew On
Backing: None
Backing Material: Flame Retardant Cotton
Brands: Scotchlite™
Certified Performance Required: NFPA, None
Daytime Color: Fluorescent Lime-Yellow
Flame Resistant: Yes
Home Wash Cycles 60°C (140°F)

Dimensions and Classifications

Overall Length (Imperial): 54.68 yd, 109.36 yd, 218.72 yd
Overall Length (Metric): 50 m, 100 m, 200 m
Overall Width (Imperial): 1 in, 2 in, 3 in, 36 in
Overall Width (Metric): 25.4 mm, 50.8 mm, 76.2 mm, 914.4 mm

3M™ PELTOR™ LiteCom FRS Headset MT53H7B4602-NA, Neckband, 10 ea/Case

3M Product Number MT53H7B4602-NA 3M ID 7100204441 UPC 07318640069671

Details

Protective communication solution for hands-free, clear communication in noisy environments

Helps provide hearing protection when exposed to hazardous noise

Analog two-way communication radio with 22 pre-programmed FRS channels

Noise-cancelling microphone for clear speech transmission in noisy environments

Push-to-Talk (PTT) or hands-free Voice Operated (VOX) transmit options

Operates on AA batteries or rechargeable NiMH battery pack

Voice guided headset menu for easy operation

Built tough for the working professional

Comfortable for all day wearability

Typical properties

Attenuation Rating: 25 dB

Audio Type: Communication

Auxiliary Port: J22

Battery Life: Approx. 20 hours

Battery Type: AA or Rechargeable NiMH Pack, Disposable AA

Bluetooth: No

Brands: PELTOR™

Built in 2-Way Radio: Yes

CSA Class: CSA Class A

Commun

3M™ PELTOR™ LiteCom FRS Headset MT53H7A4602-NA, Headband, 10 ea/Case

3M Product Number MT53H7A4602-NA 3M ID 7100204442 UPC 07318640069664

Details

Protective communication solution for hands-free, clear communication in noisy environments

Helps provide hearing protection when exposed to hazardous noise

Analog two-way communication radio with 22 pre-programmed FRS channels

Noise-cancelling microphone for clear speech transmission in noisy environments

Push-to-Talk (PTT) or hands-free Voice Operated (VOX) transmit options

Operates on AA batteries or rechargeable NiMH battery pack

Voice guided headset menu for easy operation

Built tough for the working professional

Comfortable for all day wearability

Typical properties

Attenuation Rating: 25 dB

Audio Type: Communication

Auxiliary Port: J22

Battery Life: Approx. 20 hours

Battery Type: AA or Rechargeable NiMH Pack, Disposable AA

Bluetooth: No

Brands: PELTOR™

Built in 2-Way Radio: Yes

CSA Class: CSA Class B

Commun

3M™ VIRTUA™ CCS Protective Eyewear Replacement Foam Gasket VCRG1, 10 ea/Case

3M Product Number VCRG1 3M ID 7010316613 UPC 50051141567902

Details

These foam gaskets can be used to replace the foam gasket on 3M™ Virtua™ CCS with Foam Gasket spectacles
Foam gasket is removable for alternative wear configurations
Foam gasket features a comfortable seal between the frame and face
Foam gasket helps limit eye exposure to nuisance dust while providing additional cushioning

Typical properties

Brands: Virtua™
For Use With: 3M™ Virtua™ CCS Protective Eyewear
Material: Foam
Product Series: CCS
Product Type: Gasket
eClass 14 Classification Group: 40230191

3M™ SecureFit™ 500 Series SF500-FOAM, Replacement Foam Gasket, 10 ea/bag, 12 bags/Case

3M Product Number SF500FOAM 3M ID 7100239114 UPC 50638060430731

Details

Designed for use with SecureFit™ 500 Series Safety Glasses
Removable foam-lined gasket helps limit eye exposure to dirt and debris
Easily remove for cleaning or alternate wearing configurations
Provides added comfort and cushioning

Typical properties

Brands: SecureFit™
Case Quantity: 120
For Use With: 3M™ SecureFit™ 500 Series Protective Eyewear
Material: Foam
Product Series: 500
Product Type: Gasket
Recommended Application: Assembly, Automotive, Aviation, Chemical Handling, Chemicals, Chiseling

3M™ Solus™ 2000 Series S2000-FOAM Replacement Foam Gasket, 10PK, 12 pack/Case

Part Number S2000-FOAM 3M Product Number S2000-FOAM 3M ID 7100223280

Details

Removable foam-lined gasket helps limit eye exposure to dirt and debris while providing added comfort and cushioning. Easily removed for cleaning or alternate wearing configurations

Small vents in the optional gasket help minimize fogging

Typical properties

Brands: Solus™

Case Quantity: 10

Comfort Features: Contains Foam Gasket

For Use With: 3M™ Solus™ 2000 Series Protective Eyewear

Material: Foam

Product Series: 2000

Product Type: Gasket

Recommended Application: Assembly, Automotive, Aviation, Chemic

3M™ PELTOR™ Flexible Boom Speech Microphone, MT33/1, 1 EA/CS

Part Number MT33/1 3M Product Number MT33/1 3M ID 7100112093

Details

For use with select 3M™ PELTOR™ Headsets for reliable and clear communication in noise
Ruggedized for use in challenging weather conditions
Fully adjustable flexible boom allows for easy movement and individualized placement
Water and dust-proof (IP68)

Typical properties

Brands: PELTOR™
Case Quantity: 1 EA/CS
External Audio Input: No
Intrinsically Safe: No
Microphone Class/Type: Dynamic
Plug Type: J22
Product Color: Black
Product Series: Accessory
Product Type: Microphone
eClass 14 Classification Group: 40270191

3M™ PELTOR™ Flexible Dynamic Boom Microphone

3M Product Number MT33-05R 3M ID 7100157305 UPC 00093045938230

Details

This noise cancelling mic is primarily used on 3M™ PELTOR™ Comtac™ two-way tactical communication headsets
Compatible with select PELTOR branded headsets

Typical properties

Brands: PELTOR™
Product Type: Microphone
eClass 14 Classification Group: 40270191

3M™ PELTOR™ Boom Microphone MT53V/1, 20 ea/Case

3M Product Number MT53V/1 3M ID 7100098955 UPC 07318640067028

Details

Noise-cancelling microphone for clear communication in noisy environments
For use with the 3M™ Versaflo™ M-300 Series Hard Hat
Compatible with 3M™ PELTOR™ Headsets that have a 3M Product Number starting with MT53 or MRX21
Microphone includes three adjustment points to fit to a wide range of head sizes
Easily snaps into the rim of the hard hat
Hard hat attachment plates are included for the assembly of a 3M™ PELTOR™ Headset to the hard hat
This accessory is included in the NIOSH approvals for M-300 series configurations

Typical properties

Brands: PELTOR™
Built In FM and or AM Radio: No
Built in 2-Way Radio: No
Case Quantity: 20
Connection Type: Wired
Hearing Protection Style: Hard Hats
Hearing Protection Type: Hard Hat Attached
Intrinsically Safe: No
Microphone Class/Type: Electret

3M™ PELTOR™ Boom Microphone MT7V/1, 20 ea/Case

3M Product Number MT7V/1 3M ID 7100099097 UPC 07318640067035

Details

Noise-cancelling microphone for clear communication in noisy environments
For use with the 3M™ Versaflo™ M-300 Series Hard Hat
Compatible with most 3M™ PELTOR™ Headsets that have a 3M Product Number starting with MT7 (not compatible with CH-3 headsets)
Microphone includes three adjustment points to fit to a wide range of head sizes
Easily snaps into the rim of the hard hat
Hard hat attachment plates are included for the assembly of a 3M™ PELTOR™ Headset to the hard hat
This accessory is included in the NIOSH approvals for M-300 series configurations

Typical properties

Brands: PELTOR™
Built In FM and or AM Radio: No
Built in 2-Way Radio: No
Case Quantity: 20
Connection Type: Wired
Hearing Protection Style: Hard Hats
Hearing Protection Type: Hard Hat Attached
Intrinsically Safe: No
Microphone Class/Type: Dynamic

3M™ PELTOR™ Flexible Boom Speech Microphone MT34/1, 10 ea/Case

3M Product Number MT34/1 3M ID 7100231592 UPC 07318640071292

Details

For use with the 3M™ PELTOR™ WS™ LiteCom Pro III Headsets for reliable and clear communication in noise
Connects directly to internal PCB
Includes a grommet on the cable to secure the cable to the earcup
Ruggedized for use in challenging weather conditions
Fully adjustable flexible boom allows for easy movement and individualized placement
Water and dust-proof (IP68)

Typical properties

Brands: PELTOR™
Case Quantity: 10
Intrinsically Safe: No
Microphone Class/Type: Dynamic
Plug Type: PCB
Product Color: Black
Product Type: Microphone
Specifications Met: IP68
eClass 14 Classification Group: 40270191

1173 SV/1 BATTERY COVER BLACK PIN PACK

3M Product Number 1173 SV 3M ID 7000039640

Details

Replacement battery cover for the 3M™ PELTOR™ TacticalPRO, PowerCom, and PowerCom Plus Headsets
1 EA/Case

Typical properties

Brands: PELTOR™
Product Color: Black
Product Type: Battery
Purpose: Exclude
eClass 14 Classification Group: 40270191

3M™ PELTOR™ Triple-C Communicaiton Eartips CCC-GRM-25, 25 Pair/Case

3M Product Number CCC-GRM-25 3M ID 7100103087 UPC 10078371670587

Details

No-Roll-Down, Double-tapered shape for easy insertion
Specially formulated soft foam for extended wear
Hearing Protection and In-Ear Communciation in noisy environments
Flexible, molded sound channel for clear communication

Typical properties

Brands: PELTOR™
Case Quantity: 25
Product Color: Gray
Product Type: Eartip
eClass 14 Classification Group: 40270191

3M™ Scotchlite™ Reflective Material 9920 Series

Details

Compliant brightness designed for enhancing visibility of wearer in low light and nighttime conditions

Certified to various global high visibility standards such as ANSI/ISEA 107

Suitable for applications that will be exposed to industrial laundering

Bonded to 100% polyester fabric

Sew-on application

Printed with 3M trademarks for easy identification

For use on safety garments, athletic wear, and casual wear

Typical properties

Adhesive: None

Attachment Type: Sew On

Backing: None

Backing Material: Polyester

Brands: Scotchlite™

Certified Performance Required: ANSI 107-2015, CSA Z95-2015, Oeko-Tex

Daytime Color: Silver

Dry-Cleaning Cycles at ANSI Certified Standards: 50

Dr

Dimensions and Classifications

Overall Length (Imperial): 54.68 yd, 109.36 yd, 218.72 yd, 437.45 yd

Overall Length (Metric): 50 m, 100 m, 200 m, 400 m

Overall Width (Imperial): 0.5 in, 1 in, 1.5 in, 2 in, 3 in, 50 in

Overall Width (Metric): 12.7 mm, 19.05 mm, 25.4 mm, 38.1 mm, 50.8

3M™ PELTOR™ Tactical Sport™ MT16H210F-479-SV, Electronic Headset, Foldable Headband, Black, 10 Each/Case

3M Product Number MT16H210F-479-SV 3M ID 7000108437 UPC 07318640045286

Details

A premier hearing protection and communication solution for high noise environments

Great for hunters and shooters

Environmental microphones allow face-to-face conversation and improved situational awareness in quiet and low-to-moderate levels of noise

Foam and liquid-filled cushions provide lasting comfort and an effective acoustic seal for long duration wear times

Foldable, adjustable headband provides a comfortable and secure fit, and folds over the earcups for compact storage

Black and orange outer shells included

Typical properties

Attenuation Rating: 20 dB

Audio Type: Communication

Auxiliary Port: J22

Battery Life: Approx. 600 hours

Brands: PELTOR™

CSA Class: White

Communication Direction: Listen-only

Communication Type: Environmental Listening

Connection Type: Wireless

He

3M™ PELTOR™ Tactical Sport™ MT16H210F-SV, Electronic Headset, Foldable Headband, Black, 10 Each/Case

Part Number 93407 3M Product Number MT16H210F-SV 3M ID 7010301924

Details

A premier hearing protection and communication solution for high noise environments

Great for hunters and shooters

Environmental microphones allow face-to-face conversation and improved situational awareness in quiet and low-to-moderate levels of noise

Foam and liquid-filled cushions provide lasting comfort and an effective acoustic seal for long duration wear times

Foldable, adjustable headband provides a comfortable and secure fit, and folds over the earcups for compact storage

Typical properties

Attenuation Rating: 20 dB

Audio Type: Communication

Auxiliary Port: J22

Battery Life: Approx. 600 hours

Brands: PELTOR™

CSA Class: White

Communication Direction: Listen-only

Communication Type: Environmental Listening

Hearing Protection Style: Ear

3M™ PELTOR™ ProTac Hunter (Slim) Headset, Green, Headband

3M Product Number MT13H222A 3M ID 7100088458 UPC 04054596123137

Details

Professional-Quality Hearing Protection (21dB NRR)

Environmental microphones for level-dependent hearing protection and ambient listening

3.5 mm listen-only stereo input for connection to external devices (e.g. cell phone, two-way radio, Ipad)

Voice guided menu system for ease of use and adjusting settings

Auto power off, the headset will turn off after 4 hrs of non-use to save battery

Low-battery warning to inform you when to change batteries

To reduce corrosion caused by sweat and moisture, the electronics are located in a separate compartment of the cup

Typical properties

Attenuation Rating: 21 dB

Audio Type: Communication

Auxiliary Port: 3.5mm

Battery Life: 100 Hours

Bluetooth: No

Brands: PELTOR™

Built In FM and or AM Radio: No

Built in 2-Way Radio: No

Case Quantity: 10

Communication Direction: Listen-only
Commu

3M™ E-A-Rsoft™ SuperFit™ Earplugs

Details

Tapered shape and smooth texture to help with comfort
Orange color band serves as a training tool to help see how deeply the earplug is inserted

Compatible with the 3M™ E-A-Rfit™ Validation System

Available with and without cords to suit user preference

Dispenser packaging option available for uncorded earplugs

CSA Class AL

*U.S. EPA specifies the NRR as the measure of hearing protector noise reduction. However, 3M makes no warranties as to the suitability of the NRR for this purpose. 3M strongly recommends personal fit testing of hearing protectors. Research suggests that users may receive less noise reduction than indicated by the attenuation label value(s) on the packaging due to variation in fit, fitting skill, and motivation of the user. Refer to applicable regulations or guidance on how to adjust attenuation label values. It is recommended that the NRR be reduced by 50% to better estimate typical protection

Typical properties

Attenuation Rating: 33.0 Decibel

Banded: No

Case Quantity: 2000 Pair

Cord Color: Orange

Cord Type: None, Vinyl

Corded: No, Yes

Dielectric: No

Dispenser Available: No, Yes

Earplug Material: Foam

Earplug Shape: Bullet

Earplug Size: Regular

Electr

3M™ PELTOR™ Patch Cable, FL6BR-01, 1 EA/CS

Part Number FL6BR-01 3M Product Number FL6BR-01 3M ID 7100221037

Details

Patch cable for connecting the 3M™ PELTOR™ LiteCom Plus or LiteCom Pro III Headset to a 3M™ PELTOR™ PTT Adapter
Enables communication between a 3M™ PELTOR™ LiteCom Series Headset and an external communication device
Not certified as intrinsically safe

Typical properties

Auxiliary Port: 4-pin XLR
Brands: PELTOR™
Case Quantity: 1 EA/CS
Intrinsically Safe: No
Plug Type: J11
Product Color: Black
Product Type: Cable
eClass 14 Classification Group: 40270191

3M™ DBI-SALA® Floor Mount Sleeve Davit Base

Details

Floor mount sleeve davit base
Bolt-in install to existing concrete or steel floors
Standard and flush mount design with recessed fastener pockets available
High strength steel construction
Durable plated hardware
Provides for 360 degree davit mast rotation (if applicable)
Permanent installation with standard tools
PVC davit mast sleeve liner
Available in zinc plated steel or stainless steel

Typical properties

Case Quantity: 1
Connected Safety ID Equipped: No
Dimensions:
10.20x10.20x23.60cm, 10.00x10.00x9.30lbs, 30.40x20.30x23.60cm, 25.40x25.40x
23.60cm
Install Type: Portable
Material: Galvanized Steel, Stainless Steel
Net Weight (Imperial): 14.5 lb, 16.8 lb,

3M™ DBI-SALA® Flexiguard™ Trailer Mounted Adjustable Height Anchor

System 8530690, 2 User, Yellow, 12.75 – 20.5 ft

Part Number 8530690 3M Product Number 8530690 3M ID 7100231988

Details

Utilizes integrated counterweight to provide a stand alone solution
Two shock-absorbing arms overhead anchroages provide secure anchoring for up to two users
Anchor is height-adjustable from 10 ft.–21.5 ft. (3.0 m–6.6 m) with a 4.5 ft. (1.4 m) offset
Rated for off-road use only
One part of your personal fall protection system; intended for use with personal protective equipment including (but not limited to) harnesses and self-retracting lifelines
Conforms to the requirements of OSHA 1926.502 and OSHA 1910.140
Suitable for numerous applications within the transportation, construction, utilities, and mining industries
Steel Leveling Jacks capacity of 7,000 lb. (3,175 kg)

Typical properties

Brands: DBI-SALA®
Case Quantity: 1
Connected Safety ID Equipped: No
Install Type: Temporary/Portable
Maximum Number of Users: Two
Net Weight (Imperial): 4570 lb
Net Weight (Metric): 2072.9 kg
Product Color: Silver
Product Series: FlexiGuard™
Prod

Dimensions and Classifications

Overall Height (Imperial): 252.5 in
Overall Height (Metric): 641.35 cm

3M™ Tool Pouch with D-ring and Retractors 1500128, Canvas, Black, 8.75 in x 13 in

3M Product Number 1500128 3M ID 7100314288

Details

Compatible with 3M™ DBI-SALA® and Protecta® Fall Protection systems and components

Enable workers to secure tools and accessories while working at height

Multiple materials, closure systems, and attachment point options designed for a variety of applications

Typical properties

Brands: DBI-SALA®

Case Quantity: 1

Connected Safety ID Equipped: No

Dimensions: 8.50 x 5.00 x 13.00 inch

Manufacturing Origin: Taiwan

Net Weight (Metric): 0.51 kg

Product Color: Black

Product Type: Tool Pouch Extra Deep with D-Ring and Retractors (

Dimensions and Classifications

Overall Height (Metric): 59.69 mm

Overall Length (Metric): 356.87 mm

3M™ Tool Pouch with D-ring 1500124, Canvas, Black, 7.5 in x 11 in

3M Product Number 1500124 3M ID 7100238136 UPC 00852684932388

Details

Compatible with 3M™ DBI-SALA® and Protecta® Fall Protection systems and components

Enable workers to secure tools and accessories while working at height

Multiple materials, closure systems, and attachment point options designed for a variety of applications

Typical properties

Brands: 3M™

Case Quantity: 1

Connected Safety ID Equipped: No

Dimensions: 7.00 x 5.00 x 10.00 inch

Manufacturing Origin: Taiwan

Net Weight (Metric): 0.86 kg

Product Color: Black

Product Type: Tool Pouch with D-Ring

Recommended Industry: Constructi

Dimensions and Classifications

Overall Height (Metric): 67.31 mm

Overall Length (Metric): 285.75 mm

3M™ Tool Pouch with D-ring and Triggers 1500126, Canvas, Black, 7.5 in x 11 in

3M Product Number 1500126 3M ID 7100311719 UPC 00852684932456

Details

Compatible with 3M™ DBI-SALA® and Protecta® Fall Protection systems and components

Enable workers to secure tools and accessories while working at height

Multiple materials, closure systems, and attachment point options designed for a variety of applications

Typical properties

Brands: DBI-SALA®

Case Quantity: 1

Connected Safety ID Equipped: No

Dimensions: 7.00 x 5.00 x 10.00 inch

Product Color: Black

Product Type: Tool Pouch with D-Ring and Triggers (2)

Recommended Industry: Construction, General Industrial, Mining, Oil &

3M™ Utility Tool Pouch 1500132, Canvas, White

3M Product Number 1500132 3M ID 7100270183 UPC 00852684932548

Details

Compatible with 3M™ DBI-SALA® and Protecta® Fall Protection systems and components

Enable workers to secure tools and accessories while working at height

Multiple materials, closure systems, and attachment point options designed for a variety of applications

Typical properties

Brands: DBI-SALA®

Case Quantity: 1

Connected Safety ID Equipped: No

Dimensions: 9.75 x 5.00 x 10.12 inch

Manufacturing Origin: Taiwan

Net Weight (Metric): 0.47 kg

Product Color: White

Product Type: Utility Pouch

Recommended Industry: Construction,

Dimensions and Classifications

Overall Height (Metric): 77.47 mm

Overall Length (Metric): 317.5 mm

3M™ DBI-SALA® Cell Phone Holder Pouch For Harness 9501264, Hook and Loop

3M Product Number 9501264 3M ID 7012821177 UPC 00840779002801

Details

Compatible with 3M™ DBI-SALA® and Protecta® Fall Protection systems and components

Enable workers to secure tools and accessories while working at height

Multiple materials, closure systems, and attachment point options designed for a variety of applications

Typical properties

Brands: DBI-SALA®

Case Quantity: 1

Connected Safety ID Equipped: No

Dimensions: 76.00x150.00x25.00mm

Net Weight (Imperial): 0.1 lb

Net Weight (Metric): 0.04 kg

Product Color: Blue

Product Type: Cell Phone Holder Pouch

Recommended Industry: Constru

3M™ DBI-SALA® Inspection Pouch 1500131, 1 EA

3M Product Number 1500131 3M ID 7100210236 UPC 00852684932210

Details

Compatible with 3M™ DBI-SALA® and Protecta® Fall Protection systems and components

Enable workers to secure tools and accessories while working at height

Multiple materials, closure systems, and attachment point options designed for a variety of applications

Typical properties

Brands: DBI-SALA®

Case Quantity: 1

Connected Safety ID Equipped: No

Dimensions: 9.62 x 5.62 x 3.00 inch

Manufacturing Origin: Taiwan

Net Weight (Metric): 0.43 kg

Product Color: Black

Product Type: Inspection Pouch

Recommended Industry: Constructio

Dimensions and Classifications

Overall Height (Metric): 73.66 mm

Overall Length (Metric): 293.37 mm

3M™ Spill Control Long Safe Bucket with Hook and Loop Closure 1500136, 100 lb Capacity, Canvas, 48 in

3M Product Number 1500136 3M ID 7100237395 UPC 00852684934740

Details

Compatible with 3M™ DBI-SALA® and Protecta® Fall Protection systems and components

Enable workers to secure tools and accessories while working at height

Multiple materials, closure systems, and attachment point options designed for a variety of applications

Typical properties

Brands: DBI-SALA®

Case Quantity: 1

Connected Safety ID Equipped: No

Manufacturing Origin: China

Net Weight (Metric): 2.13 kg

Product Color: Black, Yellow

Product Type: Long Safe Bucket 100 lb Load Rated Hook & Loop Canvas

Recommended Industry: Cons

Dimensions and Classifications

Overall Height (Metric): 1946.28 mm

Overall Length (Imperial): 4 ft

Overall Length (Metric): 219.08 mm

3M™ Spill Control Safe Bucket with Drawstring Closure 1500139, 250 lb Capacity, Vinyl, 12.5 in dia x 15 in

3M Product Number 1500139 3M ID 7100279876 UPC 00840779112319

Details

Compatible with 3M™ DBI-SALA® and Protecta® Fall Protection systems and components

Enable workers to secure tools and accessories while working at height

Multiple materials, closure systems, and attachment point options designed for a variety of applications

Typical properties

Brands: DBI-SALA®

Case Quantity: 1

Connected Safety ID Equipped: No

Manufacturing Origin: China

Net Weight (Metric): 1.63 kg

Product Color: Black, Yellow

Product Type: Safe Bucket Drawstring Vinyl

Recommended Industry: Construction, General Industr

Dimensions and Classifications

Overall Height (Metric): 182.88 mm

Overall Length (Metric): 405.13 mm

3M™ Spill Control Safe Bucket with Hook and Loop Closure 1500140, 250 lb Capacity, Vinyl, 12.5 in dia x 15 in

3M Product Number 1500140 3M ID 7100241957 UPC 00840779112326

Details

Compatible with 3M™ DBI-SALA® and Protecta® Fall Protection systems and components

Enable workers to secure tools and accessories while working at height

Multiple materials, closure systems, and attachment point options designed for a variety of applications

Typical properties

Brands: 3M™

Case Quantity: 1

Connected Safety ID Equipped: No

Manufacturing Origin: China

Net Weight (Metric): 1.86 kg

Product Color: Black, Yellow

Product Type: Safe Bucket Hook and Loop Vinyl

Recommended Industry: Construction, General Industrial

Dimensions and Classifications

Overall Height (Metric): 144.78 mm

Overall Length (Metric): 533.4 mm

3M™ Protecta® Compact Equipment Storage Pouch AK048A, 12 in x 0.5 in x 12.5 in

3M Product Number AK048A 3M ID 7012822282

Details

Compatible with 3M™ DBI-SALA® and Protecta® Fall Protection systems and components

Enable workers to secure tools and accessories while working at height

Multiple materials, closure systems, and attachment point options designed for a variety of applications

Typical properties

Brands: PROTECTA®

Case Quantity: 1

Connected Safety ID Equipped: No

Dimensions: 12.00x0.50x12.50in

Net Weight (Imperial): 0.3 lb

Net Weight (Metric): 0.1 kg

Product Color: Red

Product Type: Compact Equipment Storage Pouch

Recommended Industry: Con

3M™ DBI-SALA® Confined Space Tripod System

Details

- Systems available to adapt to multiple configurations
- Telescoping adjustable locking legs
- Built-in pulley system
- Rubber padded tripod feet and leg support chain
- Integrated 5,000 lb. (22 kN) eyebolt anchor points
- Features manually operated winch
- Winch options available with different gear ratios to provide mechanical advantage
- Swiveling snap hook with built-in impact indicator
- Equipped with pre-programmed RFID

Typical properties

- Brands: DBI-SALA®
- Carabiner/Hook Material: Zinc Plated Steel
- Connected Safety ID Equipped: Yes
- Install Type: Portable
- Lifeline Length (Imperial): 50 ft, 60 ft, 90 ft
- Lifeline Length (Metric): 15.2 m, 18.3 m, 27.4 m
- Lifeline Material: Galvanized Cabl

Dimensions and Classifications

- Overall Height (Imperial): 7 ft, 9 ft
- Overall Height (Metric): 2.13 m, 2.7 m

3M™ Scotchlite™ Reflective Material 8925 Series

Details

3M™ Scotchlite™ Reflective Material is designed for enhancing visibility in low light and nighttime conditions
Certified to various global high visibility standards such as ANSI/ISEA 107
Sew-on application

Typical properties

Adhesive: None
Attachment Type: Sew On
Backing: None
Backing Material: Polyester/Cotton
Brands: Scotchlite™
Certified Performance Required: ANSI 107-2015, CSA Z95-2015, Oeko-Tex
Daytime Color: Silver
Dry-Cleaning Cycles at ANSI Certified Standards:

Dimensions and Classifications

Overall Length (Imperial): 54.68 yd, 109.36 yd, 218.72 yd
Overall Length (Metric): 50 m, 100 m, 200 m
Overall Width (Imperial): 0.63 in, 0.9 in, 1 in, 1.5 in, 2 in, 2.36 in, 2.75 in, 36 in, 42 in, 50 in
Overall Width (Metric): 15.88 mm, 22.23 mm, 25.4

3M™ Scotchlite™ Reflective Material 8986 Series

Details

3M™ Scotchlite™ Reflective Material is designed for enhancing visibility in low light and nighttime conditions
Certified to various flame resistant standards such as NFPA
Fluorescent properties help to make material highly visible in daylight, dawn and dusk
Sew-on application

Typical properties

Adhesive: None
Attachment Type: Sew On
Backing: None
Brands: Scotchlite™
Certified Performance Required: None
Daytime Color: Fluorescent Red-Orange
Flame Resistant: Yes
Initial Average RA: 175
Product Series: 8986
Recommended Industry: First Resp

Dimensions and Classifications

Overall Length (Imperial): 54.68 yd, 109.36 yd
Overall Length (Metric): 50 m, 100 m
Overall Width (Imperial): 1 in, 2 in, 36 in
Overall Width (Metric): 25.4 mm, 50.8 mm, 914.4 mm

3M™ PELTOR™ Charging Cable, AL2AH, 1 EA/Case

3M Product Number AL2AH 3M ID 7100067410 UPC 07318640063051

Details

Charging cable for intrinsically safe rechargeable battery packs
1 each/case

Typical properties

Brands: PELTOR™
Compatible Radio Brands: Alan
Intrinsically Safe: No
Product Color: Black
Product Type: Cable
Recommended Industry: Agriculture
eClass 14 Classification Group: 40270191

3M™ PELTOR™ Charging Cable FR09 for Lite-Com BRS Headset Battery ACK053, 1 EA/Case

3M ID 7100075611 UPC 07318640063655

Details

Charging cable for Lite-Com BRS Headset Battery ACK053
1 each/case

Typical properties

Brands: PELTOR™
Case Quantity: 1
Product Type: Cable
eClass 14 Classification Group: 40270191

3M™ DBI-SALA® ExoFit™ Comfort Vest Retrieval Safety Harness 1108750, X-Small

3M ID 7012815670 UPC 00840779030002

Details

Built-in shoulder, back and leg comfort padding (on select models)
Protected labels, equipped with an integrated RFID tag, enabling inventory, inspection, and record management
Required warnings / labels Product warnings and labels are contained in the product label packs (on product) and IFU's per the relevant standards

Typical properties

Body Belt: No
Brands: DBI-SALA®
Buckle Type: Quick Connect
Case Quantity: 1
Chest Buckle Material: Zinc Plated Steel
Connected Safety ID Equipped: Yes
D-ring Placement: Back, Shoulder
Harness Size: X-Small
Leg Buckle Material: Zinc Plated Steel
P

3M™ Versaflo™ Painter`s Supplied Air Respirator Kit SA-100-PSK/37336(AAD), 1 EA/Case

Part Number 37336 3M Product Number SA-100-PSK 3M ID 7000127696

Details

Includes a V-100 Vortex Cooling Assembly, BT-20L Breathing Tube with BT-922 Breathing Tube Cover, and an M-206 Headtop

V-100 Vortex Cooling Assembly helps cool compressed air up to 50 degrees Fahrenheit; The V-100 includes the waist belt, cooling valve, and holder

M-206 Headtop meets the requirements of the ANSI Z87.1-2010 standard for limited eye and face protection

Large visor provides wide peripheral and downward lines of sight

Complete this NIOSH-approved system with a 3M supplied air hose (sold separately)

Typical properties

Air Source: SAR

Brands: Versaflo™

Breathing Tube Type: Back-Mounted

CFM Capacity per Minute: 100 CFM, 50 CFM

Hazard Type: Mold, Silica

Headgear Type: Headgear with clear visor

Mounting Type: Belt-mounted

Pressure Type: High

Product Color: Gray

Pr

3M™ Virtua™ VX6 Safety Glasses

3M ID B00034292

Details

Economy-rated protective glasses blend style, comfort, and affordability

Sporty look complements the appearance of the wearer

Wraparound design provides extended eye protection and unobstructed viewing

Popular for use in industries including aviation, chemicals, construction, food and beverage, general manufacturing, mining, oil and gas, pharmaceuticals, primary metals, construction, and transportation

Polycarbonate lens absorbs 99.9% of harmful UVA and UVB rays

Meets the Impact-Rated Protector requirement of the ANSI-ISEA Z87.1-2020 Standard

Indoor and outdoor use

Typical properties

eClass 14 Classification Group: 40230101

3M™ Brow Guard Eyewear, Black/Green, Gray Lens, 1 Pack

3M ID 70009110324 UPC 00638060279601

Details

Durable Lenses Help Provide Limited Protection From Light To Moderate Impact Hazards
Lightweight, Durable Design For Comfort And Lasting Wear
Brow Guard Helps Keep Sweat And Debris Out Of Your Eyes
Compatible With Many Types Of Additional Personal Protection Equipment (Ppe)
Soft Touch Nose Pads And Earpiece Enhance Comfort
Contoured Wrap Around Design Provides Extended Eye Protection And Unobstructed View
Anti Fog, Scratch Resistant Lens Helps Keep Vision Clear
Impact-resistant lens blocks 99.9% of UV rays
Meets the requirements of ANSI Z87.1, CSA Z94.3 and AS/NZS 1337
Gray Lenses Help Reduce Sunlight And Are Popular For Outdoor Use
Contains: 1 Pair of Safety Glasses

Typical properties

Brands: 3M™
Catalog Number: 47101H1-VDC
Factory ISO Certification: No ISO Certification information available
Material: Polycarbonate
Product Color: Black
eClass 14 Classification Group: 40230101

3M™ SecureFit™ Anti-Fog Eyewear with Scotchgard™ Protector 47213H1-VDC-PS, Blue/Clear, Clear Lens, Anti-Fog, 5/case

3M ID 70009126809 UPC 00638060921388

Details

Patented 3M™ Pressure Diffusion Temple technology helps diffuse pressure over the ear

Adjustable ratchet temples help create a secure and personalized fit

Scotchgard™ Protector resists fogging longer than traditional anti-fog coatings, even after multiple washes with water* (*Based on 3M internal testing per EN168 test method when compared with traditional anti-fog coatings.)

Fits over most glasses to protect prescription eyewear

Impact-resistant lenses absorb 99.9% of UVA and UVB rays

Soft, conformable nose pads

Durable, lightweight material for lasting comfort

Scratch-resistant lenses

Compatible with a variety of Personal Protection Equipment (PPE)

Meets the requirements of ANSI Z87.1 and CSA Z94.3

Typical properties

Brands: 3M™

Catalog Number: 47213H1-VDC-PS

Factory ISO Certification: No ISO Certification information available

eClass 14 Classification Group: 40230101

3M™ Performance Eyewear 47070H1-DC Black/Gray, Clear Lens, Anti-Fog, 4/Case

3M ID 70006983061 UPC 00051125003995

Details

Anti-fog, scratch-resistant lenses help keep vision clear
Soft-touch nose and earpieces enhance comfort
Lightweight, durable design for comfort and lasting wear
Durable lenses help provide limited protection from light to moderate impact
Impact-resistant lens blocks 99.9% of UV rays
Meets the requirements of ANSI Z87.1 , CSA Z94.3 and AS/NZS 1337
Clear lenses help provide excellent visibility and can be used indoors or outdoors
Includes a handy storage bag and lanyard to help prevent damage and loss

Typical properties

Brands: 3M™
Catalog Number: 47070H1-DC
Factory ISO Certification: No ISO Certification information available
Frame Material: Polycarbonate
Frame Style: Wraparound
Material: Polycarbonate
Sealed Eyewear: No
Splash Protection: No
Standards and Speci

Dimensions and Classifications

Overall Height (Imperial): 7.75 in
Overall Height (Metric): 196.85 mm
Overall Length (Imperial): 3.11 in
Overall Length (Metric): 78.99 mm
Overall Width (Imperial): 5.75 in
Overall Width (Metric): 146.05 mm

3M™ Performance Eyewear Anti-Fog, 47070H1-DC, Black/Gray, Clear Lens, 4/Case

3M ID 70006983079 UPC 00051125004015

Details

Anti-fog, scratch-resistant lenses help keep vision clear
Soft-touch nose and earpieces enhance comfort
Lightweight, durable design for comfort and lasting wear
Durable lenses help provide limited protection from light to moderate impact
Impact-resistant lens blocks 99.9% of UV rays
Meets the requirements of ANSI Z87.1 , CSA Z94.3 and AS/NZS 1337
Gray lenses help reduce sunlight and are popular for outdoor use
Includes a handy storage bag and lanyard to help prevent damage and loss

Typical properties

Brands: 3M™
Catalog Number: 47071H1-DC
Factory ISO Certification: No ISO Certification information available
Frame Material: Polycarbonate
Frame Style: Wraparound
Material: Polycarbonate
Sealed Eyewear: No
Splash Protection: No
Standards and Speci

Dimensions and Classifications

Overall Height (Imperial): 7.75 in
Overall Height (Metric): 196.85 mm
Overall Length (Imperial): 3.11 in
Overall Length (Metric): 78.99 mm
Overall Width (Imperial): 5.75 in
Overall Width (Metric): 146.05 mm

3M™ Performance Eyewear Anti-Fog, 47071H1-DC, Black/Gray, Gray Lens, 4/Case

3M ID 70006983087 UPC 00051125004022

Details

Anti-fog, scratch-resistant lenses help keep vision clear
Soft-touch nose and earpieces enhance comfort
Lightweight, durable design for comfort and lasting wear
Durable lenses help provide limited protection from light to moderate impact
Impact-resistant lens blocks 99.9% of UV rays
Meets the requirements of ANSI Z87.1 , CSA Z94.3 and AS/NZS 1337
Amber lenses enhance contrast in low light conditions
Includes a handy storage bag and lanyard to help prevent damage and loss

Typical properties

Brands: 3M™
Catalog Number: 47072H1-DC
Factory ISO Certification: No ISO Certification information available
Frame Material: Polycarbonate
Frame Style: Wraparound
Material: Polycarbonate
Sealed Eyewear: No
Splash Protection: No
Standards and Speci

Dimensions and Classifications

Overall Height (Imperial): 7.75 in
Overall Height (Metric): 196.85 mm
Overall Length (Imperial): 3.11 in
Overall Length (Metric): 78.99 mm
Overall Width (Imperial): 5.75 in
Overall Width (Metric): 146.05 mm

3M™ Performance Eyewear Wrap-Around Protection, Black/Red, Clear Lens

3M ID 70006983095 UPC 00076308725860

Details

- Lightweight for long-lasting comfort
- Vented temple design
- Soft-touch nose and ear pieces for a comfortable, secure fit
- Large, full-coverage lens provides extra protection
- Built-in brow guard helps keep sweat and debris away from eyes
- Ultra-sport design with athletic look and feel
- Lenses absorb 99.9% UV
- Meets the requirements of ANSI Z87.1-2010
- Contains 1 safety eyewear/pack

Typical properties

- Anti Fog Lens: Yes
- Brands: 3M™
- Catalog Number: 47090H1-DC
- Comfort Features: Brow and nose bridge, Elastomeric browguard
- Factory ISO Certification: No ISO Certification information available
- Frame Material: Polycarbonate
- Frame Style: Wraparound
- Hard

Dimensions and Classifications

- Overall Height (Imperial): 5.75 in
- Overall Height (Metric): 146.05 mm
- Overall Length (Imperial): 7 in
- Overall Length (Metric): 177.8 mm
- Overall Width (Imperial): 7.75 in
- Overall Width (Metric): 196.85 mm

3M™ Performance Eyewear Wrap-Around Protection, Black/Red, Gray Lens

3M ID 70006983103 UPC 00076308725907

Details

Durable lenses help provide limited protection from light to moderate impact hazards

Lightweight, durable design for comfort and lasting wear

Brow guard helps keep sweat and debris out of your eyes

Soft-touch nose pads and earpiece enhance comfort

Contoured wrap-around design provides extended eye protection and unobstructed view

Anti-fog, scratch-resistant lens helps keep vision clear

Impact-resistant lens blocks 99.9% of UV rays

Meets the requirements of ANSI Z87.1 , CSA Z94.3 and AS/NZS 1337

Gray lenses help reduce sunlight and are popular for outdoor use

Typical properties

Anti Fog Lens: Yes

Brands: 3M™

Catalog Number: 47091H1-DC

Comfort Features: Brow and nose bridge, Elastomeric browguard

Factory ISO Certification: No ISO Certification information available

Frame Material: Polycarbonate

Frame Style: Wraparound

Hard

Dimensions and Classifications

Overall Height (Imperial): 5.75 in

Overall Height (Metric): 146.05 mm

Overall Length (Imperial): 7 in

Overall Length (Metric): 177.8 mm

Overall Width (Imperial): 7.75 in

Overall Width (Metric): 196.85 mm

3M™ Foam Gasket Safety Eyewear, Mirror Lens, Anti-Fog

3M ID 70006991031 UPC 00638060187654

Details

Durable lenses help provide limited protection from light to moderate impact hazards
Lightweight, durable design for comfort and lasting use
Contoured temples fit comfortably and snugly
Removable foam gasket helps limit eye exposure to certain dust and debris while providing added comfort and cushioning
Gasket removes easily for cleaning of safety glasses or if gasket is not needed
Wraparound lens design provides extended eye protection and view
Scratch-resistant lenses help keep vision clear
Impact-resistant lenses block 99.9% of UV rays
Meets the requirements of ANSI Z87.1 and CSA Z94.3
Indoor/outdoor mirrored lenses help reduce glare and are popular for inside and outside environments
Lens Color: Mirror

Typical properties

Brands: 3M™
Catalog Number: 47200-HZ6-NA
Factory ISO Certification: No ISO Certification information available
eClass 14 Classification Group: 40230101

3M™ DBI-SALA® RollGliss™ RPD 4:1 Ratio Rescue Positioning Device Kit 3602250, 3/8 in Nylon Kernmantle Rope, 250 ft

Part Number 3602250 3M Product Number 3602250 3M ID 7012819487

Details

Designed for raising, lowering, and positioning
Manual control for ascent and descent
Pre-rigged system with speed-sensing braking mechanism
High strength corrosion resistant construction

Typical properties

Brands: DBI-SALA®
Case Quantity: 1
CoWorker Controlled Ascent: Yes
CoWorker Controlled Descent: Yes
Connected Safety ID Equipped: Yes
Descent Type: Vertical
Dimensions: 4.50x1.50x10.00in
Lifeline Material: Kernmantle, Braided Polyester Cover with N

Dimensions and Classifications

Overall Length (Imperial): 250 ft

3M™ DBI-SALA® SecuraSpan™ Pour-in-Place Horizontal Lifeline System

3M ID B00036510

Details

Portable design is durable, yet lightweight, for easy transport

Rugged, galvanized cable lifeline for exceptional durability

Stanchions have removable screw-in handles for easy set-up

Built-in, turnbuckle tensioner helps your worker tension the system to the safe level

Metal energy absorbers help protect the structure, and minimize needed fall clearance

This safety equipment is intended for use with additional personal protective equipment (PPE)

Recommended for use in multiple industries including construction, facilities, general manufacturing, heavy infrastructure, and more

Intended for use as horizontal lifeline system

Suitable for single and multi-span lifeline configurations

3M™ DBI-SALA® SecuraSpan™ Loop Rebar Horizontal Lifeline System 7400360, 1 EA

3M ID 7100188827 UPC 00840779004904

Details

Zinc-plated steel materials stand up to harsh environments
Rugged, galvanized cable lifeline for reliable fall protection
Metal energy absorbers limit help protect the structure, and minimize needed fall clearance
Intended for use as a temporary horizontal lifeline system
Equipped with Connected Safety RFID identification tag for convenient equipment tracking
This safety equipment is designed for use with additional personal protective equipment (PPE)
Single-span systems hold up to 2 workers; multi-span systems hold up to 6 workers
Portable design is durable, yet lightweight, for easy transport
Recommended for use in multiple industries including construction, facilities, power plants, general manufacturing, heavy infrastructure, and more

Typical properties

Brands: DBI-SALA®
Case Quantity: 1
Connected Safety ID Equipped: Yes
Install Type: Temporary/Portable
Lifeline Material: Galvanized Cable
Maximum Number of Workers: 2 Per Span, 6 Total
Product Series: SecuraSpan™
Product Type: Concrete
Recommended

Dimensions and Classifications

Overall Length (Imperial): 60 ft

3M™ Versaflo™ Replacement Visor Frame Buttons M-919, 10 EA/Case

3M Product Number M-919 3M ID 7000127686 UPC 00051131173309

Details

Replacement parts for all 3M™ Versaflo™ M-Series products

Typical properties

Brands: Versaflo™

Case Quantity: 10

Compatible With: 3M™ Versaflo™ M-Series Helmet

Headgear Type: Headcover

High Heat: No

Product Series: M-Series

Product Type: Faceshield

3M™ E-A-Rfit™ Dual-Ear Microphone Assembly 073-781

3M Product Number 073-781 3M ID 7100077867 UPC 00078371670146

Details

Dual-element, dual-microphone assembly for use with 3M™ E-A-Rfit™ Dual-Ear Validation System

Dual-ear design saves time by testing both ears simultaneously in under five seconds

Inserts into the back of the 3M™ E-A-Rfit™ Dual-Ear Enclosure Speaker Assembly

Each dual-element microphone connects to probed test plugs, test pods, or cushions and measures sound pressure levels outside and inside the hearing protector

Y-connector between right & left microphone denotes distance user should sit from speaker

Typical properties

Brands: 3M™

Case Quantity: 1

Product Type: Microphone

Recommended Application: Health & Safety Testing

Recommended Industry: Automotive, General Manufacturing, Metal Fabrication, Military Maintenance, Repair & Operation (MRO), Mining, Oil & Gas, Pharm

3M™ PELTOR™ Welding Hygiene Kit HY505, for Welding Earmuffs, 10 EA/Case

3M Product Number HY505 3M ID 7000103822 UPC 04046719543496

Details

Hygiene kit for H505B Earmuff

10 ea per case

3M PSD products are for occupational use only

*The NRR may overestimate the hearing protection provided during typical use

Typical properties

Brands: PELTOR™

Case Quantity: 10

Compatible Earmuff: Welding HY505

Hygiene Kit: Yes

Product Color: Black

Product Series: HY505

Product Type: Hygiene Kit

Recommended Application: Grinding, Welding

Recommended Industry: Automotive, General Manufact

3M™ VFlex™ Particulate Respirators 9100 Series

Details

V-shaped pleats expand for ease of breathing and flex with mouth movement while talking
Uniquely designed tabs allow for improved positioning on the face
Available in two sizes to fit a broad range of faces
Flat-fold design for convenient storage prior to use
Spacious inside with minimal impact on field of vision
Embossed front panel helps respirator retain its shape
Proprietary 3M™ Advanced Electrostatic Filter Media filters dust and other particles while allowing for easy breathing
Adjustable noseclip helps provide a custom and secure seal
Compatible with a variety of eyewear and hearing protection
NIOSH approved for at least 95 percent filtration efficiency against certain non-oil based particulates
Patented. See 3M.com/patent

Typical properties

Acid Gas Reduction: No
Advanced Electrostatic Media: Yes
Braided Comfort Strap: Yes
Cake-Resistant Filter Media: No
Class: Comfort
Cool Flow™ Exhalation Valve: No
Enhanced Comfort: No
Environment - Hot or Humid: No
Exhalation Valve: No
Faceseal:

3M™ Health Care Particulate Respirator & Surgical Mask 1860 Series

Details

NIOSH N95 approved for at least 95 percent filtration efficiency against certain non-oil based particulates
FDA cleared for use as a surgical mask. Fluid resistant (according to ASTM F1862) to splash and spatter of blood and other infectious materials
Meets CDC guidelines for Mycobacterium Tuberculosis exposure control
The soft inner material, nose-foam, and braided headbands help provide comfort
The adjustable noseclip helps provide a custom and secure seal
3M proprietary filter media designed for ease of breathing
Intended to help reduce wearer exposure to certain airborne particles including those generated by electrocautery, laser surgery, and other powered medical instruments
Contains no components made from natural rubber latex
> 99% BFE (Bacterial Filtration Efficiency) according to ASTM F2101

Typical properties

Advanced Electrostatic Media: Yes
BFE: > 99%
Braided Comfort Strap: Yes
Class: Market Leader
Exhalation Valve: No
Faceseal: No
Features: Advanced Electrostatic Media
Filter Class: N95
Flame Resistance (ASTM D2859-96): No
Fluid Resistant (ASTM F18

3M™ V-Series Supplied Air Regulator Valves & Assemblies

Details

Low maintenance - no filters, cartridges, or batteries to maintain
Certain 3M supplied air valves can cool or heat air by up to 50°F (28°C)
Can operate on pressures ranging from 6-91 psig, depending on valve and hose length
All V-Series Supplied Air Valves require an approved 3M supplied air hose, breathing tub and headgear to complete the NIOSH-approved respirator system

Typical properties

Brands: Versaflo™
CFM Capacity per Minute: 100 CFM, 50 CFM
Cartridge or Filter Included: No
Case Quantity: 1
Compatible With: 3M™ Adflo™ PAPR, 3M™ L-Series Headgear, 3M™ V-300 Valve Assembly, 3M™ Valve Assembly V-100, 3M™ Versaflo™ Air Regulating Valv

3M™ Decon Belt RBE-BLT, 1 EA/Case

3M Product Number RBE-BLT 3M ID 7000126825 UPC 00051131918887

Details

This belt is used in the 3M™ Powered Air Purifying Respirator (PAPR) Systems RBE-NM10, RBE-L10, RBE-NMB and RBE-LB
Fits waist sizes up to 60 inches

Typical properties

Brands: 3M™

Case Quantity: 1/case

Compatible With: 3M™ Breathe Easy™ PAPR

Product Series: Breathe Easy

Product Type: Belt

3M™ Waist Belt GVP-117, Vinyl, 1 EA/Case

3M Product Number GVP-117 3M ID 7000126101 UPC 00051138292232

Details

For use with 3M™ GVP-Series Belt-Mounted Powered Air Purifying Respirators

Typical properties

Brands: 3M™
Case Quantity: 1/pack
Compatible With: 3M™ GVP-Series PAPR
Material: Vinyl
Mounting Type: Belt-mounted
Product Color: Black
Product Series: GVP
Product Type: Belt
Recommended Industry: Marine

3M™ Waist Belt GVP-127/07152(AAD), Web, 1 EA/Case

3M Product Number GVP-127 3M ID 7000126154 UPC 50051138293661

Details

For use with 3M™ GVP-Series Belt-Mounted Powered Air Purifying Respirators

Typical properties

Brands: 3M™
Case Quantity: 1/pack
Compatible With: 3M™ GVP-Series PAPR
Material: Web
Mounting Type: Belt-mounted
Product Color: Black
Product Series: GVP
Product Type: Belt
Recommended Industry: Marine

3M™ Adflo™ Leather Belt 15-0099-16, 1 EA/Case

3M Product Number 15-0099-16 3M ID 7000126728 UPC 00051131925946

Details

Leather Front
Ventilation Holes
Evenly distributes weight
Replacement Part

Typical properties

Brands: Adflo™
Case Quantity: 1
Compatible With: 3M™ Adflo™ PAPR
Features: Respiratory Accessory
Product Series: Adflo
Product Type: Belt
Purpose: Exclude
Recommended Application: Assembly, Facility Maintenance, Grinding, Machine Operation, Sanding

3M™ Easy Clean Belt TR-327, for Versaflo™ TR-300 PAPR, 1 ea/Case

3M Product Number TR-327 3M ID 7100232714 UPC 00638060430873

Details

Easy to clean
Vinyl

Typical properties

Brands: Versaflo™

Case Quantity: 1/case

Compatible With: 3M™ Versaflo™ TR-300 Series PAPR, 3M™ Versaflo™ TR-300N+ Series PAPR

Hazard Type: Silica

Mounting Type: Belt-mounted

Product Color: Black

Product Series: TR-300, TR-300+, TR-Series

Product Ty

3M™ Versaflo™ Belt Extender TR-626X, for TR-626 High Durability Belt, 1 EA/Case

Part Number 37344 3M Product Number TR-626X 3M ID 7100035832

Details

Comfortable due to ergonomic design
Easy to use
Extendable

Typical properties

Brands: Versaflo™
Case Quantity: 1/case
Compatible With: 3M™ Versaflo™ TR-600 Series Belt, 3M™ Versaflo™ TR-800 Series Belt
Hazard Type: Silica
Product Color: Gray
Product Series: TR-600, TR-800
Product Type: Belt
Recommended Industry: Aggregates,

3M™ High Durability Belt TR-326, for Versaflo™ TR-300 & Speedglas™ TR-300-SG PAPR, 1 EA/Case

3M Product Number TR-326 3M ID 7000127708 UPC 00051131173606

Details

Durable, leather belt
For use with the 3M™ Versaflo™ TR-300 PAPR

Typical properties

Brands: Versaflo™
Case Quantity: 1/case
Compatible With: 3M™ Versaflo™ TR-300 Series PAPR
Hazard Type: Silica
Mounting Type: Belt-mounted
Product Color: Black
Product Series: TR-300, TR-300+
Product Type: Belt
Recommended Application: Cutting, Dri

3M™ Versaflo™ Waist Belt W-2963/07045(AAD), Cotton 1 EA/Case

3M Product Number W-2963 3M ID 7000130736 UPC 00051131070455

Details

Used with the 3M™ W-Series and V-Series Air Control Valves

Typical properties

Brands: Versaflo™

CFM Capacity per Minute: 50 CFM

Case Quantity: 1/pack

Compatible With: 3M™ V-100 Individual Flow Regulator, 3M™ V-200 Individual Flow Regulator, W-Series Air Control Valves

Product Color: White

Product Series: V-Series, Whitecap

Pr

3M™ Comfort Belt CB-1000/37054(AAD) 1 EA/Case

Part Number 37054 3M Product Number CB-1000 3M ID 7000126406

Details

For use with 3M™ GVP-Series Belt-Mounted Powered Air Purifying Respirators

Typical properties

Brands: 3M™

Case Quantity: 1/pack

Compatible With: 3M™ GVP-Series PAPR

Material: Leather

Mounting Type: Belt-mounted

Product Color: Black

Product Series: GVP

Product Type: Belt

3M™ Adflo™ Powered Air Purifying Respirator Belt 35-0099-14, with Quick Connection, 1 EA/Case

3M Product Number 35-0099-14 3M ID 7100025876 UPC 00051141560830

Details

Adflo Belt
Replacement Part

Typical properties

Brands: Adflo™
Case Quantity: 1
Compatible With: 3M™ Adflo™ PAPR
Features: Respiratory Spare Part
Product Series: Adflo
Product Type: Belt
Recommended Application: Assembly, Facility Maintenance, Grinding, Machine Operation, Sanding, Welding
Recomm

3M™ Standard Belt TR-325, for Versaflo™ TR-300 PAPR, 1 EA/Case

3M Product Number TR-325 3M ID 7000127707 UPC 00051131173590

Details

Economical and easy to use
Approximately 64 inches
Polyester

Typical properties

Brands: Versaflo™
Case Quantity: 1/case
Compatible With: 3M™ Versaflo™ TR-300 Series PAPR
Hazard Type: Silica
Mounting Type: Belt-mounted
Product Color: Black
Product Series: TR-300, TR-300+
Product Type: Belt
Recommended Application: Cleaning, Cu

3M™ Welding Prefilters

Details

Particulate prefilter

Replacement Part

For highest possible safety and comfort, regularly check your equipment for worn or damaged parts

Typical properties

Brands: Adflo™

Case Quantity: 12,6,50

Compatible Respirator: 3M Adflo Powered Air Purifying Respirator

Compatible with 3M™ PAPR Systems: Yes

Compatible with 3M™ Supplied Air System: No

Material: Polyester

Part Type: Consumable

Product Series: Adflo

3M™ Portable Compressed Air Filter and Regulator Panel 256-02-01, 100 cfm, 8 outlets, with Carbon Monoxide Monitor 1 EA/Case

Part Number 72122 3M Product Number -600426 3M ID 7000052147

Details

This panel is an eight outlet air purification system that monitors carbon monoxide (CO)
It is packaged in a protective carrying case for total portability

Typical properties

Battery Type: Alkaline 9V
Brands: 3M™
CFM Capacity per Minute: 100 CFM
Case Quantity: 1/case
Compatible Respirator: 256-02-01
Intrinsically Safe: No
Product Color: Blue
Product Series: Supplied Air
Product Type: Air Filter & Regulator Panel
Prote

3M™ Breathe Easy™ PAPR Systems

Details

NIOSH-approved PAPR system helps provide respiratory protection from certain airborne contaminants

Loose-fitting, butyl rubber hood provides respiratory protection without the need for fit testing

Kits include a hood, motor blower, breathing tube, battery, airflow indicator, belt, and cartridge; some kits may have additional components

Headgear used as part of certain PAPRs can accommodate workers with limited facial hair and prescription eyewear

Typical properties

Battery Life: 12 Hour, 5.5 to 13 hours

Battery Type: Non-Rechargeable Lithium-ion, None, Standard Capacity Lithium Ion - Rechargeable

Belt Type: Decon, None, Standard

Brands: 3M™

Breathing Tube Type: Back-Mounted

Cartridge or Filter Included: No, Yes

3M™ Full Facepiece Reusable Respirator 7800S-S, Small, Silicone 1 EA/Case

3M Product Number 7800S-S 3M ID 7000126199 UPC 00051138542573

Details

Recommended for use in multiple industries including construction, general manufacturing, heavy infrastructure, industrial maintenance, mining, oil and gas, welding, and more

Meets the requirements of ANSI Z87.1-2003 standard for eye and face protection

Silicone face seal helps provide comfort and durability, and is easy to clean

Six-strap harness helps provide a secure comfortable fit

Use with 3M™ Particle Filters 2000, 2200, 7000, or 5000 Series to help filter certain particulates

Use with 3M 6000 Series Gas/Vapor Cartridges to help filter a broad range of gases and vapors

Use with 3M 6000 Series Combination Cartridges to help filter particulates in addition to gases and vapors

Compatible with 3M™ TR-600 and TR-800 powered air and Dual Airline supplied air systems against a variety of gases, vapors, and particulate hazards

For workplace/occupational use only

Typical properties

Accessories: Yes

Assigned Protection Factor: 10 Qualitative Fit Test, 50 Quantitative Fit Test

Brands: 3M™

Cartridge or Filter Included: No

Case Quantity: 1/case

Clip-on Welding Shield: Yes

Compatible with 3M™ PAPR Systems: Yes

Compatible with 3M™

3M™ Eyeglass Frame and Mount 7894/7894-AM, Accessory, with Case 1 EA/Case

3M Product Number 7894 3M ID 7000125980 UPC 00021200603792

Details

Use with 3M™ Full Facepiece Respirators 7000 Series
Permits the wearer to use corrective lenses and to make position adjustment that
is most comfortable
1 each per case
For occupational use only

Typical properties

Accessories: No
Boxes per Case: 1
Brands: 3M™
Case Quantity: 1/case
Clip-on Welding Shield: No
Compatible with 3M™ PAPR Systems: No
Compatible with 3M™ Supplied Air System: No
Compatible with Welding Shield: No
Cool Flow™ Exhalation Valve: No
Dro

3M™ Removable DIN Connector 7886, Replacement Part 2 EA/Case

3M Product Number 7886 3M ID 7000130998 UPC 50051138214208

Details

Approved 3M replacement part

Designed for use with side inlet ports of 3M Full Facepieces 7800S (sold separately)

Maintains original performance standards of facepiece

Weighs only 4.5 ounces

Replaceable part can potentially result in respiratory equipment cost savings

Typical properties

Accessories: No

Brands: 3M™

Case Quantity: 2/bag

Clip-on Welding Shield: No

Compatible with 3M™ PAPR Systems: No

Compatible with 3M™ Supplied Air System: No

Compatible with Welding Shield: No

Cool Flow™ Exhalation Valve: No

Drop-down Feature: No

3M™ Quick Latch Respirator with Cool Flow™ Valve Paint Project #6503QL (LARGE)

3M ID 70009124663 UPC 00638060857786

Details

NIOSH-APPROVED OV/AG/P100 CARTRIDGE filters at least 99.97% of solids and liquid aerosols, as well as oil-based particulates

HELPS REDUCE EXPOSURE to certain organic vapors encountered during activities involving latex and oil-based painting, including paint spraying, varnishes, stains, sealants, solvents, certain solvent-based cleaners or pesticides**

FOR WORKPLACE/OCCUPATIONAL USE ONLY

HELPS REDUCE EXPOSURE to certain organic vapors encountered during activities involving latex and oil-based painting, including paint spraying, varnishes, stains, sealants, solvents, certain solvent-based cleaners or pesticides**

ALSO HELPS REDUCE EXPOSURE against certain acid gases such as heavy-duty cleaners/bleach, sealants and pool chemicals/treatments

QUICK LATCH SYSTEM for easy, one handed- on/off and makes it easy to drop respirator down from face without removing straps in a non-contaminated area

KIT CONTENTS: one facepiece, one pair of replaceable organic vapor/acid gas/P100 particulate filters (#60923)

VALVE COVER DESIGN directs exhaled breathe and moisture downward
CONVENIENT, REUSABLE DESIGN

DURABLE DESIGN for lasting wear

LIGHTWEIGHT, SILICONE FACESEAL for premium comfort

6001 OV CARTRIDGE HELPS REDUCE EXPOSURE to certain organic vapors encountered during activities involving latex and oil-based painting, including paint spraying*, varnishes, stains, sealants, solvents, certain solvent-based cleaners or pesticides**. *Use a prefilter when spraying **Refer to Pesticide Product Label for Respirator Guidance or call 3M at 1-800-243-4630 or In Canada, call 1-800-267-4414

5P71 FILTER HELPS REDUCE EXPOSURE to certain particles from paint spraying*, spray adhesives and pesticides**. *Use a prefilter when spraying **Refer to Pesticide Product Label for Respirator Guidance or call 3M at 1-800-243-4630 or In Canada, call 1-800-267-4414

3M™ BAYONET CONNECTION compatible with 3M™ cartridges and filters
KIT CONTENTS: one facepiece, one pair of replaceable 6001 Organic Vapor cartridges, one pair of 501 retainers and two pairs of replaceable 5P71 particle filters

Typical properties

Brands: 3M™

Catalog Number: 6503QLP1-DC-PS

Factory ISO Certification: No ISO Certification information available

eClass 14 Classification Group: 40220112

3M™ Rugged Comfort Half Facepiece Reusable Respirator 6503/49491, Large, 10 EA/Case

3M Product Number 6503 3M ID 7000128240 UPC 50051131494911

Details

Recommended industries include construction, general manufacturing, heavy infrastructure, industrial maintenance, mining, oil and gas, transportation, and more

Use with 3M™ Particle Filters 2000, 2200, 7000, or 5000 Series to filter certain particulates

Use with 3M 6000 Series Gas/Vapor Cartridges to help filter a broad range of gases and vapors

Use with 3M 6000 Series Combination Cartridges to help filter particulates in addition to gases and vapors

Compatible with 3M™ TR-600 and TR-800 powered air purifying respirators and Dual Airline supplied air systems against a variety of gases, vapors, and particulate hazards

Silicone face seal keeps its shape even in hot work conditions

Low-profile half facepiece design is compatible with many welding and grinding shields

For workplace/occupational use only

Typical properties

Accessories: No

Assigned Protection Factor: 10

Brands: 3M™

Case Quantity: 10/case

Clip-on Welding Shield: No

Compatible With: Line Compressed Air System SA Series

Compatible with 3M™ PAPR Systems: No

Compatible with 3M™ Supplied Air System: No

Com

3M™ Rugged Comfort Half Facepiece Reusable Respirator 6501/49487, Small, 10 EA/Case

3M Product Number 6501 3M ID 7000128236 UPC 50051131494874

Details

Recommended industries include construction, general manufacturing, heavy infrastructure, industrial maintenance, mining, oil and gas, transportation, and more

Use with 3M™ Particle Filters 2000, 2200, 7000, or 5000 Series to filter certain particulates

Use with 3M 6000 Series Gas/Vapor Cartridges to help filter a broad range of gases and vapors

Use with 3M 6000 Series Combination Cartridges to help filter particulates in addition to gases and vapors

Compatible with 3M™ TR-600 and TR-800 powered air purifying respirators and Dual Airline supplied air systems against a variety of gases, vapors, and particulate hazards

Silicone face seal keeps its shape even in hot work conditions

Low-profile half facepiece design is compatible with many welding and grinding shields

For workplace/occupational use only

Typical properties

Accessories: No

Assigned Protection Factor: 10

Brands: 3M™

Case Quantity: 10/case

Clip-on Welding Shield: No

Compatible With: Line Compressed Air System SA Series

Compatible with 3M™ PAPR Systems: No

Compatible with 3M™ Supplied Air System: No

Com

3M™ Speedglas™ G5-03 Pro Hard Hat Adapter 10-0714-00, for H-700 Series Hard Hats

3M Product Number 10-0714-00 3M ID 7100312633 UPC 00638060430620

Details

Flexibility

All mounting hardware included

Allows for easy integration of headcover for welding

One adapter per case

Applications include assembly, facility maintenance, grinding, machine operations, sanding, and welding

For use in the construction, heavy infrastructure, and industrial maintenance industries

Typical properties

Brands: Speedglas™

Compatible Hard Hat: H-700

Compatible Welding Helmet: G5-03 Series

Part Type: Accessory

Product Series: G5

Product Type: Hard Hat Adapter

eClass 14 Classification Group: 40300190

3M™ Speedglas™ G5-03 Pro Hard Hat Adapter 10-5014-00, for X-5000 Series Hard Hats

3M Product Number 10-5014-00 3M ID 7100312232 UPC 00638060430637

Details

Flexibility

All mounting hardware included

Allows for easy integration of headcover for welding

One adapter per case

Applications include assembly, facility maintenance, grinding, machine operations, sanding, and welding

For use in the construction, heavy infrastructure, and industrial maintenance industries

Typical properties

Brands: Speedglas™

Compatible Hard Hat: X5000

Compatible Welding Helmet: G5-03 Series

Part Type: Accessory

Product Series: G5

Product Type: Hard Hat Adapter

eClass 14 Classification Group: 40300190

3M™ Speedglas™ Hard Hat 27-0099-72, for 9100MP Welding Helmets, 1 EA/Case

3M Product Number 27-0099-72 3M ID 7000128227

Details

Adjustable adaptor attaches 3M™ Speedglas™ Welding Helmet 9100 and 9100 FX to most hard hats
All mounting hardware included
Allows for easy integration of headcover for welding
One adapter per case
Applications include assembly, facility maintenance, grinding, machine operations, sanding, and welding
For use in the construction, heavy infrastructure, and industrial maintenance industries

Typical properties

Brands: Speedglas™
Case Quantity: 1
Compatible Welding Helmet: 9100 MP Welding Helmets
Features: Respiratory Accessory
For Use With: 3M™ Speedglas™ 9100MP Welding Helmets
Headgear Type: Hard Hats
Product Color: Black
Product Series: 9100, 9100 MP,

3M™ PROTECTA® Cable Anchorage Extensions

Details

Portable and reusable

Meets the requirements for ANSI/ASSP Z359.18, 29 CFR OSHA 1910.140 and 29 CFR OSHA 1926.502

Recommended for use in multiple industries including construction, mining, and oil and gas

Compact and lightweight design

High strength steel O-ring hardware

Variable length 1/4 in. vinyl coated galvanized cable anchor extension with snap hook at one end, O-ring at other

Durable 1/4 in. (6.3 mm) 7x19 galvanized steel cable with vinyl jacket

High strength self locking snap hook at one end

Typical properties

Anchor Install Type: Reusable

Attachment Type: Hook

Carabiner/Hook Material: Zinc Plated Steel

Case Quantity: 1

Connected Safety ID Equipped: No

Install Type: Reusable

Material: Galvanized Steel

Product Color: Silver

Product Series: PRO™

Product

Dimensions and Classifications

Overall Length (Imperial): 2 ft, 3 ft, 4 ft, 6 ft, 8 ft, 10 ft

3M™ DBI-SALA® Manhole Collar Davit Base

Details

Welded aluminum construction
Built-in carrying handles make it transportable
Set up and dismantle without tools
Recommended for use in any industry requiring access to manholes
Available in multiple sizes to fit a wide range of manhole diameters
Accommodates offset davit masts

Typical properties

Case Quantity: 1
Connected Safety ID Equipped: No
Dimensions: (41.00x10.90x15.00)lbs
Install Type: Portable
Material: Aluminum
Net Weight (Imperial): 35.5 lb, 37 lb, 39 lb
Net Weight (Metric): 16.1 kg, 16.8 kg, 17.8 kg
Product Color: Green
Product

3M™ Readers Safety Glasses 91191H1-C, +1.5 Blk Frm, Clr Lens

3M ID 70006985660 UPC 00078371911911

Details

Clear lenses
Adjustable temple lengths
Reader lenses available (+1.5)
Meets the requirements of ANSI Z87.1-2003 and CSA Z94.3-2007
Quantity: 1

Typical properties

Brands: 3M™
Catalog Number: 91191H1-C
Factory ISO Certification: No ISO Certification information available
Frame Material: Polycarbonate
Frame Style: Wraparound
Magnifying Diopter: 1.5X
Material: Polycarbonate
Product Color: Black
Seal Type: No S

Dimensions and Classifications

Overall Height (Imperial): 4 in
Overall Height (Metric): 101.6 mm
Overall Length (Imperial): 2 in
Overall Length (Metric): 50.8 mm
Overall Width (Imperial): 8 in
Overall Width (Metric): 203.2 mm

3M™ Readers 2.5X Safety Eyewear, Black Frames, Clear lens

3M ID 70006985686 UPC 00078371911935

Details

Clear lenses
Adjustable temple lengths
Reader lenses available (+2.5)
Meets the requirements of ANSI Z87.1-2003 and CSA Z94.3-2007
Quantity: 1

Typical properties

Brands: 3M™
Catalog Number: 91193H1-C
Factory ISO Certification: No ISO Certification information available
Frame Material: Polycarbonate
Frame Style: Wraparound
Magnifying Diopter: 2.5X
Material: Polycarbonate
Product Color: Black
Seal Type: No S

Dimensions and Classifications

Overall Height (Imperial): 4 in
Overall Height (Metric): 101.6 mm
Overall Length (Imperial): 2 in
Overall Length (Metric): 50.8 mm
Overall Width (Imperial): 8 in
Overall Width (Metric): 203.2 mm

3M™ Readers 2.0X Safety Eyewear, Black Frames, Clear lens

3M ID 70006985678 UPC 00078371911928

Details

Clear lenses
Adjustable temple lengths
Reader lenses available (+2.0)
Meets the requirements of ANSI Z87.1-2003 and CSA Z94.3-2007
Quantity: 1

Typical properties

Brands: 3M™
Catalog Number: 91192H1-C
Factory ISO Certification: No ISO Certification information available
Frame Material: Polycarbonate
Frame Style: Wraparound
Magnifying Diopter: 2.0X
Material: Polycarbonate
Product Color: Black
Seal Type: No S

Dimensions and Classifications

Overall Height (Imperial): 4 in
Overall Height (Metric): 101.6 mm
Overall Length (Imperial): 2 in
Overall Length (Metric): 50.8 mm
Overall Width (Imperial): 8 in
Overall Width (Metric): 203.2 mm

3M™ DBI-SALA® Confined Space Winch/SRL Mounting Bracket for UCT 10 ft Tripod 8512292

Part Number 8512292 3M Product Number 8512292 3M ID 7012494922

Details

Winch/SRL mating mounting bracket adaptor
Offers quick mount system to structure
Compact and lightweight design
Durable zinc plated steel construction

Typical properties

Brands: DBI-SALA®
Case Quantity: 1
Connected Safety ID Equipped: No
For Use With: 3M™ DBI-SALA® Confined Space UCT Aluminum Tripod 8513159
Net Weight (Imperial): 5.1 lb
Net Weight (Metric): 2.3 kg
Product Color: Silver
Recommended Industry: Constru

3M™ DBI-SALA® Winch/SRL Mating Mounting Bracket for UCT Tripod 8510207

Part Number 8510207 3M Product Number 8510207 3M ID 7100209338

Details

Winch/SRL mating mounting bracket adaptor
Offers quick mount system to structure
Compact and lightweight design
Durable zinc plated steel construction

Typical properties

Brands: DBI-SALA®
Case Quantity: 1
Connected Safety ID Equipped: No
Dimensions: 3.00x0.90x7.00in
Product Color: Yellow Zinc
Product Series: Advanced™
Product Type: Winch/SRL Mating Mounting Bracket
Recommended Industry: Construction, General Indust

3M™ Versaflo™ Standard Face Seal M-935/37325(AAD), 5 EA/Case

Part Number 37325 3M Product Number M-935 3M ID 7000127691

Details

Replacement faceseal for 3M™ Versaflo™ M-100, M-200, and M-300 Series products

Typical properties

Brands: Versaflo™

Case Quantity: 5

Compatible With: 3M™ Versaflo™ M-300 Parts & Accessories

Headgear Type: Headcover

High Heat: No

Material: Polypropylene Coated Non-woven Polypropylene

Product Color: White

Product Series: M-Series

Product Type: F

3M™ Versaflo™ Flame Resistant Face Seal M-937, 5 EA/Case

3M Product Number M-937 3M ID 7100077228 UPC 00051131173316

Details

For use on M-100, M-200, and M-300 Series head tops
Made of flame-resistant polyester

Typical properties

Brands: Versaflo™

Case Quantity: 5

Compatible With: 3M™ Versaflo™ M-300 Parts & Accessories

Headgear Type: Headcover

High Heat: Yes

Material: Flame Resistant Polyester

Product Color: Black

Product Series: M-Series

Product Type: Face Seal

3M™ Versaflo™ Comfort Face Seal M-936/37326(AAD), 5 EA/Case

Part Number 37326 3M Product Number M-936 3M ID 7000127692

Details

For use on M-100, M-200, and M-300 Series head tops

Typical properties

Brands: Versaflo™

Case Quantity: 5

Compatible With: 3M™ Versaflo™ M-300 Parts & Accessories

Headgear Type: Headcover

High Heat: No

Material: Polyurethane Coated Knitted Polyamide Fabric

Product Color: Black

Product Series: M-Series

Product Type: F

3M™ Faceshield Cover H-111-100/07043(AAD), 100 ea/Bag

3M ID 7100138629 UPC 50051131070436

Details

For use with 3M™ Hoods H-Series

Typical properties

Brands: 3M™

Compatible With: 3M™ H-Series Headgear

Product Type: Faceshield Cover

3M™ PELTOR™ WS™ LiteCom PRO III Headsets

Details

VOICE OPERATED TRANSMISSION: Voice operated transmission (VOX) for hands free operation in high noise environments

BUILT-IN PROGRAMMABLE ANALOG AND DIGITAL TWO-WAY

COMMUNICATION RADIO: Headset-to-headset communication with ability to be integrated with similar professional radio communication systems. Up to 70 programmable radio channels

NOISE CANCELING, WATER AND DUST PROOF SPEECH MICROPHONE

(IP67): Helps provide clear communication in noisy and demanding environments

HEARING PROTECTION: Noise attenuating ear cups help provide hearing protection in environments with potentially hazardous noise

COMFORT OPTIONS: Headset is available in both headband, neckband and hard hat attached configurations

Typical properties

Attenuation Rating: 25 dB, 28 dB, 27 dB

Audio Type: Communication

Auxiliary Port: 4-pin XLR

Battery Life: 11 Hours, 8 hr - 12 hr, Approx. 11 Hours

Battery Type: Lithium-Ion, Rechargeable Li-ion Pack

Bluetooth: Yes

Brands: PELTOR™

Built In FM and or A

3M™ DBI-SALA® Equipment Carrying and Storage Bag 9503806, 10.5 in x 12 in x 19.5 in

Part Number 9503806 3M Product Number 9503806 3M ID 7012691199

Details

Bag sizes to accommodate user needs
Keep your fall protection equipment together
Keep your fall protection equipment stored away from dirt and debris

Typical properties

Brands: DBI-SALA®
Case Quantity: 1
Connected Safety ID Equipped: No
Dimensions: 10.50x12.00x19.50in
Product Color: Blue
Product Type: Equipment Carrying & Storage Bag
Recommended Industry: Construction, General Industrial, Oil & Gas, Transportation,

Dimensions and Classifications

Overall Length (Imperial): 10.5 in
Overall Length (Metric): 26.7 cm
Overall Width (Imperial): 19.5 in
Overall Width (Metric): 49.5 cm

3M™ DBI-SALA® Equipment Carrying/Storage Bag 9506162, 9 in x 9 in x 30 in

Part Number 9506162 3M Product Number 9506162 3M ID 7100231989

Details

Bag sizes to accommodate user needs
Keep your fall protection equipment together
Keep your fall protection equipment stored away from dirt and debris

Typical properties

Brands: DBI-SALA®
Case Quantity: 1
Connected Safety ID Equipped: No
Dimensions: 9.00x9.00x30.00in
For Use With: Rescue & Descent Devices
Net Weight (Imperial): 2 lb
Net Weight (Metric): 0.9 kg
Product Color: Blue, Yellow
Product Type: Equipment Ca

Dimensions and Classifications

Overall Length (Imperial): 12 in
Overall Length (Metric): 30.5 cm
Overall Width (Imperial): 12 in
Overall Width (Metric): 30.5 cm

3M™ Protecta® Lanyard

Details

Ideal for work positioning or restraint
Abrasion resistant polyester webbing
User friendly self locking snap hooks at each end

Typical properties

Anchor Connection Type: Snap Hook
Anchor Hook Material: Zinc Plated Steel
Anchor Hook Material: Zinc Plated Steel
Case Quantity: 1
Connected Safety ID Equipped: No
Energy Absorber Class: None
Harness Connection Hook Material: Zinc Plated Steel
Harn

Dimensions and Classifications

Overall Length (Imperial): 3 ft, 6 ft

3M™ Test Hood FT-14, 10 ea/Case

3M Product Number FT-14 3M ID 7000051788 UPC 50051138163537

Details

Hood used for qualitative fit testing
Used with the 3M™ Qualitative Fit Test Apparatus FT-10, FT-20 and FT-30
Can be used to check face-to-respirator seal on any particulate respirator or
gas/vapor respirator with a particulate prefilter
For Occupational Use Only

Typical properties

Brands: 3M™
Case Quantity: 10
Clinical Area: Emergency Room
For Use With: FT-10, FT-20, FT-30
Product Type: Test Hood
Recommended Application: Fit Testing
Specifications Met: CE Approved
Test Format: Qualitative
eClass 14 Classification Group: 402

3M™ Collar FT-15, 1 ea/Case

3M Product Number FT-15 3M ID 7000051789 UPC 00051138163549

Details

Collar for fit testing; to be used in conjunction with 3M™ Test Hood FT-14
Used with the 3M™ Qualitative Fit Test Apparatus FT-10, FT-20 and FT-30
Can be used to check face-to-respirator seal on any particulate respirator or
gas/vapor respirator with a particulate prefilter
For Occupational Use Only

Typical properties

Brands: 3M™
Case Quantity: 1
Clinical Area: Emergency Room
Product Type: Collar
Purpose: Parts and Accessories
Recommended Application: Fit Testing
Specifications Met: OSHA
Test Format: Qualitative
eClass 14 Classification Group: 40220190

3M™ Virtua™ Protective Eyewear

Details

Unisex style

An economical eyewear option

Lightweight construction helps ensure wearer comfort

Wraparound design provides extended eye protection and unobstructed viewing

U6 rated polycarbonate lenses absorb 99.9% of UVA, UVB, and UVC rays between 200 nm and 380 nm

Typical properties

Anti Fog Lens: No

Brands: Virtua™

Case Quantity: 100,20

Class: Economy

Comfort Features: Lightweight, Wraparound lens

Eyewear Range: Economy

Frame Color: Clear, Gray, Light Gray

Frame Material: Plastic

Frame Style: Frameless

Hard Coat Lens: Yes

3M™ Nuvo™ Reader Safety Glasses

Details

“Retro” styling gives the glasses a nostalgic look
Integral brow bar and side shields offer additional protection
Dual lens profile in a one-piece lens design combines style with durability
Polycarbonate lenses absorb 99.9% UV

Typical properties

Anti Fog Lens: No
Case Quantity: 20
Class: Value
Comfort Features: Adjustable length temples, Integral sideshields and brow bar,
Soft adjustable nose bridge
Diopter: 1.5, 2.0, 2.5
Eyewear Range: Value
Frame Color: Gray
Frame Material: Plastic
Fram

3M™ DBI-SALA® Rollgliss™ R350 3:1 Rescue & Positioning Device

Details

Rescue and positioning kit with pulleys, anchor sling, carabiner, and carrying bag
Designed for raising, lowering, and positioning
3/8 in. (9.5 mm) kernmantle rope lifeline comes in varying lengths: 50 ft. (15.2 m), 100 ft. (30.5 m), 200 ft. (61.0 m), and 300 ft. (91.4 m)
Manual control makes the ascent and descent smooth and secure
Pre-rigged system makes the job more efficient
Visual and audible function controls
Corrosion-resistant construction is compact but strong
Rope retention bar for added smooth operation

Typical properties

Case Quantity: 1
CoWorker Controlled Ascent: Yes
CoWorker Controlled Descent: Yes
Connected Safety ID Equipped: No
Descent Type: Vertical
Lifeline Material: Kernmantle, Braided Polyester Cover with Nylon Filament Core
Line Length (Imperial): 50 ft

Dimensions and Classifications

Overall Length (Imperial): 50 ft, 100 ft, 300 ft

3M™ DBI-SALA® Temporary Cable Horizontal Lifeline HLL Lifeline Assembly

Details

Durable galvanized lifeline

Portable design is durable, yet lightweight, for easy transport

Built-in, turnbuckle tensioner helps your worker tension the system to the required level

Stanchions and bases sold separately

This safety equipment is intended for use with additional personal protective equipment (PPE)

Recommended for use in multiple industries including construction, facilities, power plants, general manufacturing, heavy infrastructure, and more

Equipped with RFID

Metal energy absorbers, help protect the structure, and minimize needed fall clearance

Steel carabiners are easy to use, self locking and closing, and provide quick and safe attachment

Typical properties

Case Quantity: 1

Connected Safety ID Equipped: Yes

Install Type: Temporary/Portable

Lifeline Length (Imperial): 20 ft, 40 ft, 60 ft, 80 ft, 100 ft, 120 ft, 140 ft, 160 ft, 180 ft, 200 ft, 220 ft, 240 ft, 260 ft, 280 ft, 300 ft

Lifeline Length (Metric)

Dimensions and Classifications

Overall Length (Imperial): 20 ft, 40 ft, 60 ft, 80 ft, 100 ft, 120 ft, 140 ft, 160 ft, 180 ft, 200 ft, 220 ft, 240 ft, 260 ft, 280 ft, 300 ft

Overall Length (Metric): 6 m, 12 m, 18 m

3M™ Protecta® Synthetic Horizontal Lifeline System without Anchor Straps

Details

Synthetic horizontal lifeline systems without anchor
60 ft. (18.3 m) in length

Comes with tensioner, two 6 ft (1.8 m) tie off adapters and a transport bag

Typical properties

Case Quantity: 1

Connected Safety ID Equipped: No

Install Type: Temporary/Portable

Lifeline Hook Material: Zinc Plated Steel

Lifeline Length (Imperial): 60 ft

Lifeline Length (Metric): 18.28 m

Lifeline Material: Web

Maximum Number of Workers: 2

Ne

Dimensions and Classifications

Overall Length (Imperial): 60 ft

Overall Length (Metric): 18.3 m

3M™ DBI-SALA® FlexiGuard™ A-Frame System, Fixed Height

3M ID B00036705

Details

Multiple height and width configurations available

Aluminum and steel construction

Extruded aluminum rail requires minimal maintenance and includes two trolleys

System includes steel leveling jacks

Conforms to the requirements of OSHA 1926.502 and OSHA 1910.66

Suitable for numerous applications within the transportation, construction, utilities, and mining industries

Typical properties

Brands: DBI-SALA®

3M™ W Series Face Shields & Visors

Details

Helps workers see clearly

A variety of material options are available

It is recommended that protective eyewear be worn under faceshields at all times

Suggested for use in multiple industries including automotive, transportation, construction, manufacturing, mining, facility sanitation, heavy infrastructure, oil and gas, pharmaceutical, and more

Meets the requirements of ANSI Z87.1

Typical properties

Brands: 3M™

Case Quantity: 25,50,10

Features: UV Protection

For Use With: 3M™ Headgear Systems

Product Type: Faceshield, Faceshield Window, Short Faceshield

Recommended Application: Assembly, Cleaning, Demolition, Electrical, Exterior Assembly, Facil

Dimensions and Classifications

Overall Height (Imperial): 7.5 in, 9 in

Overall Height (Metric): 19 cm, 23 cm

Overall Length (Imperial): 14.5 in, 18.25 in

Overall Length (Metric): 36.83 cm, 46.36 cm

Overall Width (Imperial): 4 in, 8 in, 14.5 in

Overall Width (Metric): 10.16 cm, 20.

3M™ Chin Strap for Premium Head Suspension S-958/37252(AAD) 4 EA/Case

3M Product Number S-958 3M ID 7000127464 UPC 00051131372528

Details

Accessory for S-950 Premium Head Suspension
Not required for the safe operation of head gear

Typical properties

Brands: 3M™
Compatible With: 3M™ Premium Head Suspension, S-950
Headgear Type: Hood
High Heat: No
Product Series: S-Series
Product Type: Suspension
Recommended Industry: Marine

3M™ Powerflow™ Replacement Motor Blower Assembly 024-00-02R01, 1 ea/Case

3M Product Number 024-00-02R01 3M ID 7000126344 UPC 00051138722036

Details

Component of the 3M™ Powerflow™ System 240-01-00LBC
Lightweight

Typical properties

Brands: Powerflow™
CFM Capacity per Minute: 50 CFM
Case Quantity: 1/case
Compatible With: 3M™ Powerflow™ PAPR
Headgear Type: Full Facepiece
Intrinsically Safe: N/A
Product Color: Gray
Product Series: Powerflow
Product Type: Blower

3M™ Breathe Easy™ Turbo Replacement Motor Blower Assembly and Filter

Carrier 022-45-00R01, 1 EA/Case

3M Product Number 022-45-00R01 3M ID 7000126308 UPC 00051138663117

Details

This assembly is a replacement part for the 3M™ Turbo Unit used on 3M™ Breathe Easy™ Systems
Includes the cable assembly and blower unit kit

Typical properties

Brands: Breathe Easy™
Case Quantity: 1/case
Compatible With: 3M™ Breathe Easy™ PAPR
Product Color: Black
Product Series: Breathe Easy
Product Type: Blower

3M™ Replacement Blower TR-301N+, for Versaflo™ TR-300N+ 1 EA/Case

3M Product Number TR-301N+ 3M ID 7100153842 UPC 00076308942625

Details

Available as a replacement blower
Two selectable flow rate options - 6.5 CFM and 7.2 CFM
Easy-to-use and versatile PAPR for particulate environments
Offers more options and comfort to the user

Typical properties

Battery Life: 6 hr
Battery Type: Economy Battery
Brands: Versaflo™
Breathing Tube Type: Back-Mounted
Case Quantity: 1/pack
Compatible With: 3M™ Versaflo™ TR-300 Series PAPR, 3M™ Versaflo™ TR-300N+ Series PAPR
Headgear Type: Head Cover with Suspensio

3M™ Protecta® Positioning and Restraint Lanyard

Details

Variety of hardware options available
Variety of lifeline material options available
Select models equipped with impact indicator

Typical properties

Anchor Connection Type: Rebar Hook
Anchor Hook Material: Zinc Plated Steel
Anchor Hook Material: Zinc Plated Steel
Case Quantity: 1
Connected Safety ID Equipped: No
Energy Absorber Class: None
Harness Connection Hook Material: Zinc Plated Steel
Har

Dimensions and Classifications

Overall Length (Imperial): 22 in, 24 in

3M™ E-A-R™ Push-Ins™ Earplugs

Details

Noise reduction rating (NRR)*: 28 dB

Hold the flexible fitting stem to insert the ear tip and help keep it clean longer even when hands are dirty

Smooth surface of soft E-A-Rform™ foam ear tip helps the ear tip slide into place for a comfortable fit

Compatible with the 3M™ E-A-Rfit™ Validation System

Available with or without cords to suit user preference

CSA Class AL

*U.S. EPA specifies the NRR as the measure of hearing protector noise reduction. However, 3M makes no warranties as to the suitability of the NRR for this purpose. 3M strongly recommends personal fit testing of hearing protectors. Research suggests that users may receive less noise reduction than indicated by the attenuation label value(s) on the packaging due to variation in fit, fitting skill, and motivation of the user. Refer to applicable regulations or guidance on how to adjust attenuation label values. It is recommended that the NRR be reduced by 50% to better estimate typical protection

Typical properties

Attenuation Rating: 28.0 Decibel,30.0 Decibel

Banded: No

Case Quantity: 1500 Pair,2000 Pair,400 Pair

Cord Color: Blue

Cord Material: Metal Detectable Cord, Vinyl

Cord Type: Metal Detectable Cord, None, Vinyl

Corded: No, Yes

Dielectric: No

Dispense

3M™ E-A-R™ UltraFit™ Earplugs

Details

Stem helps users insert earplug into their ear canals

No need to touch the ear tips during earplug insertion, helping to keep ear tips clean longer

Soft polymer is washable and reusable

Compatible with the 3M™ E-A-Rfit™ Validation System

Noise reduction rating (NRR)*: 25 dB for standard Ultrafit and 27 dB for Ultrafit 27 CSA Class AL

*U.S. EPA specifies the NRR as the measure of hearing protector noise reduction. However, 3M makes no warranties as to the suitability of the NRR for this purpose. 3M strongly recommends personal fit testing of hearing protectors. Research suggests that users may receive less noise reduction than indicated by the attenuation label value(s) on the packaging due to variation in fit, fitting skill, and motivation of the user. Refer to applicable regulations or guidance on how to adjust attenuation label values. It is recommended that the NRR be reduced by 50% to better estimate typical protection

Vinyl or cloth material options for cords

Typical properties

Attenuation Rating: 25.0 Decibel

Attenuation Rating (SNR): 32 Decibel

Banded: No

Brands: E-A-R™

Case Quantity: 320 Pair, 2000 Pair, 200 Pair, 400 Pair, 500 Pair

Cord Color: Blue, Red, White

Cord Material: Cloth, Vinyl

Cord Type: Metal Detectable Cord,

Dimensions and Classifications

Overall Height (Imperial): 9.1 in

Overall Height (Metric): 23.11 cm

Overall Length (Imperial): 21.9 in

Overall Length (Metric): 55.63 cm

Overall Width (Imperial): 8.7 in

Overall Width (Metric): 22.1 cm

3M™ Nylon Mesh Faceshield V1B-10P, Black 10 EA/Case

3M Product Number V1B-10P 3M ID 7000103809 UPC 10093045936172

Details

Nylon mesh is good for forestry applications
Approximately 6.5" x 11.5"
Protection against flying debris and particles
Mesh provides ventilation

Typical properties

Brands: PELTOR™
Case Quantity: 10
For Use With: 3M™ Peltor™ Cap-mounted Earmuffs, 3M™ Peltor™ Hard Hat Adapter P3EV/2
Product Type: Faceshield
Recommended Application: Assembly, Cleaning, Demolition, Electrical, Facility Maintenance, Grinding, Machine

Dimensions and Classifications

Overall Height (Imperial): 6.5 in
Overall Height (Metric): 16.5 cm
Overall Length (Imperial): 11.5 in
Overall Length (Metric): 29.21 cm
Overall Width (Imperial): 6.5 in
Overall Width (Metric): 16.51 cm

3M™ Metal Mesh Faceshield V1A-10P, Black 10 EA/Case

3M Product Number V1A-10P 3M ID 7000103808 UPC 10093045936165

Details

Metal mesh is good for forestry applications
Approximately 6.5" x 11.5"
Protection against flying debris and particles
Mesh provides ventilation

Typical properties

Brands: PELTOR™
Case Quantity: 10
For Use With: 3M™ Peltor™ Cap-mounted Earmuffs, 3M™ Peltor™ Hard Hat Adapter P3EV/2
Product Type: Faceshield
Recommended Application: Assembly, Cleaning, Demolition, Electrical, Facility Maintenance, Grinding, Machine

Dimensions and Classifications

Overall Height (Imperial): 6.5 in
Overall Height (Metric): 16.5 cm
Overall Length (Imperial): 11.5 in
Overall Length (Metric): 29.21 cm
Overall Width (Imperial): 6.5 in
Overall Width (Metric): 16.51 cm

3M™ X5-SWBD01 Black/Grey Replacement Sweat Band for SecureFit™ Safety Helmet

3M Product Number X5-SWBD01 3M ID 7100180680

Details

Can be removed for cleaning

Fits 3M SecureFit™ Safety Helmet series X5000 and X5500
washable

3M™ SecureFit™ X5000 Safety Helmet Pressure Diffusion Ratchet Suspension
fits hat sizes 6-1/4 to 7-7/8 inches (50 to 63 cm) head circumference

Typical properties

Brands: SecureFit™

Case Quantity: 10

Compatible Hard Hat: X5000, X5500

For Use With: 3M™ Safety Helmet

Material: Nylon

Product Color: Black, Gray

Product Series: X5000

Product Type: Sweatband

Recommended Application: Construction, Demolition, Faci

3M™ Speedglas™ 9100-Air Welding Helmet 25-0099-35SW, with SideWindows and Extended Headcover, No ADF, 1 EA/Case

3M Product Number 25-0099-35SW 3M ID 7000128105 UPC 00051131498334

Details

9100-Air Headtop

No ADF Included

Adjustable head suspension for increased comfort, helmet stability and weight distribution

Side windows

Light-to-dark switching time of 0.1 ms

To be combined with 3M™ Adflo™ Powered air Respirator

Typical properties

ADF Dark State Shades: None

ADF Shade Range: None

Brands: Speedglas™

Case Quantity: 1

Features: Eye & Face Protection

Grinding Option: ADF with Grind Mode

Headgear Type: Respiratory Assembly, Welding Helmet

Lens Type: No Lens

Product Color: Black

3M™ Versaflo™ Head Neck and Shoulder Cover M-976/37332(AAD), for M-100 and M-300 Series Welding Helmets, 1 EA/Case

3M Product Number M-976 3M ID 7000030015

Details

For use on M-100, M-200, and M-300 Series head tops
Continuous coverage of the head, neck and shoulders
Does not provide additional respiratory protection

Typical properties

Brands: Versaflo™
Case Quantity: 1
Compatible With: 3M™ Versaflo™ M-300 Parts & Accessories
Headgear Type: Headcover
High Heat: No
Product Color: White
Product Series: M-Series
Product Type: Headgear
Recommended Industry: Marine

3M™ Versaflo™ Flame Resistant Headgear Cover M-972/37331(AAD), 1 EA/Case

3M Product Number M-972 3M ID 7000052877 UPC 00051131373310

Details

Made from Flame Resistant Polyester

Disposable item that should be discarded when damaged or soiled

Typical properties

Brands: Versaflo™

Case Quantity: 1

Compatible With: Versaflo™ M-Series

Headgear Type: Headcover

High Heat: Yes

Product Color: Black, Orange

Product Series: M-Series

Product Type: Headgear

3M™ Hood BE-10BR, (Formerly 522-02-23R01), Butyl Rubber, 1 EA/Case

3M Product Number BE-10BR 3M ID 7000131727 UPC 00051138720940

Details

Used for First Receiver, patient decontamination programs
Approved to the chemical, biological, radiological, and nuclear (CBRN) loose-fitting PAPR standard developed by the National Institute for Occupational Safety and Health (NIOSH) for gases and vapors
The high efficiency filters in a CBRN cartridge filter out 99.97% of particulates

Typical properties

Assigned Protection Factor: 1000
Brands: 3M™
CFM Capacity per Minute: 100 CFM, 50 CFM
Compatible With: 3M™ Breathe Easy Powered Air Purifying Respirator (PAPR) Systems
Fitting Type: Industrial Interchange
Headgear Type: Hood
High Heat: No
Product C

3M™ E-A-R™ Roll Model 319-1003, 1 EA/Case

3M Product Number 319-1003 3M ID 7100179589 UPC 00080529190031

Details

This hands-on device demonstrates the proper way to ensure your earplugs are the correct size and to aid in proper fitting and roll down of foam earplugs
1 EA Per Case

Training tool

*The NRR may overestimate the hearing protection provided during typical use

Typical properties

Brands: E-A-R™

Case Quantity: 1

Material: Acrylic

Product Color: Transparent

Product Series: E-A-R Support Materials

Product Type: Roll Model

eClass 14 Classification Group: 40270102

3M™ Specialty Particulate Respirators 8000 Cup Series

Details

Designed to meet NIOSH certification standards
Some models available with 3M™ Cool Flow™ Exhalation Valve to help release warm and moist exhaled breath from inside the respirator
Adjustable noseclip options help provide a custom and secure seal
Some models available with fully adjustable buckle straps or dual elastic headbands for maximum comfort and effectiveness
3M proprietary filter media designed for ease of breathing
Some models available with Activated Carbon Filter layer for the control of nuisance level organic vapors*
Some models available with flame resistant layers for applications such as welding or soldering which combines with cake resistant filter media to help prevent caking of particles when sanding or grinding

Typical properties

Acid Gas Reduction: No, Yes
Advanced Electrostatic Media: Yes
Braided Comfort Strap: No, Yes, Yes (Wide)
Cake-Resistant Filter Media: No, Yes
Class: Comfort Plus, Specialty
Cool Flow™ Exhalation Valve: No, Yes
Enhanced Comfort: No, Yes
Environment

3M™ PELTOR™ X2 Earmuffs X2B, Behind-the-Head, 10 EA/Case

3M Product Number X2B 3M ID 7100123156 UPC 10078371671263

Details

Design of neckband allows earmuffs to be worn with a variety of face shields and headgear

Compatible with headgear without accessory slots

Soft, adjustable head strap helps to maintain a secure fit with many different types of headgear

Fit can be confirmed: Verify with 3M™ E-A-Rfit™ Dual-Ear Validation System***

X2 products have medium attenuation: Perfect for the mid-level noise environments

Typical properties

Attenuation Rating: 25.0 Decibel

Attenuation Rating (SNR): 25 Decibel

Bluetooth: No

Brands: PELTOR™

Case Quantity: 10

Corded: No

Dielectric: No

Earmuff Style: Behind the Head

Electrically Insulated: No

Hearing Protection Style: Behind the Head, B

3M™ PELTOR™ X1 Hygiene Kit HYX1/37280(AAD), for X1 Earmuffs, 10 Kits EA/Case

3M Product Number HYX1 3M ID 7000104045 UPC 04046719723478

Details

Easily snaps into employee's own earmuffs enabling fit test. Adapter clips hold microphone next to earmuff for proper positioning during testing
Probed cushions can be cleaned with hygiene wipes and reused
Adapter clips hold microphones next to earmuffs during testing
*The NRR may overestimate the hearing protection provided during typical use

Typical properties

Brands: PELTOR™
Case Quantity: 10
Compatible Earmuff: X1-A, X1-P3E, X1-P51E, X1-P5E
Electrically Insulated: Yes
Hearing Protection Style: Hygiene Kit
Pairs Per Package: 1
Product Color: Black
Product Series: HYX1, X Series
Product Type: Hygiene Ki

3M™ PELTOR™ X2 Hygiene Kit HYX2/37281(AAD), for X2 Earmuffs, 10 Kits EA/Case

3M Product Number HYX2 3M ID 7000104046 UPC 04046719723492

Details

Easily snaps into employee's own earmuffs enabling fit test. Adapter clips hold microphone next to earmuff for proper positioning during testing
Probed cushions can be cleaned with hygiene wipes and reused
Adapter clips hold microphones next to earmuffs during testing
*The NRR may overestimate the hearing protection provided during typical use

Typical properties

Brands: PELTOR™
Case Quantity: 10
Compatible Earmuff: X2-A, X2-P3E, X2-P5E
Electrically Insulated: Yes
Hearing Protection Style: Hygiene Kit
Pairs Per Package: 1
Product Color: Black
Product Series: HYX2, X Series
Product Type: Hygiene Kit
Recomm

3M™ PELTOR™ X3 Hygiene Kit HYX3/37282(AAD), for X3 Earmuffs, 10 Kits EA/Case

3M Product Number HYX3 3M ID 7000104047 UPC 04046719723515

Details

Easily snaps into employee's own earmuffs enabling fit test. Adapter clips hold microphone next to earmuff for proper positioning during testing
Probed cushions can be cleaned with hygiene wipes and reused
Adapter clips hold microphones next to earmuffs during testing
*The NRR may overestimate the hearing protection provided during typical use

Typical properties

Brands: PELTOR™
Case Quantity: 10
Compatible Earmuff: X3-A, X3-B, X3-P3E, X3-P5E
Electrically Insulated: Yes
Hearing Protection Style: Hygiene Kit
Pairs Per Package: 1
Product Color: Black
Product Series: HYX3, X Series
Product Type: Hygiene Kit

3M™ E-A-R™ Clear Ear 319-1002, 1 EA/Case

3M ID 7000127216 UPC 10080529190021

Details

Clear Three Flange Design

Provides less noise protection than other earplugs, reducing over-attenuation and muffling effects sometimes associated with earplugs

Designed for entertainment and service industry professionals including performers, crew, wait staff, and security personnel

Soft, flexible polymer flanges seal the ear comfortably

Proven three flange design fits a wide range of ears

Typical properties

Brands: E-A-R™

Case Quantity: 1

Dispenser Available: No

Earplug Material: Silicone

Hearing Protection Style: Training Tools

Material: Silicone

Metal Detectable: No

Product Color: Transparent

Product Series: E-A-R Support Materials

Product Type: T

3M™ PELTOR™ COMTAC™ IV Hybrid Gel Ear Seals for Communication Headset, HY400, 1 EA/Case

3M Product Number HY400 3M ID 7010303881 UPC 00093045935994

Details

Replacement ear cushions for the 3M™ PELTOR™ COMTAC™ IV Headset
1 pair

Replace at least twice a year to ensure constant attenuation, hygiene and
comfort

Typical properties

Brands: PELTOR™

Intrinsically Safe: No

Level Dependent Function for Ambient Listening: Yes

Product Color: Black

Product Type: Hygiene Kit

Purpose: Military/Police

Recommended Industry: Military Tactical

Tactical Communication Protection System (TCA)

3M™ Versaflo™ Air Flow Indicator TR-971, for TR-600 PAPR, 1 EA

Part Number 56707 3M Product Number TR-971 3M ID 7100035846

Details

- Enables confirmation of airflow
- Confirms factory calibration of airflow
- Easy to use
- Works across multiple temperatures and altitudes

Typical properties

- Brands: Versaflo™
- Case Quantity: 1/pack
- Compatible With: 3M™ Versaflo™ TR-600 Series PAPR
- Product Color: Transparent
- Product Series: TR-600
- Product Type: Air Flow Indicator
- Recommended Application: Assembly & Mechanical, Construction, Facility Maint

3M™ Filter Bowl W-2915M, Aluminum 1 EA/Case

3M Product Number W-2915M 3M ID 7000126949 UPC 00051131985384

Details

Aluminum filter bowl used with the 3M™ Compressed Air Filter and Regulator Panel W-2806 for pressures less than 250 psig. For industrial applications and environments where chemicals or synthetic lubricants are present

Typical properties

Brands: 3M™

CFM Capacity per Minute: 100 CFM, 50 CFM

Product Color: Metal

Product Series: Supplied Air

Product Type: Filter Bowl

Supplied Air Respirator Style: W-Series Fixed Panels

3M™ Zero Gas Cylinder 529-05-18, 1 EA/Case

3M Product Number -500608 3M ID 7000131706 UPC 00051138720148

Details

Replacement zero gas cylinder for the 3M™ Calibration Kit 529-04-49
Contains 0.6 cubic feet of zero gas

Typical properties

Brands: 3M™

CFM Capacity per Minute: 100 CFM, 50 CFM

Case Quantity: 1/case

Product Color: Cream

Product Series: Supplied Air

Product Type: Gas Cylinder

Supplied Air Respirator Style: MST Portable and Fixed Panels

3M™ Zero Gas Cylinder 529-05-17, Large, 1 EA/Case

3M Product Number -500609 3M ID 7000126385 UPC 00051138727888

Details

Replacement cylinder for the 3M™ Calibration Kit 529-04-48
It contains 3.6 cubic feet of zero gas

Typical properties

Brands: 3M™
CFM Capacity per Minute: 100 CFM, 50 CFM
Case Quantity: 1/case
Product Color: Cream
Product Series: Supplied Air
Product Type: Gas Cylinder
Supplied Air Respirator Style: MST Portable and Fixed Panels

3M™ High Efficiency Filter Element W-3013-4/07009(AAD) 4/Case

3M Product Number W-3013-4 3M ID 7000130752 UPC 50051131070092

Details

Replacement filter for the 3M™ Coalescing Filter Assembly W-3012/37008(AAD)

Typical properties

Brands: 3M™

CFM Capacity per Minute: 100 CFM, 50 CFM

Compatible Respirator: W-2806

Product Color: Gray

Product Series: Supplied Air

Product Type: Filter

Protection Type: Particulate

Recommended Application: Assembly & Mechanical, Blasting, Cleaning

3M™ Versaflo™ Air Flow Indicator TR-973, for TR-600 PAPR with BT-63/64 Breathing Tube 1/case

3M Product Number TR-973 3M ID 7100167216 UPC 00051131277571

Details

- Enables confirmation of airflow
- Confirms factory calibration of airflow
- Easy to use
- Works across multiple temperatures and altitudes

Typical properties

- Brands: Versaflo™
- Cartridge or Filter Included: No
- Case Quantity: 1/case
- Clip-on Welding Shield: No
- Compatible Respirator Type: PAPR
- Compatible With: 3M™ Versaflo™ TR-600 Series PAPR
- Enhanced Comfort: No
- Enhanced Durability: No
- Eye Protection: No

3M™ Adflo™ Flow Indicator 15-0099-05, 1 EA/Case

3M Product Number 15-0099-05 3M ID 7000126724 UPC 00051131925892

Details

Flow Indicator
Replacement Part

Typical properties

Brands: Adflo™
Case Quantity: 1
Compatible With: 3M™ Adflo™ PAPR
Features: Respiratory Accessory
Product Series: Adflo
Product Type: Air Flow Indicator
Purpose: Exclude
Recommended Application: Assembly, Facility Maintenance, Grinding, Machine Oper

3M™ Airflow Indicator 520-01-21 1 EA/Case

3M Product Number -504013 3M ID 7000131712 UPC 00051138720568

Details

Used to indicate the airflow rate on 3M™ Breathe Easy™ and Powerflow™ Systems

Typical properties

Brands: 3M™

Case Quantity: 1/pack

Compatible With: 3M™ Airstream™ PAPR, 3M™ Breathe Easy™ PAPR, 3M™ Powerflow™ PAPR

Headgear Type: Full Facepiece

Product Color: Transparent

Product Series: Breathe Easy

Product Type: Air Flow Indicator

3M™ Calibration Kit 529-04-49, 1 EA/Case

Part Number 72012 3M Product Number 529-04-49 3M ID 7100008186

Details

Used to calibrate the carbon monoxide (CO) monitors in the 3M™ Portable Compressed Air Filter and Regulator Panel 256-02-00, 256-02-01 and 3M™ Retrofit CO Monitor Kit W-2808. Contains a 0.6 cubic foot cylinder of zero gas, a 0.6 cubic foot cylinder of span gas, cylinder valve and case

Typical properties

Brands: 3M™
CFM Capacity per Minute: 100 CFM, 50 CFM
Case Quantity: 1/pack
Compatible With: 3M™ Supplied Air Systems
Product Color: Black
Product Series: Supplied Air
Product Type: Calibration Kit
Supplied Air Respirator Style: MST Portable and Fix

3M™ Calibration Kit 529-04-48, Large, 1 EA/Case

Part Number 72787 3M Product Number 529-04-48 3M ID 7000052154

Typical properties

Brands: 3M™

CFM Capacity per Minute: 100 CFM, 50 CFM

Case Quantity: 1/pack

Compatible With: 3M™ Retrofit CO Monitor Kit W-2808

Product Color: Black

Product Series: Supplied Air

Product Type: Calibration Kit

Supplied Air Respirator Style: MST Portab

3M™ Filter Cartridge W-2811-10/07007(AAD), 10 ea/Case

Part Number W281110 3M Product Number W-2811-10 3M ID 7000005377

Details

The filter assembly reduces the amount of particles that may be present in the compressed air system, including water and oil mist
The treated carbon in the filter material helps to lower nuisance level odors

Typical properties

Brands: 3M™
CFM Capacity per Minute: 100 CFM, 50 CFM
Case Quantity: 10/pack
Compatible Respirator: W-2806
Product Color: Gray
Product Series: Supplied Air
Product Type: Filter
Protection Type: Particulate
Recommended Application: Assembly & Mechan

3M™ Coalescing Filter W-3012/07008(AAD) 1 EA/Case

3M Product Number W-3012 3M ID 7000005397 UPC 00051131070080

Details

Used where the concentration of liquid aerosols in compressed air are greater than what can be filtered by the 3M™ Compressed Air Filter and Regulating Panel W-2806 alone

Typical properties

Brands: 3M™

CFM Capacity per Minute: 100 CFM, 50 CFM

Case Quantity: 1/pack

Compatible Respirator: W-2806

Product Color: Gray

Product Series: Supplied Air

Product Type: Filter

Recommended Application: Assembly & Mechanical, Blasting, Cleaning, Metal

3M™ Nose Cup Assembly 7881S, Silicone, 5 EA/Case

3M Product Number 7881S 3M ID 7000001919 UPC 50051138213416

Details

Approved 3M™ replacement part
Recommended for 3M Full Facepiece 7000 Series
Silicone for comfort and durability
Replacement nose cup assembly can extend respiratory equipment service life
Replaceable part can potentially result in respiratory equipment cost savings

Typical properties

Accessories: No
Brands: 3M™
Case Quantity: 1/pack
Clip-on Welding Shield: No
Compatible with 3M™ PAPR Systems: No
Compatible with 3M™ Supplied Air System: No
Compatible with Welding Shield: No
Cool Flow™ Exhalation Valve: No
Drop-down Feature: No

3M™ Band Clamp 7914, 5 EA/Case

3M Product Number 7914 3M ID 7000126016 UPC 50051138214260

Details

Approved 3M replacement part
Designed to secure 3M™ Breathing Room Assembly 7916 to 3M Full Facepiece
7800 Series
Band clamp can extend respiratory equipment service life
Use can potentially result in respiratory equipment cost savings
Band clamp maintains original service performance of facepiece

Typical properties

Accessories: No
Boxes per Case: 5
Brands: 3M™
Case Quantity: 5/case
Clip-on Welding Shield: No
Compatible with 3M™ PAPR Systems: No
Compatible with 3M™ Supplied Air System: No
Compatible with Welding Shield: No
Cool Flow™ Exhalation Valve: No
Dro

3M™ Filter Adapter 603, 16 ea/Case

3M Product Number 603 3M ID 7100066104 UPC 50051141560552

Details

Reusable: can be wiped down between uses

3M™ 603 Filter Adapters has a bayonet attachment

Easy installation

For attaching 5N11 and 5P71 filters and 501 retainers to 3M™ 6000, 7000 and FF-400 series reusable respirator facepieces or 3M™ Scott™ AV-3000 HT and AV-3000 SureSeal facepiece with 3M™ Scott™ AV-632 Bayonet Adapter

Not approved for use with the 3M™ Rugged Comfort Quick Latch Half Facepiece Reusable Respirator 650XQL Series

Typical properties

Accessories: Yes

Brands: 3M™

Case Quantity: 16/case

Compatible Respirator: 6500QL Series

Eye Protection: No

For Use With: 3M™ 6000 Series, 3M™ 6500 Series, 3M™ 7000 Series, 3M™ Ultimate FX FF-400 Series

Maintenance Free: No

Product Color: Gray

Pr

3M™ Cartridge/Filter Adapter 701, 20 EA/Case

Part Number 29113 3M Product Number 701 3M ID 7000126044

Details

Replacement part for 3M™ Full Facepieces 7800S
Bayonet style cartridge connection
20 each per case
For occupational use only

Typical properties

Accessories: Yes
Brands: 3M™
Case Quantity: 10 pairs/case
Clip-on Welding Shield: Yes
Compatible with 3M™ PAPR Systems: Yes
Compatible with 3M™ Supplied Air System: Yes
Compatible with Welding Shield: No
Cool Flow™ Exhalation Valve: No
Drop-down F

3M™ Half Facepiece Respirator Assembly 6291/07002(AAD), Medium, with 3M™ Particulate Filters 2091/07000(AAD), P100 24 EA/Case

Part Number 07002 3M Product Number 6291 3M ID 7000126163

Details

Assembly includes Half Facepiece Respirator and Particulate Filter 2091 P100
Half facepiece design combines comfort and convenience
Remarkably comfortable, soft, lightweight facepiece and easy-to-adjust head straps
Removable filters can be replaced with NIOSH approved 3M filters and cartridges
NIOSH approved for environments containing certain oil and non-oil based particles

Typical properties

Accessories: No
Brands: 3M™
Case Quantity: 24/case
Clip-on Welding Shield: No
Compatible With: Line Compressed Air System SA Series
Compatible with 3M™ PAPR Systems: No
Compatible with 3M™ Supplied Air System: Yes
Compatible with Welding Shield: Ye

3M™ Half Facepiece Respirator Assembly 6391/07003(AAD), Large, with 3M™ Particulate Filters 2091/07000(AAD), P100 24 EA/Case

Part Number 07003 3M Product Number 6391 3M ID 7000126164

Details

Assembly includes Half Facepiece Respirator and Particulate Filter 2091 P100
Half facepiece design combines comfort and convenience
Remarkably comfortable, soft, lightweight facepiece and easy-to-adjust head straps
Removable filters can be replaced with NIOSH approved 3M filters and cartridges
NIOSH approved for environments containing certain oil and non-oil based particles

Typical properties

Accessories: No
Brands: 3M™
Case Quantity: 24/case
Clip-on Welding Shield: No
Compatible With: Line Compressed Air System SA Series
Compatible with 3M™ PAPR Systems: No
Compatible with 3M™ Supplied Air System: Yes
Compatible with Welding Shield: Ye

3M™ Half Facepiece Reusable Respirator Assembly 6191/07001(AAD), P100, Small 24 EA/Case

3M Product Number 6191 3M ID 7010383694 UPC 50051131070016

Details

Assembly includes Half Facepiece Respirator and Particulate Filter 2091 P100
Half facepiece design combines comfort and convenience
Remarkably comfortable, soft, lightweight facepiece and easy-to-adjust head straps
Removable filters can be replaced with NIOSH approved 3M filters and cartridges
NIOSH approved for environments containing certain oil and non-oil based particles

Typical properties

Accessories: No
Brands: 3M™
Case Quantity: 24
Clip-on Welding Shield: No
Compatible with 3M™ PAPR Systems: No
Compatible with 3M™ Supplied Air System: Yes
Compatible with Welding Shield: Yes
Connection Type: Bayonet
Cool Flow™ Exhalation Valve: No

3M™ DBI-SALA® Steel Plate Anchor 2104550, 1 EA

Part Number 2104550 3M Product Number 2104550 3M ID 7100188847

Details

Rugged and corrosion resistant material construction for durability with compact and lightweight design

High strength steel construction

This safety equipment is designed for use with additional personal protective equipment (PPE)

Compatible with various fall arrest systems

Recommended for use in the construction, general industrial, mining, oil and gas, transportation, utilities, and wind energy industries

Allows user to easily work around obstructions

Compact and lightweight design

Set-screw design installs onto 3/8 in. to 1 in. thick (9.5-25.4 mm) plate steel

Integral D-ring tie-off point

Typical properties

Anchor Install Type: Reusable

Attachment Type: Clamp

Brands: DBI-SALA®

Case Quantity: 1

Connected Safety ID Equipped: No

Dimensions: 4.70x3.10x9.00in

Install Type: Reusable

Material: Zinc Plated Steel

Product Color: Yellow Zinc

Product Type: Steel

3M™ DBI-SALA® ExoFit™ NEX™ Safety Harness

Details

Revolving Torso Adapters adjust harness fit with ease and speed and lock webbing into place

Automatic stand-up back D-ring enables efficient dorsal connections

Dual-locking quick connect buckles lock to harness webbing and prevent adjustments from slipping (available on select models)

Lightweight aluminum D-rings

Integrated suspension trauma straps included on all models

Typical properties

Belly Pad: No

Board/Seat Cushion: No

Body Belt: No, Yes

Body Belt Material: Nylon/Neoprene

Brands: DBI-SALA®

Buckle Type: Dual Lock Quick Connect, Pass-through, Quick Connect, Tongue Buckle

Case Quantity: 1

Chest Buckle Material: Zinc Plated Steel

3M™ Welding Face Seals

Details

For use with 3M™ Air Fed welding helmets

Original 3M™ Accessory

Replaces worn or damaged parts

For highest possible safety and comfort, regularly check your equipment for worn or damaged parts

Typical properties

Case Quantity: 1

Compatible Welding Helmet: 9100 Air Series, 9100 FX-Air Welding Helmets, 9100 MP Welding Helmets, G5-01 Welding Helmets

Features: Respiratory Accessory

For Use With: 3M™ Speedglas™ 9100 Air Welding Helmets, 3M™ Speedglas™ 9100FX-Air We

3M™ Facepiece Lens 7884, Replacement Part 5 EA/Case

3M Product Number 7884 3M ID 7000051872 UPC 50051138291148

Details

Approved 3M replacement part
Designed for 3M Full Facepiece 7800 Series (sold separately)
Replacement part can extend service life of facepiece
Replaceable part can potentially result in respiratory equipment cost savings
Lens maintains original service performance of facepiece

Typical properties

Accessories: No
Boxes per Case: 5
Brands: 3M™
Case Quantity: 5/case
Clip-on Welding Shield: No
Compatible Respirator: 7000 Series
Compatible with 3M™ PAPR Systems: Yes
Compatible with 3M™ Supplied Air System: Yes
Eye Protection: Yes
Facepiece Typ

3M™ Speedglas™ Outside Protection Plates

Details

Replacement part

Helps protect the welding filter from welding sparks and spatter

For use with 3M™ Speedglas™ Welding Helmets and Filters

Typical properties

ADF Dark State Shades: Variable 8-12

ADF Shade Range: Variable 8-12

ADF Viewing Area (Metric): 42x93 mm

ADF Viewing Area (hxw): 1.68x3.57in

Case Quantity: 5,50,10

Compatible Welding Helmet: 100 Series, 9000 Series, 9100 Series, G5-02
Welding Helmets,

3M™ DBI-SALA® Fall Protection for Tools Holsters

Details

Compatible with 3M™ DBI-SALA® and Protecta® Harnesses
Various holster options to align with the tools required for the job
Select models incorporate vents, designed to help keep the holster dry

Typical properties

Case Quantity: 1
Connected Safety ID Equipped: No
Dimensions: 5.25 x 2.25 inch
Manufacturing Origin: Taiwan
Net Weight (Metric): 0.09 kg, 0.1 kg, 0.19 kg, 0.2 kg, 0.22 kg, 0.26 kg, 0.29 kg,
0.31 kg, 0.33 kg, 0.41 kg, 0.47 kg, 0.95 kg
Product Color: B

Dimensions and Classifications

Overall Height (Metric): 25.22 mm, 40.64 mm, 41.91 mm, 44.45 mm, 46.99 mm,
54.61 mm, 58.42 mm, 59.69 mm, 62.23 mm, 68.58 mm, 77.47 mm, 92.71 mm,
96.52 mm
Overall Length (Metric): 128.27 mm, 177.8 mm, 189.23 mm, 200.66 mm, 232.41
mm, 234.95 mm, 238.76 mm,

**3M™ Speedglas™ Welding Helmet Magnification Plate 1.5X 06-0500-56, 1
EA/Case**

3M Product Number 06-0500-56 3M ID 7000127143 UPC 00051135893807

Details

Magnification Plate
9100 Series ADFs
Designed for use with Speedglas welding helmets
Installation is easy and secure

Typical properties

Brands: Speedglas™
Case Quantity: 1
Compatible Welding Helmet: 9100 Series
Features: Magnification Plate
Magnification Level: 1.5X
Magnifying Diopter: 1.5
Product Series: 100, 9100, 9100 FX, 9100 QR, 9100-Air, L-Series, SL
Recommended Application:

**3M™ Speedglas™ Welding Helmet Magnification Plate 2.0X 06-0500-57, 1
EA/Case**

3M Product Number 06-0500-57 3M ID 7000127144 UPC 00051135893814

Details

Magnification Plate
9100 Series ADFs
Designed for use with Speedglas welding helmets
Installation is easy and secure

Typical properties

Brands: Speedglas™
Case Quantity: 1
Compatible Welding Helmet: 9100 Series
Features: Magnification Plate
Magnification Level: 2.0X
Magnifying Diopter: 2.0
Product Series: 100, 9100, 9100 FX, 9100 QR, 9100-Air, L-Series, SL
Recommended Application:

**3M™ Speedglas™ Welding Helmet Magnification Plate 2.5X 06-0500-58, 1
EA/Case**

3M Product Number 06-0500-58 3M ID 7000127145 UPC 00051135893821

Details

Magnification Plate
9100 Series ADFs
Designed for use with Speedglas welding helmets
Installation is easy and secure

Typical properties

Brands: Speedglas™
Case Quantity: 1
Compatible Welding Helmet: 9100 Series
Features: Magnification Plate
Magnification Level: 2.5X
Magnifying Diopter: 2.5
Product Series: 100, 9100, 9100 FX, 9100 QR, 9100-Air, L-Series, SL
Recommended Application:

3M™ Speedglas™ Welding Helmet Magnification Plate 3.0X 06-0500-59, 1 EA/Case

3M Product Number 06-0500-59 3M ID 7000127146 UPC 00051135893838

Details

Magnification Plate
9100 Series ADFs
Designed for use with Speedglas welding helmets
Installation is easy and secure

Typical properties

Brands: Speedglas™
Case Quantity: 1
Compatible Welding Helmet: 9100 Series
Features: Magnification Plate
Magnification Level: 3.0X
Magnifying Diopter: 3.0
Product Series: 100, 9100, 9100 FX, 9100 QR, 9100-Air, L-Series, SL
Recommended Application:

3M™ Speedglas™ G5-02 Magnification Plate 08-0500-58, 2.5X

Part Number 08-0500-58 3M Product Number 08-0500-58 3M ID 7100239737

Details

Magnifies objects by 2.5 times the normal power and is designed for use with the 3M™ Speedglas™ Welding Helmet G5-02

No extra lens holder needed, just attach to the G5-02 inner protection plate, making lens installation easier and more secure

Position can be adjusted vertically in five steps for optimized view of your work piece

Installation is easy and secure

Typical properties

Brands: Speedglas™

Case Quantity: 1/Case

Compatible Welding Helmet: G5-02 Welding Helmets

Features: Magnification Plate

For Use With: G5-02 Welding Helmets

Magnification Level: 2.5X

Product Series: G5

Product Type: Magnification Plate

Recommended

3M™ Speedglas™ G5-02 Magnification Plate 08-0500-57, 2.0X

Part Number 08-0500-57 3M Product Number 08-0500-57 3M ID 7100239734

Details

Magnifies objects by 2.0 times the normal power and is designed for use with the 3M™ Speedglas™ Welding Helmet G5-02

No extra lens holder needed, just attach to the G5-02 inner protection plate, making lens installation easier and more secure

Position can be adjusted vertically in five steps for optimized view of your work piece

Installation is easy and secure

Typical properties

Brands: Speedglas™

Case Quantity: 1/Case

Compatible Welding Helmet: G5-02 Welding Helmets

Features: Magnification Plate

For Use With: G5-02 Welding Helmets

Magnification Level: 2.0X

Product Series: G5

Product Type: Magnification Plate

Recommended

3M™ Speedglas™ 9100 QR Earmuff Expander Bar 06-0118-00QR, 1 EA/Case

3M Product Number 06-0118-00QR 3M ID 7100031974 UPC 00051141563701

Details

Earmuff Expander Bar
Accessory Part
9100 QR

Typical properties

Brands: Speedglas™
Case Quantity: 1
Compatible Welding Helmet: 9100 QR Welding Helmets
Product Color: Black
Product Series: 9100, 9100 QR
Recommended Application: Assembly, Facility Maintenance, Grinding, Machine Operation, Sanding, Welding
Recommen

3M™ Speedglas™ FA III SAR V-100 and Speedglas™ Welding Helmet 9100 FX-Air, 26-5702-30iSW, ADF 9100XXi 1 EA/CS

3M ID 7100194538 UPC 00051131277816

Details

3M™ Speedglas™ Welding Helmet 9100 FX-Air with customizable head suspension
Belt-mounted V-100 air-cooling valve lowers temperature by up to 50°F (28°C)
APF of 25 helps reduce exposure to particles and vapors
Side windows allow for better peripheral vision
Airflow control: 170 lpm to 424 lpm
Requires grade D breathable air source
Applications include assembly, mechanical, facility maintenance, grinding, machine operations, metal repair, sanding, and welding
Meets requirements of ANSI Z87.1-2010 and NIOSH

Typical properties

ADF Model: 9100XXi
ADF Shade Range: Variable 5, 8-13
ADF Viewing Area (hwxw): 2.8x4.2in
Air Source: SAR
Battery Life: ADF: up to 1800 Hours
Battery Type: ADF: CR2032
Brands: Speedglas™
Comes with Auto-Darkening Filter (ADF): Yes
Dark Shades: Shade

3M™ 332 Impact Safety Goggles 40650-00000-10, Clear Lens, 10 EA/Case

3M Product Number 40650-00000-10 3M ID 7010340634 UPC 10078371621374

Details

Economical goggle
Direct venting system that circulates air and helps minimize fogging
Over-the-glass coverage
Clear lens

Typical properties

Anti Fog Lens: No
Brands: 3M™
Case Quantity: 10
Class: Economy
Comfort Features: Adjustable elastic strap, Direct Ventilation, Fits over most glasses
Eyewear Range: Economy
Frame Color: Clear
Frame Style: Goggle
Hard Coat Lens: No
Lens Coating: U

3M™ Speedglas™ 9000 Series Welding Helmets

Details

Exclusive exhalation venting

Comfortable and lightweight

3M™ Speedglas™ 9002NC Auto-Darkening Lens provides a large viewing area, natural color and customizable settings for multiple welding applications

Fast switching

Excellent optics

Helmet weight (without lens): 325 g

Optional Hard Hat Adapter is specially designed for welders working in areas with overhead hazards

Typical properties

ADF Model: 9002NC, None

ADF Viewing Area (Metric): 54 mm x 107 mm

Battery Life: 2000 hours

Battery Type: ADF: CR2032

Case Quantity: 1

Comes with Auto-Darkening Filter (ADF): No, Yes

Features: Traditional Headgear

Front Panel Included: Yes

Headband

Dimensions and Classifications

ADF Viewing Area (Imperial): 2.1 in x 4.2 in

3M™ Protecta® Belt

Details

Body belts available in designs to be used independently, as well as other versions to be used with 3M Fall Protection Harnesses

Multiple sizes available

Meets applicable regulatory standards

Typical properties

Belly Pad: No

Belt Type: Waist

Board/Seat Cushion: No

Brands: PROTECTA®

Buckle Material: Stainless Steel Grommet, Zinc Plated Steel

Buckle Type: Tongue Buckle

Case Quantity: 1

Connected Safety ID Equipped: No

D-ring Material: Stamped steel, Zinc P

3M™ DBI-SALA® FlexiGuard™ Counterweighted System

Details

Counterweighted overhead rail fall protection system
Aluminum and steel construction
Complete hardware provided
Portable with use of a forklift
Includes four steel leveling jacks; built-in slope indicators available as option
Recommended for a variety of applications within the transportation, construction, utilities, and mining industries
Available in multiple sizes, both fixed and adjustable heights
One part of your fall protection system; intended for use with other personal protective equipment (PPE) including (but not limited to) harnesses and self-retracting lifelines
Specialized installation and training available
Heavy duty leveling jacks and built-in slope indicators
Custom paint finishes available
Accessories available to suit worksite needs

Typical properties

Case Quantity: 1,1 EA/Case
Connected Safety ID Equipped: Yes
Dimensions: (12.00x8.00x9.30)in
Install Type: Temporary/Portable
Maximum Number of Users: Two
Net Weight (Imperial): 3850 lb
Product Color: Silver, Yellow
Product Series: FlexiGuard™
Pro

3M™ DBI-SALA® Rollgliss™ Descender, Vertical/Auto Retract

Details

28.6 kg emergency rescue and evacuation descender for use at any level
Fully automatic controlled vertical descent
Automatic retraction allows for multiple rescues and evacuations
Cable lifeline available in galvanized steel or stainless steel
3/16 in. (5 mm) diameter lifeline available in lengths of 115 ft. (35 m) or 200 ft. (61 m)
Pre-rigged design makes descender easy and simple use
Extra-durable, corrosion-resistant construction
Recommended for use in mining, oil and gas, and general industrial applications

Typical properties

Case Quantity: 1,1 EA/Case
CoWorker Controlled Ascent: No
CoWorker Controlled Descent: No
Connected Safety ID Equipped: Yes
Descent Type: Vertical
Lifeline Material: Galvanized Wire Rope, Stainless Steel Wire Rope
Line Length (Imperial): 115 ft, 200

Dimensions and Classifications

Overall Length (Imperial): 115 ft, 200 ft
Overall Length (Metric): 35 m, 61 m

3M™ DBI-SALA® ExoFit™ XP Safety Harness

Details

Automatic stand-up back D-ring enables efficient dorsal connections
Removable shoulder, back and leg comfort padding
Protected labels, equipped with an integrated RFID tag, enabling inventory, inspection, and record management

Typical properties

Body Belt: No, Yes
Brands: DBI-SALA®
Buckle Type: Pass-through, Quick Connect
Case Quantity: 1
Chest Buckle Material: PVC Coated Steel, Zinc Plated Steel
Connected Safety ID Equipped: Yes
D-ring Material: Zinc Plated Steel
D-ring Placement: Back, F

3M™ Scotchlite™ Reflective Material 8932 Series

Details

3M™ Scotchlite™ Reflective Material is designed for enhancing visibility in low light and nighttime conditions
Certified to various global high visibility standards such as ANSI/ISEA 107
Certified to various flame resistant standards such as NFPA
Sew-on application

Typical properties

Adhesive: None
Attachment Type: Sew On
Backing Material: Flame Retardant Cotton
Brands: Scotchlite™
Certified Performance Required: ANSI 107-2015, CSA Z95-2015
Daytime Color: Silver
Dry-Cleaning Cycles at ANSI Certified Standards: 15
Dry-Cleaning C

Dimensions and Classifications

Overall Length (Imperial): 54.68 yd, 218.72 yd
Overall Length (Metric): 50 m, 200 m
Overall Width (Imperial): 0.75 in, 1 in, 1.18 in, 2 in, 2.75 in, 3 in, 36 in
Overall Width (Metric): 19.05 mm, 25.4 mm, 30 mm, 50.8 mm, 70 mm, 914.4 mm

3M™ PELTOR™ ORA TAC Big Button Connector, CON-SDBB, 1 each/case

3M Product Number CON-SDBB 3M ID 7000128208 UPC 00093045936915

Details

A large Push-To-Talk button for the 3M™ PELTOR™ ORA TAC In-Ear Headset
Useful for when gloved hands or garments prevent activation of the PTT on the ORA TAC handset

Move and clip the Big PTT Button to a convenience location on your body
4.5" curly cable (15" total unextended length)

Typical properties

Brands: PELTOR™

Intrinsically Safe: No

Plug Type: 4-pin XLR

Product Color: Black

Product Type: Connector

Purpose: Exclude

Recommended Application: Assembly, Blasting, Cleaning, Demolition, Electrical, Facility Maintenance, Grinding, Health & Safety

3M™ DBI-SALA® Delta™ Safety Harness

Details

Automatic stand-up back D-ring enables efficient dorsal connections
Revolving torso adjuster buckles available on select models
Available in multiple styles, configurations, and leg and chest connection options
Integrated suspension trauma straps included on most models
Equipped with auto-resetting lanyard keepers for fast and easy parking of snap hooks and carabiners
Protected labels, equipped with an integrated RFID tag, enabling inventory, inspection, and record management

Typical properties

Board/Seat Material: Stainless Steel Grommet
Body Belt: No, Yes
Brands: DBI-SALA®
Buckle Type: Parachute, Pass-through, Quick Connect, Revolver™, Tech-Lite™
Quick Connect, Tongue Buckle
Case Quantity: 1
Chest Buckle Material: PVC Coated Steel, Zinc P

3M™ Protective Coverall 4535

3M ID B00046827

Details

Two-way zipper with sealable storm flap helps provide additional protection against contaminants

Anti-static treatment can help reduce static build-up

Knit cuffs provide a soft wrist closure for increased comfort

Anatomical design for optimal, wear, coverage, and comfort

Recommended for use in multiple industries including agriculture (particulate aerosols only), industrial cleaning and maintenance, chemical processing, asbestos inspection, insulation laying, pesticide handling, pharmaceutical manufacturing, paint spraying, and more

20 units included in each case

Typical properties

eClass 14 Classification Group: 46090409

3M™ Disposable Protective Overboot Cover 440, Universal Size, 100 Pairs EA/Case

3M Product Number 440 3M ID 7000089719 UPC 04046719402861

Details

Provides footwear protection for workers and helps reduce workplace contamination

Constructed from microporous PE laminate material

Universal size with elastic at the top and ties help provide a good fit

100 pairs included in each case

Typical properties

Brands: 3M™

Features: Anti-static, With Ties

Hazard Type: Dust, Light Liquid splash, Non Hazardous liquids & dust (CE simple), Particulate

Material: Laminate

Product Color: White

Product Series: 440, Food Industry

Product Type: Overboot

Recommended

3M™ GoggleGear™ 500 Series GG500-PI, Prescription Insert

Details

Prescription lens insert available for 3M™ Goggle Gear, 500-Series Splash Goggles

3M™ Scotchgard™ Anti-Fog Coating lasts longer* than traditional anti-fog coatings , helping to increase eyewear performance in wet and steamy environments

Workers may enjoy reliable, clearer sight longer, because the coating with its active ingredient is bonded to the lens

The coating retains its effectiveness for at least 25 washings with water, allowing workers to wear their eyewear longer

The coating withstands disinfection with diluted bleach soaking or alcohol wipes without losing its anti-fog performance

3M™ Scotchgard™ Anti-Fog Coated Eyewear meets the requirements of ANSI Z87.1-2015 and

*Based on 3M internal testing per EN168 test method when compared to traditional anti-fog coatings

Typical properties

3M Technology: Scotchgard Anti-Fog Coating

Anti Fog Lens: Yes

Brands: 3M™

Case Quantity: 10

Comfort Features: Clip-on system

Eyewear Range: Premium

For Use With: 3M™ Solus™ 1000 Series Protective Eyewear

Frame Color: Clear

Frame Material: Plastic

Dimensions and Classifications

Overall Height (Metric): 15.24 cm

3M™ Pro-Comms Electronic Hearing Protector

3M ID 70009127435 UPC 00638060922392

Details

EXTERNAL MICROPHONES for situational awareness
NOISE-CANCELING BOOM MICROPHONE for communication in high-noise environments
QUICK AND EASY COMMUNICATION among team members and groups helps increase productivity
PUSH-TO-TALK FEATURE WITH THIRD-PARTY APP for headset-to-headset and group communication
BLUETOOTH® WIRELESS TECHNOLOGY for calls and music
NOISE REDUCTION RATING (NRR) OF 26 dB (25 dB with hard hat)
DURABLE RECESSED MICROPHONES help prevent damage and reduce wind noise
IDEAL FOR TEAMS OR GROUPS of workers who need to communicate on the job site while helping protect their hearing
ERGONOMICALLY DESIGNED CONTROLS with Audio Assist for easy set-up and guidance
PREMIUM GEL CUSHIONS are super-soft and conformable for enhanced comfort
HARD-HAT COMPATIBLE with the 3M™ Hard Hat Adaptor (sold separately — Part #P3EG-PK)
CANTED EAR CUPS for a more comfortable fit
ADJUSTABLE VENTED HEADBAND
RECOMMENDED FOR home construction, road construction, lawn crews and more
2-HOUR AUTO SHUT-OFF

Typical properties

Battery Type: Disposable AA
Brands: 3M™
Catalog Number: 90546-SIOC
Factory ISO Certification: No ISO Certification information available
eClass 14 Classification Group: 40270191

3M™ Pro-Protect Electronic Hearing Protector + Gel Cushions

3M ID 70009127443 UPC 00638060922408

Details

ACTIVE MICROPHONES for communication and awareness
BLUETOOTH® WIRELESS TECHNOLOGY for calls and music
NOISE REDUCTION RATING (NRR) OF 26 dB (26 dB with hard hat)
60+ HOUR BATTERY LIFE with 4-hour auto shut-off
DURABLE RECESSED MICROPHONES help prevent damage and reduce wind noise
IDEAL FOR TEAMS OR GROUPS of workers who need to communicate on the job site while helping protect their hearing
ERGONOMICALLY DESIGNED CONTROLS for easy use, even with gloves
AUDIO ASSIST TECHNOLOGY for easy set-up and guidance
PREMIUM GEL CUSHIONS are super-soft and conformable for enhanced comfort
CANTED EAR CUPS for a more comfortable fit
HARD-HAT COMPATIBLE with the 3M™ Hard Hat Adaptor (sold separately — Part #P3EG-PK)
ADJUSTABLE VENTED HEADBAND
RECOMMENDED FOR home construction, road construction, lawn crews and more
RUNS ON 2 AA BATTERIES (not included)

Typical properties

Battery Type: Disposable AA
Brands: 3M™
Catalog Number: 90545-SIOC
Factory ISO Certification: No ISO Certification information available
eClass 14 Classification Group: 40270191

3M™ Pro-Protect Electronic Hearing Protector

3M ID 70009127427 UPC 00638060922385

Details

ACTIVE MICROPHONES for communication and awareness
BLUETOOTH® WIRELESS TECHNOLOGY for calls and music
NOISE REDUCTION RATING (NRR) OF 25 dB (25 dB with hard hat)
60+ HOUR BATTERY LIFE with 4-hour auto shut-off
DURABLE RECESSED MICROPHONES help prevent damage and reduce wind noise
IDEAL FOR TEAMS OR GROUPS of workers who need to communicate on the job site while helping protect their hearing
ERGONOMICALLY DESIGNED CONTROLS for easy use, even with gloves
AUDIO ASSIST TECHNOLOGY for easy set-up and guidance
CANTED EAR CUPS with soft, conformable ear cushions for comfortable extended wear
ADJUSTABLE VENTED HEADBAND
HARD-HAT COMPATIBLE with the 3M™ Hard Hat Adaptor (sold separately — Part #P3EG-PK)
RECOMMENDED FOR home construction, road construction, lawn crews and more
RUNS ON 2 AA BATTERIES (not included)

Typical properties

Audio Type: Music/Entertainment
Brands: 3M™
Catalog Number: 90545H1-DC-PS
Factory ISO Certification: No ISO Certification information available
Suspension Method: Headband
eClass 14 Classification Group: 40270191

3M™ Protective Coverall 4515

3M ID B00046820

Details

Two-way zipper with sealable storm flap helps provide additional protection against contaminants

Does not contain natural rubber latex components

Extra-roomy design in arms and legs deliver enhanced mobility

Recommended for use in multiple industries including general manufacturing, mining, and more

Available in blue coveralls and white coveralls

20 units included in each case

Typical properties

eClass 14 Classification Group: 46090409

3M™ Disposable Lab Coat

Details

Recommended for use in multiple industries including general maintenance, electronics manufacturing, catering, clean rooms, beauty industries, hygiene, laboratories, and more

Available in a wide range of sizes

50 units included in each case

Typical properties

Brands: 3M™

Closure Method: Simple Zipper

Features: Anti-static, Antistatic Protection, Collared (for labcoats), Knitted Cuff

Hazard Type: Non Hazardous, Non Hazardous liquids & dust (CE simple)

Material: Laminate

Product Color: White

Product Series

3M™ Disposable Protective Oversleeve 444, Universal Size, 150 pairs/Case

3M ID 7000089717 UPC 04046719402823

Details

Construction from microporous PE laminate material
Top and bottom elastic provide a secure fit for a range of arm sizes
Recommended for use in multiple industries including general maintenance, electronics manufacturing, catering, clean rooms, beauty industries, hygiene, laboratories, and more
150 pairs included in each case

Typical properties

Brands: 3M™
Features: Anti-static, Elastic Cuff
Hazard Type: Non Hazardous liquids & dust (CE simple)
Material: Laminate
Product Color: White
Product Series: Food Industry
Product Type: Oversleeve
Recommended Application: Catering, Clean Rooms, Ele

3M™ E-A-R™ Caboflex™ Model 600 Hearing Protector 320-2001, 100 Pair/Case

3M Product Number 320-2001 3M ID 7000002297 UPC 10080529200003

Details

Silicone tips contain a foam core for an effective seal and good noise reduction

Flexible band can be worn under the chin for use with hard hats

Ideal for intermittent hearing protection needs

Replacement Pods also available

Noise Reduction Rating (NRR)* 20 dB when the band is worn under-the-chin. 17 dB when the band is worn behind-the-head. CSA Class BL

Typical properties

Banded: Yes

Brands: E-A-R™

Case Quantity: 100

Corded: No

Dielectric: No

Earplug Material: Foam/Thermoplastic

Earplug Shape: Cone

Earplug Size: Regular

Electrically Insulated: Yes

Hearing Protection Style: Banded

Insertion Style: No Roll

Material

3M™ Scott™ ACSi SCBA

3M ID B5005047160

Details

Lightweight, flexible Thermoflex backplate and adjustable padded shoulder and waistband straps for greater comfort and ease of donning and doffing
Pneumatics are easily removed with a 3M Scott "quarter-turn" – no tools required – for ease of maintenance, cleaning and turn-around
The E-Z Flo regulator is designed for gloved hands, enables easy breathing, and has a two step secure attachment to help ensure worker confidence
Shoulder mounted photoluminescent gauge with whistle end-of-service alarm for ease of use
NIOSH approved for use with 3M Scott AV series facepieces that can also be used for APR, PAPR, supplied air, and SCBA applications
Available in 2216 or 4500 psi variants and 30, 45 or 60 minute durations
Optional extended duration airline for added respirator versatility

Typical properties

Brands: Scott™
Harness Material: Polyester
Included Regulator: E-Z Flo
Product Type: Self-contained Breathing Apparatus

3M™ DBI-SALA® 3-Piece Portable Davit Base

Details

- 3-piece portable davit base
- Unique foot level and height adjustment system
- Built-in level indicator
- PVC davit mast sleeve liner
- Set-up and dismantle without tools
- Lightweight, durable aluminum construction
- Set-up and dismantle without tools
- Lightweight, corrosion resistant aluminum construction

Typical properties

- Case Quantity: 1
- Connected Safety ID Equipped: No
- Install Type: Portable
- Net Weight (Imperial): 59.5 lb, 119 lb
- Net Weight (Metric): 27 kg, 54 kg
- Product Color: Green, Silver
- Product Series: Advanced™
- Product Type: 3-Piece Portable Davit Base
- Reco

3M™ Protecta® Rope Lifeline with Swivel Snap Hook 1299997, 5/8 in Polyester and Polypropylene Blend, White, 50 ft

Part Number 1299997 3M Product Number 1299997 3M ID 7012817332

Details

Provides freedom of movement operation
Detachable
Brake locks rope grab onto lifeline in case of a fall

Typical properties

Anchor Connection Type: Snap Hook
Attachment Type: None
Brands: PROTECTA®
Case Quantity: 1
Connected Safety ID Equipped: No
Install Type: Temporary
Maximum Number of Users: One
Product Series: PRO™
Product Type: Rope Lifeline with Snap Hook
Recom

Dimensions and Classifications

Overall Length (Imperial): 50 ft

3M™ PROTECTA® PRO™ Rope Lifeline with Snap Hook 1299998, 1 EA

Part Number 1299998 3M Product Number 1299998 3M ID 7100218794

Details

Provides freedom of movement operation
Detachable
Brake locks rope grab onto lifeline in case of a fall

Typical properties

Anchor Connection Type: Snap Hook
Attachment Type: None
Brands: PROTECTA®
Case Quantity: 1
Connected Safety ID Equipped: No
Connector Material: Swiveling Snap Hook
Install Type: Temporary
Lifeline Length (Imperial): 100 ft
Lifeline Length (Metric)

Dimensions and Classifications

Overall Length (Imperial): 100 ft

3M™ Protecta® Rope Lifeline with Snap Hook Both Ends AC215A2, 5/8 in Nylon, White, 50 ft

3M ID 7012822259 UPC 00648250031001

Details

- Provides freedom of movement operation
- Detachable
- Brake locks rope grab onto lifeline in case of a fall

Typical properties

- Lifeline Length (Imperial): 50 ft
- Lifeline Length (Metric): 15.2 m
- Lifeline Material: Nylon Core/Polyester Cover

3M™ PELTOR™ Foam Windscreen for TEP-100, TEP-WINDSCREEN

3M Product Number TEP-WINDSCREEN 3M ID 7100113748 UPC 10093045938114

Details

Provides protection from wind noise
Easily Replacable
Easy to apply
15 pairs per package for reapplication

Typical properties

Brands: PELTOR™
Case Quantity: 15
Product Color: Gray
Product Type: Wind Screen
Recommended Application: Agriculture
Tactical Communication Protection System (TCAPS): Yes
eClass 14 Classification Group: 40270191

3M™ PELTOR™ Boom Microphone, MT73/1, 1 EA/CS

3M Product Number MT73/1 3M ID 7100112094 UPC 07318640067547

Details

Dynamic noise-cancelling boom microphone
Water and Dust Resistant (IP68)
Improved communications in windy environments
Easy to clean

Typical properties

Brands: PELTOR™
External Audio Input: No
Product Type: Microphone
eClass 14 Classification Group: 40270191

3M™ Peltor™ Wind Protector, M171/2, 200 pair/Case

3M Product Number M171/2 3M ID 7100112112

Details

Fits easily over most boom microphone heads
Improves speech clarity by reducing wind noise
For use on different 3M™ PELTOR™ Microphones
3M™ PELTOR™ spare part

Typical properties

Brands: PELTOR™
Case Quantity: 200 pair/Case
External Audio Input: No
Product Type: Wind Screen
eClass 14 Classification Group: 40270191

3M™ PELTOR™ Boom Microphone Wind Screen, M995, 1 EA/CS

3M Product Number M995 3M ID 7000127274 UPC 00093045978786

Details

Foam windscreen for the 3M™ PELTOR™ Electret Boom Microphone
Helps reduce transmission interference due to wind noise
For use in windy environments

Typical properties

Brands: PELTOR™
Product Color: Black
Product Type: Wind Screen
Purpose: Exclude
eClass 14 Classification Group: 40270191

M40/1 WIND SHIELD FOR DYNAMIC MICROPHONE SMALL 1/CASE

3M Product Number M40/1 3M ID 7000039648 UPC 07318640011700

Details

Foam windscreen for the 3M™ PELTOR™ Dynamic Boom Microphone
Helps reduce transmission interference due to wind noise
For use in windy environments
EA/Case

Typical properties

Brands: PELTOR™
Case Quantity: 200
Product Color: Black
Product Type: Microphone
Purpose: Exclude
Recommended Application: Assembly, Demolition, Electrical, Machine Operation,
Remediation
eClass 14 Classification Group: 40270191

3M™ PELTOR™ Cup Mic Windsock M60/2 1 EA/Case

3M Product Number M60/2 3M ID 7000039650 UPC 04054596815636

Details

Foam windscreens for environmental microphones
Helps to reduce wind noise and protect the environmental microphones
For use on a wide variety of 3M™ PELTOR™ Communication Headsets
1 pair

Typical properties

Brands: PELTOR™
Product Color: Black
Product Type: Wind Screen
Purpose: Exclude
eClass 14 Classification Group: 40270191

3M™ PELTOR™ UltraFit™ Replacement Tips 420-2096-25A, Gray, 25 pr/cs

3M Product Number 420-2096-25A 3M ID 7000128143 UPC 10093045935311

Details

For use with select in-ear 3M™ PELTOR™ Advanced Hearing Protectors
Offers triple-flanged design for comfortable fit
Helps provide protection while enabling the user to hear in noisy environments

Typical properties

Brands: PELTOR™
Product Type: Eartip
Purpose: Exclude
Recommended Application: Assembly, Blasting, Cleaning, Demolition, Electrical, Facility Maintenance, Grinding, Health & Safety Testing, Machine Operation, Painting, Remediation, Sanding, Welding
Re

3M™ PELTOR™ UltraFit Communication Tip Replacement, Medium, 25 EA/Case

3M Product Number 370-TEPM-25 3M ID 7100066387 UPC 10093045937810

Details

Tri Flange Eartips, Medium

25 EA/Case

Helps provide protection while enabling the user to hear in noisy environments

Desert tan color

Typical properties

Brands: PELTOR™

Case Quantity: 25

Product Color: Tan

Product Type: Eartip

Recommended Application: Law Enforcement, Military, Tactical

Recommended Industry: Hunting, Law Enforcement, Military Maintenance,
Repair & Operation (MRO), Military Tactical,

3M™ PELTOR™ UltraFit Communication Tip Replacement, Small, 25 EA/Carton

3M Product Number 370-TEPS-25 3M ID 7100066371 UPC 10093045937803

Details

Tri Flange Eartips, Small

25 EA/Carton

Helps provide protection while enabling the user to hear in noisy environments

OD green color

Typical properties

Brands: PELTOR™

Case Quantity: 25

Product Color: Brown

Product Type: Eartip

Recommended Application: Law Enforcement, Military, Tactical

Recommended Industry: Hunting, Law Enforcement, Military Maintenance,

Repair & Operation (MRO), Military Tactical

3M™ PELTOR™ UltraFit Communication Tip Replacement, Large, 25 EA/Case

3M Product Number 370-TEPL-25 3M ID 7100066388 UPC 10093045937827

Details

Tri Flange Eartips, Large

25 EA/Case

Helps provide protection while enabling the user to hear in noisy environments

Coyote brown color

Typical properties

Brands: PELTOR™

Case Quantity: 25

Product Color: Brown

Product Type: Eartip

Recommended Application: Law Enforcement, Military, Tactical

Recommended Industry: Hunting, Law Enforcement, Military Maintenance, Repair & Operation (MRO), Military Tactical

3M™ 62093 Performance Respirator Mold & Lead Paint Removal

3M ID 70006983350 UPC 00051141905204

Details

NIOSH-APPROVED P100 RATED filters for at least 99.97% filtration efficiency against solids and liquid aerosols, as well as oils

FOR WORKPLACE/OCCUPATIONAL USE ONLY

ADJUSTABLE HEAD STRAPS allow for personalized fit

Package Contents: one facepiece, one pair replaceable #7093 P100 filters

3M™ BAYONET CONNECTION compatible with 3M™ cartridges and filters

OIL RESISTANT P-series particulate filter

CONVENIENT, REUSABLE DESIGN

3M™ BAYONET CONNECTION compatible with 3M™ cartridges and filters

Package Contents: one facepiece, one pair replaceable #7093 P100 filters

Intended for the professional removal of lead-based paints, woodworking and working with fiberglass insulation

Use this product is in accordance with all OSHA respiratory protection requirements including OSHA Lead Standard

Contains no components made from natural rubber latex

WARNING: Workplace/Occupational Applications: This respirator helps protect against certain airborne contaminants. Misuse may result in sickness or death.

For correct use, consult supervisor and User Instructions, or call 3M in USA at 1-800-243-4630. In Canada, call 1-800-267-4414

Typical properties

Application Type: Mould & Lead Paint Removal

Brands: 3M™

Cartridge or Filter Included: Yes

Cartridge or Filter Type: Combination

Catalog Number: 62093H1-DC

Clip-on Welding Shield: No

Compatible with 3M™ PAPR Systems: No

Compatible with 3M™ Supplied

Dimensions and Classifications

Overall Height (Imperial): 8.9 in

Overall Height (Metric): 22.606 cm

Overall Length (Imperial): 6 in

Overall Length (Metric): 12.954 cm

Overall Width (Imperial): 7.5 in

Overall Width (Metric): 23.622 cm

3M™ SecureFit™ 200 Eyewear Anti-Fog, SF200P1-DC, Clear, Clear Lens, 6/case

3M ID 70006988003 UPC 00051141388830

Details

Durable lenses help provide limited protection from light to moderate impact hazards
3M™ Pressure Diffusion Temple Technology self adjusts to provide a secure, comfortable fit
Lightweight, durable design for comfort and lasting wear
Weighs less than 1 ounce
Sleek temples create a comfortable fit when worn with ear protection
When worn with hearing protection, flat temple design limits risk of reduced effectiveness
Flexible temples conform comfortably to different head sizes
Compatible with many types of additional Personal Protection Equipment (PPE)
Anti fog, scratch resistant lenses help keep vision clear
Impact resistant lenses block 99.9% of UV rays
Meets the requirements of ANSI Z87.1, CSA Z94.3 and AS/NZS 1337
Clear lenses help provide excellent visibility and can be used indoors or outdoors

Typical properties

Brands: SecureFit™
Catalog Number: SF200P1-DC
Factory ISO Certification: No ISO Certification information available
Frame Material: Polycarbonate
Frame Style: Wraparound
Material: Polycarbonate
Sealed Eyewear: No
Splash Protection: No
Standards an

Dimensions and Classifications

Overall Height (Imperial): 5 in
Overall Height (Metric): 127 mm
Overall Length (Imperial): 2.5 in
Overall Length (Metric): 63.5 mm
Overall Width (Imperial): 9.8 in
Overall Width (Metric): 248.92 mm

3M™ SecureFit™ 200 Eyewear Anti-Fog, Clear, Clear Lens

3M ID 70006987997 UPC 00051141388854

Details

Sleek temple design limits risk of reduced effectiveness of hearing protection
3M™ Pressure Diffusion Temple Technology self-adjusts to provide a secure, comfortable fit
Lightweight, durable design for comfort and lasting wear
Weighs less than 1 ounce
Great for use with additional Personal Protection Equipment (PPE)
Impact-resistant lenses block 99.9% of UV rays
Meets the requirements of ANSI Z87.1 , CSA Z94.3 and AS/NZS 1337
Clear lenses help provide excellent visibility and can be used indoors or outdoors

Typical properties

Brands: 3M™
Catalog Number: SF200H1-DC
Factory ISO Certification: No ISO Certification information available
Frame Material: Polycarbonate
Frame Style: Wraparound
Material: Polycarbonate
Sealed Eyewear: No
Splash Protection: No
Standards and Speci

Dimensions and Classifications

Overall Height (Imperial): 5 in
Overall Height (Metric): 127 mm
Overall Length (Imperial): 2.5 in
Overall Length (Metric): 63.5 mm
Overall Width (Imperial): 9.8 in
Overall Width (Metric): 248.92 mm

**3M™ SecureFit™ 200 Eyewear Anti-Fog, SF200G1-DC, Clear, Clear
Lens,
4/case**

3M ID 70006987922 UPC 00076308726423

Typical properties

Brands: 3M™

Factory ISO Certification: No ISO Certification information available

eClass 14 Classification Group: 40230101

3M™ SecureFit™ 201 Eyewear Anti-Fog, SF201G1-DC, Gray, Gray Lens, 4/case

3M ID 70006987914 UPC 00076308726447

Details

Sleek temple design limits risk of reduced effectiveness of hearing protection
3M™ Pressure Diffusion Temple Technology self-adjusts to provide a secure, comfortable fit

Lightweight, durable design for comfort and lasting wear

Weighs less than 1 ounce

Great for use with additional Personal Protection Equipment (PPE)

Impact-resistant lenses block 99.9% of UV rays

Meets the requirements of ANSI Z87.1 , CSA Z94.3 and AS/NZS 1337

Gray lenses help reduce sunlight and are ideal for outdoor use

Typical properties

Brands: SecureFit™

Factory ISO Certification: No ISO Certification information available

Frame Material: Polycarbonate

Frame Style: Wraparound

Sealed Eyewear: No

Splash Protection: No

Temple Style: 3M Pressure Diffusion Temple Technology, SecureFit™

Dimensions and Classifications

Overall Height (Imperial): 5 in

Overall Height (Metric): 127 mm

Overall Length (Imperial): 2.5 in

Overall Length (Metric): 63.5 mm

Overall Width (Imperial): 9.8 in

Overall Width (Metric): 248.92 mm

3M™ SecureFit™ X5000 Series Safety Helmets

Details

Suspension system incorporates exclusive patented 3M™ Pressure Diffusion Technology

Works with a variety of 3M™ Faceshields, Earmuffs, and other accessories

Meets ANSI Z89.1

Climbing helmet-inspired design

Customizable fit with multiple levels of vertical adjustment

Features 4-point chin strap with buckle and selector

3M's unique 4-point chin strap selector system makes it possible to switch between EN 12492 (Mountaineering helmets) and EN 397 (Industrial safety helmets) standards

Typical properties

Brands: SecureFit™

Case Quantity: 4,10

Features: Accessory Slots, Pressure Diffusion Technology, Replaceable Brow Pad, UV Indicator

For Use With: Earmuffs, Faceshields, Headlamps, Reflective Markings

Hard Hat Type: Type I

Product Color: Black, Blue,

3M™ Speedglas™ Welding Lens Assembly 9100, 06-0000-P10, Passive Shade 10, 1/Case

3M Product Number 06-0000-P10 3M ID 7010342411 UPC 00051141563176

Details

Passive welding filters can work well for welders who perform long continuous welds rather than tack welds or for use in wet environments

Full Passive Lens Assembly

Excellent lower-cost lens option for large, 2.8 x 4.2 in. (approx.) viewing area

Typical properties

ADF Viewing Area (hwxw): 2.8x4.2in

Brands: Speedglas™

Compatible Welding Helmet: 9100 Series

For Use With: 3M™ Speedglas™ 9100 Air Welding Helmets, 3M™ Speedglas™ 9100 Welding Helmets, 3M™ Speedglas™ 9100FX Welding Helmets, 3M™ Speedglas™ 9100FX-Air Wel

3M™ Speedglas™ G5 Series Auto Darkening Welding Filters

Details

Robust, reliable function

Compatible with both G5-01 and G5-03 helmets

Bluetooth enabled. Utilizing the 3M Connected Equipment app, users get access to additional functionalities, statistics and documentation

By selecting just the right welding filter settings for each task, you help reduce eye strain and may help improve the quality of the weld

Typical properties

ADF Model: G5-01/03TW, G5-01/03VC, G5TW, G5VC

ADF Technology: Natural Color, TAP, Tack Weld Mode, Variable Color

Auto On: Yes

Battery Life: ADF up to 1500 hours

Battery Type: ADF: Lithium 3V (CR2450), Lithium 3V (CR2450)

Brands: Speedglas™

Case Quan

3M™ Solus™ Replacement Strap, 10 ea/Bag

3M Product Number Solus-Strap 3M ID 7100085458

Details

Elastic strap helps keep eyewear securely in place
Replacement part for use with 3M™ Solus™ 1000 Series Safety Eyewear
Removable feature allows strap to be detached
Meets the requirements of ANSI Z87.1-2015

Typical properties

Brands: Solus™
For Use With: 3M™ Solus™ 1000 Series Safety Glasses
Product Type: Replacement Strap
Recommended Application: Assembly, Cleaning, Demolition, Drilling, Facility Maintenance, Grinding, Machining, Masonry, Remediation, Sanding, Sawing
Rec

Dimensions and Classifications

Overall Height (Imperial): 3.25 in
Overall Height (Metric): 8.26 cm
Overall Length (Imperial): 6.87 in
Overall Length (Metric): 17.46 cm
Overall Width (Imperial): 5.87 in
Overall Width (Metric): 14.92 cm

3M™ DBI-SALA® Web D-ring Extension Anchor 1231277, Polyester, 1.4 ft

Part Number 1231277 3M Product Number 1231277 3M ID 7012817040

Details

- Extends dorsal harness D-ring (or overhead anchor point)
- High strength D-ring tie-off point
- Constructed with abrasion resistant materials
- Built-in wear indicator

Typical properties

- Anchor Hook Material: Zinc Plated Steel
- Brands: DBI-SALA®
- Case Quantity: 1
- Connected Safety ID Equipped: Yes
- Harness Connection Hook Material: Aluminum and Zinc Plated Steel
- Lanyard Material: Polyester Web
- Material: Polyester Web
- Product Color: Yel

Dimensions and Classifications

- Overall Length (Imperial): 1.4 ft

3M™ DBI-SALA® Web D-ring Extension Anchor 1231117, Polyester, 1.5 ft

Part Number 1231117 3M Product Number 1231117 3M ID 7012601516

Details

- Extends dorsal harness D-ring (or overhead anchor point)
- High strength D-ring tie-off point
- Constructed with abrasion resistant materials
- Built-in wear indicator

Typical properties

- Anchor Hook Material: Zinc Plated Steel
- Brands: DBI-SALA®
- Case Quantity: 1
- Connected Safety ID Equipped: Yes
- Harness Connection Hook Material: Zinc Plated Steel
- Lanyard Material: Polyester Web
- Material: Polyester Web
- Net Weight (Metric): 0.58 kg
- P

Dimensions and Classifications

- Overall Length (Imperial): 1.5 ft
- Overall Length (Metric): 0.5 m

3M™ Protecta® Energy Absorbing Lanyards

Details

Energy absorbing design reduces fall arrest forces
Variety of web material options available
Select models equipped with impact indicator

Typical properties

Anchor Connection Type: None, Rebar Hook, Snap Hook, Tie-Back Hook
Anchor Hook Material: Zinc Plated Steel
Anchor Hook Material: Zinc Plated Steel
Attachment Type: None
Case Quantity: 1
Connected Safety ID Equipped: No
Energy Absorber Class: 6 ft (1

Dimensions and Classifications

Overall Length (Imperial): 3 ft, 4 ft, 6 ft, 18.5 in, 25 ft
Overall Length (Metric): 0.914 m, 1.829 m

3M™ Probed Reusable Respirator Assembly 6300Q, Large 4 EA/Case

3M Product Number 6300Q 3M ID 7000126031 UPC 00051138289218

Details

Respirator assembly for quantitative fit testing on 3M Respirators 6000 Series
Assembly includes probed facepiece and P100 filters
Fit test assesses the fit of respirator to wearer's face
Probe inside the facemask allows measurement of leakage into the respirator
Quantitative fit testing provides numerical results for documentation purposes

Typical properties

Accessories: No
Brands: 3M™
Case Quantity: 4
Clip-on Welding Shield: No
Compatible with 3M™ PAPR Systems: No
Compatible with 3M™ Supplied Air System: Yes
Compatible with Welding Shield: Yes
Cool Flow™ Exhalation Valve: No
Drop-down Feature: Yes
E

3M™ Probed Reusable Respirator Assembly 6100Q, Small 4 EA/Case

3M Product Number 6100Q 3M ID 7000148501 UPC 50051138289190

Details

Respirator assembly for quantitative fit testing on 3M Respirators 6000 Series
Assembly includes probed facepiece and P100 filters
Fit test assesses the fit of respirator to wearer's face
Probe inside the facemask allows measurement of leakage into the respirator
Quantitative fit testing provides numerical results for documentation purposes

Typical properties

Accessories: No
Brands: 3M™
Case Quantity: 4
Clip-on Welding Shield: No
Compatible with 3M™ PAPR Systems: No
Compatible with 3M™ Supplied Air System: Yes
Compatible with Welding Shield: Yes
Cool Flow™ Exhalation Valve: No
Drop-down Feature: Yes
E

3M™ Virtua™ Reader Protective Eyewear 11515-00000-20 Clear Anti-Fog Lens, Clear Temple, +2.5 Diopter 20 EA/Case

3M Product Number 11515-00000-20 3M ID 7000127513 UPC 10078371621213

Details

Molded-in magnifying diopters
Unisex style
Wraparound coverage

Typical properties

Anti Fog Lens: Yes
Brands: Virtua™
Case Quantity: 20
Class: Economy
Comfort Features: Lightweight, Wraparound lens
Diopter: 2.5
Eyewear Range: Economy
Frame Color: Clear
Frame Material: Plastic
Frame Style: Frameless
Hard Coat Lens: No
Lens Coa

3M™ Virtua™ Reader Protective Eyewear 11513-00000-20 Clear Anti-Fog Lens, Clear Temple, +1.5 Diopter 20 EA/Case

3M Product Number 11513-00000-20 3M ID 7000127511 UPC 10078371621190

Details

Molded-in magnifying diopters
Unisex style
Wraparound coverage

Typical properties

Anti Fog Lens: Yes
Brands: Virtua™
Case Quantity: 20
Class: Economy
Comfort Features: Lightweight, Wraparound lens
Diopter: 1.5
Eyewear Range: Economy
Frame Color: Clear
Frame Material: Plastic
Frame Style: Frameless
Hard Coat Lens: No
Lens Coa

3M™ Virtua™ Reader Protective Eyewear 11514-00000-20 Clear Anti-Fog Lens, Clear Temple, +2.0 Diopter 20 EA/Case

3M Product Number 11514-00000-20 3M ID 7000127512 UPC 10078371621206

Details

Molded-in magnifying diopters
Unisex style
Wraparound coverage

Typical properties

Anti Fog Lens: Yes
Brands: Virtua™
Case Quantity: 20
Class: Economy
Comfort Features: Lightweight, Wraparound lens
Diopter: 2.0
Eyewear Range: Economy
Frame Color: Clear
Frame Material: Plastic
Frame Style: Frameless
Hard Coat Lens: No
Lens Coa

3M™ DBI-SALA® Sealed-Blok™ Assisted Rescue Pole/Tool for RSQ Self-Retracting Lifeline 3500201, 6 - 12 ft

Part Number 3500201 3M Product Number 3500201 3M ID 7012819171

Details

First-Man-Up™ pole with RSQ assisted rescue tool
Designed for Sealed-Blok™ with RSQ feature
6 ft. to 12 ft. (1.8-3.6 m) adjustable pole
Aluminum assisted rescue tool
Durable fiberglass and aluminum construction
Compact and lightweight design

Typical properties

Brands: DBI-SALA®
Case Quantity: 1
Connected Safety ID Equipped: No
Product Color: Silver, Yellow
Product Series: Sealed-Blok™
Product Type: Pole with RSQ Assisted Rescue Tool (For SRL)
Recommended Industry: Construction, General Industrial, Mining,

Dimensions and Classifications

Overall Length (Imperial): 6 ft

3M™ Yellow Neons™ Test Plugs 393-2014-50, Large 50/Case

3M Product Number 393-2014-50 3M ID 7000148551 UPC 10078371659490

Details

Test Probe for E-A-Rfit™ system

3M™ Yellow Neon™ Large Test Probe

3M PSD products are for occupational use only

*The NRR may overestimate the hearing protection provided during typical use

Typical properties

Brands: 3M™

Earplug Shape: Tapered

Material: Polyurethane

Product Color: Neon Yellow

Product Type: Probed Test Earplug

Recommended Application: Health & Safety Testing

eClass 14 Classification Group: 40270102

3M™ E-A-Rsoft™ Yellow Neons™ Probed Test Plugs 393-2000-50, 50 EA/Case

3M Product Number 393-2000-50 3M ID 7100069736 UPC 10080529190731

Details

These test earplugs are modified with a probe tube for use during earplug fit testing with the 3M™ E-A-Rfit™ Validation System

50 pair per case

3M PSD products are for occupational use only

*The NRR may overestimate the hearing protection provided during typical use

Typical properties

Brands: 3M™

Case Quantity: 50

Earplug Shape: Tapered

Material: Polyurethane

Product Color: Yellow

Product Series: E-A-Rfit

Product Type: Probed Test Earplug

Recommended Application: Health & Safety Testing

eClass 14 Classification Group: 40270102

3M™ DBI-SALA® Nano-Lok™ Self-Retracting Lifeline with Anchor Hook

Details

- Swiveling anchorage loop with carabiner
- Quick activating speed sensing brake system
- Self-locking snap hook on lifeline
- Compact & lightweight design
- Durable thermoplastic housing
- High capacity external energy absorber and impact indicator
- RFID equipped and compatible with inventory management system
- Available in multiple styles and configurations

Typical properties

- ANSI Class Level: Class 1
- Anchor Connection Type: Carabiner, Rebar Hook, Snap Hook
- Anchor Hook Material: Aluminum, Zinc Plated Steel
- Anchor Hook Material: Aluminum, Zinc Plated Steel
- Average Arrest Force (Imperial): 1125 lbf (ANSI), 1125 lbf (OSHA 130)

Dimensions and Classifications

- Overall Length (Imperial): 6 ft, 8 ft
- Overall Length (Metric): 1.83 m, 2.4 m

3M™ Maxim™ Elite 1000 Series Safety Glasses

Details

Stylish wrap-around lens design
Lightweight rubber painted matte frame material with embossed 3M logo
Performance lens tints including photochromic and polarized help ensure you see clearly while minimizing glare
Choose from models with anti-fog/anti-scratch or 3M™ Scotchgard™ Anti-Fog coating
U6 rated polycarbonate lenses absorb 99.9% of UVA, UVB, and UVC rays between 200 nm and 380 nm
Workers can feel confident wearing 3M eye protection that meets the Impact-Rated Protector requirement of the ANSI-ISEA Z87.1 Standard

Typical properties

Anti Fog Lens: Yes
Case Quantity: 20
Class: Value
Comfort Features: Extra wide viewing range, Integrated sideshields, Polycarbonate, Rubber temple tips, Soft Temples, Sporty wraparound frame, Wide wrap around lens
Frame Color: Black
Frame Material: R

3M™ DBI-SALA® Advanced™ Carrying Bag 8517567, 1 EA

Part Number 8517567 3M Product Number 8517567 3M ID 7100214171

Details

- Portable davit base includes three pieces
- Adjustable width base
- Adjustable foot-leveling system
- Built-in level indicator
- Corrosion-resistant aluminum construction
- Easy to set-up and dismantle without tools

Typical properties

- Brands: DBI-SALA®
- Case Quantity: 1
- Connected Safety ID Equipped: No
- For Use With: Digital Winch
- Net Weight (Imperial): 2.3 lb
- Net Weight (Metric): 1 kg
- Product Color: Black
- Product Series: Advanced™
- Product Type: Equipment Carrying & Storage Bag

3M™ DBI-SALA® Confined Space Carrying Bag 8513329

Part Number 8513329 3M Product Number 8513329 3M ID 7100230446

Details

- Portable davit base includes three pieces
- Adjustable width base
- Adjustable foot-leveling system
- Built-in level indicator
- Corrosion-resistant aluminum construction
- Easy to set-up and dismantle without tools

Typical properties

- Brands: DBI-SALA®
- Case Quantity: 1
- Connected Safety ID Equipped: No
- For Use With: Aluminum Tripods
- Net Weight (Imperial): 3.7 lb
- Net Weight (Metric): 1.7 kg
- Product Color: Black
- Product Series: Advanced™
- Product Type: Equipment Carrying & Storage

3M™ DBI-SALA® Sealed-Blok™ Cable Assembly

Details

Ergonomic cable handle equipped with 3M™ Connected Safety ID (CSID)
SRL will not operate if installed incorrectly
Housing does not need to be opened

Typical properties

Case Quantity: 1
Connected Safety ID Equipped: Yes
Lifeline Material: Galvanized Cable
Material: Galvanized Steel Cable, Stainless Steel Cable
Net Weight (Imperial): 4.7 lb, 6.7 lb, 9.3 lb, 11.9 lb
Net Weight (Metric): 2.1 kg, 3 kg, 4.2 kg, 5.4 kg
P

Dimensions and Classifications

Overall Length (Imperial): 15 ft, 25 ft, 50 ft, 130 ft, 175 ft
Overall Length (Metric): 15 m, 25 m, 40 m

3M™ DBI-SALA® SecuraSpan™ Rebar/Shear Stud Horizontal Lifeline System 7400660, 1 EA

3M ID 7100188826 UPC 00840779005000

Details

Complete system includes two stanchions with tie-back and cable assemblies.
Various components and lengths available with spans up to 60 ft (18.3 m)
Metal energy absorber limits fall arrest forces
Equipped with RFID
3/8 in. (9.5 mm) 7x19 galvanized cable lifeline
Fits rebar or shear stud 1/2 in. to 1 in. diameter (#4 to #8 rebar) and 4 in. to 12 in. center to center (10.1-30.5 cm)
Single and multi-span indefinite length system configurations
Pass-thru 100% tie-off protection
Simple chain tie-back connection
Top mounted adjustment system
Lightweight, durable, and portable design
Equipped with 3M™ Connected Safety ID (CSID)

Typical properties

Brands: DBI-SALA®
Case Quantity: 1
Connected Safety ID Equipped: Yes
Install Type: Temporary/Portable
Lifeline Length (Imperial): 60 ft
Lifeline Length (Metric): 18.28 m
Lifeline Material: Galvanized Cable
Maximum Number of Workers: 2 Per Span, 6 T

Dimensions and Classifications

Overall Length (Imperial): 60 ft

3M™ DBI-SALA® Vacuum Anchor Lifeline System Compressed Air Cylinder 2200085

Part Number 2200085 3M Product Number 2200085 3M ID 7100280607

Details

Compact and lightweight aluminum design is easy to transport, install, and use
Provides a secure tie-off point on smooth, non-porous surfaces using vacuum technology

Approved for horizontal lifeline use

Heavy-duty storage and transport case

Compressed gas cylinder for vacuum anchor lifeline system

Increases portability for vacuum anchor system

Accommodates air or nitrogen

48 cubic inch, 3,000 psi

Built-in volume gauge

Typical properties

Brands: DBI-SALA®

Case Quantity: 1

Connected Safety ID Equipped: No

For Use With: Mobi-Lok™ SCVA

Install Type: Reusable

Material: Aluminum

Net Weight (Imperial): 3.4 lb

Net Weight (Metric): 1.5 kg

Product Color: Black

Product Series: Mobi-Lok™

P

3M™ DBI-SALA® Advanced™ Carrying Bag 8513330, 1 EA

Part Number 8513330 3M Product Number 8513330 3M ID 7100214247

Details

Carrying bags for Confined Space equipment
Polyester construction
Built-in web carrying handles
Zipper closure
Recommended for use in multiple industries

Typical properties

Brands: DBI-SALA®
Net Weight (Imperial): 7.3 lb
Net Weight (Metric): 3.3 kg
Product Series: Advanced™
Product Type: Carrying Bag
Recommended Industry: Construction, General Industrial, Mining, Oil & Gas,
Transportation, Utilities
eClass 14 Classific

3M™ DBI-SALA® ExoFit NEX™ Lumbar Wear Pads For Wind Energy Harness Belt 9505504, Small/Medium

Part Number 9505504 3M Product Number 9505504 3M ID 7012821699

Details

- Replaceable lumbar protector
- Fits ExoFit NEX™ wind energy harness belt - Small or Medium Size
- Protects web from damage during climb
- Durable nylon construction
- Compact and lightweight design

Typical properties

- Brands: DBI-SALA®
- Case Quantity: 1
- Connected Safety ID Equipped: No
- For Use With: ExoFit NEX™ Wind Energy Harness
- Net Weight (Imperial): 0.3 lb
- Net Weight (Metric): 0.1 kg
- Product Color: Blue
- Product Series: ExoFit NEX™
- Product Type: Lumbar Wear P

3M™ Versaflo™ Replacement Forehead Seal M-154, for M-100 Series Face Shields, 1 EA/Case

3M Product Number M-154 3M ID 7000127602 UPC 00051131173149

Details

Replacement part for 3M™ Versaflo™ M-100 Series Faceshields

Typical properties

Brands: Versaflo™

Case Quantity: 1

Compatible With: 3M™ Versaflo™ M-100 Faceshield

Headgear Type: Headtop with clear visor

High Heat: No

Product Color: Black

Product Series: M-Series

Product Type: Face Seal

3M™ Versaflo™ Replacement Forehead Seal M-354, for M-300 Series Hard Hats, 1 EA/Case

3M Product Number M-354 3M ID 7000127680 UPC 00051131173200

Details

Replacement part for 3M™ Versaflo™ M-300 Series Hardhats

Typical properties

Brands: Versaflo™

Case Quantity: 1

Compatible With: 3M™ Versaflo™ M-300 Helmets

Headgear Type: Hardhat with Faceshield

High Heat: No

Product Color: Black

Product Series: M-Series

Product Type: Face Seal

3M™ PELTOR™ Optime™ 95 Folding Earmuffs H6F/V, Over-the-Head, 10 EA/Case

3M Product Number H6F/V 3M ID 7000002328 UPC 10093045080639

Details

Folding - Cups fold up into the headband for compact storage
For noise levels up to 95 dBA
Stainless steel construction resists bending and warping
Earcup pivot points tilt for optimum comfort and efficiency
Noise Reduction Rating (NRR)*: 21 dB. CSA Class B

Typical properties

Attenuation Rating: 21.0 Decibel
Bluetooth: No
Brands: PELTOR™
Case Quantity: 10
Corded: No
Dielectric: No
Earmuff Style: Over the Head
Electrically Insulated: No
Hearing Protection Style: Over-the-Head
Material: ABS
Metal Detectable: No
Moistu

3M™ Headgear & Faceshield Combinations

Details

Five-position crown strap

Offers face protection for many jobs and tasks where liquid and chemical splashes may occur

Safety system comes with headgear and faceshield together

Typical properties

Case Quantity: 5

For Use With: Head and Face Protection Combinations, W Series Faceshields

Material: Polycarbonate, Propionate

Product Color: Transparent

Product Type: Head and Face Combinations

Recommended Application: Assembly, Cleaning, Demolition

Dimensions and Classifications

Overall Height (Imperial): 5.5 in, 14 in

Overall Height (Metric): 13.97 cm, 35.56 cm

Overall Length (Imperial): 9 in, 10 in

Overall Length (Metric): 22.86 cm, 25.4 cm

Overall Width (Imperial): 9 in, 14.5 in

Overall Width (Metric): 22.86 cm, 36.83 cm

3M™ VFlex™ Health Care Particulate Respirator & Surgical Mask 1800 Series

Details

V-shaped pleats expand for ease of breathing and flex with mouth movement for talking

NIOSH approved: N95

FDA cleared for use as surgical mask

Fluid resistant and disposable

3M proprietary filter media and pleats help make breathing easy

Uniquely designed tabs for respirator positioning on the face

Available in two sizes to fit a broad range of faces

Adjustable noseclip helps provide a custom and secure seal

Patented. See 3M.com/patent

Typical properties

Advanced Electrostatic Media: Yes

BFE: > 99%

Braided Comfort Strap: No

Exhalation Valve: No

Faceseal: No

Features: Advanced Electrostatic Media

Filter Class: N95

Flame Resistance (ASTM D2859-96): Yes

Fluid Resistant (ASTM F1862): Yes

Inner Packs

3M™ Supplied Air Hoses & Hose Assemblies

Details

Available in various lengths
Available with various fittings

Typical properties

Airline Hose Length (Imperial): 25 ft
Airline Hose Length (Metric): 7.62 m
CFM Capacity per Minute: 100 CFM, 50 CFM
Case Quantity: 1
Compatible With: Hose 3M W-9435; Breathing Tube BT-30; Hoods Versaflo: S-657; S-855 and S-857; Helmets Versaflo: M-106

Dimensions and Classifications

Overall Length (Imperial): 25 ft, 50 ft, 100 ft
Overall Length (Metric): 7.62 m, 15.24 m, 30.48 m

3M™ Spark Arrestor TR-362, for Versaflo™ TR-300+ PAPR 2 ea/Bag

3M Product Number TR-362 3M ID 7000052905 UPC 00051131173705

Details

Helps protect the HE filter and PAPR unit from damage due to sparks or other hot materials

For use with M-Series headgear configurations

Typical properties

Brands: Versaflo™

Case Quantity: 2/bag

Compatible With: 3M™ Versaflo™ TR-300 Series PAPR, 3M™ Versaflo™ TR-300N+ Series PAPR

Hazard Type: Silica

Material: Metal

Product Color: Metal

Product Series: TR-300, TR-300+

Product Type: Spark Arrestor

Reco

3M™ Adflo™ Blower Unit with Cover, 35-1099-01, 1 EA/CASE

3M Product Number 35-1099-01 3M ID 7100200559 UPC 00076308943684

Details

Powered Air Purifying Respirator (PAPR) system
For use with 3M™ Speedglas™ Welding Helmets

Typical properties

Battery Life: PAPR: up to 12 hours

Battery Type: PAPR: Lithium ion

Brands: Adflo™

Cartridge or Filter Included: HE Filter

Case Quantity: 1

Compatible Respirator: 3M Adflo Powered Air Purifying Respirator, Adflo

Features: Respiratory Spare Part

Incl

3M™ Versaflo™ TR-300 Series PAPR Filters

Details

For use with 3M™ TR-300 Series PAPRs
High efficiency particulate filter
Individually packaged
Simple to install

Typical properties

Case Quantity: 5,40
Compatible Respirator: TR-300 Series
Compatible with 3M™ PAPR Systems: Yes
Hazard Type: Silica
Mounting Type: Belt-mounted
NIOSH Cartridge or Filter Assigned Color Coding: Magenta
Product Color: Gray
Product Series: TR-Series
P

3M™ Exhalation Valve Cover FF-400-09, 5 EA/Case

3M Product Number FF-400-09 3M ID 7000052740 UPC 50051135894816

Details

Replacement part to use with 3M Ultimate FX Full Facepiece Reusable Respirators FF-401, FF-402, and FF-403 (sold separately)
Designed for use with the 3M Ultimate FX Full Facepiece Reusable Respirators (sold separately)
Maintains original performance standards of facepiece
Cover protects exhalation valve
Replaceable part can potentially result in respiratory equipment cost savings

Typical properties

Accessories: Yes
Boxes per Case: 5
Brands: 3M™
Case Quantity: 5/case
Clip-on Welding Shield: No
Compatible with 3M™ PAPR Systems: No
Compatible with 3M™ Supplied Air System: Yes
Compatible with Welding Shield: No
Cool Flow™ Exhalation Valve: Yes

3M™ Exhalation Valve Cover 7918, 20 EA/Case

3M Product Number 7918 3M ID 7000126043 UPC 50051138290950

Details

Approved 3M replacement part
Designed for 3M Full Facepiece Respirator 7800S (sold separately)
Replacement part can extend service life of facepiece
Replaceable part can potentially result in respiratory equipment cost savings
Valve cover maintains original service performance of facepiece

Typical properties

Accessories: Yes
Brands: 3M™
Case Quantity: 5/pack
Clip-on Welding Shield: Yes
Compatible with 3M™ PAPR Systems: Yes
Compatible with 3M™ Supplied Air System: Yes
Compatible with Welding Shield: No
Cool Flow™ Exhalation Valve: No
Drop-down Feature:

3M™ Welding Inside Protection Plates

Details

Replace 3M™ Speedglas™ Inner Cover Plate when it becomes deeply pitted or too dirty to clean

Helps protect your welding lens

Designed to be used with 3M™ Speedglas™ Welding Helmet and Lens

Regularly clean with a lint-free tissue or cloth

For highest possible safety and comfort, regularly check your equipment for worn or damaged parts

Typical properties

ADF Dark State Shades: Variable 5, 8-13

ADF Model: 9000F, 9000XF, 9002D, 9002V, 9002X, 9100V, 9100X, 9100XX, G5-02, G5TW, G5VC, None

ADF Shade Range: Variable 5, 8-13

ADF Viewing Area (Metric): 54 mm x 107 mm, 73 mm x 107 mm

ADF Viewing Area (hwx): 2.

**3M™ Speedglas™ Flip-Up Mechanism 27-0099-53, for 9100MP
Welding Helmets,
1 EA/Case**

3M Product Number 27-0099-53 3M ID 7000128224 UPC 00051141558134

Details

Flip-up Mechanism
Replacement Part
9100 MP

Typical properties

Brands: Speedglas™
Case Quantity: 1
Compatible Welding Helmet: 9100 MP Welding Helmets
Features: Respiratory Accessory
For Use With: 3M™ Speedglas™ 9100MP Welding Helmets
Product Color: Black
Product Series: 9100, 9100 MP, 9100-Air
Recommended Appl

3M™ Speedglas™ SL Welding Helmet Spatter Protector 05-0695-00, 1 EA/Case

3M Product Number 05-0695-00 3M ID 7100049368 UPC 00051131172258

Details

Satter Protection
Replacement Part

Typical properties

Brands: Speedglas™
Case Quantity: 1
Compatible Welding Helmet: SL Series
Features: SL Series Accessory
Product Series: SL
Recommended Application: Assembly, Facility Maintenance, Grinding, Machine
Operation, Sanding, Welding
Recommended Industry: Co

3M™ DBI-SALA® Smart Lock Self-Retracting Lifeline 3503823, Stainless Steel Cable, Blue, 50 ft. (15m)

Part Number 3503823 3M Product Number 3503823 3M ID 7100204328

Details

Available in multiple lifeline lengths and lifeline material configurations
Lightweight thermoplastic housing with built in carrying handle
Swiveling anchorage point and carabiner included
Patent pending dual label system located within ergonomic cable bumper stop to
simplify inspections and reduce the need for replacement
Swiveling snap hook with impact indicator
RFID located in cable handle

Typical properties

Anchor Connection Type: Swivel Snap Hook
Anchor Hook Material: Stainless Steel
Brands: DBI-SALA®
Carabiner/Hook Material: Stainless Steel
Connected Safety ID Equipped: Yes
Connector: Swivel Hook
Dimensions: 25" x 10" x 4.25"
Features: 420 lb Capaci

Dimensions and Classifications

Overall Length (Imperial): 50 ft

3M™ DBI-SALA® Smart Lock Self-Retracting Lifeline 3503821, Stainless Steel Cable, Blue, 35 ft. (11m)

Part Number 3503821 3M Product Number 3503821 3M ID 7100204326

Details

Available in multiple lifeline lengths and lifeline material configurations
Lightweight thermoplastic housing with built in carrying handle
Swiveling anchorage point and carabiner included
Patent pending dual label system located within ergonomic cable bumper stop to simplify inspections and reduce the need for replacement
Swiveling snap hook with impact indicator
RFID located in cable handle

Typical properties

Anchor Connection Type: Swivel Snap Hook
Anchor Hook Material: Stainless Steel
Brands: DBI-SALA®
Carabiner/Hook Material: Stainless Steel
Connected Safety ID Equipped: Yes
Connector: Swivel Hook
Dimensions: 25" x 10" x 4.25"
Features: 420 lb Capaci

Dimensions and Classifications

Overall Length (Imperial): 35 ft

3M™ DBI-SALA® Smart Lock Self-Retracting Lifeline 3503878, 50 ft, Galvanized Cable, Class 1

3M Product Number 3503878 3M ID 7100306995 UPC 00648250239452

Details

Available in multiple lifeline lengths and lifeline material configurations
Lightweight thermoplastic housing with built in carrying handle
Swiveling anchorage point and carabiner included
Patent pending dual label system located within ergonomic cable bumper stop to simplify inspections and reduce the need for replacement
Swiveling snap hook with impact indicator
RFID located in cable handle

Typical properties

ANSI Class Level: Class 1
Anchor Connection Type: Carabiner
Anchor Hook Material: Zinc Plated Steel
Anchor Hook Material: Zinc Plated Steel
Average Arrest Force (Imperial): 1125 lbf (ANSI), 1125 lbf (OSHA 130 lb - 310 lb)
Average Arrest Force (Metric)

Dimensions and Classifications

Overall Length (Imperial): 50 ft
Overall Length (Metric): 15.2 m

3M™ DBI-SALA® Smart Lock Self-Retracting Lifeline 3503872, 20 ft, Galvanized Cable, Class 1

3M Product Number 3503872 3M ID 7100306993 UPC 00648250239391

Details

- Available in multiple lifeline lengths and lifeline material configurations
- Lightweight thermoplastic housing with built in carrying handle
- Swiveling anchorage point and carabiner included
- Patent pending dual label system located within ergonomic cable bumper stop to simplify inspections and reduce the need for replacement
- Swiveling snap hook with impact indicator
- RFID located in cable handle

Typical properties

- ANSI Class Level: Class 1
- Anchor Connection Type: Carabiner
- Anchor Hook Material: Zinc Plated Steel
- Anchor Hook Material: Zinc Plated Steel
- Average Arrest Force (Imperial): 1125 lbf (ANSI), 1125 lbf (OSHA 130 lb - 310 lb)
- Average Arrest Force (Metric)

Dimensions and Classifications

- Overall Length (Imperial): 20 ft
- Overall Length (Metric): 6.1 m

3M™ DBI-SALA® Smart Lock Self-Retracting Lifeline 3503801, Stainless Steel Cable, Blue, 30 ft. (10m) 1 Ea/Case

Part Number 3503801 3M Product Number 3503801 3M ID 7100204324

Details

Available in multiple lifeline lengths and lifeline material configurations
Lightweight thermoplastic housing with built in carrying handle
Swiveling anchorage point and carabiner included
Patent pending dual label system located within ergonomic cable bumper stop to simplify inspections and reduce the need for replacement
Swiveling snap hook with impact indicator
RFID located in cable handle

Typical properties

Anchor Connection Type: Swivel Snap Hook
Anchor Hook Material: Stainless Steel
Brands: DBI-SALA®
Carabiner/Hook Material: Stainless Steel
Connected Safety ID Equipped: Yes
Connector: Swivel Hook
Dimensions: 23.5" x 9" x 4"
Features: 420 lb Capacity

Dimensions and Classifications

Overall Length (Imperial): 30 ft

3M™ DBI-SALA® Smart Lock Self-Retracting Lifeline 3503879, Stainless Steel Cable, 40 ft. (12 m)

3M Product Number 3503879 3M ID 7100307005 UPC 00648250239469

Details

Available in multiple lifeline lengths and lifeline material configurations
Lightweight thermoplastic housing with built in carrying handle
Swiveling anchorage point and carabiner included
Patent pending dual label system located within ergonomic cable bumper stop to simplify inspections and reduce the need for replacement
Swiveling snap hook with impact indicator
RFID located in cable handle

Typical properties

ANSI Class Level: Class 1
Anchor Connection Type: Swivel Snap Hook
Anchor Hook Material: Zinc Plated Steel
Anchor Hook Material: Stainless Steel
Average Arrest Force (Imperial): 1125 lbf (ANSI), 1125 lbf (OSHA 130 lb - 310 lb)
Average Arrest Force (M)

Dimensions and Classifications

Overall Length (Imperial): 40 ft
Overall Length (Metric): 12.2 m

3M™ DBI-SALA® Lad-Saf™ Swaged Cable 6104280, 3/8 Inch, 1x7, Galvanized Steel, 280 FT

Part Number 6104280 3M Product Number 6104280 3M ID 7100184411

Details

Robust cable tensioning and termination

Durable, high-strength steel construction that allows for maintenance-free longevity

Cable comes pre-cut and swaged, allowed for quick and easy installation and tensioning

Comes in stainless or galvanized steel, and in 1x7 or 7x19 versions

Typical properties

Brands: DBI-SALA®

Cable Preformation: Left, Regular Lay

Cable Strand: 1 x 7

Case Quantity: 1

Connected Safety ID Equipped: No

Install Type: Permanent

Lifeline Length (Imperial): 280 ft

Lifeline Length (Metric): 85.34 m

Lifeline Material: Galvanize

Dimensions and Classifications

Overall Width (Imperial): 0.375 in

Overall Width (Metric): 9.525 mm

3M™ DBI-SALA® Lad-Saf™ Swaged Cable 6104240, 3/8 Inch, 1x7, Galvanized Steel, 240 FT

Part Number 6104240 3M Product Number 6104240 3M ID 7100184409

Details

Robust cable tensioning and termination

Durable, high-strength steel construction that allows for maintenance-free longevity

Cable comes pre-cut and swaged, allowed for quick and easy installation and tensioning

Comes in stainless or galvanized steel, and in 1x7 or 7x19 versions

Typical properties

Brands: DBI-SALA®

Cable Preformation: Left, Regular Lay

Cable Strand: 1 x 7

Case Quantity: 1

Connected Safety ID Equipped: No

Install Type: Permanent

Lifeline Length (Imperial): 240 ft

Lifeline Length (Metric): 73.15 m

Lifeline Material: Galvanize

Dimensions and Classifications

Overall Width (Imperial): 0.375 in

Overall Width (Metric): 9.525 mm

3M™ DBI-SALA® Lad-Saf™ Swaged Cable 6104150, 3/8 Inch, 1x7, Galvanized Steel, 150 FT

Part Number 6104150 3M Product Number 6104150 3M ID 7100184402

Details

Robust cable tensioning and termination

Durable, high-strength steel construction that allows for maintenance-free longevity

Cable comes pre-cut and swaged, allowed for quick and easy installation and tensioning

Comes in stainless or galvanized steel, and in 1x7 or 7x19 versions

Typical properties

Brands: DBI-SALA®

Cable Preformation: Left, Regular Lay

Cable Strand: 1 x 7

Case Quantity: 1

Connected Safety ID Equipped: No

Install Type: Permanent

Lifeline Length (Imperial): 150 ft

Lifeline Length (Metric): 45.72 m

Lifeline Material: Galvanize

Dimensions and Classifications

Overall Width (Imperial): 0.375 in

Overall Width (Metric): 9.525 mm

3M™ DBI-SALA® Lad-Saf™ Swaged Cable 6104180, 3/8 Inch, 1x7, Galvanized Steel, 180 FT

Part Number 6104180 3M Product Number 6104180 3M ID 7100184405

Details

Robust cable tensioning and termination

Durable, high-strength steel construction that allows for maintenance-free longevity

Cable comes pre-cut and swaged, allowed for quick and easy installation and tensioning

Comes in stainless or galvanized steel, and in 1x7 or 7x19 versions

Typical properties

Brands: DBI-SALA®

Cable Preformation: Left, Regular Lay

Cable Strand: 1 x 7

Case Quantity: 1

Connected Safety ID Equipped: No

Install Type: Permanent

Lifeline Length (Imperial): 180 ft

Lifeline Length (Metric): 54.86 m

Lifeline Material: Galvanize

Dimensions and Classifications

Overall Width (Imperial): 0.375 in

Overall Width (Metric): 9.525 mm

3M™ DBI-SALA® Lad-Saf™ Swaged Cable 6104120, 3/8 Inch, 1x7, Galvanized Steel, 120 FT

Part Number 6104120 3M Product Number 6104120 3M ID 7100184399

Details

Robust cable tensioning and termination

Durable, high-strength steel construction that allows for maintenance-free longevity

Cable comes pre-cut and swaged, allowed for quick and easy installation and tensioning

Comes in stainless or galvanized steel, and in 1x7 or 7x19 versions

Typical properties

Brands: DBI-SALA®

Cable Preformation: Left, Regular Lay

Cable Strand: 1 x 7

Case Quantity: 1

Connected Safety ID Equipped: No

Install Type: Permanent

Lifeline Length (Imperial): 120 ft

Lifeline Length (Metric): 36.57 m

Lifeline Material: Galvanize

Dimensions and Classifications

Overall Width (Imperial): 0.375 in

Overall Width (Metric): 9.525 mm

3M™ DBI-SALA® Lad-Saf™ Swaged Cable 6104140, 3/8 Inch, 1x7, Galvanized Steel, 140 FT

Part Number 6104140 3M Product Number 6104140 3M ID 7100184401

Details

Robust cable tensioning and termination

Durable, high-strength steel construction that allows for maintenance-free longevity

Cable comes pre-cut and swaged, allowed for quick and easy installation and tensioning

Comes in stainless or galvanized steel, and in 1x7 or 7x19 versions

Typical properties

Brands: DBI-SALA®

Cable Preformation: Left, Regular Lay

Cable Strand: 1 x 7

Case Quantity: 1

Connected Safety ID Equipped: No

Install Type: Permanent

Lifeline Length (Imperial): 140 ft

Lifeline Length (Metric): 42.67 m

Lifeline Material: Galvanize

Dimensions and Classifications

Overall Width (Imperial): 0.375 in

Overall Width (Metric): 9.525 mm

3M™ DBI-SALA® Lad-Saf™ Swaged Cable 6104085, 3/8 Inch, 1x7, Galvanized Steel, 85 FT

Part Number 6104085 3M Product Number 6104085 3M ID 7100184396

Details

Robust cable tensioning and termination

Durable, high-strength steel construction that allows for maintenance-free longevity

Cable comes pre-cut and swaged, allowed for quick and easy installation and tensioning

Comes in stainless or galvanized steel, and in 1x7 or 7x19 versions

Typical properties

Brands: DBI-SALA®

Cable Preformation: Left, Regular Lay

Cable Strand: 1 x 7

Case Quantity: 1

Connected Safety ID Equipped: No

Install Type: Permanent

Lifeline Length (Imperial): 85 ft

Lifeline Length (Metric): 25.9 m

Lifeline Material: Galvanized

Dimensions and Classifications

Overall Width (Imperial): 0.375 in

Overall Width (Metric): 9.525 mm

3M™ DBI-SALA® Lad-Saf™ Swaged Cable 6104095, 3/8 Inch, 1x7, Galvanized Steel, 95 FT

Part Number 6104095 3M Product Number 6104095 3M ID 7100184397

Details

Robust cable tensioning and termination

Durable, high-strength steel construction that allows for maintenance-free longevity

Cable comes pre-cut and swaged, allowed for quick and easy installation and tensioning

Comes in stainless or galvanized steel, and in 1x7 or 7x19 versions

Typical properties

Brands: DBI-SALA®

Cable Preformation: Left, Regular Lay

Cable Strand: 1 x 7

Case Quantity: 1

Connected Safety ID Equipped: No

Install Type: Permanent

Lifeline Length (Imperial): 95 ft

Lifeline Length (Metric): 28.95 m

Lifeline Material: Galvanized

Dimensions and Classifications

Overall Width (Imperial): 0.375 in

Overall Width (Metric): 9.525 mm

3M™ DBI-SALA® Lad-Saf™ Swaged Cable 6104065, 3/8 Inch, 1x7, Galvanized Steel, 65 FT

Part Number 6104065 3M Product Number 6104065 3M ID 7100184394

Details

Robust cable tensioning and termination
Durable, high-strength steel construction that allows for maintenance-free longevity
Cable comes pre-cut and swaged, allowed for quick and easy installation and tensioning
Comes in stainless or galvanized steel, and in 1x7 or 7x19 versions

Typical properties

Brands: DBI-SALA®
Cable Preformation: Left, Regular Lay
Cable Strand: 1 x 7
Case Quantity: 1
Connected Safety ID Equipped: No
Install Type: Permanent
Lifeline Length (Imperial): 65 ft
Lifeline Length (Metric): 19.81 m
Lifeline Material: Galvanized

Dimensions and Classifications

Overall Width (Imperial): 0.375 in
Overall Width (Metric): 9.525 mm

3M™ DBI-SALA® Lad-Saf™ Swaged Cable 6104035, 3/8 Inch, 1x7, Galvanized Steel, 35 FT

Part Number 6104035 3M Product Number 6104035 3M ID 7100184391

Details

Robust cable tensioning and termination

Durable, high-strength steel construction that allows for maintenance-free longevity

Cable comes pre-cut and swaged, allowed for quick and easy installation and tensioning

Comes in stainless or galvanized steel, and in 1x7 or 7x19 versions

Typical properties

Brands: DBI-SALA®

Cable Preformation: Left, Regular Lay

Cable Strand: 1 x 7

Case Quantity: 1

Connected Safety ID Equipped: No

Install Type: Permanent

Lifeline Length (Imperial): 35 ft

Lifeline Length (Metric): 10.66 m

Lifeline Material: Galvanized

Dimensions and Classifications

Overall Width (Imperial): 0.375 in

Overall Width (Metric): 9.525 mm

3M™ DBI-SALA® Lad-Saf™ Swaged Cable 6105170, 3/8 Inch, 1x7, Stainless Steel, 170 FT

Part Number 6105170 3M Product Number 6105170 3M ID 7100184428

Details

Robust cable tensioning and termination

Durable, high-strength steel construction that allows for maintenance-free longevity

Cable comes pre-cut and swaged, allowed for quick and easy installation and tensioning

Comes in stainless or galvanized steel, and in 1x7 or 7x19 versions

Typical properties

Anchor Connection Type: Swage

Brands: DBI-SALA®

Cable Preformation: Left, Regular Lay

Cable Strand: 1 x 7

Case Quantity: 1

Connected Safety ID Equipped: No

Install Type: Permanent

Lifeline Length (Imperial): 170 ft

Lifeline Length (Metric): 51.81

Dimensions and Classifications

Overall Width (Imperial): 0.375 in

Overall Width (Metric): 9.525 mm

3M™ DBI-SALA® Lad-Saf™ Swaged Cable 6105180, 3/8 Inch, 1x7, Stainless Steel, 180 FT

Part Number 6105180 3M Product Number 6105180 3M ID 7100184429

Details

Robust cable tensioning and termination

Durable, high-strength steel construction that allows for maintenance-free longevity

Cable comes pre-cut and swaged, allowed for quick and easy installation and tensioning

Comes in stainless or galvanized steel, and in 1x7 or 7x19 versions

Typical properties

Brands: DBI-SALA®

Cable Preformation: Left, Regular Lay

Cable Strand: 1 x 7

Case Quantity: 1

Connected Safety ID Equipped: No

Install Type: Permanent

Lifeline Length (Imperial): 180 ft

Lifeline Length (Metric): 54.86 m

Lifeline Material: Stainless

Dimensions and Classifications

Overall Width (Imperial): 0.375 in

Overall Width (Metric): 9.525 mm

3M™ DBI-SALA® Lad-Saf™ Swaged Cable 6105200, 3/8 Inch, 1x7, Stainless Steel, 200 FT

Part Number 6105200 3M Product Number 6105200 3M ID 7100184431

Details

Robust cable tensioning and termination

Durable, high-strength steel construction that allows for maintenance-free longevity

Cable comes pre-cut and swaged, allowed for quick and easy installation and tensioning

Comes in stainless or galvanized steel, and in 1x7 or 7x19 versions

Typical properties

Brands: DBI-SALA®

Cable Preformation: Left, Regular Lay

Cable Strand: 1 x 7

Case Quantity: 1

Connected Safety ID Equipped: No

Install Type: Permanent

Lifeline Length (Imperial): 200 ft

Lifeline Length (Metric): 60.96 m

Lifeline Material: Stainless

Dimensions and Classifications

Overall Width (Imperial): 0.375 in

Overall Width (Metric): 9.525 mm

3M™ DBI-SALA® Lad-Saf™ Swaged Cable 6105130, 3/8 Inch, 1x7, Stainless Steel, 130 FT

Part Number 6105130 3M Product Number 6105130 3M ID 7100184424

Details

Robust cable tensioning and termination

Durable, high-strength steel construction that allows for maintenance-free longevity

Cable comes pre-cut and swaged, allowed for quick and easy installation and tensioning

Comes in stainless or galvanized steel, and in 1x7 or 7x19 versions

Typical properties

Anchor Connection Type: Swage

Brands: DBI-SALA®

Cable Preformation: Left, Regular Lay

Cable Strand: 1 x 7

Case Quantity: 1

Connected Safety ID Equipped: No

Install Type: Permanent

Lifeline Length (Imperial): 130 ft

Lifeline Length (Metric): 39.62

Dimensions and Classifications

Overall Width (Imperial): 0.375 in

Overall Width (Metric): 9.525 mm

3M™ DBI-SALA® Lad-Saf™ Swaged Cable 6105140, 3/8 Inch, 1x7, Stainless Steel, 140 FT

Part Number 6105140 3M Product Number 6105140 3M ID 7100184425

Details

Robust cable tensioning and termination

Durable, high-strength steel construction that allows for maintenance-free longevity

Cable comes pre-cut and swaged, allowed for quick and easy installation and tensioning

Comes in stainless or galvanized steel, and in 1x7 or 7x19 versions

Typical properties

Anchor Connection Type: Swage

Brands: DBI-SALA®

Cable Preformation: Left, Regular Lay

Cable Strand: 1 x 7

Case Quantity: 1

Connected Safety ID Equipped: No

Install Type: Permanent

Lifeline Length (Imperial): 140 ft

Lifeline Length (Metric): 42.67

Dimensions and Classifications

Overall Width (Imperial): 0.375 in

Overall Width (Metric): 9.525 mm

3M™ DBI-SALA® Lad-Saf™ Swaged Cable 6105150, 3/8 Inch, 1x7, Stainless Steel, 150 FT

Part Number 6105150 3M Product Number 6105150 3M ID 7100184426

Details

Robust cable tensioning and termination

Durable, high-strength steel construction that allows for maintenance-free longevity

Cable comes pre-cut and swaged, allowed for quick and easy installation and tensioning

Comes in stainless or galvanized steel, and in 1x7 or 7x19 versions

Typical properties

Brands: DBI-SALA®

Cable Preformation: Left, Regular Lay

Cable Strand: 1 x 7

Case Quantity: 1

Connected Safety ID Equipped: No

Install Type: Permanent

Lifeline Length (Imperial): 150 ft

Lifeline Length (Metric): 45.72 m

Lifeline Material: Stainless

Dimensions and Classifications

Overall Width (Imperial): 0.375 in

Overall Width (Metric): 9.525 mm

3M™ DBI-SALA® Lad-Saf™ Swaged Cable 6105110, 3/8 Inch, 1x7, Stainless Steel, 110 FT

Part Number 6105110 3M Product Number 6105110 3M ID 7100184422

Details

Robust cable tensioning and termination

Durable, high-strength steel construction that allows for maintenance-free longevity

Cable comes pre-cut and swaged, allowed for quick and easy installation and tensioning

Comes in stainless or galvanized steel, and in 1x7 or 7x19 versions

Typical properties

Brands: DBI-SALA®

Cable Preformation: Left, Regular Lay

Cable Strand: 1 x 7

Case Quantity: 1

Connected Safety ID Equipped: No

Install Type: Permanent

Lifeline Length (Imperial): 110 ft

Lifeline Length (Metric): 33.52 m

Lifeline Material: Stainless

Dimensions and Classifications

Overall Width (Imperial): 0.375 in

Overall Width (Metric): 9.525 mm

3M™ DBI-SALA® Lad-Saf™ Swaged Cable 6105120, 3/8 Inch, 1x7, Stainless Steel, 120 FT

Part Number 6105120 3M Product Number 6105120 3M ID 7100184423

Details

Robust cable tensioning and termination

Durable, high-strength steel construction that allows for maintenance-free longevity

Cable comes pre-cut and swaged, allowed for quick and easy installation and tensioning

Comes in stainless or galvanized steel, and in 1x7 or 7x19 versions

Typical properties

Anchor Connection Type: Swage

Brands: DBI-SALA®

Cable Preformation: Left, Regular Lay

Cable Strand: 1 x 7

Case Quantity: 1

Connected Safety ID Equipped: No

Install Type: Permanent

Lifeline Length (Imperial): 120 ft

Lifeline Length (Metric): 36.57

Dimensions and Classifications

Overall Width (Imperial): 0.375 in

Overall Width (Metric): 9.525 mm

3M™ DBI-SALA® Lad-Saf™ Swaged Cable 6105095, 3/8 Inch, 1x7, Stainless Steel, 95 FT

Part Number 6105095 3M Product Number 6105095 3M ID 7100184421

Details

Robust cable tensioning and termination

Durable, high-strength steel construction that allows for maintenance-free longevity

Cable comes pre-cut and swaged, allowed for quick and easy installation and tensioning

Comes in stainless or galvanized steel, and in 1x7 or 7x19 versions

Typical properties

Brands: DBI-SALA®

Cable Preformation: Left, Regular Lay

Cable Strand: 1 x 7

Case Quantity: 1

Connected Safety ID Equipped: No

Install Type: Permanent

Lifeline Length (Imperial): 95 ft

Lifeline Length (Metric): 28.95 m

Lifeline Material: Stainless

Dimensions and Classifications

Overall Width (Imperial): 0.375 in

Overall Width (Metric): 9.525 mm

3M™ DBI-SALA® Lad-Saf™ Swaged Cable 6105065, 3/8 Inch, 1x7, Stainless Steel, 65 FT

Part Number 6105065 3M Product Number 6105065 3M ID 7100184418

Details

Robust cable tensioning and termination

Durable, high-strength steel construction that allows for maintenance-free longevity

Cable comes pre-cut and swaged, allowed for quick and easy installation and tensioning

Comes in stainless or galvanized steel, and in 1x7 or 7x19 versions

Typical properties

Brands: DBI-SALA®

Cable Preformation: Left, Regular Lay

Cable Strand: 1 x 7

Case Quantity: 1

Connected Safety ID Equipped: No

Install Type: Permanent

Lifeline Length (Imperial): 65 ft

Lifeline Length (Metric): 19.81 m

Lifeline Material: Stainless

Dimensions and Classifications

Overall Width (Imperial): 0.375 in

Overall Width (Metric): 9.525 mm

3M™ DBI-SALA® Lad-Saf™ Swaged Cable 6105015, 3/8 Inch, 1x7, Stainless Steel, 15 FT

Part Number 6105015 3M Product Number 6105015 3M ID 7100184413

Details

Robust cable tensioning and termination

Durable, high-strength steel construction that allows for maintenance-free longevity

Cable comes pre-cut and swaged, allowed for quick and easy installation and tensioning

Comes in stainless or galvanized steel, and in 1x7 or 7x19 versions

Typical properties

Anchor Connection Type: Swage

Brands: DBI-SALA®

Cable Preformation: Left, Regular Lay

Cable Strand: 1 x 7

Case Quantity: 1

Connected Safety ID Equipped: No

Install Type: Permanent

Lifeline Length (Imperial): 15 ft

Lifeline Length (Metric): 4.57 m

Dimensions and Classifications

Overall Width (Imperial): 0.375 in

Overall Width (Metric): 9.525 mm

3M™ DBI-SALA® Lad-Saf™ Swaged Cable 6105025, 3/8 Inch, 1x7, Stainless Steel, 25 FT

Part Number 6105025 3M Product Number 6105025 3M ID 7100184414

Details

Robust cable tensioning and termination

Durable, high-strength steel construction that allows for maintenance-free longevity

Cable comes pre-cut and swaged, allowed for quick and easy installation and tensioning

Comes in stainless or galvanized steel, and in 1x7 or 7x19 versions

Typical properties

Anchor Connection Type: Swage

Brands: DBI-SALA®

Cable Preformation: Left, Regular Lay

Cable Strand: 1 x 7

Case Quantity: 1

Connected Safety ID Equipped: No

Install Type: Permanent

Lifeline Length (Imperial): 25 ft

Lifeline Length (Metric): 7.62 m

Dimensions and Classifications

Overall Width (Imperial): 0.375 in

Overall Width (Metric): 9.525 mm

3M™ DBI-SALA® Lad-Saf™ Swaged Cable 6104300, 3/8 Inch, 1x7, Galvanized Steel, 300 FT

Part Number 6104300 3M Product Number 6104300 3M ID 7100184412

Details

Robust cable tensioning and termination

Durable, high-strength steel construction that allows for maintenance-free longevity

Cable comes pre-cut and swaged, allowed for quick and easy installation and tensioning

Comes in stainless or galvanized steel, and in 1x7 or 7x19 versions

Typical properties

Brands: DBI-SALA®

Cable Preformation: Left, Regular Lay

Cable Strand: 1 x 7

Case Quantity: 1

Connected Safety ID Equipped: No

Install Type: Permanent

Lifeline Length (Imperial): 300 ft

Lifeline Length (Metric): 91.44 m

Lifeline Material: Galvanize

Dimensions and Classifications

Overall Width (Imperial): 0.375 in

Overall Width (Metric): 9.525 mm

3M™ DBI-SALA® Lad-Saf™ Swaged Cable 6106090, 3/8 Inch, 7x19, Galvanized Steel, 90 FT

3M Product Number 6106090 3M ID 7100184448 UPC 00840779165896

Details

Robust cable tensioning and termination

Durable, high-strength steel construction that allows for maintenance-free longevity

Cable comes pre-cut and swaged, allowed for quick and easy installation and tensioning

Comes in stainless or galvanized steel, and in 1x7 or 7x19 versions

Typical properties

Brands: DBI-SALA®

Cable Preformation: Right. Regular Lay

Cable Strand: 7 x 19

Case Quantity: 1

Connected Safety ID Equipped: No

Install Type: Permanent

Lifeline Length (Imperial): 90 ft

Lifeline Length (Metric): 27.43 m

Lifeline Material: Galvaniz

Dimensions and Classifications

Overall Width (Imperial): 0.375 in

Overall Width (Metric): 9.525 mm

3M™ DBI-SALA® Lad-Saf™ Swaged Cable 6106095, 3/8 Inch, 7x19, Galvanized Steel, 95 FT

3M Product Number 6106095 3M ID 7100184449 UPC 00840779165902

Details

Robust cable tensioning and termination

Durable, high-strength steel construction that allows for maintenance-free longevity

Cable comes pre-cut and swaged, allowed for quick and easy installation and tensioning

Comes in stainless or galvanized steel, and in 1x7 or 7x19 versions

Typical properties

Brands: DBI-SALA®

Cable Preformation: Right. Regular Lay

Cable Strand: 7 x 19

Case Quantity: 1

Connected Safety ID Equipped: No

Install Type: Permanent

Lifeline Length (Imperial): 95 ft

Lifeline Length (Metric): 28.95 m

Lifeline Material: Galvaniz

Dimensions and Classifications

Overall Width (Imperial): 0.375 in

Overall Width (Metric): 9.525 mm

3M™ DBI-SALA® Lad-Saf™ Swaged Cable 6106100, 3/8 Inch, 7x19, Galvanized Steel, 100 FT

3M Product Number 6106100 3M ID 7100184450 UPC 00840779165919

Details

Robust cable tensioning and termination

Durable, high-strength steel construction that allows for maintenance-free longevity

Cable comes pre-cut and swaged, allowed for quick and easy installation and tensioning

Comes in stainless or galvanized steel, and in 1x7 or 7x19 versions

Typical properties

Brands: DBI-SALA®

Cable Preformation: Right. Regular Lay

Cable Strand: 7 x 19

Case Quantity: 1

Connected Safety ID Equipped: No

Install Type: Permanent

Lifeline Length (Imperial): 100 ft

Lifeline Length (Metric): 30.48 m

Lifeline Material: Galvani

Dimensions and Classifications

Overall Width (Imperial): 0.375 in

Overall Width (Metric): 9.525 mm

3M™ DBI-SALA® Lad-Saf™ Swaged Cable 6106065, 3/8 Inch, 7x19, Galvanized Steel, 65 FT

3M Product Number 6106065 3M ID 7100184443 UPC 00840779165841

Details

Robust cable tensioning and termination

Durable, high-strength steel construction that allows for maintenance-free longevity

Cable comes pre-cut and swaged, allowed for quick and easy installation and tensioning

Comes in stainless or galvanized steel, and in 1x7 or 7x19 versions

Typical properties

Brands: DBI-SALA®

Cable Preformation: Right. Regular Lay

Cable Strand: 7 x 19

Case Quantity: 1

Connected Safety ID Equipped: No

Install Type: Permanent

Lifeline Length (Imperial): 65 ft

Lifeline Length (Metric): 19.81 m

Lifeline Material: Galvaniz

Dimensions and Classifications

Overall Width (Imperial): 0.375 in

Overall Width (Metric): 9.525 mm

3M™ DBI-SALA® Lad-Saf™ Swaged Cable 6106070, 3/8 Inch, 7x19, Galvanized Steel, 70 FT

3M Product Number 6106070 3M ID 7100184444 UPC 00840779165858

Details

Robust cable tensioning and termination

Durable, high-strength steel construction that allows for maintenance-free longevity

Cable comes pre-cut and swaged, allowed for quick and easy installation and tensioning

Comes in stainless or galvanized steel, and in 1x7 or 7x19 versions

Typical properties

Anchor Connection Type: Swage

Brands: DBI-SALA®

Cable Preformation: Right. Regular Lay

Cable Strand: 7 x 19

Case Quantity: 1

Connected Safety ID Equipped: No

Install Type: Permanent

Lifeline Length (Imperial): 70 ft

Lifeline Length (Metric): 21.33

Dimensions and Classifications

Overall Width (Imperial): 0.375 in

Overall Width (Metric): 9.525 mm

3M™ DBI-SALA® Lad-Saf™ Swaged Cable 6106075, 3/8 Inch, 7x19, Galvanized Steel, 75 FT

3M Product Number 6106075 3M ID 7100184445 UPC 00840779165865

Details

Robust cable tensioning and termination

Durable, high-strength steel construction that allows for maintenance-free longevity

Cable comes pre-cut and swaged, allowed for quick and easy installation and tensioning

Comes in stainless or galvanized steel, and in 1x7 or 7x19 versions

Typical properties

Brands: DBI-SALA®

Cable Preformation: Right. Regular Lay

Cable Strand: 7 x 19

Case Quantity: 1

Connected Safety ID Equipped: No

Install Type: Permanent

Lifeline Length (Imperial): 75 ft

Lifeline Length (Metric): 22.86 m

Lifeline Material: Galvaniz

Dimensions and Classifications

Overall Width (Imperial): 0.375 in

Overall Width (Metric): 9.525 mm

3M™ DBI-SALA® Lad-Saf™ Swaged Cable 6106080, 3/8 Inch, 7x19, Galvanized Steel, 80 FT

3M Product Number 6106080 3M ID 7100184446 UPC 00840779165872

Details

Robust cable tensioning and termination

Durable, high-strength steel construction that allows for maintenance-free longevity

Cable comes pre-cut and swaged, allowed for quick and easy installation and tensioning

Comes in stainless or galvanized steel, and in 1x7 or 7x19 versions

Typical properties

Brands: DBI-SALA®

Cable Preformation: Right. Regular Lay

Cable Strand: 7 x 19

Case Quantity: 1

Connected Safety ID Equipped: No

Install Type: Permanent

Lifeline Length (Imperial): 80 ft

Lifeline Length (Metric): 24.38 m

Lifeline Material: Galvaniz

Dimensions and Classifications

Overall Width (Imperial): 0.375 in

Overall Width (Metric): 9.525 mm

3M™ DBI-SALA® Lad-Saf™ Swaged Cable 6106060, 3/8 Inch, 7x19, Galvanized Steel, 60 FT

3M Product Number 6106060 3M ID 7100184442 UPC 00840779165834

Details

Robust cable tensioning and termination

Durable, high-strength steel construction that allows for maintenance-free longevity

Cable comes pre-cut and swaged, allowed for quick and easy installation and tensioning

Comes in stainless or galvanized steel, and in 1x7 or 7x19 versions

Typical properties

Brands: DBI-SALA®

Cable Preformation: Right. Regular Lay

Cable Strand: 7 x 19

Case Quantity: 1

Connected Safety ID Equipped: No

Install Type: Permanent

Lifeline Length (Imperial): 60 ft

Lifeline Length (Metric): 18.28 m

Lifeline Material: Galvaniz

Dimensions and Classifications

Overall Width (Imperial): 0.375 in

Overall Width (Metric): 9.525 mm

3M™ DBI-SALA® Lad-Saf™ Swaged Cable 6106055, 3/8 Inch, 7x19, Galvanized Steel, 55 FT

3M Product Number 6106055 3M ID 7100184441 UPC 00840779165827

Details

Robust cable tensioning and termination

Durable, high-strength steel construction that allows for maintenance-free longevity

Cable comes pre-cut and swaged, allowed for quick and easy installation and tensioning

Comes in stainless or galvanized steel, and in 1x7 or 7x19 versions

Typical properties

Brands: DBI-SALA®

Cable Preformation: Right. Regular Lay

Cable Strand: 7 x 19

Case Quantity: 1

Connected Safety ID Equipped: No

Install Type: Permanent

Lifeline Length (Imperial): 55 ft

Lifeline Length (Metric): 16.76 m

Lifeline Material: Galvaniz

Dimensions and Classifications

Overall Width (Imperial): 0.375 in

Overall Width (Metric): 9.525 mm

3M™ DBI-SALA® Lad-Saf™ Swaged Cable 6106015, 3/8 Inch, 7x19, Galvanized Steel, 15 FT

3M Product Number 6106015 3M ID 7100184437 UPC 00840779165780

Details

Robust cable tensioning and termination

Durable, high-strength steel construction that allows for maintenance-free longevity

Cable comes pre-cut and swaged, allowed for quick and easy installation and tensioning

Comes in stainless or galvanized steel, and in 1x7 or 7x19 versions

Typical properties

Brands: DBI-SALA®

Cable Preformation: Right. Regular Lay

Cable Strand: 7 x 19

Case Quantity: 1

Connected Safety ID Equipped: No

Install Type: Permanent

Lifeline Length (Imperial): 15 ft

Lifeline Length (Metric): 4.57 m

Lifeline Material: Galvanize

Dimensions and Classifications

Overall Width (Imperial): 0.375 in

Overall Width (Metric): 9.525 mm

3M™ DBI-SALA® Lad-Saf™ Swaged Cable 6106025, 3/8 Inch, 7x19, Galvanized Steel, 25 FT

3M Product Number 6106025 3M ID 7100184438 UPC 00840779165797

Details

Robust cable tensioning and termination

Durable, high-strength steel construction that allows for maintenance-free longevity

Cable comes pre-cut and swaged, allowed for quick and easy installation and tensioning

Comes in stainless or galvanized steel, and in 1x7 or 7x19 versions

Typical properties

Brands: DBI-SALA®

Cable Preformation: Right. Regular Lay

Cable Strand: 7 x 19

Case Quantity: 1

Connected Safety ID Equipped: No

Install Type: Permanent

Lifeline Length (Imperial): 25 ft

Lifeline Length (Metric): 7.62 m

Lifeline Material: Galvanize

Dimensions and Classifications

Overall Width (Imperial): 0.375 in

Overall Width (Metric): 9.525 mm

3M™ DBI-SALA® Lad-Saf™ Swaged Cable 6106035, 3/8 Inch, 7x19, Galvanized Steel, 35 FT

3M Product Number 6106035 3M ID 7100184439 UPC 00840779165803

Details

Robust cable tensioning and termination

Durable, high-strength steel construction that allows for maintenance-free longevity

Cable comes pre-cut and swaged, allowed for quick and easy installation and tensioning

Comes in stainless or galvanized steel, and in 1x7 or 7x19 versions

Typical properties

Brands: DBI-SALA®

Cable Preformation: Right. Regular Lay

Cable Strand: 7 x 19

Case Quantity: 1

Connected Safety ID Equipped: No

Install Type: Permanent

Lifeline Length (Imperial): 35 ft

Lifeline Length (Metric): 10.66 m

Lifeline Material: Galvaniz

Dimensions and Classifications

Overall Width (Imperial): 0.375 in

Overall Width (Metric): 9.525 mm

3M™ DBI-SALA® Lad-Saf™ Swaged Cable 6105220, 3/8 Inch, 1x7, Stainless Steel, 220 FT

Part Number 6105220 3M Product Number 6105220 3M ID 7100184432

Details

Robust cable tensioning and termination

Durable, high-strength steel construction that allows for maintenance-free longevity

Cable comes pre-cut and swaged, allowed for quick and easy installation and tensioning

Comes in stainless or galvanized steel, and in 1x7 or 7x19 versions

Typical properties

Brands: DBI-SALA®

Cable Preformation: Left, Regular Lay

Cable Strand: 1 x 7

Case Quantity: 1

Connected Safety ID Equipped: No

Install Type: Permanent

Lifeline Length (Imperial): 220 ft

Lifeline Length (Metric): 67.05 m

Lifeline Material: Stainless

Dimensions and Classifications

Overall Width (Imperial): 0.375 in

Overall Width (Metric): 9.525 mm

3M™ DBI-SALA® Lad-Saf™ Swaged Cable 6105240, 3/8 Inch, 1x7, Stainless Steel, 240 FT

Part Number 6105240 3M Product Number 6105240 3M ID 7100184433

Details

Robust cable tensioning and termination
Durable, high-strength steel construction that allows for maintenance-free longevity
Cable comes pre-cut and swaged, allowed for quick and easy installation and tensioning
Comes in stainless or galvanized steel, and in 1x7 or 7x19 versions

Typical properties

Brands: DBI-SALA®
Cable Preformation: Left, Regular Lay
Cable Strand: 1 x 7
Case Quantity: 1
Connected Safety ID Equipped: No
Install Type: Permanent
Lifeline Length (Imperial): 240 ft
Lifeline Length (Metric): 73.15 m
Lifeline Material: Stainless

Dimensions and Classifications

Overall Width (Imperial): 0.375 in
Overall Width (Metric): 9.525 mm

3M™ DBI-SALA® Lad-Saf™ Swaged Cable 6105280, 3/8 Inch, 1x7, Stainless Steel, 280 FT

Part Number 6105280 3M Product Number 6105280 3M ID 7100184435

Details

Robust cable tensioning and termination

Durable, high-strength steel construction that allows for maintenance-free longevity

Cable comes pre-cut and swaged, allowed for quick and easy installation and tensioning

Comes in stainless or galvanized steel, and in 1x7 or 7x19 versions

Typical properties

Brands: DBI-SALA®

Cable Preformation: Left, Regular Lay

Cable Strand: 1 x 7

Case Quantity: 1

Connected Safety ID Equipped: No

Install Type: Permanent

Lifeline Length (Imperial): 280 ft

Lifeline Length (Metric): 85.34 m

Lifeline Material: Stainless

Dimensions and Classifications

Overall Width (Imperial): 0.375 in

Overall Width (Metric): 9.525 mm

3M™ DBI-SALA® Lad-Saf™ Swaged Cable 6105100, 3/8 Inch, 1x7, Stainless Steel, 100 FT

Part Number 6105100 3M Product Number 6105100 3M ID 7100184369

Details

Robust cable tensioning and termination

Durable, high-strength steel construction that allows for maintenance-free longevity

Cable comes pre-cut and swaged, allowed for quick and easy installation and tensioning

Comes in stainless or galvanized steel, and in 1x7 or 7x19 versions

Typical properties

Anchor Connection Type: Swage

Brands: DBI-SALA®

Cable Preformation: Left, Regular Lay

Cable Strand: 1 x 7

Case Quantity: 1

Connected Safety ID Equipped: No

Install Type: Permanent

Lifeline Length (Imperial): 100 ft

Lifeline Length (Metric): 30.48

Dimensions and Classifications

Overall Width (Imperial): 0.375 in

Overall Width (Metric): 9.525 mm

3M™ DBI-SALA® Lad-Saf™ Swaged Cable 6105060, 3/8 Inch, 1x7, Stainless Steel, 60 FT

Part Number 6105060 3M Product Number 6105060 3M ID 7100184365

Details

Robust cable tensioning and termination

Durable, high-strength steel construction that allows for maintenance-free longevity

Cable comes pre-cut and swaged, allowed for quick and easy installation and tensioning

Comes in stainless or galvanized steel, and in 1x7 or 7x19 versions

Typical properties

Anchor Connection Type: Swage

Brands: DBI-SALA®

Cable Preformation: Left, Regular Lay

Cable Strand: 1 x 7

Case Quantity: 1

Connected Safety ID Equipped: No

Install Type: Permanent

Lifeline Length (Imperial): 60 ft

Lifeline Length (Metric): 18.28 m

Dimensions and Classifications

Overall Width (Imperial): 0.375 in

Overall Width (Metric): 9.525 mm

3M™ DBI-SALA® Lad-Saf™ Swaged Cable 6107180, 3/8 Inch, 7x19, Stainless Steel, 180 FT

Part Number 6107180 3M Product Number 6107180 3M ID 7100184487

Details

Robust cable tensioning and termination

Durable, high-strength steel construction that allows for maintenance-free longevity

Cable comes pre-cut and swaged, allowed for quick and easy installation and tensioning

Comes in stainless or galvanized steel, and in 1x7 or 7x19 versions

Typical properties

Brands: DBI-SALA®

Cable Preformation: Right. Regular Lay

Cable Strand: 7 x 19

Case Quantity: 1

Connected Safety ID Equipped: No

Install Type: Permanent

Lifeline Length (Imperial): 180 ft

Lifeline Length (Metric): 54.86 m

Lifeline Material: Stainle

Dimensions and Classifications

Overall Width (Imperial): 0.375 in

Overall Width (Metric): 9.525 mm

3M™ DBI-SALA® Lad-Saf™ Swaged Cable 6105070, 3/8 Inch, 1x7, Stainless Steel, 70 FT

Part Number 6105070 3M Product Number 6105070 3M ID 7100184366

Details

Robust cable tensioning and termination
Durable, high-strength steel construction that allows for maintenance-free longevity
Cable comes pre-cut and swaged, allowed for quick and easy installation and tensioning
Comes in stainless or galvanized steel, and in 1x7 or 7x19 versions

Typical properties

Brands: DBI-SALA®
Cable Preformation: Left, Regular Lay
Cable Strand: 1 x 7
Case Quantity: 1
Connected Safety ID Equipped: No
Install Type: Permanent
Lifeline Length (Imperial): 70 ft
Lifeline Length (Metric): 21.33 m
Lifeline Material: Stainless

Dimensions and Classifications

Overall Width (Imperial): 0.375 in
Overall Width (Metric): 9.525 mm

3M™ DBI-SALA® Lad-Saf™ Swaged Cable 6107190, 3/8 Inch, 7x19, Stainless Steel, 190 FT

Part Number 6107190 3M Product Number 6107190 3M ID 7100184488

Details

Robust cable tensioning and termination

Durable, high-strength steel construction that allows for maintenance-free longevity

Cable comes pre-cut and swaged, allowed for quick and easy installation and tensioning

Comes in stainless or galvanized steel, and in 1x7 or 7x19 versions

Typical properties

Brands: DBI-SALA®

Cable Preformation: Right. Regular Lay

Cable Strand: 7 x 19

Case Quantity: 1

Connected Safety ID Equipped: No

Install Type: Permanent

Lifeline Length (Imperial): 190 ft

Lifeline Length (Metric): 57.91 m

Lifeline Material: Stainle

Dimensions and Classifications

Overall Width (Imperial): 0.375 in

Overall Width (Metric): 9.525 mm

3M™ DBI-SALA® Lad-Saf™ Swaged Cable 6107200, 3/8 Inch, 7x19, Stainless Steel, 200 FT

Part Number 6107200 3M Product Number 6107200 3M ID 7100184489

Details

Robust cable tensioning and termination

Durable, high-strength steel construction that allows for maintenance-free longevity

Cable comes pre-cut and swaged, allowed for quick and easy installation and tensioning

Comes in stainless or galvanized steel, and in 1x7 or 7x19 versions

Typical properties

Brands: DBI-SALA®

Cable Preformation: Right. Regular Lay

Cable Strand: 7 x 19

Case Quantity: 1

Connected Safety ID Equipped: No

Install Type: Permanent

Lifeline Length (Imperial): 200 ft

Lifeline Length (Metric): 60.96 m

Lifeline Material: Stainle

Dimensions and Classifications

Overall Width (Imperial): 0.375 in

Overall Width (Metric): 9.525 mm

3M™ DBI-SALA® Lad-Saf™ Swaged Cable 6105090, 3/8 Inch, 1x7, Stainless Steel, 90 FT

Part Number 6105090 3M Product Number 6105090 3M ID 7100184368

Details

Robust cable tensioning and termination
Durable, high-strength steel construction that allows for maintenance-free longevity
Cable comes pre-cut and swaged, allowed for quick and easy installation and tensioning
Comes in stainless or galvanized steel, and in 1x7 or 7x19 versions

Typical properties

Brands: DBI-SALA®
Cable Preformation: Left, Regular Lay
Cable Strand: 1 x 7
Case Quantity: 1
Connected Safety ID Equipped: No
Install Type: Permanent
Lifeline Length (Imperial): 90 ft
Lifeline Length (Metric): 27.43 m
Lifeline Material: Stainless

Dimensions and Classifications

Overall Width (Imperial): 0.375 in
Overall Width (Metric): 9.525 mm

3M™ DBI-SALA® Lad-Saf™ Swaged Cable 6107140, 3/8 Inch, 7x19, Stainless Steel, 140 FT

Part Number 6107140 3M Product Number 6107140 3M ID 7100184483

Details

Robust cable tensioning and termination

Durable, high-strength steel construction that allows for maintenance-free longevity

Cable comes pre-cut and swaged, allowed for quick and easy installation and tensioning

Comes in stainless or galvanized steel, and in 1x7 or 7x19 versions

Typical properties

Anchor Connection Type: Swage

Brands: DBI-SALA®

Cable Preformation: Right. Regular Lay

Cable Strand: 7 x 19

Case Quantity: 1

Connected Safety ID Equipped: No

Install Type: Permanent

Lifeline Length (Imperial): 140 ft

Lifeline Length (Metric): 42.6

Dimensions and Classifications

Overall Width (Imperial): 0.375 in

Overall Width (Metric): 9.525 mm

3M™ DBI-SALA® Lad-Saf™ Swaged Cable 6104100, 3/8 Inch, 1x7, Galvanized Steel, 100 FT

Part Number 6104100 3M Product Number 6104100 3M ID 7100184364

Details

Robust cable tensioning and termination

Durable, high-strength steel construction that allows for maintenance-free longevity

Cable comes pre-cut and swaged, allowed for quick and easy installation and tensioning

Comes in stainless or galvanized steel, and in 1x7 or 7x19 versions

Typical properties

Anchor Connection Type: Swage

Brands: DBI-SALA®

Cable Preformation: Left, Regular Lay

Cable Strand: 1 x 7

Case Quantity: 1

Connected Safety ID Equipped: No

Install Type: Permanent

Lifeline Length (Imperial): 100 ft

Lifeline Length (Metric): 30.48

Dimensions and Classifications

Overall Width (Imperial): 0.375 in

Overall Width (Metric): 9.525 mm

3M™ DBI-SALA® Lad-Saf™ Swaged Cable 6107170, 3/8 Inch, 7x19, Stainless Steel, 170 FT

Part Number 6107170 3M Product Number 6107170 3M ID 7100184486

Details

Robust cable tensioning and termination

Durable, high-strength steel construction that allows for maintenance-free longevity

Cable comes pre-cut and swaged, allowed for quick and easy installation and tensioning

Comes in stainless or galvanized steel, and in 1x7 or 7x19 versions

Typical properties

Anchor Connection Type: Swage

Brands: DBI-SALA®

Cable Preformation: Right. Regular Lay

Cable Strand: 7 x 19

Case Quantity: 1

Connected Safety ID Equipped: No

Install Type: Permanent

Lifeline Length (Imperial): 170 ft

Lifeline Length (Metric): 51.8

Dimensions and Classifications

Overall Width (Imperial): 3 in

3M™ DBI-SALA® Lad-Saf™ Swaged Cable 6107130, 3/8 Inch, 7x19, Stainless Steel, 130 FT

Part Number 6107130 3M Product Number 6107130 3M ID 7100184482

Details

Robust cable tensioning and termination

Durable, high-strength steel construction that allows for maintenance-free longevity

Cable comes pre-cut and swaged, allowed for quick and easy installation and tensioning

Comes in stainless or galvanized steel, and in 1x7 or 7x19 versions

Typical properties

Anchor Connection Type: Swage

Brands: DBI-SALA®

Cable Preformation: Right. Regular Lay

Cable Strand: 7 x 19

Case Quantity: 1

Connected Safety ID Equipped: No

Install Type: Permanent

Lifeline Length (Imperial): 130 ft

Lifeline Length (Metric): 39.6

Dimensions and Classifications

Overall Width (Imperial): 0.375 in

Overall Width (Metric): 9.525 mm

3M™ DBI-SALA® Lad-Saf™ Swaged Cable 6107040, 3/8 Inch, 7x19, Stainless Steel, 40 FT

Part Number 6107040 3M Product Number 6107040 3M ID 7100184358

Details

Robust cable tensioning and termination

Durable, high-strength steel construction that allows for maintenance-free longevity

Cable comes pre-cut and swaged, allowed for quick and easy installation and tensioning

Comes in stainless or galvanized steel, and in 1x7 or 7x19 versions

Typical properties

Anchor Connection Type: Swage

Brands: DBI-SALA®

Cable Preformation: Right. Regular Lay

Cable Strand: 7 x 19

Case Quantity: 1

Connected Safety ID Equipped: No

Install Type: Permanent

Lifeline Length (Imperial): 40 ft

Lifeline Length (Metric): 12.19

Dimensions and Classifications

Overall Width (Imperial): 0.375 in

Overall Width (Metric): 9.525 mm

3M™ DBI-SALA® Lad-Saf™ Swaged Cable 6107110, 3/8 Inch, 7x19, Stainless Steel, 110 FT

Part Number 6107110 3M Product Number 6107110 3M ID 7100184480

Details

Robust cable tensioning and termination

Durable, high-strength steel construction that allows for maintenance-free longevity

Cable comes pre-cut and swaged, allowed for quick and easy installation and tensioning

Comes in stainless or galvanized steel, and in 1x7 or 7x19 versions

Typical properties

Anchor Connection Type: Swage

Brands: DBI-SALA®

Cable Preformation: Right. Regular Lay

Cable Strand: 7 x 19

Case Quantity: 1

Connected Safety ID Equipped: No

Install Type: Permanent

Lifeline Length (Imperial): 110 ft

Lifeline Length (Metric): 33.5

Dimensions and Classifications

Overall Width (Imperial): 0.375 in

Overall Width (Metric): 9.525 mm

3M™ DBI-SALA® Lad-Saf™ Swaged Cable 6107120, 3/8 Inch, 7x19, Stainless Steel, 120 FT

Part Number 6107120 3M Product Number 6107120 3M ID 7100184481

Details

Robust cable tensioning and termination

Durable, high-strength steel construction that allows for maintenance-free longevity

Cable comes pre-cut and swaged, allowed for quick and easy installation and tensioning

Comes in stainless or galvanized steel, and in 1x7 or 7x19 versions

Typical properties

Brands: DBI-SALA®

Cable Preformation: Right. Regular Lay

Cable Strand: 7 x 19

Case Quantity: 1

Connected Safety ID Equipped: No

Install Type: Permanent

Lifeline Length (Imperial): 120 ft

Lifeline Length (Metric): 36.57 m

Lifeline Material: Stainle

Dimensions and Classifications

Overall Width (Imperial): 0.375 in

Overall Width (Metric): 9.525 mm

3M™ DBI-SALA® Lad-Saf™ Swaged Cable 6107085, 3/8 Inch, 7x19, Stainless Steel, 85 FT

Part Number 6107085 3M Product Number 6107085 3M ID 7100184476

Details

Robust cable tensioning and termination

Durable, high-strength steel construction that allows for maintenance-free longevity

Cable comes pre-cut and swaged, allowed for quick and easy installation and tensioning

Comes in stainless or galvanized steel, and in 1x7 or 7x19 versions

Typical properties

Anchor Connection Type: Swage

Brands: DBI-SALA®

Cable Preformation: Right. Regular Lay

Cable Strand: 7 x 19

Case Quantity: 1

Connected Safety ID Equipped: No

Install Type: Permanent

Lifeline Length (Imperial): 85 ft

Lifeline Length (Metric): 25.9

Dimensions and Classifications

Overall Width (Imperial): 0.375 in

Overall Width (Metric): 9.525 mm

3M™ DBI-SALA® Lad-Saf™ Swaged Cable 6107010, 3/8 Inch, 7x19, Stainless Steel, 10 FT

Part Number 6107010 3M Product Number 6107010 3M ID 7100184355

Details

Robust cable tensioning and termination

Durable, high-strength steel construction that allows for maintenance-free longevity

Cable comes pre-cut and swaged, allowed for quick and easy installation and tensioning

Comes in stainless or galvanized steel, and in 1x7 or 7x19 versions

Typical properties

Brands: DBI-SALA®

Cable Preformation: Right. Regular Lay

Cable Strand: 7 x 19

Case Quantity: 1

Connected Safety ID Equipped: No

Install Type: Permanent

Lifeline Length (Imperial): 10 ft

Lifeline Length (Metric): 3.04 m

Lifeline Material: Stainless

Dimensions and Classifications

Overall Width (Imperial): 0.375 in

Overall Width (Metric): 9.525 mm

3M™ DBI-SALA® Lad-Saf™ Swaged Cable 6107090, 3/8 Inch, 7x19, Stainless Steel, 90 FT

Part Number 6107090 3M Product Number 6107090 3M ID 7100184477

Details

Robust cable tensioning and termination

Durable, high-strength steel construction that allows for maintenance-free longevity

Cable comes pre-cut and swaged, allowed for quick and easy installation and tensioning

Comes in stainless or galvanized steel, and in 1x7 or 7x19 versions

Typical properties

Anchor Connection Type: Swage

Brands: DBI-SALA®

Cable Preformation: Right. Regular Lay

Cable Strand: 7 x 19

Case Quantity: 1

Connected Safety ID Equipped: No

Install Type: Permanent

Lifeline Length (Imperial): 90 ft

Lifeline Length (Metric): 27.43

Dimensions and Classifications

Overall Width (Imperial): 3 in

3M™ DBI-SALA® Lad-Saf™ Swaged Cable 6107020, 3/8 Inch, 7x19, Stainless Steel, 20 FT

Part Number 6107020 3M Product Number 6107020 3M ID 7100184356

Details

Robust cable tensioning and termination

Durable, high-strength steel construction that allows for maintenance-free longevity

Cable comes pre-cut and swaged, allowed for quick and easy installation and tensioning

Comes in stainless or galvanized steel, and in 1x7 or 7x19 versions

Typical properties

Brands: DBI-SALA®

Cable Preformation: Right. Regular Lay

Cable Strand: 7 x 19

Case Quantity: 1

Connected Safety ID Equipped: No

Install Type: Permanent

Lifeline Length (Imperial): 20 ft

Lifeline Length (Metric): 6.09 m

Lifeline Material: Stainless

Dimensions and Classifications

Overall Width (Imperial): 0.375 in

Overall Width (Metric): 9.525 mm

3M™ DBI-SALA® Lad-Saf™ Swaged Cable 6107100, 3/8 Inch, 7x19, Stainless Steel, 100 FT

Part Number 6107100 3M Product Number 6107100 3M ID 7100184479

Details

Robust cable tensioning and termination

Durable, high-strength steel construction that allows for maintenance-free longevity

Cable comes pre-cut and swaged, allowed for quick and easy installation and tensioning

Comes in stainless or galvanized steel, and in 1x7 or 7x19 versions

Typical properties

Anchor Connection Type: Swage

Brands: DBI-SALA®

Cable Preformation: Right. Regular Lay

Cable Strand: 7 x 19

Case Quantity: 1

Connected Safety ID Equipped: No

Install Type: Permanent

Lifeline Length (Imperial): 100 ft

Lifeline Length (Metric): 30.4

Dimensions and Classifications

Overall Width (Imperial): 0.375 in

Overall Width (Metric): 9.525 mm

3M™ DBI-SALA® Lad-Saf™ Swaged Cable 6107065, 3/8 Inch, 7x19, Stainless Steel, 65 FT

Part Number 6107065 3M Product Number 6107065 3M ID 7100184472

Details

Robust cable tensioning and termination

Durable, high-strength steel construction that allows for maintenance-free longevity

Cable comes pre-cut and swaged, allowed for quick and easy installation and tensioning

Comes in stainless or galvanized steel, and in 1x7 or 7x19 versions

Typical properties

Brands: DBI-SALA®

Cable Preformation: Right. Regular Lay

Cable Strand: 7 x 19

Case Quantity: 1

Connected Safety ID Equipped: No

Install Type: Permanent

Lifeline Length (Imperial): 65 ft

Lifeline Length (Metric): 19.81 m

Lifeline Material: Stainless

Dimensions and Classifications

Overall Width (Imperial): 0.375 in

Overall Width (Metric): 9.525 mm

3M™ DBI-SALA® Lad-Saf™ Swaged Cable 6106020, 3/8 Inch, 7x19, Galvanized Steel, 20 FT

3M Product Number 6106020 3M ID 7100184351 UPC 00840779152964

Details

Robust cable tensioning and termination

Durable, high-strength steel construction that allows for maintenance-free longevity

Cable comes pre-cut and swaged, allowed for quick and easy installation and tensioning

Comes in stainless or galvanized steel, and in 1x7 or 7x19 versions

Typical properties

Brands: DBI-SALA®

Cable Preformation: Right. Regular Lay

Cable Strand: 7 x 19

Case Quantity: 1

Connected Safety ID Equipped: No

Install Type: Permanent

Lifeline Length (Imperial): 20 ft

Lifeline Length (Metric): 6.09 m

Lifeline Material: Galvanize

Dimensions and Classifications

Overall Width (Imperial): 0.375 in

Overall Width (Metric): 9.525 mm

3M™ DBI-SALA® Lad-Saf™ Swaged Cable 6107070, 3/8 Inch, 7x19, Stainless Steel, 70 FT

Part Number 6107070 3M Product Number 6107070 3M ID 7100184473

Details

Robust cable tensioning and termination

Durable, high-strength steel construction that allows for maintenance-free longevity

Cable comes pre-cut and swaged, allowed for quick and easy installation and tensioning

Comes in stainless or galvanized steel, and in 1x7 or 7x19 versions

Typical properties

Brands: DBI-SALA®

Cable Preformation: Right. Regular Lay

Cable Strand: 7 x 19

Case Quantity: 1

Connected Safety ID Equipped: No

Install Type: Permanent

Lifeline Length (Imperial): 70 ft

Lifeline Length (Metric): 21.33 m

Lifeline Material: Stainles

Dimensions and Classifications

Overall Width (Imperial): 0.375 in

Overall Width (Metric): 9.525 mm

3M™ DBI-SALA® Lad-Saf™ Swaged Cable 6106030, 3/8 Inch, 7x19, Galvanized Steel, 30 FT

3M Product Number 6106030 3M ID 7100184352

Details

Robust cable tensioning and termination

Durable, high-strength steel construction that allows for maintenance-free longevity

Cable comes pre-cut and swaged, allowed for quick and easy installation and tensioning

Comes in stainless or galvanized steel, and in 1x7 or 7x19 versions

Typical properties

Brands: DBI-SALA®

Cable Preformation: Right. Regular Lay

Cable Strand: 7 x 19

Case Quantity: 1

Connected Safety ID Equipped: No

Install Type: Permanent

Lifeline Length (Imperial): 30 ft

Lifeline Length (Metric): 9.14 m

Lifeline Material: Galvanize

Dimensions and Classifications

Overall Width (Imperial): 0.375 in

Overall Width (Metric): 9.525 mm

3M™ DBI-SALA® Lad-Saf™ Swaged Cable 6107075, 3/8 Inch, 7x19, Stainless Steel, 75 FT

Part Number 6107075 3M Product Number 6107075 3M ID 7100184474

Details

Robust cable tensioning and termination

Durable, high-strength steel construction that allows for maintenance-free longevity

Cable comes pre-cut and swaged, allowed for quick and easy installation and tensioning

Comes in stainless or galvanized steel, and in 1x7 or 7x19 versions

Typical properties

Brands: DBI-SALA®

Cable Preformation: Right. Regular Lay

Cable Strand: 7 x 19

Case Quantity: 1

Connected Safety ID Equipped: No

Install Type: Permanent

Lifeline Length (Imperial): 75 ft

Lifeline Length (Metric): 22.86 m

Lifeline Material: Stainless

Dimensions and Classifications

Overall Width (Imperial): 0.375 in

Overall Width (Metric): 9.525 mm

3M™ DBI-SALA® Lad-Saf™ Swaged Cable 6106040, 3/8 Inch, 7x19, Galvanized Steel, 40 FT

3M Product Number 6106040 3M ID 7100184353 UPC 00840779152988

Details

Robust cable tensioning and termination

Durable, high-strength steel construction that allows for maintenance-free longevity

Cable comes pre-cut and swaged, allowed for quick and easy installation and tensioning

Comes in stainless or galvanized steel, and in 1x7 or 7x19 versions

Typical properties

Brands: DBI-SALA®

Cable Preformation: Right. Regular Lay

Cable Strand: 7 x 19

Case Quantity: 1

Connected Safety ID Equipped: No

Install Type: Permanent

Lifeline Length (Imperial): 40 ft

Lifeline Length (Metric): 12.19 m

Lifeline Material: Galvaniz

Dimensions and Classifications

Overall Width (Imperial): 0.375 in

Overall Width (Metric): 9.525 mm

3M™ DBI-SALA® Lad-Saf™ Swaged Cable 6107080, 3/8 Inch, 7x19, Stainless Steel, 80 FT

Part Number 6107080 3M Product Number 6107080 3M ID 7100184475

Details

Robust cable tensioning and termination

Durable, high-strength steel construction that allows for maintenance-free longevity

Cable comes pre-cut and swaged, allowed for quick and easy installation and tensioning

Comes in stainless or galvanized steel, and in 1x7 or 7x19 versions

Typical properties

Anchor Connection Type: Swage

Brands: DBI-SALA®

Cable Preformation: Right. Regular Lay

Cable Strand: 7 x 19

Case Quantity: 1

Connected Safety ID Equipped: No

Install Type: Permanent

Lifeline Length (Imperial): 80 ft

Lifeline Length (Metric): 24.38

Dimensions and Classifications

Overall Width (Imperial): 0.375 in

Overall Width (Metric): 9.525 mm

3M™ Speedglas™ 9100 FX-Air Welding Helmet 26-0099-35SW/37266(AAD), with SideWindows and Extended Headcover, No ADF, 1 EA/Case

3M Product Number 26-0099-35SW/37266(AAD) 3M ID 7100062095

Details

9100 FX-Air Headtop

No ADF Included

Side windows (shade 5) can help widen the field of vision

To be combined with 3M™ Adflo™ Powered air Respirator

Typical properties

ADF Dark State Shades: None

ADF Shade Range: None

Brands: Speedglas™

Case Quantity: 1

Headgear Type: Welding Helmet

Lens Type: No Lens

Product Color: Black

Product Series: 9100 FX-Air

Recommended Application: Assembly, Facility Maintenance, Grindi

3M™ DBI-SALA® Lad-Saf™ Swaged Cable 6107045, 3/8 Inch, 7x19, Stainless Steel, 45 FT

Part Number 6107045 3M Product Number 6107045 3M ID 7100184469

Details

Robust cable tensioning and termination

Durable, high-strength steel construction that allows for maintenance-free longevity

Cable comes pre-cut and swaged, allowed for quick and easy installation and tensioning

Comes in stainless or galvanized steel, and in 1x7 or 7x19 versions

Typical properties

Brands: DBI-SALA®

Cable Preformation: Right. Regular Lay

Cable Strand: 7 x 19

Case Quantity: 1

Connected Safety ID Equipped: No

Install Type: Permanent

Lifeline Length (Imperial): 45 ft

Lifeline Length (Metric): 13.71 m

Lifeline Material: Stainless

Dimensions and Classifications

Overall Width (Imperial): 0.375 in

Overall Width (Metric): 9.525 mm

3M™ DBI-SALA® Lad-Saf™ Swaged Cable 6105040, 3/8 Inch, 1x7, Stainless Steel, 40 FT

Part Number 6105040 3M Product Number 6105040 3M ID 7100184348

Details

Robust cable tensioning and termination

Durable, high-strength steel construction that allows for maintenance-free longevity

Cable comes pre-cut and swaged, allowed for quick and easy installation and tensioning

Comes in stainless or galvanized steel, and in 1x7 or 7x19 versions

Typical properties

Anchor Connection Type: Swage

Brands: DBI-SALA®

Cable Preformation: Left, Regular Lay

Cable Strand: 1 x 7

Case Quantity: 1

Connected Safety ID Equipped: No

Install Type: Permanent

Lifeline Length (Imperial): 40 ft

Lifeline Length (Metric): 12.19 m

Dimensions and Classifications

Overall Width (Imperial): 0.375 in

Overall Width (Metric): 9.525 mm

3M™ DBI-SALA® Lad-Saf™ Swaged Cable 6107055, 3/8 Inch, 7x19, Stainless Steel, 55 FT

Part Number 6107055 3M Product Number 6107055 3M ID 7100184470

Details

Robust cable tensioning and termination

Durable, high-strength steel construction that allows for maintenance-free longevity

Cable comes pre-cut and swaged, allowed for quick and easy installation and tensioning

Comes in stainless or galvanized steel, and in 1x7 or 7x19 versions

Typical properties

Brands: DBI-SALA®

Cable Preformation: Right. Regular Lay

Cable Strand: 7 x 19

Case Quantity: 1

Connected Safety ID Equipped: No

Install Type: Permanent

Lifeline Length (Imperial): 55 ft

Lifeline Length (Metric): 16.76 m

Lifeline Material: Stainles

Dimensions and Classifications

Overall Width (Imperial): 0.375 in

Overall Width (Metric): 9.525 mm

3M™ Speedglas™ 100 Series Welding Helmets

Details

Welding helmet with optional hard-hat adapter
Available Auto-Darkening Lens with five adjustable dark shades 8–12
Available Auto-Darkening Lens has three sensitivity settings for customized light-to-dark switching
Hard hat helps protect against falling objects
Applications include assembly, assembly and mechanical, facility maintenance, grinding, machine operations, metal repair, sanding, and welding

Typical properties

ADF Model: 100V, None
ADF Viewing Area (Metric): 44 mm x 93 mm
Battery Life: 1500 hours
Battery Type: CR2032
Case Quantity: 1
Comes with Auto-Darkening Filter (ADF): No, Yes
Features: Traditional Headgear
Front Panel Included: Yes
Graphic Theme: B

Dimensions and Classifications

ADF Viewing Area (Imperial): 1.7 in x 3.7 in

3M™ DBI-SALA® Lad-Saf™ Swaged Cable 6104040, 3/8 Inch, 1x7, Galvanized Steel, 40 FT

Part Number 6104040 3M Product Number 6104040 3M ID 7100184343

Details

Robust cable tensioning and termination

Durable, high-strength steel construction that allows for maintenance-free longevity

Cable comes pre-cut and swaged, allowed for quick and easy installation and tensioning

Comes in stainless or galvanized steel, and in 1x7 or 7x19 versions

Typical properties

Anchor Connection Type: Swage

Brands: DBI-SALA®

Cable Preformation: Left, Regular Lay

Cable Strand: 1 x 7

Case Quantity: 1

Connected Safety ID Equipped: No

Install Type: Permanent

Lifeline Length (Imperial): 40 ft

Lifeline Length (Metric): 12.19 m

Dimensions and Classifications

Overall Width (Imperial): 0.375 in

Overall Width (Metric): 9.525 mm

3M™ DBI-SALA® Lad-Saf™ Swaged Cable 6106300, 3/8 Inch, 7x19, Galvanized Steel, 300 FT

3M Product Number 6106300 3M ID 7100184465 UPC 00840779166060

Details

Robust cable tensioning and termination

Durable, high-strength steel construction that allows for maintenance-free longevity

Cable comes pre-cut and swaged, allowed for quick and easy installation and tensioning

Comes in stainless or galvanized steel, and in 1x7 or 7x19 versions

Typical properties

Brands: DBI-SALA®

Cable Preformation: Right. Regular Lay

Cable Strand: 7 x 19

Case Quantity: 1

Connected Safety ID Equipped: No

Install Type: Permanent

Lifeline Length (Imperial): 300 ft

Lifeline Length (Metric): 91.44 m

Lifeline Material: Galvani

Dimensions and Classifications

Overall Width (Imperial): 0.375 in

Overall Width (Metric): 9.525 mm

3M™ DBI-SALA® Lad-Saf™ Swaged Cable 6104050, 3/8 Inch, 1x7, Galvanized Steel, 50 FT

Part Number 6104050 3M Product Number 6104050 3M ID 7100184344

Details

Robust cable tensioning and termination

Durable, high-strength steel construction that allows for maintenance-free longevity

Cable comes pre-cut and swaged, allowed for quick and easy installation and tensioning

Comes in stainless or galvanized steel, and in 1x7 or 7x19 versions

Typical properties

Anchor Connection Type: Swage

Brands: DBI-SALA®

Cable Preformation: Left, Regular Lay

Cable Strand: 1 x 7

Case Quantity: 1

Connected Safety ID Equipped: No

Install Type: Permanent

Lifeline Length (Imperial): 50 ft

Lifeline Length (Metric): 15.24 m

Dimensions and Classifications

Overall Width (Imperial): 0.375 in

Overall Width (Metric): 9.525 mm

3M™ DBI-SALA® Lad-Saf™ Swaged Cable 6107015, 3/8 Inch, 7x19, Stainless Steel, 15 FT

Part Number 6107015 3M Product Number 6107015 3M ID 7100184466

Details

Robust cable tensioning and termination

Durable, high-strength steel construction that allows for maintenance-free longevity

Cable comes pre-cut and swaged, allowed for quick and easy installation and tensioning

Comes in stainless or galvanized steel, and in 1x7 or 7x19 versions

Typical properties

Brands: DBI-SALA®

Cable Preformation: Right. Regular Lay

Cable Strand: 7 x 19

Case Quantity: 1

Connected Safety ID Equipped: No

Install Type: Permanent

Lifeline Length (Imperial): 15 ft

Lifeline Length (Metric): 4.57 m

Lifeline Material: Stainless

Dimensions and Classifications

Overall Width (Imperial): 0.375 in

Overall Width (Metric): 9.525 mm

3M™ DBI-SALA® Lad-Saf™ Swaged Cable 6107025, 3/8 Inch, 7x19, Stainless Steel, 25 FT

Part Number 6107025 3M Product Number 6107025 3M ID 7100184467

Details

Robust cable tensioning and termination

Durable, high-strength steel construction that allows for maintenance-free longevity

Cable comes pre-cut and swaged, allowed for quick and easy installation and tensioning

Comes in stainless or galvanized steel, and in 1x7 or 7x19 versions

Typical properties

Brands: DBI-SALA®

Cable Preformation: Right. Regular Lay

Cable Strand: 7 x 19

Case Quantity: 1

Connected Safety ID Equipped: No

Install Type: Permanent

Lifeline Length (Imperial): 25 ft

Lifeline Length (Metric): 7.62 m

Lifeline Material: Stainless

Dimensions and Classifications

Overall Width (Imperial): 0.375 in

Overall Width (Metric): 9.525 mm

3M™ DBI-SALA® Lad-Saf™ Swaged Cable 6105020, 3/8 Inch, 1x7, Stainless Steel, 20 FT

Part Number 6105020 3M Product Number 6105020 3M ID 7100184346

Details

Robust cable tensioning and termination

Durable, high-strength steel construction that allows for maintenance-free longevity

Cable comes pre-cut and swaged, allowed for quick and easy installation and tensioning

Comes in stainless or galvanized steel, and in 1x7 or 7x19 versions

Typical properties

Anchor Connection Type: Swage

Brands: DBI-SALA®

Cable Preformation: Left, Regular Lay

Cable Strand: 1 x 7

Case Quantity: 1

Connected Safety ID Equipped: No

Install Type: Permanent

Lifeline Length (Imperial): 20 ft

Lifeline Length (Metric): 6.09 m

Dimensions and Classifications

Overall Width (Imperial): 0.375 in

Overall Width (Metric): 9.525 mm

3M™ DBI-SALA® Lad-Saf™ Swaged Cable 6107035, 3/8 Inch, 7x19, Stainless Steel, 35 FT

Part Number 6107035 3M Product Number 6107035 3M ID 7100184468

Details

Robust cable tensioning and termination

Durable, high-strength steel construction that allows for maintenance-free longevity

Cable comes pre-cut and swaged, allowed for quick and easy installation and tensioning

Comes in stainless or galvanized steel, and in 1x7 or 7x19 versions

Typical properties

Brands: DBI-SALA®

Cable Preformation: Right. Regular Lay

Cable Strand: 7 x 19

Case Quantity: 1

Connected Safety ID Equipped: No

Install Type: Permanent

Lifeline Length (Imperial): 35 ft

Lifeline Length (Metric): 10.66 m

Lifeline Material: Stainless

Dimensions and Classifications

Overall Width (Imperial): 0.375 in

Overall Width (Metric): 9.525 mm

3M™ DBI-SALA® Lad-Saf™ Swaged Cable 6104020, 3/8 Inch, 1x7, Galvanized Steel, 20 FT

Part Number 6104020 3M Product Number 6104020 3M ID 7100184341

Details

Robust cable tensioning and termination

Durable, high-strength steel construction that allows for maintenance-free longevity

Cable comes pre-cut and swaged, allowed for quick and easy installation and tensioning

Comes in stainless or galvanized steel, and in 1x7 or 7x19 versions

Typical properties

Brands: DBI-SALA®

Cable Preformation: Left, Regular Lay

Cable Strand: 1 x 7

Case Quantity: 1

Connected Safety ID Equipped: No

Install Type: Permanent

Lifeline Length (Imperial): 20 ft

Lifeline Length (Metric): 6.09 m

Lifeline Material: Galvanized

Dimensions and Classifications

Overall Width (Imperial): 0.375 in

Overall Width (Metric): 9.525 mm

3M™ DBI-SALA® Lad-Saf™ Swaged Cable 6106260, 3/8 Inch, 7x19, Galvanized Steel, 260 FT

3M Product Number 6106260 3M ID 7100184463 UPC 00840779166046

Details

Robust cable tensioning and termination

Durable, high-strength steel construction that allows for maintenance-free longevity

Cable comes pre-cut and swaged, allowed for quick and easy installation and tensioning

Comes in stainless or galvanized steel, and in 1x7 or 7x19 versions

Typical properties

Brands: DBI-SALA®

Cable Preformation: Right. Regular Lay

Cable Strand: 7 x 19

Case Quantity: 1

Connected Safety ID Equipped: No

Install Type: Permanent

Lifeline Length (Imperial): 260 ft

Lifeline Length (Metric): 79.24 m

Lifeline Material: Galvani

Dimensions and Classifications

Overall Width (Imperial): 3 in

3M™ DBI-SALA® Lad-Saf™ Swaged Cable 6104030, 3/8 Inch, 1x7, Galvanized Steel, 30 FT

Part Number 6104030 3M Product Number 6104030 3M ID 7100184342

Details

Robust cable tensioning and termination

Durable, high-strength steel construction that allows for maintenance-free longevity

Cable comes pre-cut and swaged, allowed for quick and easy installation and tensioning

Comes in stainless or galvanized steel, and in 1x7 or 7x19 versions

Typical properties

Anchor Connection Type: Swage

Brands: DBI-SALA®

Cable Preformation: Left, Regular Lay

Cable Strand: 1 x 7

Case Quantity: 1

Connected Safety ID Equipped: No

Install Type: Permanent

Lifeline Length (Imperial): 30 ft

Lifeline Length (Metric): 9.14 m

Dimensions and Classifications

Overall Width (Imperial): 0.375 in

Overall Width (Metric): 9.525 mm

3M™ DBI-SALA® Lad-Saf™ Swaged Cable 6106280, 3/8 Inch, 7x19, Galvanized Steel, 280 FT

3M Product Number 6106280 3M ID 7100184464 UPC 00840779166053

Details

Robust cable tensioning and termination

Durable, high-strength steel construction that allows for maintenance-free longevity

Cable comes pre-cut and swaged, allowed for quick and easy installation and tensioning

Comes in stainless or galvanized steel, and in 1x7 or 7x19 versions

Typical properties

Brands: DBI-SALA®

Cable Preformation: Right. Regular Lay

Cable Strand: 7 x 19

Case Quantity: 1

Connected Safety ID Equipped: No

Install Type: Permanent

Lifeline Length (Imperial): 280 ft

Lifeline Length (Metric): 85.34 m

Lifeline Material: Galvani

Dimensions and Classifications

Overall Width (Imperial): 0.375 in

Overall Width (Metric): 9.525 mm

3M™ DBI-SALA® Lad-Saf™ Swaged Cable 6104010, 3/8 Inch, 1x7, Galvanized Steel, 10 FT

Part Number 6104010 3M Product Number 6104010 3M ID 7100184340

Details

Robust cable tensioning and termination

Durable, high-strength steel construction that allows for maintenance-free longevity

Cable comes pre-cut and swaged, allowed for quick and easy installation and tensioning

Comes in stainless or galvanized steel, and in 1x7 or 7x19 versions

Typical properties

Brands: DBI-SALA®

Cable Preformation: Left, Regular Lay

Cable Strand: 1 x 7

Case Quantity: 1

Connected Safety ID Equipped: No

Install Type: Permanent

Lifeline Length (Imperial): 10 ft

Lifeline Length (Metric): 3.04 m

Lifeline Material: Galvanized

Dimensions and Classifications

Overall Width (Imperial): 0.375 in

Overall Width (Metric): 9.525 mm

3M™ DBI-SALA® Lad-Saf™ Swaged Cable 6106190, 3/8 Inch, 7x19, Galvanized Steel, 190 FT

3M Product Number 6106190 3M ID 7100184459 UPC 00840779166008

Details

Robust cable tensioning and termination

Durable, high-strength steel construction that allows for maintenance-free longevity

Cable comes pre-cut and swaged, allowed for quick and easy installation and tensioning

Comes in stainless or galvanized steel, and in 1x7 or 7x19 versions

Typical properties

Brands: DBI-SALA®

Cable Preformation: Right. Regular Lay

Cable Strand: 7 x 19

Case Quantity: 1

Connected Safety ID Equipped: No

Install Type: Permanent

Lifeline Length (Imperial): 190 ft

Lifeline Length (Metric): 57.91 m

Lifeline Material: Galvani

Dimensions and Classifications

Overall Width (Imperial): 3 in

3M™ DBI-SALA® Lad-Saf™ Swaged Cable 6106220, 3/8 Inch, 7x19, Galvanized Steel, 220 FT

3M Product Number 6106220 3M ID 7100184461 UPC 00840779166022

Details

Robust cable tensioning and termination

Durable, high-strength steel construction that allows for maintenance-free longevity

Cable comes pre-cut and swaged, allowed for quick and easy installation and tensioning

Comes in stainless or galvanized steel, and in 1x7 or 7x19 versions

Typical properties

Brands: DBI-SALA®

Cable Preformation: Right. Regular Lay

Cable Strand: 7 x 19

Case Quantity: 1

Connected Safety ID Equipped: No

Install Type: Permanent

Lifeline Length (Imperial): 220 ft

Lifeline Length (Metric): 67.05 m

Lifeline Material: Galvani

Dimensions and Classifications

Overall Width (Imperial): 3 in

3M™ DBI-SALA® Lad-Saf™ Swaged Cable 6106140, 3/8 Inch, 7x19, Galvanized Steel, 140 FT

Part Number 6106140 3M Product Number 6106140 3M ID 7100184454

Details

Robust cable tensioning and termination

Durable, high-strength steel construction that allows for maintenance-free longevity

Cable comes pre-cut and swaged, allowed for quick and easy installation and tensioning

Comes in stainless or galvanized steel, and in 1x7 or 7x19 versions

Typical properties

Brands: DBI-SALA®

Cable Preformation: Right. Regular Lay

Cable Strand: 7 x 19

Case Quantity: 1

Connected Safety ID Equipped: No

Install Type: Permanent

Lifeline Length (Imperial): 140 ft

Lifeline Length (Metric): 42.67 m

Lifeline Material: Galvani

Dimensions and Classifications

Overall Width (Imperial): 0.375 in

Overall Width (Metric): 9.525 mm

3M™ DBI-SALA® Lad-Saf™ Swaged Cable 6106150, 3/8 Inch, 7x19, Galvanized Steel, 150 FT

Part Number 6106150 3M Product Number 6106150 3M ID 7100184455

Details

Robust cable tensioning and termination

Durable, high-strength steel construction that allows for maintenance-free longevity

Cable comes pre-cut and swaged, allowed for quick and easy installation and tensioning

Comes in stainless or galvanized steel, and in 1x7 or 7x19 versions

Typical properties

Anchor Connection Type: Swage

Brands: DBI-SALA®

Cable Preformation: Right. Regular Lay

Cable Strand: 7 x 19

Case Quantity: 1

Connected Safety ID Equipped: No

Install Type: Permanent

Lifeline Length (Imperial): 150 ft

Lifeline Length (Metric): 45.7

Dimensions and Classifications

Overall Width (Imperial): 0.375 in

Overall Width (Metric): 9.525 mm

3M™ DBI-SALA® Lad-Saf™ Swaged Cable 6106160, 3/8 Inch, 7x19, Galvanized Steel, 160 FT

3M Product Number 6106160 3M ID 7100184456 UPC 00840779165971

Details

Robust cable tensioning and termination

Durable, high-strength steel construction that allows for maintenance-free longevity

Cable comes pre-cut and swaged, allowed for quick and easy installation and tensioning

Comes in stainless or galvanized steel, and in 1x7 or 7x19 versions

Typical properties

Brands: DBI-SALA®

Cable Preformation: Right. Regular Lay

Cable Strand: 7 x 19

Case Quantity: 1

Connected Safety ID Equipped: No

Install Type: Permanent

Lifeline Length (Imperial): 160 ft

Lifeline Length (Metric): 48.76 m

Lifeline Material: Galvani

Dimensions and Classifications

Overall Width (Imperial): 0.375 in

Overall Width (Metric): 9.525 mm

3M™ DBI-SALA® Lad-Saf™ Swaged Cable 6106170, 3/8 Inch, 7x19, Galvanized Steel, 170 FT

3M Product Number 6106170 3M ID 7100184457 UPC 00840779165988

Details

Robust cable tensioning and termination

Durable, high-strength steel construction that allows for maintenance-free longevity

Cable comes pre-cut and swaged, allowed for quick and easy installation and tensioning

Comes in stainless or galvanized steel, and in 1x7 or 7x19 versions

Typical properties

Brands: DBI-SALA®

Cable Preformation: Right. Regular Lay

Cable Strand: 7 x 19

Case Quantity: 1

Connected Safety ID Equipped: No

Install Type: Permanent

Lifeline Length (Imperial): 170 ft

Lifeline Length (Metric): 51.81 m

Lifeline Material: Galvani

Dimensions and Classifications

Overall Width (Imperial): 0.375 in

Overall Width (Metric): 9.525 mm

3M™ DBI-SALA® Lad-Saf™ Swaged Cable 6106120, 3/8 Inch, 7x19, Galvanized Steel, 120 FT

3M Product Number 6106120 3M ID 7100184452 UPC 00840779165933

Details

Robust cable tensioning and termination

Durable, high-strength steel construction that allows for maintenance-free longevity

Cable comes pre-cut and swaged, allowed for quick and easy installation and tensioning

Comes in stainless or galvanized steel, and in 1x7 or 7x19 versions

Typical properties

Brands: DBI-SALA®

Cable Preformation: Right. Regular Lay

Cable Strand: 7 x 19

Case Quantity: 1

Connected Safety ID Equipped: No

Install Type: Permanent

Lifeline Length (Imperial): 120 ft

Lifeline Length (Metric): 36.57 m

Lifeline Material: Galvani

Dimensions and Classifications

Overall Width (Imperial): 0.375 in

Overall Width (Metric): 9.525 mm

3M™ DBI-SALA® Lad-Saf™ Swaged Cable 6106130, 3/8 Inch, 7x19, Galvanized Steel, 130 FT

3M Product Number 6106130 3M ID 7100184453 UPC 00840779165940

Details

Robust cable tensioning and termination

Durable, high-strength steel construction that allows for maintenance-free longevity

Cable comes pre-cut and swaged, allowed for quick and easy installation and tensioning

Comes in stainless or galvanized steel, and in 1x7 or 7x19 versions

Typical properties

Brands: DBI-SALA®

Cable Preformation: Right. Regular Lay

Cable Strand: 7 x 19

Case Quantity: 1

Connected Safety ID Equipped: No

Install Type: Permanent

Lifeline Length (Imperial): 130 ft

Lifeline Length (Metric): 39.62 m

Lifeline Material: Galvani

Dimensions and Classifications

Overall Width (Imperial): 0.375 in

Overall Width (Metric): 9.525 mm

3M™ DBI-SALA® Lad-Saf™ Swaged Cable 6106110, 3/8 Inch, 7x19, Galvanized Steel, 110 FT

3M Product Number 6106110 3M ID 7100184451 UPC 00840779165926

Details

Robust cable tensioning and termination

Durable, high-strength steel construction that allows for maintenance-free longevity

Cable comes pre-cut and swaged, allowed for quick and easy installation and tensioning

Comes in stainless or galvanized steel, and in 1x7 or 7x19 versions

Typical properties

Brands: DBI-SALA®

Cable Preformation: Right. Regular Lay

Cable Strand: 7 x 19

Case Quantity: 1

Connected Safety ID Equipped: No

Install Type: Permanent

Lifeline Length (Imperial): 110 ft

Lifeline Length (Metric): 33.52 m

Lifeline Material: Galvani

Dimensions and Classifications

Overall Width (Imperial): 0.375 in

Overall Width (Metric): 9.525 mm

3M™ SecureFit™ 300 Series Safety Glasses

Details

3M's innovative temple design features slotted ribs that provide comfortable pressure equalization, allowing the temples to flex and self-adjust to the size of the wearer's head

Curved temples apply pressure to the less sensitive back of the head, instead of the temples, achieving a comfortable fit even during rapid head movement

Lenses are angled to help accommodate high cheekbone structure

Soft nose pads help safety eyewear fit securely on a low nose bridge

Choose from models with anti-fog/anti-scratch or 3M™ Scotchgard™ Anti-Fog coating

U6 rated polycarbonate lenses absorb 99.9% of UVA, UVB, and UVC rays between 200 nm and 380 nm

Workers can feel confident wearing 3M eye protection that meets the Impact-Rated Protector requirement of the ANSI-ISEA Z87.1 Standard

Typical properties

ANSI Requirements: ANSI Z87.1-2003

Anti Fog Lens: Yes

Case Quantity: 20

Class: Premium, Value

Comfort Features: 3M™ Pressure Diffusion Temple Technology, Comfortable Wraparound Frame, Integrated sideshields, Lens angle adjustment, Lightweight, Polycar

3M™ PELTOR™ SwatTac V Headset MT20H682FB-47 SV, Foldable, Single Lead, Standard Dynamic Mic, NATO Wiring, Black, 10 ea/Case

3M Product Number MT20H682FB-47 SV 3M ID 7100223432 UPC 00076308945978

Details

Level Dependant, Electronic Hearing Protection to Help Protect from Impulse and Steady State Noise

Rugged 3M™ PELTOR™ Design for Trusted Performance

EarPlug Mode for high noise environments

Omni Directional Environmental Microphones for Level Dependant Hearing protection and Auditory Situational Awareness

Typical properties

Attenuation Rating: 23 dB

Audio Type: Communication

Battery Life: 150 Hours

Brands: PELTOR™

Case Quantity: 1

Communication Direction: Two-way

Communication Type: Tactical

Connection Type: Wired

Features: Compatible with Most Helmets, Dynamic Diffe

3M™ PELTOR™ SwatTac V Hearing Defender Headset MT20H682BB-09 SV, Neckband, Black, 10 ea/Case

3M Product Number MT20H682BB-09 SV 3M ID 7100223429 UPC 00076308946005

Details

Level Dependant, Electronic Hearing Protection to Help Protect from Impulse and Steady State Noise

Rugged 3M™ PELTOR™ Design for Trusted Performance

Omni Directional Environmental Microphones for Level Dependant Hearing protection and Auditory Situational Awareness

Typical properties

Attenuation Rating: 23 dB, 22 dB

Audio Type: Communication

Battery Life: 150 Hours

Brands: PELTOR™

Case Quantity: 1

Communication Direction: Two-way

Communication Type: Tactical

Connection Type: Wired

Features: Compatible with Most Helmets, Dynamic

3M™ PELTOR™ SwatTac V Hearing Defender Headset MT20H682FB-09 SV, Foldable, Black, 10 ea/Case

3M Product Number MT20H682FB-09 SV 3M ID 7100223426 UPC 00076308946036

Details

Level Dependant, Electronic Hearing Protection to Help Protect from Impulse and Steady State Noise

Rugged 3M™ PELTOR™ Design for Trusted Performance

Omni Directional Environmental Microphones for Level Dependant Hearing protection and Auditory Situational Awareness

Typical properties

Attenuation Rating: 23 dB

Audio Type: Communication

Battery Life: 150 Hours

Brands: PELTOR™

Case Quantity: 1

Communication Direction: Two-way

Communication Type: Tactical

Connection Type: Wired

Features: Compatible with Most Helmets, Dynamic Diffe

3M™ PELTOR™ SwatTac V Headset MT20H682BB-19 SV, Neckband, Dual Lead, Standard Dynamic Mic, NATO Wiring, Black, 10 ea/Case

3M Product Number MT20H682BB-19 SV 3M ID 7100223439 UPC 00076308945886

Details

Level Dependant, Electronic Hearing Protection to Help Protect from Impulse and Steady State Noise

Rugged 3M™ PELTOR™ Design for Trusted Performance

EarPlug Mode for high noise environments

Omni Directional Environmental Microphones for Level Dependant Hearing protection and Auditory Situational Awareness

Typical properties

Attenuation Rating: 23 dB, 22 dB

Audio Type: Communication

Battery Life: 150 Hours

Brands: PELTOR™

Case Quantity: 1

Communication Direction: Two-way

Communication Type: Tactical

Connection Type: Wired

Features: Compatible with Most Helmets, Dynamic

3M™ PELTOR™ SwatTac V Headset MT20H682FB-19 SV, Foldable, Dual Lead, Standard Dynamic Mic, NATO Wiring, Black, 10 ea/Case

3M Product Number MT20H682FB-19 SV 3M ID 7100223425 UPC 00076308945916

Details

Level Dependant, Electronic Hearing Protection to Help Protect from Impulse and Steady State Noise

Rugged 3M™ PELTOR™ Design for Trusted Performance

EarPlug Mode for high noise environments

Omni Directional Environmental Microphones for Level Dependant Hearing protection and Auditory Situational Awareness

Typical properties

Attenuation Rating: 23 dB

Audio Type: Communication

Battery Life: 150 Hours

Brands: PELTOR™

Case Quantity: 1

Communication Direction: Two-way

Communication Type: Tactical

Connection Type: Wired

Features: Compatible with Most Helmets, Dynamic Diffe

3M™ PELTOR™ SwatTac V Headset MT20H682BB-47 SV, Neckband, Single Lead, Standard Dynamic Mic, NATO Wiring, Black, 10 ea/Case

3M Product Number MT20H682BB-47 SV 3M ID 7100223422 UPC 00076308945947

Details

Level Dependant, Electronic Hearing Protection to Help Protect from Impulse and Steady State Noise

Rugged 3M™ PELTOR™ Design for Trusted Performance

EarPlug Mode for high noise environments

Omni Directional Environmental Microphones for Level Dependant Hearing protection and Auditory Situational Awareness

Typical properties

Attenuation Rating: 23 dB,22 dB

Audio Type: Communication

Battery Life: 150 Hours

Brands: PELTOR™

Case Quantity: 1

Communication Direction: Two-way

Communication Type: Tactical

Connection Type: Wired

Features: Compatible with Most Helmets, Dynamic

3M™ DBI-SALA® Permanent Roof Anchor

Details

Durable materials and hardware designed to help stand up to harsh working conditions
Compatible with various fall arrest systems, not compliant for use with Horizontal Lifelines
Suitable for use in general industrial and construction industries
Compact, lightweight design
Meets the requirements for 29 CFR OSHA 1910.140 and 29 CFR OSHA 1926.502
Features corrosion-resistant, steel and aluminum construction for durability
This safety equipment is designed for use with additional personal protective equipment (PPE)
Includes permanent or detachable options and reusable D-ring assembly
Installs onto various sizes of wood-framed structures
Designed to fit multiple size trusses with bolt and clamp installation
Integral stainless steel D-ring tie-off point

Typical properties

Anchor Install Type: Permanent
Attachment Type: Bolt/Clamp
Case Quantity: 1
Connected Safety ID Equipped: No
Dimensions:
3.00x0.40x17.80in,3.60x3.20x17.80in,3.00x0.40x13.90in,3.60x3.20x9.80in,3.60x3.20x13.70in
Install Type: Permanent, Semi-Reusable

3M™ DBI-SALA® Toggle Bolt Fastener Kit For Roof Top Anchor 7241182, 150 mm, 4 ea/Pack

Part Number 7241182 3M Product Number 7241182 3M ID 7100241077

Details

Variable lengths available 6 in., 12 in., and 20 in. (15 cm, 30.5 cm, and 50 cm)
Fastener kit for use with roof top anchor
Suitable for flat roofs on trapezoidal and plywood deck, hollow concrete structures, or membrane and built-up roof decks
Corrosion resistant construction
User friendly compact and lightweight design
Compatible with various fall arrest systems
Recommended for use in multiple industries including construction, oil and gas, and utilities

Typical properties

Anchor Install Type: Permanent
Anchor Type: Roofing
Brands: DBI-SALA®
Case Quantity: 1
Connected Safety ID Equipped: No
For Use With: Roof Top Anchor
Install Type: Reusable
Material: Zinc Plated Steel
Net Weight (Imperial): 1.8 lb
Net Weight (Met

Dimensions and Classifications

Overall Length (Imperial): 6 in

3M™ DBI-SALA® Toggle Bolt Fastener Kit For Roof Top Anchor 7241183, 300 mm, 4 ea/Pack

Part Number 7241183 3M Product Number 7241183 3M ID 7100241078

Details

Variable lengths available 6 in., 12 in., and 20 in. (15 cm, 30.5 cm, and 50 cm)
Fastener kit for use with roof top anchor
Suitable for flat roofs on trapezoidal and plywood deck, hollow concrete structures, or membrane and built-up roof decks
Corrosion resistant construction
User friendly compact and lightweight design
Compatible with various fall arrest systems
Recommended for use in multiple industries including construction, oil and gas, and utilities

Typical properties

Anchor Install Type: Permanent
Anchor Type: Roofing
Brands: DBI-SALA®
Case Quantity: 1
Connected Safety ID Equipped: No
For Use With: Roof Top Anchor
Install Type: Reusable
Material: Zinc Plated Steel
Net Weight (Imperial): 2.2 lb
Net Weight (Met

Dimensions and Classifications

Overall Length (Imperial): 12 in

3M™ DBI-SALA® Reusable Compact Roof Anchor For Wood 2104196, with Fastener Kit

Part Number 2104196 3M Product Number 2104196 3M ID 7012818309

Details

Durable materials and hardware designed to help stand up to harsh working conditions
Compatible with various fall arrest systems, not compliant for use with Horizontal Lifelines
Suitable for use in general industrial and construction industries
Compact, lightweight design
Meets the requirements for 29 CFR OSHA 1910.140 and 29 CFR OSHA 1926.502
Features corrosion-resistant, steel and aluminum construction for durability
This safety equipment is designed for use with additional personal protective equipment (PPE)
Installs to sloped or flat wood roofs
Includes 3 ea. lag screws for fast and easy installation
Built-in D-ring tie-off point
Portable and reusable

Typical properties

Anchor Install Type: Reusable
Attachment Type: Screw
Brands: DBI-SALA®
Connected Safety ID Equipped: No
Install Type: Reusable
Material: Zinc Plated Steel
Product Color: Black
Product Type: Reusable Compact Roof Anchor
Recommended Industry: Constr

3M™ DBI-SALA® Confined Space 5-Piece Davit Hoist System

Details

- Integrated 5,000 lb. (22 kN) mast anchorage point
- Fall arrest rated in all davit offset mast positions
- Adjustable mast height and base width
- Durable aluminum construction
- Adjustable foot-leveling system
- Available in two extension ranges: 11.5 in. to 27.5 in. (29.2 cm to 69.8 cm), and 23.5 in. to 42.5 in. (59.7 cm to 108 cm)
- Recommended for use in many industries
- Built-in level indicator
- Easy to set-up and dismantle without tools

Typical properties

- Case Quantity: 1
- Connected Safety ID Equipped: No
- Install Type: Portable
- Net Weight (Imperial): 164.7 lb
- Net Weight (Metric): 74.7 kg
- Package Contents: 1 Long Reach Adjustable Offset Upper Mast, 1 Lower Mast, 3-piece Base, 1 Short Reach Adjustable Off

Dimensions and Classifications

- Overall Height (Imperial): 100.26 in, 112.75 in
- Overall Height (Metric): 254.66 cm, 286.36 cm

3M™ DBI-SALA® Temporary Horizontal Lifeline System For Vacuum Anchor System 2200400, Kernmantle Rope, 40 ft

Part Number 2200400 3M Product Number 2200400 3M ID 7100235923

Details

Designed for use with our DBI-SALA™ Vacuum Anchor Lifeline System (sold separately)

Resilient materials stand up to harsh conditions

Allows for 2 workers per span

Horizontal lifeline systems offer workers exceptional range of motion on the job

This safety equipment is intended for use with additional personal protective equipment (PPE)

Recommended for use in multiple industries including construction, aeronautics, railroad, facilities, power plants, and more

Meets OSHA 1926.502 and OSHA 1910.140 requirements

Typical properties

Brands: DBI-SALA®

Case Quantity: 1

Connected Safety ID Equipped: Yes

Features: For Vacuum Anchor

For Use With: Mobi-Lok™

Install Type: Temporary/Portable

Lifeline Hook Material: Forged Steel

Lifeline Length (Imperial): 40 ft

Lifeline Length (Metric)

Dimensions and Classifications

Overall Length (Imperial): 40 ft

Overall Length (Metric): 12.2 m

3M™ PELTOR™ LiteCom Pro II Li-Ion Intrinsically Safe Battery ACK08-50, 1 EA/Case

3M Product Number ACK08-50 3M ID 7000108520 UPC 07318640063037

Details

Rechargeable Lithium-Ion Battery Pack
For use with the 3M™ PELTOR™ LiteCom Pro II Headsets
1 each/case

Typical properties

Battery Life: 14 - 17 Hours
Battery Type: Rechargeable Li-ion Pack
Brands: PELTOR™
Intrinsically Safe: Yes
Product Color: Black
Product Type: Battery
Purpose: Exclude
Specifications Met: Certified Intrinsically Safe by Factory Mutual (FM)
eClass 1

3M™ Disposable Protective Coverall 4540

Details

Two-way zipper with sealable storm flap helps provide additional protection against contaminants

Anti-static treatment on both sides can help reduce static build-up

Reinforced gusset between the legs helps provide increased durability while bending and squatting

Seamless shoulders and sleeve tops offer extra strength and protection

Extra-roomy design in arms and legs deliver enhanced mobility

Recommended for liquid pesticide application, pharmaceutical powder handling, powder coating, spray painting, spray coating, and more

20 or 25 units are included in each case

Typical properties

Closure Method: Two-way Zipper

Coverall Style: Collared, Hooded

Features: 3 Panel Hood, Anti-static, Collar (No Hood), Elastic Waist & Ankle, Knitted Cuff, Radioactive Particulate Protection

Hazard Type: Dust, Light Liquid splash, Particulate Material

3M™ Filter/Adapter/Retainer Kit 6N01, N95, 1 Kit/Case

3M Product Number 6N01 3M ID 7100234543 UPC 00638060431412

Details

Kit includes 20 pairs (40 eaches) 3M™ 5N11 Particulate Filters, N95 (enough for up to 10 individual users and 1 filter pair change out)

Kit includes 10 pairs (20 eaches) 3M™ 501 Filter Retainers (enough for up to 10 individual users), may be reused multiple times and wiped down

Kit includes 10 pairs (20 eaches) 3M™ 603 Filter Adapters (enough for up to 10 individual users), may be reused multiple times and wiped down

Use 3M™ Particulate Filter 5N11 with 3M™ 603 Filter Adapter and 3M™ 501 Filter Retainer

3M™ 603 Filter Adapter and 3M™ 501 Filter Retainer may also be used with 3M™ 5P71 prefilter

3M™ 603 Filter Adapters has a bayonet attachment and may be used with 3M™ 6000, 7000 and FF-400 series reusable respirator facepieces or 3M™ Scott™ AV-3000 HT and AV-3000 SureSeal facepieces with the 3M™ Scott™ AV-632 Bayonet Adapter

3M™ 501 Filter Retainer holds 3M™ Particulate Filters 5N11 or 5P71/07194 (AAD) in place on top of 3M™ 6000 Cartridge Series or 3M™ 603 Filter Adapter

All respirators, replacement filters, cartridges, and adapters sold separately

Refer to the Filter/Cartridge User Instructions for further information

Typical properties

Accessories: No

Brands: 3M™

Clip-on Welding Shield: No

Compatible with 3M™ PAPR Systems: No

Compatible with 3M™ Supplied Air System: No

Compatible with Welding Shield: No

Cool Flow™ Exhalation Valve: No

Drop-down Feature: No

Enhanced Comfort: No

3M™ DBI-SALA® FlexiGuard™ M100 Portable Counterweight Base

Details

- Powder coated steel upright and gusset components
- Extended rail-length increases safe working area compared to our previous jib systems
- Extended anchor height enhances capabilities in various applications compared to our previous jib systems
- Automatic mast lock helps prevent uncontrolled mast movement
- Aluminum extruded trolley rail with stainless steel / nylon trolley construction
- Rotating mast up to 360 degrees with Flip up rotation handle
- Permanent and portable mounted designs available
- Power assisted height adjustment capability for adjustable models
- Leveling jacks standard on the M100 with integrated fork pockets for transporting and positioning using industrial forklifts
- 3M™ Safety-Walk™ Slip Resistant walking surface (counterweight Bases)
- Additional system mobility with optional caster wheel kit

Typical properties

- Concrete Included: No, Yes
- Connected Safety ID Equipped: No
- Install Type: Temporary/Portable
- Manufacturing Origin: USA
- Maximum Height (Imperial): 4.5 ft
- Maximum Height (Metric): 1.4 m
- Maximum Number of Users: One
- Minimum Height (Imperial): 4.5 ft

Dimensions and Classifications

- Overall Height (Metric): 0 mm, 1680 mm
- Overall Length (Metric): 1390 mm, 1680 mm
- Overall Width (Metric): 142 mm, 203 mm

3M™ Sensitivity Solution

Details

Available in either sweet or a bitter taste fit test solution for fit testing
Used with the 3M™ Qualitative Fit Test Apparatus FT-10, FT-20 and/or FT-30
For Occupational Use Only

Typical properties

Case Quantity: 6
Clinical Area: Surgery
Product Type: Sensitivity Solution
Purpose: Parts and Accessories
Recommended Application: Fit Testing
Solution Type: Bitter, Sweet
Specifications Met: CE Approved
Test Format: Qualitative
eClass 14 Classifi

3M™ PELTOR™ Left Side Boom Harness FL6AR 1 EA/Case

3M Product Number FL6AR 3M ID 7000141071 UPC 04046719411337

Details

Boom harness for mounting a boom microphone to the right earcup

Typical properties

Brands: PELTOR™

Intrinsically Safe: No

Product Color: Black

Product Type: Cable

Purpose: Exclude

eClass 14 Classification Group: 40270191

3M™ PELTOR™ Left Side Boom Harness, NATO Wiring, FL6AF, 10 EA/Case

3M Product Number FL6AF 3M ID 7000141070 UPC 07318640037953

Details

Boom harness for mounting a boom microphone to the left earcup
Applicable for both ComTac and ComTac II series headsets
Left or right cup microphone placement
NATO wiring set up

Typical properties

Brands: PELTOR™
Intrinsically Safe: No
Product Color: Black
Product Type: Cable
Purpose: Military/Police
eClass 14 Classification Group: 40270191

3M™ Hard Hat Vented Cap Style with Pin-Lock Adjustment, Yellow, 1 Ea/Pk

3M ID 70007082889 UPC 00051131226722

Details

3M™ Vented Hard Hat with Pin Lock Adjustment is worn to help protect the head from possible top impact
Suspension sits low on the head to increase comfort and security
Vented design allows for more airflow
Padded sweatband for comfort
Can be worn in reverse position for increased upward visibility
Provides personalized fit with 3 levels of height adjustment
Adjustable pin-lock for easy off-head sizing adjustments
Cap style hard hat is ANSI compliant when worn forward or reverse
Meets ANSI Z89.1 Type I Class C requirements
Made in USA with globally sourced materials

Typical properties

Brands: 3M™
Factory ISO Certification: No ISO Certification information available
eClass 14 Classification Group: 40300202

3M™ Hard Hat Vented Cap Style with Pin-Lock Adjustment, White, 1 Ea/Pk

3M ID 70007082871 UPC 00051131226715

Details

- 3M™ Vented Hard Hat with Pin Lock Adjustment is worn to help protect the head from possible top impact
- Suspension sits low on the head to increase comfort and security
- Vented design allows for more airflow
- Padded sweatband for comfort
- Can be worn in reverse position for increased upward visibility
- Provides personalized fit with 3 levels of height adjustment
- Adjustable pin-lock for easy off-head sizing adjustments
- Cap style hard hat is ANSI compliant when worn forward or reverse
- Meets ANSI Z89.1 Type I Class C requirements
- Made in USA with globally sourced materials

Typical properties

- Brands: 3M™
- Factory ISO Certification: No ISO Certification information available
- eClass 14 Classification Group: 40300202

3M™ 60923 Performance Cartridge for Multi-Purpose Respirator

3M ID 70006983319 UPC 00051141900223

Details

NIOSH-APPROVED OV/AG/P100 RATING filters at least 99.97% of solids and liquid aerosols, as well as oil-based particulates

FOR WORKPLACE/OCCUPATIONAL USE ONLY

OIL PROOF (Use according to manufacturer's time use restrictions when oil aerosols are present)

HELPS REDUCE EXPOSURE to certain organic vapors encountered during activities involving latex and oil-based painting, including paint spraying, varnishes, stains, sealants, solvents, certain solvent-based cleaners or pesticides*

ALSO HELPS REDUCE EXPOSURE against certain acid gases such as heavy-duty cleaners/bleach, sealants and pool chemicals/treatments

*Refer to Pesticide Product Label for Respirator Guidance or call 3M at 1-800-243-4630 or In Canada, call 1-800-267-4414

Use this product in accordance with all applicable respiratory protection requirements including OSHA Lead Standard and US-EPA Guidelines for mold
EASY-TO-ATTACH DESIGN

Cartridge Color: magenta and yellow

APPROVED FOR use with 3M™ 6000, 6500 and 7500 facepieces

WARNING: Workplace/Occupational Applications: This respirator helps protect against certain airborne contaminants. Misuse may result in sickness or death.

For correct use, consult supervisor and User Instructions, or call 3M in USA at 1-800-243-4630. In Canada, call 1-800-267-4414

Typical properties

Brands: 3M™

Cartridge or Filter Included: Yes

Cartridge or Filter Type: Combination

Case Quantity: 5 Packs/Case

Catalog Number: 60923H1-DC

Clip-on Welding Shield: No

Compatible with 3M™ PAPR Systems: No

Compatible with 3M™ Supplied Air System: No

Dimensions and Classifications

Overall Height (Imperial): 8.2 in

Overall Height (Metric): 20.828 cm

Overall Length (Imperial): 4.38 in

Overall Length (Metric): 11.1125 cm

Overall Width (Imperial): 4.6 in

Overall Width (Metric): 11.684 cm

3M™ DBI-SALA® Confined Space Davit Arm 8516693, 1 EA

Part Number 8516693 3M Product Number 8516693 3M ID 7100188843

Details

The 3-way SRL with emergency retrieval or winch attach easily to mounting bracket

Built-in secondary fall-arrest anchor point

Durable construction

Optional rescue davit for fall arrest post

Recommended for use in many industries

Appropriate for Fall Protection in electrical transformer applications

Includes cable stabiliser strap

Lightweight, corrosion resistant aluminum construction

Order 8516691 fall arrest post and winch/SRL separately

Typical properties

Brands: DBI-SALA®

Case Quantity: 1

Connected Safety ID Equipped: No

For Use With: Portable Fall Arrest Post

Install Type: Portable

Net Weight (Imperial): 22.1 lb

Net Weight (Metric): 10 kg

Pole Adjustment Range: 8-16 ft. (2.4-4.8m)

Product Color:

Dimensions and Classifications

Overall Height (Imperial): 31.24 in

Overall Height (Metric): 79.35 cm

3M™ Scott™ Mobile Air Cart

3M ID B5005047154

Details

Portable, lightweight air supply with large wheels and a low center of gravity for ease of mobility and maneuverability

Loud end-of-service-time indicator whistle for clear, notification of low cylinder pressure

High Pressure Inlet Supply Connector provides the ability to utilize a high-pressure supply for continuous air supply capability

Auxiliary dual tool outlets, with internal check valve to prevent contamination of respirator manifold (certain models)

Available with Hansen, Schrader and other airline fittings

Optional tool supply outlets with Checked Tool Supply Outlets provides the ability to supply up to two air powered tools while preventing cross contamination of respirator manifold

Typical properties

Brands

Scott™

Connection Type

Compressed Air Line

Gauge Type

Mechanical

Product Type

Air Source

3M™ DBI-SALA® Leading Edge Tripod Anchor For Concrete 2190074

Part Number 2190074 3M Product Number 2190074 3M ID 7012818380

Details

Installs to rebar ring during pre-cast concrete work. Installs in seconds utilizing built-in ratcheting securement system

Built-in ratcheting securement system. Allows user to secure anchor in place quickly without special tools

Dual-use design can also be used as end anchors for a 2-person temporary 3M™ DBI-SALA® Horizontal Lifeline System

For use with 3M™ DBI-SALA® Smart Lock Leading Edge Self-Retracting Lifeline (Sold Separately), designed to know the difference between regular movement and a fall—reducing unintentional lockups.*Compared to our previous generation SRLs

Portable and reusable. Anchor can be removed and simply reinstalled in a new location for added jobsite flexibility

Typical properties

Anchor Hook Material

Metal

Anchor Install Type

Reusable

Brands

DBI-SALA®

Case Quantity

1 EA

Connected Safety ID Equipped

No

For Use With

3M™ DBI-SALA® Smart Lock Self-Retracting Lifeline (SRL)

Housing Material

Steel Only

Housing Type

Stainl

Dimensions and Classifications

Overall Length (Imperial)

24 in

3M™ GoggleGear™ 500 Series Safety Goggles

Details

Low-profile design
Adjustable elastic strap
Indirect ventilation
3M™ Scotchgard™ Protector Anti-Fog/Anti-Scratch Coating
D3 (droplet and splash) and D4 (dust) rated
Meets the Impact-Rated Protector requirement of the ANSI-ISEA Z87.1-2020 Standard

Typical properties

3M Technology
Scotchgard Anti-Fog Coating
ANSI Requirements
ANSI Z87.1-2003 and CSA Z94.3-2007
Anti Fog Lens
Yes
Brands
GoggleGear™
Case Quantity
10
Class
Premium
Comfort Features
Adjustable elastic strap, Indirect ventilation, Low profile fr

Dimensions and Classifications

Overall Height (Metric)
26.04 cm

3M™ Adflo™ Turbo Assembly 35-5401-01, Lithium Ion Battery, 1 EA/CASE

3M Product Number 35-5401-01 3M ID 7100200529 UPC 00076308943257

Details

Turbo Assembly

See resources section below

Connects directly with any Speedglas Series respiratory welding helmet

Gas filters sold as separate accessories (837242 or 837542)

Typical properties

Air Source

PAPR

Battery Life

PAPR: up to 12 hours

Battery Type

PAPR: Lithium ion

Brands

Adflo™

Cartridge or Filter Included

HE Filter

Case Quantity

1

Compatible Welding Helmet

3M™ Speedglas™ L-Series, 9000 Series

Features

Filtrating Air for

3M™ Adflo™ Turbo Assembly Without Belt and Breathing Tube, 35-1499-01, 1 EA/CASE

3M Product Number 35-1499-01 3M ID 7100200534 UPC 00076308943233

Details

Turbo Assembly
No Belt Included
See resources section below

Typical properties

Air Source
PAPR
Battery Life
PAPR: up to 12 hours
Battery Type
PAPR: Lithium ion
Brands
Adflo™
Cartridge or Filter Included
HE Filter
Case Quantity
1
Compatible Welding Helmet
3M™ Speedglas™ L-Series, 9000 Series
Intrinsically Safe
No
Lens

3M™ SecureFit™ Safety Helmet Replacement Suspension Systems

Details

3M Pressure Diffusion Technology
Fits 3M SecureFit™ Safety Helmet series X5000 and X5500

Typical properties

Case Quantity

20,10

Compatible Hard Hat

H-700, H-700T, H-800, X5000, X5500

For Use With

3M™ H-700 Hard Hats, 3M™ Safety Helmet, Hard Hats

Product Color

Black

Product Series

H-700, X5000

Product Type

Suspension Replacement System, Suspension for

3M™ E-A-R™ EXPRESS™ Pod Plugs™ Probed Test Plugs 393-2008-50, 50 PR/Case

3M Product Number 393-2008-50 3M ID 7000052879 UPC 10080529190816

Details

These test earplugs are modified with a probe tube for use during earplug fit testing with the 3M™ E-A-Rfit™ Validation System

50 PR Per Case

3M PSD products are for occupational use only

*The NRR may overestimate the hearing protection provided during typical use

Typical properties

Brands

E-A-R™

Case Quantity

50

Insertion Style

Push-to-fit

Material

Polyurethane

Product Color

Blue, Yellow

Product Series

E-A-Rfit

Product Type

Probed Test Earplug

Recommended Application

Health & Safety Testing

eClass 14 Classification G

3M™ E-A-R™ Classic™ Plus Probed Test Plugs 393-2009-50, 50 EA/Case

3M Product Number 393-2009-50 3M ID 7000052880 UPC 10080529190823

Details

These test earplugs are modified with a probe tube for use during earplug fit testing with the 3M™ E-A-Rfit™ Validation System

50 PR Per Case

3M PSD products are for occupational use only

*The NRR may overestimate the hearing protection provided during typical use

Typical properties

Brands

E-A-R™

Case Quantity

50

Earplug Shape

Cylinder

Material

PVC

Product Color

Yellow

Product Series

E-A-Rfit

Product Type

Probed Test Earplug

Recommended Application

Health & Safety Testing

Recommended Industry

Commercial Buildings, De

3M™ E-A-Rfit™ Mic Clips 073-100 , 10/Each

3M ID 7100105873 UPC 00051131275447

Details

Replacement clips for E-A-Rfit™ microphone

10 EA Per Case

3M PSD products are for occupational use only

*The NRR may overestimate the hearing protection provided during typical use

Typical properties

Brands

3M™

Product Type

Microphone Clip

Recommended Application

Health & Safety Testing

eClass 14 Classification Group

40270102

3M™ Goggle Gear, 500-Series, GG501SGAF-LENS, Clear Scotchgard™ Anti-fog Replacement Lens, 20 ea/Case

3M Product Number GG501SGAF-LENS 3M ID 7100222787 UPC 50051131279341

Details

3M™ Scotchgard™ Protector Anti-fog coated replacement lens available for
3M™ GoggleGear™ 500 Series Goggles

3M™ Scotchgard™ Anti-Fog Coating provides fog and abrasion resistance
Resists fogging longer than traditional anti-fog coatings, up to 25 washings with
water*

The coating withstands disinfection with diluted bleach soaking or alcohol wipes
without losing its anti-fog performance

3M™ Scotchgard™ Anti-Fog Coated Eyewear meets the requirements of ANSI
Z87.1-2015 and CSA Z94.3

*3M internal testing per EN168 test method when compared with traditional anti-
fog coatings

Typical properties

Anti Fog Lens

Yes

Brands

GoggleGear™

Case Quantity

20

Comfort Features

Adjustable elastic strap, Indirect ventilation, Nylon, Polycarbonate lens, Soft
rubber seal

Hard Coat Lens

No

Lens Coating

Anti-scratch & Anti-fog

Lens Color

Clear

Produc

3M™ Scott™ AV-632 Bayonet Adapter

3M ID B5005285023

Details

Includes 5 adapters per box

Simple, quick quarter turn for easy attachment

Adapter allows 3M™ Bayonet Cartridges and Filters to be used with 3M™ Scott™ Full Facepiece Respirators AV-3000 SureSeal and AV-3000 HT NIOSH approved with AV-3000 SureSeal and AV-3000 HT full facepiece respirators

Typical properties

Brands

Scott™

eClass 14 Classification Group

40220191

3M™ PELTOR™ CH-3 Listen Only Hearing Protector HT52A-112, Headband, 1 ea/Case

3M Product Number HT52A-112 3M ID 7100203299

Details

Hearing protection solution with clear audio reception in noisy environments
FLX2 connection jack for easy and reliable connection to a wide assortment of handheld devices
Lasting comfort for long duration wear times
Designed to withstand harsh environmental elements
Audio speakers are optimized for speech frequencies and meet the efficiency demands of many of today's digital devices
Bright yellow color for enhanced visibility
Flexible yet sturdy headband design adapts to a wide variety of head shapes and sizes

Typical properties

Attenuation Rating
26 dB
Audio Type
Communication
Auxiliary Port
FLX2
Brands
PELTOR™
CSA Class
CSA Class A
Case Quantity
1
Communication Direction
Listen-only
Communication Type
Listen Only
Communication via External 2-Way Radio
Yes
Conn

3M™ PELTOR™ CH-3 Listen Only Hearing Protector HT52P3E-112, Hard Hat Attached, 1 ea/Case

3M Product Number HT52P3E-112 3M ID 7100203302 UPC 04054596695535

Details

Hearing protection solution with clear audio reception in noisy environments
FLX2 connection jack for easy and reliable connection to a wide assortment of handheld devices
Lasting comfort for long duration wear times
Designed to withstand harsh environmental elements
Audio speakers are optimized for speech frequencies and meet the efficiency demands of many of today's digital devices
Bright yellow color for enhanced visibility
Flexible yet sturdy hard hat attachment design adapts to a wide variety of head shapes and sizes, and fits most slotted hard hats

Typical properties

Attenuation Rating
25 dB
Audio Type
Communication
Auxiliary Port
FLX2
Brands
PELTOR™
CSA Class
CSA Class BL
Case Quantity
1
Communication Direction
Listen-only
Communication Type
Listen Only
Communication via External 2-Way Radio
Yes
Con

3M™ PELTOR™ CH-3 Listen Only Hearing Protector HT52B-112, Neckband, 1 ea/Case

3M Product Number HT52B-112 3M ID 7100203298

Details

Hearing protection solution with clear audio reception in noisy environments
FLX2 connection jack for easy and reliable connection to a wide assortment of handheld devices
Lasting comfort for long duration wear times
Designed to withstand harsh environmental elements
Audio speakers are optimized for speech frequencies and meet the efficiency demands of many of today's digital devices
Bright yellow color for enhanced visibility
Flexible yet sturdy neckband design adapts to a wide variety of head shapes and sizes, and can be worn with most hard hats

Typical properties

Attenuation Rating
25 dB
Audio Type
Communication
Auxiliary Port
FLX2
Brands
PELTOR™
CSA Class
CSA Class B
Case Quantity
1
Communication Direction
Listen-only
Communication Type
Listen Only
Communication via External 2-Way Radio
Yes
Conn

3M™ Scott™ X3-21 Pro SCBA

3M Product Number X3-21 Pro 3M ID B5005341004

Details

Certified to the NFPA 1986 Standard on Respiratory Protection Equipment for Tactical and Technical Operations, including NIOSH-CBRN certification

Non-reflective, low visibility materials and multiple attachment points allow custom configurations to meet the user's needs

Cost savings and mutual aid may be realized by the ability to share cylinders, air compressors, service centers, training and fit testing

Harness materials offer greater resistance to chemical exposure and less water absorption, helping to minimize contamination

Removable harness designed for easier cleaning to assist with exposure reduction efforts

Natural articulation of the waist pad promotes a greater range of motion to the user while transferring weight to the hips for a more balanced load

Proven regulator design offers low breathing resistance to help reduce user burden

Redundant safety features afford operators peace of mind knowing that the SCBA will perform in critical life safety environments

Typical properties

Brands

Scott™

Product Type

Self-contained Breathing Apparatus

Recommended Industry

Law Enforcement

Specifications Met

NFPA 1986, NIOSH

3M™ Double Locking Rebar Snap Hook 9502058, Aluminum, 3600 lb Gate, 2 1/4 in Throat

3M Product Number 9502058 3M ID 7012821265

Details

Corrosion resistant plated steel hardware
High strength construction with 3,600 lb (16kN) rated gate
Double action and locking gate for added safety
Compact design
Designed to allow horizontal movement along the anchorage, but does not include capability to pass intersecting structures
Compatible with various fall arrest systems
Recommended for use in multiple industries including construction, oil and gas, and utilities
Meets the requirements for 29 CFR OSHA 1910.140, 29 CFR OSHA 1926.502

Typical properties

Attachment Type
Hook, None
Brands
DBI-SALA®
Carabiner/Hook Material
Zinc Plated Steel
Case Quantity
1
Connected Safety ID Equipped
No
Dimensions
110.00x73.00xmm
Install Type
None, Reusable
Product Type
Double action scaffold hook
Recommend

3M™ DBI-SALA® Nano-Lok™ Single-Leg Connector 3100088, Zinc Plated Steel

Part Number 3100088 3M Product Number 3100088 3M ID 7012776939

Details

Single-leg connector attaches Nano-Lok™ directly to harness
High strength steel construction
Corrosion resistant zinc plated design
Extremely compact, lightweight design
Triple locking and self closing gate
Single-leg, twin-leg and fixed D-ring connectors available

Typical properties

Brands
DBI-SALA®
Case Quantity
1
Connected Safety ID Equipped
No
Dimensions
3.40x1.60x0.70in
Housing Type
None
Material
Steel
Mounting Type
Direct to Harness Back
Product Series
Nano-Lok™
Product Type
Single-Leg Connector
Recommended Ind

3M™ Fall Protection Retrofittable Safety Harness Accessories

Details

Fall Protection Harness accessories
Fast and easy installation
Attach to most 3M harnesses
Available in fire-resistant styles
For foot level tie-off, use 3M™ DBI-SALA® Nano-Lok™ edge Twin-Leg QuickConnect SelfRetracting Lifeline – Cable, 8 ft. (2.4 m) 3500228

Typical properties

Anchor Hook Material
Zinc Plated Steel
Anchor Hook Material
Plastic
Anchor Install Type
Reusable
Case Quantity
1,2 EA,8 EA
Connected Safety ID Equipped
No
Dimensions
2.20x1.50x2.20in
For Use With
3M™ DBI-SALA® SecuraSpan™ I-Beam System, Harne

Dimensions and Classifications

Overall Length (Imperial)
1.5 ft, 12 in

3M™ Speedglas™ Breathing Tube Cover SG-15, 1 EA/Case

3M Product Number SG-15 3M ID 7000128115 UPC 00051131498709

Details

Breathing Tube Cover
Accessory Part
Designed for 3M™ Adflo™ Powered Air Respirator
Replacement cover for breathing tube

Typical properties

Brands
Speedglas™
Case Quantity
1
Compatible with 3M™ PAPR Systems
Yes
Compatible with 3M™ Supplied Air System
Yes
Features
Respiratory Accessory
Product Color
Black
Product Series
9100, 9100 FX, 9100 FX-Air, 9100 MP, L-Series, Speedglas 9100

3M™ DBI-SALA® ExoFit STRATA™ Harness

Details

Revolving torso buckles adjust harness fit with ease and speed and lock webbing into place to maintain a comfortable and safe harness fit

Breathable mesh back pad

Personal SRL adapter

Automatic stand-up D-ring enables efficient dorsal connections

Aluminum D-rings

Equipped with auto-resetting lanyard keepers for fast and easy parking of snap hooks and carabiners

Typical properties

Body Belt

No, Yes

Brands

DBI-SALA®

Buckle Type

Dual Lock Quick Connect, Revolver™, Tongue Buckle, Tri-lock Revolver™ Quick Connect

Case Quantity

1

Chest Buckle Material

Zinc Plated Steel

Connected Safety ID Equipped

Yes

D-ring Material

Aircra

3M™ Filter Housing Assembly W-3094M 1 EA/Case

3M Product Number W-3094M 3M ID 7010384897 UPC 00051131985391

Details

This filter housing assembly with an aluminum filter bowl is used with the 3M™ Compressed Air Filter and Regulator Panel W-2806. For industrial applications and environments where chemicals or synthetic lubricants are present

Typical properties

Brands
3M™
CFM Capacity per Minute
50 CFM
Compatible Respirator
256-02-01
Product Color
Metal
Product Series
Supplied Air
Product Type
Housing
Supplied Air Respirator Style
W-Series Fixed Panels

3M™ Versaflo™ Filter Latch Assembly TR-851/94245(AAD), for TR-800 PAPR 1EA

Part Number 94245 3M Product Number TR-851 3M ID 7100150941

Details

Enables simple maintenance of TR-800 blower motors that need a replacement latch

Works with all existing 3M™ Versaflo™ TR-600 series filters and cartridges

Typical properties

Brands

Versaflo™

Case Quantity

1

Compatible Respirator

TR-800 Series

Product Type

Replacement Part

Recommended Application

General Maintenance, Metal Processing, Painting

3M™ Versaflo™ Filter Latch Assembly TR-651, for TR-600 PAPR

3M Product Number TR-651 3M ID 7100134950 UPC 00051131373822

Details

Enables simple maintenance of TR-600

Works with all 3M™ Versaflo™ TR-6000 series filters and cartridges

Replacement part for the 3M™ Versaflo™ Motor/Blower, TR-602N

Typical properties

Brands

Versaflo™

Case Quantity

1/case

Compatible With

3M™ Versaflo™ TR-600 Series PAPR

Hazard Type

Silica

Product Series

TR-600

Product Type

Accessory & Spare Part

Recommended Application

Construction, Demolition, Grinding

Recommended Indust

3M™ DBI-SALA® FlexiGuard™ M100 Adjustable Height Mast

Details

- Powder coated steel upright and gusset components
- Extended rail-length increases safe working area compared to our previous jib systems
- Extended anchor height enhances capabilities in various applications compared to our previous jib systems
- Automatic mast lock helps prevent uncontrolled mast movement
- Aluminum extruded trolley rail with stainless steel / nylon trolley construction
- Rotating mast up to 360 degrees with flip-up rotation handle
- Permanent and portable mounted designs available
- Power assisted height adjustment capability for adjustable models
- Leveling jacks standard on the M100 with integrated fork pockets for transporting and positioning using industrial forklifts
- 3M™ Safety-Walk™ Slip Resistant walking surface (counterweight Bases)
- Additional system mobility with optional caster wheel kit

Typical properties

- Connected Safety ID Equipped
No
- Install Type
Temporary/Portable
- Manufacturing Origin
USA
- Maximum Height (Imperial)
15 ft, 20 ft, 25 ft, 30 ft
- Maximum Height (Metric)
5 m, 6 m, 8 m, 9 m
- Maximum Number of Users
One
- Minimum Height (Imperial)
10

Dimensions and Classifications

- Overall Height (Metric)
0 mm, 640 mm
- Overall Length (Metric)
0 mm, 4900 mm
- Overall Width (Metric)
0 mm, 122 mm

3M™ DBI-SALA® FlexiGuard™ M200 Portable Counterweight Base

Details

- Powder coated steel upright and gusset components
- Extended rail-length increases safe working area compared to our previous jib systems
- Extended anchor height enhances capabilities in various applications compared to our previous jib systems
- Automatic mast lock helps prevents uncontrolled mast movement
- Aluminum extruded trolley rail
- Rotating mast up to 360 degrees with flip up rotation handle
- Permanent or portable mounted designs available
- Stainless steel / nylon construction
- Power assisted height adjustment capability for adjustable models
- Integrated level indicators (Counterweight Bases). Removable counterweight box (Counterweight Bases) with built in fork pockets and lifting ring attachment points (Lifting Kit sold separately). Open multi-directional base designed to accommodate a wide array of fork shapes and sizes
- 3M™ Safety-Walk™ Slip Resistant walking surface (counterweight Bases)
- Additional system mobility with optional caster wheel kit

Typical properties

- Concrete Included
No, Yes
- Connected Safety ID Equipped
No
- Install Type
Temporary/Portable
- Manufacturing Origin
USA
- Maximum Height (Imperial)
6.1 ft
- Maximum Height (Metric)
1.9 m
- Maximum Number of Users
One or Two
- Minimum Height (Imperial)
6

Dimensions and Classifications

- Overall Height (Metric)
1730 mm
- Overall Length (Metric)
2210 mm
- Overall Width (Metric)
180 mm

3M™ Centurion™ 454 Series Safety Impact Goggles

Details

Wide-angle wraparound lens and frame for good peripheral vision
Indirect venting system to help minimize fogging
Accommodates most prescription eyewear
Adjustable elastic strap
Meets the Impact-Rated Protector requirement of the ANSI-ISEA Z87.1-2020 Standard

Typical properties

ANSI Requirements
ANSI Z87.1-2003
Anti Fog Lens
No, Yes
Case Quantity
10
Class
Value
Comfort Features
Fits over most personal prescription eyewear, Indirect ventilation, Neoprene Strap
Eyewear Range
Value
Frame Material
Plastic
Frame Style

Dimensions and Classifications

Overall Height (Imperial)
9.03 in
Overall Height (Metric)
22.94 cm
Overall Length (Imperial)
8 in
Overall Length (Metric)
20.32 cm
Overall Width (Imperial)
8 in
Overall Width (Metric)
20.32 cm

3M™ DBI-SALA® Lad-Saf™ Cable Vertical Safety System

Details

Designed to meet the requirements of the ANSI Z359.16 standard, along with OSHA 1910.140 and 1926.502, when used with our Lad-Saf X3 Detachable Cable Sleeve (6160054) and Lad-Saf X2 Detachable Cable Sleeve (6160030)
Reengineered to simplify and speed up the installation process
Fewer loose parts: Fewer than 13 separate components, up to 72% less than our previous comparable model
Light – weighs less than our previous systems
100% tie-off capability: Integrated fall arrest-rated anchor point on top bracket rated to 3,600 lbs
Flexible: Mounting brackets can be used on a variety of fixed ladder styles that may consist of different rung spacings and shapes
Ideal for billboards and ladders

Typical properties

Anchor Connection Type
Bracket/Nut
Cable Preformation
Left, Regular Lay
Cable Strand
1 x 7
Case Quantity
1
Connected Safety ID Equipped
Yes
Install Type
Permanent
Lifeline Length (Imperial)
20 ft, 30 ft, 40 ft, 50 ft, 60 ft, 70 ft, 80 ft, 90

Dimensions and Classifications

Overall Length (Metric)
6 m, 9 m, 12 m, 15 m, 18 m, 21 m, 24 m, 27 m
Overall Width (Imperial)
0.375 in
Overall Width (Metric)
9.525 mm

3M™ E-A-Rsoft™ Grippers Probed Test Plugs 393-2021-50, 50 Pair/Case

3M Product Number 393-2021-50 3M ID 7010341317 UPC 10078371670167

Details

Unique grip rings help create a soft, noise-blocking seal in the ear canal for effective hearing protection

Noise Reduction Rating (NRR)*: 31 dB. CSA Class AL

This product works with the 3M™ E A Rfit™ Dual Ear Validation System

*The NRR may overestimate the hearing protection provided during typical use

Typical properties

Brands

E-A-Rsoft™

Earplug Shape

Tapered

Earplug Size

Large

Material

Polyethylene

Product Color

Yellow

Product Type

Probed Test Earplug

Recommended Application

Health & Safety Testing

Recommended Industry

Automotive, Construction, Food & Bev

3M™ Scott™ Vision C5 Facepiece with E-Z Flo C5 Regulator

3M ID B5005270009

Details

Approved with the Air-Pak X3 Pro SCBA, compliant to the NFPA 1981 Standard on Open-Circuit Self-Contained Breathing Apparatus for Emergency Services, 2018 Edition

Approved with select Air-Pak SCBA models compliant to the 2013 edition and 2007 edition of NFPA 1981

Wider Field of View - Helps to improve situational awareness

Single Reflex Face Seal - Designed for enhanced comfort and easier donning

Removable 5-Point Head Harness - Helps provide secure fit while minimizing adjustment during donning and easily removable for cleaning

Dual Voicemitters - Enhanced voice transmission—exceeds Speech Transmission Index (STI) requirements for NFPA 1981

PPE Interface - Face seal provides wider landing area with ridges to help improve interface with protective hood

Modular Design - Enables future upgradeability, improves serviceability and provides a platform for use across multiple respiratory applications

Enhanced Breathability - Helps reduce user burden and improve operational efficiencies

Enhanced Communications - Reduced frequency Vibralert helps improve two-way radio communications

Auto Air-Saver - Simplifies operation and helps to prevent inadvertent air loss during removal from the facepiece

Expanded Heads-Up Display - New status icons provide visual alerts to SCBA wearer for electronic personnel accountability report (ePAR), EVAC and System Integrity Alarm (when using Air-Pak X3 Pro SCBA configured with SEMS II Pro Wireless SCBA Telemetry)

External "Buddy" Lights - Assist with remote identification of a user's SCBA air remaining

Recessed Heads-Up Display - Helps improve downward view through facepiece

Quarter-Turn Design - Provides secure connection to the facepiece

Typical properties

Brands

Scott™

Connection Type

Quarter Turn

Suspension Type

4 Point Strap

eClass 14 Classification Group

40220113

3M™ DBI-SALA® ExoFit™ X300 Safety Harness

Details

Revolving Torso Buckles adjust harness fit with ease and speed and lock webbing into place to maintain a comfortable and safe harness fit. Available on select models

Equipped with anti-sliding dorsal D-ring pad to help greatly reduce dorsal D-ring slide

Integrated easy-link SRL adapter lets you quickly and easily connect and disconnect personal SRLs. Available on select models

Auto-locking quick connect buckles secure contact with webbing, reducing the need to readjust. Available on select models

Automatic stand-up D-ring (lightweight aluminum) enables efficient dorsal connections

Low-profile suspension trauma strap design integrated between harness webbing

Equipped with auto-resetting lanyard keepers for fast and easy parking of snap hooks and carabiners

Equipped with an integrated RFID tag, enabling inventory, inspection, and record management

Typical properties

Belly Pad

No

Belt

With, Without

Board/Seat Cushion

No, Yes

Board/Seat Cushion Material

Polyester

Board/Seat Hardware Material

Aluminum

Board/Seat Material

Aluminum, Polyester Webbing

Body Belt

No, Yes

Body Belt Material

Polyester

Brands

D

3M™ Scott™ AV-3000 SureSeal Facepiece

3M ID B5005047143

Details

Top Down Convertibility - Single facepiece is approved across range of respirators from the lowest to highest level of protection (APR, SAR, PAPR and SCBA)

Versatility of facepiece helps lower cost of ownership through reduced fit testing, simplified training and reduced inventory requirements

Available in 3 sizes and with Kevlar®, Rubber or Polyester Head Harness options to meet different customer needs

Fully open front port enables easy communication and breathing without any obstruction when in stand-by mode

Easy to maintain with no exhalation valve to clean or manipulate

Dual voicemitters allow easy communication with or without electronics

Compatible with EPIC 3 Communication Systems

Typical properties

Brands

Scott™

Connection Type

Quarter Turn

Product Type

Full Facepiece

Suspension Type

5 Point Strap

eClass 14 Classification Group

40220113

3M™ Scott™ Air-Pak™ 75 SCBA

3M ID B5005047161

Details

- Available in 2.2, 4.5, or 5.5 cylinder pressures
- Dual-redundant pressure reducer
- Vibralert tactile end of service time indicator (EOSTI) alarm
- Reduced cost of ownership
- Top-down convertibility
- Robust warranty
- Proudly “Made in the USA” with attention to quality and workmanship
- Industry's Best Warranty
- Made in the USA

Typical properties

- Brands
- Scott™
- Product Type
- Self-contained Breathing Apparatus

3M™ SecureFit™ Full Brim Hard Hat H-800

Details

Suspension system incorporates exclusive patented Pressure Diffusion Technology

A smooth, easy turning ratchet suspension system sits low on the head to reduce pressure, helping to make 3M™ SecureFit™ Full Brim Hard Hat H-800 series a comfortable and secure hard hat option

Works with a variety of 3M faceshields, earmuffs, and other accessories

Typical properties

Case Quantity

20

Electrical Class

C, E, G

Features

Pressure Diffusion Technology, UV Indicator

Hard Hat Type

Type I

Product Color

Black, Blue, Gray, Green, High-visibility Orange, High-visibility Yellow, Navy, Orange, Pink, Red, Tan, White, Yellow

3M™ Scott™ EZ-Scape Pro Integrated Self-Rescue Belt

3M ID B5005047171

Details

Provides a reliable means of escape from multi-story or high-rise buildings

One of the lightest, fully integrated escape systems on the market

One-size-fits-most application (adjustable from 30" - 56")

Compliant with NFPA 1981, 2018 edition when worn with a 3M Scott Air-Pak X3 Pro SCBA, as well as NFPA 1983, 2017 edition

Rated for 3034lbs/13kN static load, meeting NFPA 1983:2012 edition for an Escape/Ladder belt

Available with a Crosby hook or Lightning GT hook

Available as a belt-only configuration allowing firefighters to utilize their SCBA as a rated attachment point for their own personal escape bail-out system, or as an attachment point for a ladder belt

Belt-only configuration is just as light, yet stronger and more versatile than existing Air-Pak SCBA waist strap

Waist belt is available as a jettison configuration (removable from the SCBA) or a fixed configuration (non-removable from the SCBA)

Available as a retrofit for Air-Pak X3 Pro, Air-Pak X3, and Air-Pak 75 SCBA

Typical properties

Brands

Scott™

Product Type

Accessory & Spare Part, Rescue Belt

3M™ DBI-SALA® EZ-Stop™ Shock Absorbing Lanyard

Details

Exclusive Vectran™ energy absorption system
Extremely compact and lightweight
Abrasion-resistant webbing
Available in a wide range of web styles and designs
User-friendly self-locking snap hooks
Built-in impact indicator
Ideal for the following applications: Construction, General Industrial, and Oil & Gas

Typical properties

Anchor Connection Type
Comfort Grip Snap Hook, Rebar Hook, Snap Hook, Tie-Back Hook
Anchor Hook Material
Aluminum, Zinc Plated Steel
Case Quantity
1
Connected Safety ID Equipped
Yes
Energy Absorber Class
12 ft. (3.6 m) Free Fall/AAF 1350 lbs. (6

Dimensions and Classifications

Overall Length (Imperial)
4 ft, 6 ft
Overall Length (Metric)
1.83 m

3M™ SecureFit™ SF620SGAF, Clear Scotchgard™ Anti-fog Lens +2.0 Diopter, 20 ea/case

3M Product Number SF620SGAF 3M ID 7100132359 UPC 50051131273486

Typical properties

ANSI Requirements

ANSI Z87.1-2003 and CSA Z94.3-2007

Anti Fog Lens

Yes

Brands

SecureFit™

Case Quantity

20

Comfort Features

+2.0 reading diopter for detail work, Clear polycarbonate lens absorbs 99.9% UVA & UVB rays, Enhanced temple comfort withou

Dimensions and Classifications

Overall Height (Imperial)

10 in

Overall Height (Metric)

25.4 cm

Overall Length (Imperial)

10 in

Overall Length (Metric)

25.4 cm

Overall Width (Imperial)

2 in

Overall Width (Metric)

5.08 cm

3M™ SecureFit™ SF625SGAF, Clear Scotchgard™ Anti-fog lens +2.5 Diopter, 20 ea/case

3M Product Number SF625SGAF 3M ID 7100132360 UPC 50051131273493

Typical properties

ANSI Requirements

ANSI Z87.1-2003 and CSA Z94.3-2007

Anti Fog Lens

Yes

Brands

SecureFit™

Case Quantity

20

Comfort Features

+2.5 reading diopter for detail work, Clear polycarbonate lens absorbs 99.9% UVA & UVB rays, Enhanced temple comfort withou

Dimensions and Classifications

Overall Height (Imperial)

10 in

Overall Height (Metric)

25.4 cm

Overall Length (Imperial)

10 in

Overall Length (Metric)

25.4 cm

Overall Width (Imperial)

5 in

Overall Width (Metric)

12.7 cm

3M™ SecureFit™ Safety Glasses SF615SGAF, Clear Scotchgard™ Anti-fog Lens +1.5 Diopter, 20 EA/Case

3M Product Number SF615SGAF 3M ID 7100132357 UPC 50051131273479

Typical properties

ANSI Requirements

ANSI Z87.1-2003 and CSA Z94.3-2007

Anti Fog Lens

Yes

Brands

SecureFit™

Case Quantity

20

Comfort Features

+1.5 reading diopter for detail work, Clear polycarbonate lens absorbs 99.9%
UVA & UVB, Enhanced temple comfort without

Dimensions and Classifications

Overall Height (Imperial)

10 in

Overall Height (Metric)

25.4 cm

Overall Length (Imperial)

10 in

Overall Length (Metric)

25.4 cm

Overall Width (Imperial)

5 in

Overall Width (Metric)

12.7 cm

3M™ Scott™ Vision C5 Facepiece with Radio Direct Interface

3M ID B5005289010

Details

Approved with the 3M™ Scott™ Air-Pak™ X3 Pro SCBA, compliant to the NFPA 1981 Standard on Open-Circuit Self-Contained Breathing Apparatus for Emergency Services, 2018 Edition

Approved with select Air-Pak™ SCBA models compliant to the 2013 edition and 2007 edition of NFPA 1981

Radio Direct Interface - Wireless radio communications utilizing existing compatible radios

In-Mask Communications - Enhanced voice intelligibility during two-way radio communications

Bone Conduction Headphone - Enhances hearing and understanding of incoming two-way radio communications

Automated Voice Prompts - Provide verbal notification of changing system conditions

Integrated Volume Switch - Adjust volume based on hearing acuity and environmental conditions

Rechargeable Battery - Intrinsically safe lithium-ion battery

Single-Button Operation - Simple, intuitive operation for powering on/off electronics

Multipurpose Solution - Continuous operation when transitioning between tactical (on air) and non-tactical (off air) operations

Multi-Platform Solution - Approved with compatible 3M™ Scott™ Air-Pak™ SCBA and compatible two-way radios

Software Configurable - Modify settings using iOS or Android™ compatible mobile applications

Enhanced Communications - Reduced frequency Vibralert EOSTI helps improve two-way radio communications

2-Bay Charger - Simultaneously charges two batteries using an AC/DC power supply or hard-wired, vehicle-mount connection

Typical properties

Brands

Scott™

Connection Type

Quarter Turn

Suspension Type

4 Point Strap

eClass 14 Classification Group

40220113

3M™ DBI-SALA® ShockWave™ Shock Absorbing Lanyard

Details

Stretches in reaction to users movements
Energy absorbing design limits fall arrest forces
Abrasion-resistant webbing
Available in a wide range of web styles and designs
Built-in impact indicator
Protected labels equipped with 3M™ Connected Safety ID (CSID)
Ideal for the following applications: Construction, General Industrial, Mining, Oil & Gas, Transportation, Utilities, and Wind Energy

Typical properties

Anchor Connection Type
Comfort Grip Snap Hook, Rebar Hook, Snap Hook
Anchor Hook Material
Aluminum, Zinc Plated Steel
Case Quantity
1
Connected Safety ID Equipped
Yes
Energy Absorber Class
6 ft (1.8 m) Free Fall/MAAF 900 lbs. (4 kN)
Harness Conn

Dimensions and Classifications

Overall Length (Imperial)
6 ft
Overall Length (Metric)
1.829 m

3M™ PELTOR™ System Control Unit SCU-300NA CY, Brown, 20 ea/Case

3M Product Number SCU-300NA CY 3M ID 7100224665 UPC 07318640070660

Details

Single, DUAL, and Multi COMMS configurable

The SCU can handle multiple radios, with multiple channels. In such scenarios, the user is able to select one of three preset sound profiles: Mix, Split and Surround

The SCU-300 lets you experience a cable-free connection between the SCU and compatible headsets (3M™ PELTOR™ ComTac VII, and 3M™ PELTOR™ Tactical Earplug, TEP-300)

The SCU utilize Near Field Magnetic Induction (NFMI), for wireless transmission of audio to headsets

The steep degradation of NFMI signal strength as a function of distance increases privacy and reduces issues with interference compared to traditional wireless technology

The SCU can be remotely operated via the remote control unit - RCU (included)

The RCU allows an operator to push transmission without having to remove their hand from the weapon system

Typical properties

Battery Life

Approx. 30 hr

Battery Type

Disposable AAA, Rechargeable AAA

Bluetooth

No

Brands

PELTOR™

Case Quantity

20

Compatible With

ComTac VII Headset, RCU-300 Remote Control Unit, TEP-300 Tactical Earplug

Connection Type

Wired, Wireless

P

3M™ PELTOR™ System Control Unit SCU-300NA WS GE, Gray, 20 ea/Case

3M Product Number SCU-300NA WS GE 3M ID 7100223396 UPC 07318640070677

Details

Single, DUAL, and Multi COMMS configurable

The SCU can handle multiple radios, with multiple channels. In such scenarios, the user is able to select one of three preset sound profiles: Mix, Split and Surround

The SCU-300 lets you experience a cable-free connection between the SCU and compatible headsets (3M™ PELTOR™ ComTac VII, and 3M™ PELTOR™ Tactical Earplug, TEP-300)

The SCU utilize Near Field Magnetic Induction (NFMI), for wireless transmission of audio to headsets

The steep degradation of NFMI signal strength as a function of distance increases privacy and reduces issues with interference compared to traditional wireless technology

The SCU can be remotely operated via the remote control unit - RCU (included)

The RCU allows an operator to push transmission without having to remove their hand from the weapon system

Typical properties

Battery Life

Approx. 30 hr

Battery Type

Disposable AAA, Rechargeable AAA

Bluetooth

Yes

Brands

PELTOR™

Case Quantity

20

Communication Type

Bluetooth

Compatible With

ComTac VII Headset, RCU-300 Remote Control Unit, TEP-300 Tactical Earplug Con

3M™ Scotchlite™ Reflective Material 9687 Series

Details

3M™ Scotchlite™ Reflective Material is designed for enhancing visibility in low light and nighttime conditions
Certified to various flame resistant standards such as EN 469
Fluorescent properties help to make material highly visible in daylight, dawn and dusk
The fabric backing is printed with 3M trademarks for easy identification
Sew-on application

Typical properties

Adhesive
None
Attachment Type
Sew On
Backing Material
Aramid
Brands
Scotchlite™
Daytime Color
Yellow/Silver
Flame Resistant
Yes
Home Wash Cycles 60°C (140°F) at ANSI Certified Standards
50
Initial Average RA
500
Product Series
9687
Recom

Dimensions and Classifications

Overall Length (Imperial)
109.36 yd
Overall Length (Metric)
100 m
Overall Width (Imperial)
2 in, 3 in, 20 in
Overall Width (Metric)
50.8 mm, 76.2 mm, 508 mm

3M™ DBI-SALA® Nano-Lok™ Extended Length Self-Retracting Lifelines

Details

Impact-resistant housing made of tough thermoplastic housing designed to help withstand demanding worksites
Speed-sensing brake system provides as low as 6 ft. (2m) of required fall clearance
Swiveling anchorage loop limits lifeline twisting for smooth operation
Impact indicator provides a visual alert that the SRL has been involved in a fall
Web lifeline
High-capacity external energy absorber designed for users (and tools) up to 420 lbs. (190kg)

Typical properties

ANSI Class Level
Class 1
Anchor Connection Type
Cab-mount Bracket, Carabiner
Anchor Hook Material
Stainless Steel, Zinc Plated Steel
Anchor Hook Material
Aluminum, Stainless Steel, Zinc Plated Steel
Average Arrest Force (Imperial)
1125 lbf (ANSI)

Dimensions and Classifications

Overall Length (Imperial)
9 ft, 11 ft, 15 ft, 20 ft
Overall Length (Metric)
2.7 m, 2.74 m, 3.3 m, 3.4 m, 4.572 m, 6.096 m

3M™ Scotchlite™ Reflective Material 9186, Fluorescent Red-Orange Industrial Wash Flame Resistant Trim, 76.2 mm x 100 m, 4/Case

3M Product Number 9186 3M ID 7010391763 UPC 00051131171053

Details

3M™ Scotchlite™ Reflective Material is designed for enhancing visibility in low light and nighttime conditions
Certified only to NFPA 2112 for flash fire applications
Fluorescent properties help to make material highly visible in daylight, dawn and dusk
The fabric backing is printed with 3M trademarks for easy identification
Sew-on application

Typical properties

Adhesive
None
Attachment Type
Sew On
Brands
Scotchlite™
Certified Performance Required
CGSB, NFPA
Daytime Color
Fluorescent Red-Orange
Flame Resistant
Yes
Initial Average RA
500
Product Series
9186
Technology
Beaded
Wash Method
Industri

Dimensions and Classifications

Overall Length (Imperial)
109.36 yd
Overall Length (Metric)
100 m
Overall Width (Imperial)
3 in
Overall Width (Metric)
76.2 mm

3M™ DBI-SALA® Rebar/Positioning Lanyard

Details

Ideal for work positioning
Extremely durable twist link chain construction
Self-locking aluminum rebar hook with swivel at center
User friendly aluminum self locking snap hooks at leg ends
Equipped with 3M™ Connected Safety ID (CSID)

Typical properties

Anchor Connection Type
Rebar Hook
Anchor Hook Material
Aluminum, Zinc Plated Steel
Case Quantity
1
Connected Safety ID Equipped
Yes
Energy Absorber Class
None
Harness Connection Hook Material
Zinc Plated Steel
Harness Connection Type
Snap Hoo

Dimensions and Classifications

Overall Length (Imperial)
20.5 in, 22 in, 24 in

3M™ Speedglas™ Welding Lens 9100, 06-0005-P13, Passive Shade 13, 2 Ea/Case (Replacement Lens Only)

3M Product Number 06-0005-P13 3M ID 7010342412 UPC 00051141563534

Details

Replacement lens only (Welding filter adaptor not included)
Passive shade 13

Typical properties

ADF Viewing Area (hwxw)

2.8x4.2in

Brands

Speedglas™

Compatible Welding Helmet

9100 Series, M-400SG Series

For Use With

3M™ Speedglas™ 9100 Air Welding Helmets, 3M™ Speedglas™ 9100 Welding Helmets, 3M™ Speedglas™ 9100FX Welding Helmets, 3M™ Speedglas

3M™ Speedglas™ Welding Lens 9100, 06-0005-P11, Passive Shade 11, 2 Ea/Case (Replacement Lens Only)

3M Product Number 06-0005-P11 3M ID 7010316592 UPC 00051141563190

Details

Replacement lens only (Welding filter adaptor not included)
Passive shade 11

Typical properties

ADF Viewing Area (hwxw)

2.8x4.2in

Brands

Speedglas™

Compatible Welding Helmet

9100 Series, M-400SG Series

For Use With

3M™ Speedglas™ 9100 Air Welding Helmets, 3M™ Speedglas™ 9100 Welding Helmets, 3M™ Speedglas™ 9100FX Welding Helmets, 3M™ Speedglas

3M™ Speedglas™ Welding Lens 9100, 06-0005-P12, Passive Shade 12, 2 Ea/Case (Replacement Lens Only)

3M Product Number 06-0005-P12 3M ID 7010385033 UPC 00051141563206

Details

Replacement lens only (Welding filter adaptor not included)
Passive shade 12

Typical properties

ADF Viewing Area (hwxw)

2.8x4.2in

Brands

Speedglas™

Compatible Welding Helmet

9100 Series, M-400SG Series

For Use With

3M™ Speedglas™ 9100 Air Welding Helmets, 3M™ Speedglas™ 9100 Welding Helmets, 3M™ Speedglas™ 9100FX Welding Helmets, 3M™ Speedglas

3M™ Speedglas™ Welding Lens 9100, 06-0005-P10, Passive Shade 10, 2 Ea/Case (Replacement Lens Only)

3M Product Number 06-0005-P10 3M ID 7010385032 UPC 00051141563183

Details

Replacement lens only (Welding filter adaptor not included)
Passive shade 10

Typical properties

ADF Viewing Area (hwxw)

2.8x4.2in

Brands

Speedglas™

Compatible Welding Helmet

9100 Series, M-400SG Series

For Use With

3M™ Speedglas™ 9100 Air Welding Helmets, 3M™ Speedglas™ 9100 Welding Helmets, 3M™ Speedglas™ 9100FX Welding Helmets, 3M™ Speedglas

3M™ PELTOR™ ComTac™ VI Tactical Headsets

Details

Protective communication solution for clear communication in noisy environments
NIB (Natural Interaction Behavior) wireless technology enables peer-to-peer headset communication

Environmental microphones for level-dependent hearing protection and auditory situational awareness

Water and dust-proof noise-cancelling microphone (IP68) for clear speech transmission in noisy and harsh environments

Advanced environmental listening modes (Mission Audio Profiles or MAP) that optimize the auditory experience based on specific external conditions

Helps provide hearing protection when exposed to hazardous noise

Rugged 3M™ PELTOR™ Design for trusted performance

Typical properties

Attenuation Rating

23 dB, 20 dB, 21 dB, 22 dB

Audio Type

Communication

Battery Life

Approx. 30 hours (NIB), Approx. 50 hours

Battery Type

Disposable AAA, Rechargeable AAA

Bluetooth

No

Brands

PELTOR™

Case Quantity

10

Communication Direction

Two

3M™ SecureFit™ 3700 Series Safety Glasses

Details

3M's innovative temple design features slotted ribs that provide comfortable pressure equalization, allowing the temples to flex and self-adjust to the size of the wearer's head

Curved temples apply pressure to the less sensitive back of the head, instead of the temples, achieving a comfortable fit even during rapid head movement

Adjustable ratchet temples allows user to adjust lens for facial features and eyeglass position

Soft one-piece nose bridge

Optional contoured brow guard

Choose from models with anti-fog/anti-scratch or 3M™ Scotchgard™ Anti-Fog coating

U6 rated polycarbonate lenses absorb 99.9% of UVA, UVB, and UVC rays between 200 nm and 380 nm

Workers can feel confident wearing 3M eye protection that meets the Impact-Rated Protector requirement of the ANSI-ISEA Z87.1 Standard

Typical properties

Anti Fog Lens

No, Yes

Brands

SecureFit™

Case Quantity

10

Class

Premium

Comfort Features

Adjustable lens angles, Brow and nose bridge, Color-accented temples, Fits over most glasses, Lens angle adjustment, Polycarbonate, Soft nose bridge, Wide wra

3M™ E-A-R™ TaperFit™ 2 Probed Test Plugs 393-2006-50, 50 EA/Case

3M Product Number 393-2006-50 3M ID 7000002388 UPC 10080529190793

Details

These test earplugs are modified with a probe tube for use during earplug fit testing with the 3M™ E-A-Rfit™ Validation System

50 PR Per Case

3M PSD products are for occupational use only

*The NRR may overestimate the hearing protection provided during typical use

Typical properties

Brands

E-A-R™

Case Quantity

50

Earplug Shape

Tapered

Material

Polyurethane

Product Color

Yellow

Product Series

E-A-Rfit

Product Type

Probed Test Earplug

Recommended Application

Health & Safety Testing

eClass 14 Classification Group

402701

3M™ E-A-R™ TaperFit™ 2 Large Probed Test Plugs 393-2027-50, 50 Pair/Case

Part Number 393-2027-50 3M Product Number 393-2027-50 3M ID 7100230133

Details

These test earplugs are modified with a probe tube for use during earplug fit testing with the 3M™ E-A-Rfit™ Dual-Ear Validation System

50 PR Per Case

3M PSD products are for occupational use only

Probed earplugs are for fit testing only; cannot be used for hearing protection

Typical properties

Brands

E-A-R™

Case Quantity

50 pair

Earplug Shape

Tapered

Earplug Size

Large

Material

Polyurethane

Product Color

Yellow

Product Type

Probed Test Earplug

Recommended Application

Assembly, Blasting, Cleaning, Demolition, Facility Maintenance,

3M™ E-A-R™ E-Z-Fit™ Probed Test Plugs 393-2005-50, 50 EA/Case

3M Product Number 393-2005-50 3M ID 7000127699 UPC 10080529190786

Details

These test earplugs are modified with a probe tube for use during earplug fit testing with the 3M™ E-A-Rfit™ Validation System

50 PR Per Case

3M PSD products are for occupational use only

*The NRR may overestimate the hearing protection provided during typical use

Typical properties

Brands

E-A-R™

Case Quantity

50

Earplug Shape

Bell

Material

Polyurethane

Product Color

Yellow

Product Series

E-A-Rfit

Product Type

Probed Test Earplug

Recommended Application

Health & Safety Testing

eClass 14 Classification Group

40270102

3M™ DBI-SALA® Confined Space Tripod Mounting Base Bracket For Winch/SRL 8005048

Part Number 8005048 3M Product Number 8005048 3M ID 7100240881

Details

Base bracket is used to mount a confined space winch or SRL
Portable installation type
Yellow Zinc Construction
310 lbs. (140 kg) personnel / 350 lbs. (159 kg) materials

Typical properties

Brands
DBI-SALA®
eClass 14 Classification Group
15310100

3M™ E-A-Rsoft™ Yellow Neon Blasts™ Earplugs

Details

Expands within the ear canal for comfortable noise reduction
Orange red flame and orange cord provide fun contrast
Compatible with the 3M™ E-A-Rfit™ Validation System
NRR* of 32 dB for the regular size; 33dB in combination with large Yellow Neons
CSA Class AL

*U.S. EPA specifies the NRR as the measure of hearing protector noise reduction. However, 3M makes no warranties as to the suitability of the NRR for this purpose. 3M strongly recommends personal fit testing of hearing protectors. Research suggests that users may receive less noise reduction than indicated by the attenuation label value(s) on the packaging due to variation in fit, fitting skill, and motivation of the user. Refer to applicable regulations or guidance on how to adjust attenuation label values. It is recommended that the NRR be reduced by 50% to better estimate typical protection

Typical properties

Attenuation Rating
33.0 Decibel
Banded
No
Case Quantity
2000 Pair
Cord Color
Orange
Cord Type
None, Vinyl
Corded
No, Yes
Dielectric
No
Dispenser Available
No, Yes
Earplug Material
Foam
Earplug Shape
Bullet
Earplug Size
Regular
Electr

3M™ S-Series PAPR Hoods & Hood Assemblies

Details

S-Series respiratory hoods are specifically designed to work together with your Versaflo™ Respiratory and 3M™ Supplied Air Respirator Systems

- Provides head, face, neck and shoulder coverage from dust and paint spray
- Provides a good field of view
- Helps protect eyes and face from liquid splash and low energy flying particles and dust
- Head impact protection accessory option available for premium hoods
- Versatile accessories available that can help you adapt the hood to your particular environment

Typical properties

Assigned Protection Factor

1000

Brands

Versaflo™

CFM Capacity per Minute

100 CFM, 50 CFM

Case Quantity

1,5,20,10

Compatible With

3M™ Powered Air Purifying and Supplied Air Respirator Systems, 3M™

Versaflo™ Powered Air Purifying and Supplied Air R

3M™ E-A-R™ Push-Ins™ Probed Test Earplugs 393-2002-50, 50 Pair/Case

3M Product Number 393-2002-50 3M ID 7000052881 UPC 10080529190755

Details

These test earplugs are modified with a probe tube for use during earplug fit testing with the 3M™ E-A-Rfit™ Validation System

50 PR Per Case

3M PSD products are for occupational use only

*The NRR may overestimate the hearing protection provided during typical use

Typical properties

Brands

E-A-R™

Case Quantity

50

Insertion Style

Push-to-fit

Material

Polyurethane

Product Color

Blue, Yellow

Product Series

E-A-Rfit

Product Type

Probed Test Earplug

Recommended Application

Health & Safety Testing

Recommended Industry

Comm

3M™ E-A-Rfit™ EARCAPS Test Probe 393-2020, 50 Pair/Case

3M ID 7100113020 UPC 10078371667600

Details

E-A-Rfit™ Test probe for EARCAPS product

50 Pair/Case

3M PSD products are for occupational use only

*The NRR may overestimate the hearing protection provided during typical use

Typical properties

Brands

3M™

Case Quantity

50

Product Type

Probed Test Earplug

Recommended Application

Health & Safety Testing

eClass 14 Classification Group

40270102

3M™ Push-Ins™ Probed Test Plugs 393-2015-50, with Grip Rings, 50 EA/Case

3M Product Number 393-2015-50 3M ID 7000148552 UPC 10078371660397

Details

EARfit™ Test probe for Push-Ins™ earplug

Flexible stem makes insertion and removal easy and helps keep the tips clean when the wearer's hands are dirty

No roll-down required

*The NRR may overestimate the hearing protection provided during typical use

Typical properties

Brands

E-A-R™

Case Quantity

50

Material

Polyurethane

Product Color

Blue, Yellow

Product Series

E-A-Rfit

Product Type

Probed Test Earplug

Recommended Application

Health & Safety Testing

eClass 14 Classification Group

40270102

3M™ Speedglas™ G5-03 Pro-Air Welding Helmet with 3M™ V-100 Vortex Cooling Valve Assembly 45-5702-00, No ADF, 1 EA/Case

3M Product Number 45-5702-00 3M ID 7100311731 UPC 00638060430712

Details

Robust, compact design
Ergonomic, adjustable head suspension
GRIND and CUT mode functionality, when using G5 auto darkening filters
ADF sold separately

Typical properties

ADF Model
None
Air Source
SAR
Brands
Speedglas™
Case Quantity
1
Comes with Auto-Darkening Filter (ADF)
No
Headgear Type
Welding Helmet
Lens Type
No Lens
Product Type
Auto-darkening Welding Helmet with Supplied Air Regulator
Safety Helmet I

3M™ DBI-SALA® Rollgliss™ R550 Oil and Gas Rescue and Descent Device Kit with Rescue Wheel 3300005, Kernmantle Rope, 200 ft

Part Number 3300005 3M Product Number 3300005 3M ID 7100231777

Details

Rescue System includes items to facilitate a rescue from most working locations on the structure

Rescue System is intended for the oil and gas drilling and service industry
Pictorial label cards provided for EA pocket allow for quick location identification and proper product use

Rescue System contents are organized and secured within designated pockets.

Fall protection for tools incorporated for all content within the bag

Bag is compact and incorporates versatile pocket storage

Bag has a rated lifting point integrated on top

Rescue System is easy to use

Bag incorporates padded shoulder straps to provide comfort while carrying. The ridged bag design keeps bag aligned with the worker while climbing structure

Includes: Part Number Description Qty: 3620007 6' Web Sling 2 EA, 3620008 1' 3/4" Web Sling 2 EA, 1500055 10lb. tool tether 4 EA, 2000300 2" gate opening carabiner 1 EA, 2000112 Steel Carabiner 4 EA, 9514753 Micro Pulley 1 EA, 3320046 RA Edge Protector 1 EA, 1500047 Bungee Tether 1 EA, 5000028 Cable Grab 1 EA, 5000032 Web Grab 1 EA, 3327200 R550 Rescue Unit - 200' 1 EA,

Optional Order Separately: 8900298 Rescue Pole 1 EA, 1200207 Web Strap Angled Decent 1 EA, 8800023 Double Pulley Angled Descent 1 EA, 1231545 Web Lanyard 2 Ends 9502116 1 EA

Typical properties

Brands

DBI-SALA®

Dimensions

11"x21"x16"

Housing Material

Aluminum

Lifeline Material

Kernmantle, Braided Polyester Cover with Nylon Filament Core

Maximum Number of Users

Two

Product Color

Red

Product Type

Oil & Gas Rescue System

Recommended I

3M™ Scott™ AV-3000 SS/HT Transparent Peel Off 201839-22, 25/Pack

3M Product Number 201839-22 3M ID 70002009903

Details

Use with 3M™ Scott™ AV-3000 SureSeal or 3M™ Scott™ AV-3000 HT Facepieces (sold separately)

Designed to help reduce glare from high level ambient light while also protecting the lens from dirt and debris

Not for use in welding or other applications that require reduction of UV or IR radiation beyond the capability of normal nonprescription sunglasses

Not for use in high heat environments

Refer to the NIOSH approval label for approved configurations

Typical properties

Brands

Scott™

Case Quantity

25 EA/bag

Compatible With

3M™ Scott™ ACSi SCBA, 3M™ Scott™ AV-3000 HT Facepiece with Approved Cartridges & Filters APR, 3M™ Scott™ AV-3000 SS Facepiece with Approved Cartridges & Filters APR, 3M™ Scott™ Air-Pak™ 75i SCBA,

3M™ Versaflo™ Tinted Peel-Off Covers M-923-25, for M-925 Standard Visor, 25 ea/Case

3M Product Number M-923 3M ID 7100286571 UPC 50076308401172

Details

Tinted
Peel-off
Helps reduce glare
Replaceable protective covering for visor
For Standard Visor M-925

Typical properties

Brands
Versaflo™
Case Quantity
25
Compatible With
3M™ Versaflo™ M-Series Headgear, 3M™ Versaflo™ M-Series Helmet
Product Color
Gray
Product Series
M-Series
Product Type
Faceshield Cover

3M™ Versaflo™ Multi Layer Peel-Off Visor Cover, S-923-50, for S-600 S-700 and S-800 Assemblies 50 EA/Case

3M Product Number S-923-50 3M ID 7010385074 UPC 50051141567124

Details

4 layer peel off film helps protect the visor from contaminants and scratches
Multi-layer peel-off helps extend the life of the hood in a paint spray application
Full perimeter adhesive enables for easy attachment to visor

Typical properties

Brands

Versaflo™

Compatible With

3M™ S-Series Headgear

Product Color

Transparent

Product Series

S-Series

Product Type

Faceshield Cover

Recommended Application

Painting

Recommended Industry

Automotive, General Manufacturing, Military Maintenance

3M™ Versaflo™ Multi Layer Peel-Off Visor Cover, S-923-10, for S-600 S-700 and S-800 Assemblies 10 EA/Case

3M Product Number S-923-10 3M ID 7010316605 UPC 00051141567136

Details

4 layer peel off film helps protect the visor from contaminants and scratches
Multi-layer peel-off helps extend the life of the hood in a paint spray application
Full perimeter adhesive enables for easy attachment to visor

Typical properties

Brands

Versaflo™

Compatible With

3M™ S-Series Headgear

Product Color

Transparent

Product Series

S-Series

Product Type

Faceshield Cover

Recommended Application

Painting

Recommended Industry

Automotive, General Manufacturing, Military Maintenance

3M™ Scott™ AV-3000 SS/HT Clear Peel Off 201839-11, 25/Pack

3M Product Number 201839-11 3M ID 70002009911

Details

Use with 3M™ Scott™ AV-3000 SureSeal or 3M™ Scott™ AV-3000 HT Facepieces (sold separately)
Helps protect the lens from dirt and debris
Fits easily onto lens
Not for use in high heat environments
Refer to the NIOSH approval label for approved configurations

Typical properties

Brands

Scott™

Case Quantity

25 EA/bag

Compatible With

3M™ Scott™ ACSi SCBA, 3M™ Scott™ AV-3000 HT Facepiece with Approved Cartridges & Filters APR, 3M™ Scott™ AV-3000 SS Facepiece with Approved Cartridges & Filters APR, 3M™ Scott™ Air-Pak™ 75i SCBA,

3M™ Versaflo™ Tinted Peel-Off Covers M-924, for M-927 Premium Visor, 25 ea/Case

3M Product Number M-924 3M ID 7100288242 UPC 50638060434586

Details

Tinted
Peel-off
Helps reduce glare
Replaceable protective covering for visor
For Premium Visor M-927

Typical properties

Brands
Versaflo™
Case Quantity
25
Compatible With
3M™ Versaflo™ M-Series Headgear, 3M™ Versaflo™ M-Series Helmet
Product Color
Gray
Product Series
M-Series
Product Type
Faceshield Cover

3M™ Versaflo™ Peel-Off Visor Cover S-922, for S-600 S-700 and S-800 Assemblies 40 EA/Case

Part Number 37302 3M Product Number S-922 3M ID 7100138630

Details

Transparent visor cover
Helps protect visor from contaminants and scratches

Typical properties

Brands
Versaflo™
Compatible With
3M™ M-Series Headgear
Headgear Type
Hood
Product Color
Transparent
Product Series
S-Series, Versaflo
Product Type
Faceshield Cover, Replacement Parts & Accessories
Recommended Application
Assembly & Mechanical

3M™ DBI-SALA® Nano-Lok™ Edge Twin-Leg Personal Self Retracting Lifeline 3500279, Cable, Steel Snap Hook, 8 ft., Class 2, ANSI

3M Product Number 3500279 3M ID 7012819225 UPC 00648250243473

Details

- Designed for foot-level tie-off and leading edge applications
- Compact Design
- Quick activating speed sensing brake system
- Durable thermoplastic housing
- Built-in connector for direct attachment to harness
- High capacity external energy absorber and impact indicator
- RFID equipped and compatible with inventory management system
- Available in multiple styles and configurations

Typical properties

- ANSI Class Level
- Class 2
- Average Arrest Force (Imperial)
- 900 lbf (ANSI), 900 lbf (OSHA 130 lb - 310 lb)
- Average Arrest Force (Metric)
- 4 kN (ANSI), 4 kN (OSHA 130 lb - 310 lb)
- Brands
- DBI-SALA®
- Case Quantity
- 1.0 per Case
- Connected Safety ID Equipp

Dimensions and Classifications

- Overall Length (Imperial)
- 8 ft
- Overall Length (Metric)
- 2.44 m

3M™ Versaflo™ Peel-Off Visor Cover, S-920L, Medium/Large, for Integrated Suspension Products, 40 ea/Bag

3M Product Number S-920L 3M ID 7000127434 UPC 50051131170990

Details

Transparent visor cover
Helps protect visor from contaminants and scratches

Typical properties

Brands
Versaflo™
Compatible With
3M™ S-Series Headgear
Headgear Type
Hood
Product Color
Transparent
Product Series
S-Series, Versaflo
Product Type
Faceshield Cover
Recommended Application
Facility Maintenance, General Maintenance
Recommended

3M™ Speedglas™ G5-02 Welding Helmet 08-0100-50iC, with Curved ADF, Headband, Cleaning Wipe and Bag, 1 ea/Case

Part Number 08-0100-50iC 3M Product Number 08-0100-50iC 3M ID 7100239917

Details

Our largest Auto-Darkening Lens field of view ever (150x76 mm), utilizing the 3M™ Speedglas™ Curved Glass Technology
Bluetooth connectivity with app management
Great clarity before, during and after welding, with our 3M™ Speedglas™ Natural Color Technology
By selecting just the right settings for each task, you help reduce eye strain and can help improve the quality of every weld
Highly sensitive arc detection ideal for TIG welding operations
Delay function to set the dark-to-light opening time
Light state 2.5

Typical properties

ADF Model
G5-02
ADF Viewing Area (Metric)
150 mm x 76 mm
Brands
Speedglas™
Comes with Auto-Darkening Filter (ADF)
Yes
Features
Advanced Headgear, Eye & Face Protection
Front Panel Included
Yes
Headband Included
Yes
Headgear Type
Welding Hel

Dimensions and Classifications

ADF Viewing Area (Imperial)
5.9 in x 2.9 in

3M™ Lens Cover 7899-25/7899-25-AM, Accessory 25 EA/Case

Part Number 60417 3M Product Number 7899-25/7899-25-AM 3M ID 7000125981

Details

Disposable accessory to protect lenses from scratches, dust and overspray
Designed for use with 3M Full Facepiece 7000 Series
Recommended for painting and other spray applications
Replaceable cover easily fits over lens
Protects investment in respiratory equipment

Typical properties

Accessories
No
Brands
3M™
Case Quantity
25/pack
Clip-on Welding Shield
No
Compatible with 3M™ PAPR Systems
No
Compatible with 3M™ Supplied Air System
No
Compatible with Welding Shield
No
Cool Flow™ Exhalation Valve
No
Drop-down Feature
No

3M™ Stacked Lens Cover FF-400-18, 20 EA/Case

3M Product Number FF-400-18 3M ID 7010385198 UPC 50051141567889

Details

Includes seven removable lens cover layers to help protect the facepiece lens
Each layer easily peels away by hand as outer layer becomes clouded with overspray, dirt and residue
Peeling away contaminated layer reveals a clean layer underneath
The perimeter adhesive on the lens cover seals firmly to the lens and helps keep debris away from facepiece lens
Outer layer may be peeled away by hand while wearing respirator, limiting work stoppages to change the lens cover
Stacked lens cover system minimizes prep time when multiple lens covers are required to perform a job
System works with 3M™ Ultimate FX Full Reusable Respirators Facepiece, models FF-401, FF-402 and FF-403

Typical properties

Brands
3M™
Case Quantity
1
Compatible Respirator
FF-400 Series
Product Code
FF-400-18
Product Series
FF-400 Series
Product Type
Replacement Parts & Accessories
Recommended Application
Cleaning, Painting
Recommended Industry
Construction, Ge

3M™ Tinted Lens Cover 7986, Accessory 25 EA/BAG

3M Product Number 7986 3M ID 7000126281 UPC 50051138661880

Details

Accessory to shield eyes from bright, intense light (not for welding)
Tinting relaxes eyes to make it easier to focus on outdoor work
Designed for use with 3M Full Facepiece 7000 Series
Cover fits easily over lens
Approved 3M protection accessory

Typical properties

Accessories
No
Boxes per Case
25
Brands
3M™
Case Quantity
25/case
Clip-on Welding Shield
No
Compatible with 3M™ PAPR Systems
No
Compatible with 3M™ Supplied Air System
No
Compatible with Welding Shield
No
Cool Flow™ Exhalation Valve
No
D

3M™ SecureFit™ 500 Series Safety Glasses

Details

3M's innovative temple design features slotted ribs that provide comfortable pressure equalization, allowing the temples to flex and self-adjust to the size of the wearer's head

Curved temples apply pressure to the less sensitive back of the head, instead of the temples, achieving a comfortable fit even during rapid head movement

Sporty design with contemporary lens shape and a sleek profile

Adjustable ratchet temples allow user to adjust the lens for facial features and eyeglass position

SecureFit's flat and flexible temple design combines well with 3M™ Protective Earmuffs

Choose from models with anti-fog/anti-scratch or 3M™ Scotchgard™ Anti-Fog coating

U6 rated polycarbonate lenses absorb 99.9% of UVA, UVB, and UVC rays between 200 nm and 380 nm

Workers can feel confident wearing 3M eye protection that meets the Impact-Rated Protector requirement of the ANSI-ISEA Z87.1-2020 Standard

Typical properties

Anti Fog Lens

Yes

Brands

SecureFit™

Case Quantity

20

Class

Premium

Comfort Features

3 position lens angle adjustments, 3-position pantoscopic lens adjustment, 3M™

Pressure Diffusion Temple Technology, Adjustable lens angles, Comfortable

Wraparound

3M™ DBI-SALA® Fall Protection for Tools Belts

Details

Compatible with 3M™ DBI-SALA® Fall Protection for Tools accessories
Designed to enable users to customize their holster and pouch systems
Multiple sizes available

Typical properties

Case Quantity
1
Connected Safety ID Equipped
No
Manufacturing Origin
Taiwan
Net Weight (Metric)
0.24 kg, 0.4 kg, 0.45 kg
Product Color
Black
Product Type
Comfort Tool Belt, Utility Belt
Recommended Industry
Construction, General Industrial, M

Dimensions and Classifications

Overall Height (Metric)
43.18 mm, 69.85 mm
Overall Length (Metric)
152.4 mm, 175.26 mm

3M™ Welding Breathing Tubes

Details

Breathing Tube

Connects welding helmet to the powered air purifying respirator or supplied air unit

Increase the service life of your equipment by checking it regularly

Typical properties

Brands

Speedglas™

Breathing Tube Type

Heavy Duty, Self-Adjusting, Sound-Dampening

Case Quantity

1

Compatible Respirator

3M Adflo Powered Air Purifying Respirator

Compatible with 3M™ PAPR Systems

Yes

Compatible with 3M™ Supplied Air System

Yes

3M™ DBI-SALA® Flexiguard™ M100 Modular Jib Outrigger Base 8530873

3M Product Number 8530873 3M ID 7100252864 UPC 00648250177037

Details

- Powder coated steel upright and gusset components
- Extended rail-length increases safe working area compared to our previous jib systems
- Extended anchor height enhances capabilities in various applications compared to our previous jib systems
- Automatic mast lock helps prevent uncontrolled mast movement
- Aluminum extruded trolley rail with stainless steel / nylon trolley construction
- Rotating mast up to 360 degrees with Flip up rotation handle
- Permanent and portable mounted designs available
- Power assisted height adjustment capability for adjustable models
- Leveling jacks standard on the M100 with integrated fork pockets for transporting and positioning using industrial forklifts
- 3M™ Safety-Walk™ Slip Resistant walking surface (counterweight Bases)
- Additional system mobility with optional caster wheel kit

Typical properties

- Brands
 - DBI-SALA®
- Connected Safety ID Equipped
 - No
- Install Type
 - Temporary/Portable
- Manufacturing Origin
 - USA
- Maximum Height (Imperial)
 - 4.1 ft
- Maximum Height (Metric)
 - 1.3 m
- Maximum Number of Users
 - One
- Minimum Height (Imperial)
 - 4.1 ft
- Minimum H

Dimensions and Classifications

- Overall Height (Metric)
 - 0 mm
- Overall Length (Metric)
 - 1100 mm
- Overall Width (Metric)
 - 457 mm

3M™ Versaflo™ Headband for Premium Head Suspension S-951 1 EA/Case

Part Number 17102 3M Product Number S-951 3M ID 7000127436

Details

For use with S-950 Premium Head Suspension
Replacement Premium Head Suspension

Typical properties

Brands
Versaflo™
Compatible With
3M™ Premium Head Suspension, S-950
Headgear Type
Hood
High Heat
No
Product Color
Gray
Product Series
S-Series
Product Type
Comfort Band

3M™ Snapcap Headband Assembly W-3257, 1 EA/Case

3M Product Number W-3257 3M ID 7000131001 UPC 00051138215606

Details

For use with 3M™ Hoods H-Series

Typical properties

Brands

3M™

Compatible With

3M™ H-Series Headgear

Headgear Type

Hardhat

High Heat

No

Product Color

Transparent

Product Series

H-Series

Product Type

Comfort Band

3M™ Adjustable Hook and Loop Wristband with Retractor 1500086, 1.5 lb Capacity, Universal

3M Product Number 1500086 3M ID 7100243791 UPC 00852684933125

Details

Compatible with 3M™ DBI-SALA® Fall Protection for Tools accessories
Provides workers an attachment point to secure tools and accessories while working at height
Multiple attachment point and capacity options designed for a variety of applications

Typical properties

Brands

DBI-SALA®

Case Quantity

1

Connected Safety ID Equipped

No

Product Type

Adjustable Wristband with Retractor & Trigger Snap

Recommended Industry

Construction, General Industrial, Mining, Oil & Gas, Transportation, Utilities, Wind Energy

Wei

3M™ DBI-SALA® Adjustable Wristband with Retractor and Trigger Snap 1500087, 10/Pack

3M Product Number 1500087 3M ID 7100230429 UPC 00852684933156

Details

Compatible with 3M™ DBI-SALA® Fall Protection for Tools accessories
Provides workers an attachment point to secure tools and accessories while working at height
Multiple attachment point and capacity options designed for a variety of applications

Typical properties

Brands
DBI-SALA®
Case Quantity
10
Connected Safety ID Equipped
No
Manufacturing Origin
Taiwan
Net Weight (Metric)
1.29 kg
Product Type
Adjustable Wristband with Retractor & Trigger Snap
Recommended Industry
Construction, General Industrial, M

Dimensions and Classifications

Overall Height (Metric)
73.03 mm
Overall Length (Metric)
217.49 mm

3M™ Safety and Inspection Manager for Emergency Service, Any Level, for Restricted Customers

3M Product Number SIM-ES Restricted 3M ID 6100003704

Details

Inspect - flexibility to help you inspect anything in the firehouse such as SCBA, apparatus, turnout gear, and other equipment to ensure it is in proper working order and ready to go and help conform with NFPA 1851, NFPA 1852 and OSHA 1910.134

Simple & Scalable - web based software is prepopulated with your new 3M Scott equipment while mobile applications provide the ability to conduct workflow anywhere regardless of internet access

Assess & Plan - provides decision makers timely intelligence regarding the history, status and availability of resources and equipment with which they can plan budgetary needs

Availability - be confident in the knowledge that the equipment and resources you need are ready and waiting for deployment when called upon

Training - know the people entrusted with the task of employing the various types of safety and personal protective equipment are properly trained and fitted to execute their duties

Record keeping and traceability - on demand validation of inspections and training with insight into who, what, when, where and why the activities were completed supporting adherence to regulatory requirements

Enhanced Accountability - cloud based requiring minimal IT involvement.

Administer equipment or run reports anywhere with an internet connection. Near real-time audit trail aids in NFPA & OSHA compliance

Improved Safety - increased confidence that personnel are safe and secure using PPE that is appropriately maintained, cleaned, decontaminated, cared for and at the ready

Repair/Service - automated and individually initiated notifications alert service providers to needed and scheduled maintenance, testing or repairs; reducing the risk of failure and downtime of safety and personal protective equipment

Conforms with the most common global security requirements - the platform uses state-of-the-art access control and credentialing, user logging and encryption, and is hosted on secure cloud services

Typical properties

Brands

3M™

Product Type

Software

Recommended Application

Inspection & Asset Management

Recommended Industry

Emergency Services

Supported Mobile Devices

Refer to Technical Specification Sheet

eClass 14 Classification Group

13030200

3M™ Safety and Inspection Manager, Emergency Services, Bronze

3M Product Number SIM-ES Bronze 3M ID 6100003148

Details

Inspect - flexibility to help you inspect anything in the firehouse such as SCBA, apparatus, turnout gear, and other equipment to ensure it is in proper working order and ready to go and help conform with NFPA 1851, NFPA 1852 and OSHA 1910.134

Simple & Scalable - web based software is prepopulated with your new 3M Scott equipment while mobile applications provide the ability to conduct workflow anywhere regardless of internet access

Assess & Plan - provides decision makers timely intelligence regarding the history, status and availability of resources and equipment with which they can plan budgetary needs

Availability - be confident in the knowledge that the equipment and resources you need are ready and waiting for deployment when called upon

Training - know the people entrusted with the task of employing the various types of safety and personal protective equipment are properly trained and fitted to execute their duties

Record keeping and traceability - on demand validation of inspections and training with insight into who, what, when, where and why the activities were completed supporting adherence to regulatory requirements

Enhanced Accountability - cloud based requiring minimal IT involvement.

Administer equipment or run reports anywhere with an internet connection. Near real-time audit trail aids in NFPA & OSHA compliance

Improved Safety - increased confidence that personnel are safe and secure using PPE that is appropriately maintained, cleaned, decontaminated, cared for and at the ready

Repair/Service - automated and individually initiated notifications alert service providers to needed and scheduled maintenance, testing or repairs; reducing the risk of failure and downtime of safety and personal protective equipment

Conforms with the most common global security requirements - the platform uses state-of-the-art access control and credentialing, user logging and encryption, and is hosted on secure cloud services

Typical properties

Brands

3M™

Product Type

Software

Recommended Application

Inspection & Asset Management

Recommended Industry

Emergency Services

Supported Mobile Devices

Refer to Technical Specification Sheet

eClass 14 Classification Group

13030200

3M™ Safety and Inspection Manager, Emergency Services, Gold

3M Product Number SIM-ES Gold 3M ID 6100003150

Details

Inspect - flexibility to help you inspect anything in the firehouse such as SCBA, apparatus, turnout gear, and other equipment to ensure it is in proper working order and ready to go and help conform with NFPA 1851, NFPA 1852 and OSHA 1910.134

Simple & Scalable - web based software is prepopulated with your new 3M Scott equipment while mobile applications provide the ability to conduct workflow anywhere regardless of internet access

Assess & Plan - provides decision makers timely intelligence regarding the history, status and availability of resources and equipment with which they can plan budgetary needs

Availability - be confident in the knowledge that the equipment and resources you need are ready and waiting for deployment when called upon

Training - know the people entrusted with the task of employing the various types of safety and personal protective equipment are properly trained and fitted to execute their duties

Record keeping and traceability - on demand validation of inspections and training with insight into who, what, when, where and why the activities were completed supporting adherence to regulatory requirements

Enhanced Accountability - cloud based requiring minimal IT involvement.

Administer equipment or run reports anywhere with an internet connection. Near real-time audit trail aids in NFPA & OSHA compliance

Improved Safety - increased confidence that personnel are safe and secure using PPE that is appropriately maintained, cleaned, decontaminated, cared for and at the ready

Repair/Service - automated and individually initiated notifications alert service providers to needed and scheduled maintenance, testing or repairs; reducing the risk of failure and downtime of safety and personal protective equipment

Conforms with the most common global security requirements - the platform uses state-of-the-art access control and credentialing, user logging and encryption, and is hosted on secure cloud services

Typical properties

Brands

3M™

Product Type

Software

Recommended Application

Inspection & Asset Management

Recommended Industry

Emergency Services

Supported Mobile Devices

Refer to Technical Specification Sheet

eClass 14 Classification Group

13030200

3M™ Safety and Inspection Manager, Emergency Services, Custom

3M Product Number SIM-ES Custom 3M ID 6100003151

Details

Inspect - flexibility to help you inspect anything in the firehouse such as SCBA, apparatus, turnout gear, and other equipment to ensure it is in proper working order and ready to go and help conform with NFPA 1851, NFPA 1852 and OSHA 1910.134

Simple & Scalable - web based software is prepopulated with your new 3M Scott equipment while mobile applications provide the ability to conduct workflow anywhere regardless of internet access

Assess & Plan - provides decision makers timely intelligence regarding the history, status and availability of resources and equipment with which they can plan budgetary needs

Availability - be confident in the knowledge that the equipment and resources you need are ready and waiting for deployment when called upon

Training - know the people entrusted with the task of employing the various types of safety and personal protective equipment are properly trained and fitted to execute their duties

Record keeping and traceability - on demand validation of inspections and training with insight into who, what, when, where and why the activities were completed supporting adherence to regulatory requirements

Enhanced Accountability - cloud based requiring minimal IT involvement.

Administer equipment or run reports anywhere with an internet connection. Near real-time audit trail aids in NFPA & OSHA compliance

Improved Safety - increased confidence that personnel are safe and secure using PPE that is appropriately maintained, cleaned, decontaminated, cared for and at the ready

Repair/Service - automated and individually initiated notifications alert service providers to needed and scheduled maintenance, testing or repairs; reducing the risk of failure and downtime of safety and personal protective equipment

Conforms with the most common global security requirements - the platform uses state-of-the-art access control and credentialing, user logging and encryption, and is hosted on secure cloud services

Typical properties

Brands

3M™

Product Type

Software

Recommended Application

Inspection & Asset Management

Recommended Industry

Emergency Services

Supported Mobile Devices

Refer to Technical Specification Sheet

eClass 14 Classification Group

13030200

3M™ Safety and Inspection Manager, Emergency Services, Silver

3M Product Number SIM-ES Silver 3M ID 6100003149

Details

Inspect - flexibility to help you inspect anything in the firehouse such as SCBA, apparatus, turnout gear, and other equipment to ensure it is in proper working order and ready to go and help conform with NFPA 1851, NFPA 1852 and OSHA 1910.134

Simple & Scalable - web based software is prepopulated with your new 3M Scott equipment while mobile applications provide the ability to conduct workflow anywhere regardless of internet access

Assess & Plan - provides decision makers timely intelligence regarding the history, status and availability of resources and equipment with which they can plan budgetary needs

Availability - be confident in the knowledge that the equipment and resources you need are ready and waiting for deployment when called upon

Training - know the people entrusted with the task of employing the various types of safety and personal protective equipment are properly trained and fitted to execute their duties

Record keeping and traceability - on demand validation of inspections and training with insight into who, what, when, where and why the activities were completed supporting adherence to regulatory requirements

Enhanced Accountability - cloud based requiring minimal IT involvement.

Administer equipment or run reports anywhere with an internet connection. Near real-time audit trail aids in NFPA & OSHA compliance

Improved Safety - increased confidence that personnel are safe and secure using PPE that is appropriately maintained, cleaned, decontaminated, cared for and at the ready

Repair/Service - automated and individually initiated notifications alert service providers to needed and scheduled maintenance, testing or repairs; reducing the risk of failure and downtime of safety and personal protective equipment

Conforms with the most common global security requirements - the platform uses state-of-the-art access control and credentialing, user logging and encryption, and is hosted on secure cloud services

Typical properties

Brands

3M™

Product Type

Software

Recommended Application

Inspection & Asset Management

Recommended Industry

Emergency Services

Supported Mobile Devices

Refer to Technical Specification Sheet

eClass 14 Classification Group

13030200

3M™ DBI-SALA® FlexiGuard™ M200 Permanent Mount Base

Details

Permanently mounted design
Works optimally with all M200 series mast assemblies
Rugged powder coated steel construction

Typical properties

Connected Safety ID Equipped
No
Install Type
Permanent
Manufacturing Origin
USA
Maximum Height (Imperial)
4.6 ft, 6.6 ft
Maximum Height (Metric)
1.4 m, 2 m
Maximum Number of Users
One or Two
Minimum Height (Imperial)
4.6 ft, 6.6 ft
Minimum H

Dimensions and Classifications

Overall Height (Metric)
0 mm
Overall Length (Metric)
0 mm
Overall Width (Metric)
0 mm

3M™ Fit Test Solution

Details

Available in either sweet or a bitter taste fit test solution for fit testing
Used with the 3M™ Qualitative Fit Test Apparatus FT-10, FT-20 and/or FT-30
For Occupational Use Only

Typical properties

Case Quantity
6
Clinical Area
Surgery
Product Type
Fit Test Solution
Purpose
Parts and Accessories
Recommended Application
Fit Testing
Solution Type
Bitter, Sweet
Specifications Met
CE Approved
Test Format
Qualitative
eClass 14 Classificat

FUTURO™ Ultra Sheer Knee Highs for Women, Mild Compression

3M ID CBGBLW011016 UPC 00051131201132

Details

Mild Compression (8-15 mm/Hg)
Helps relieve symptoms of superficial spider veins or mild varicose veins
Ideal for standing or sitting all day or active office work
Reinforced toe, heel and durable run guard for lasting wear
Graduated compression helps improve circulation
Comfort band keeps knee highs from rolling down
Silky-soft material provides a comfortable feel
Great for business casual, evening and weekend wear
Made from a comfortable blend of nylon and spandex
Size: S, M, L
Color: Nude

Typical properties

Body Part
Leg
Brands
FUTURO™
Compression Level
Mild
Condition
Achy or Tired Legs, Mild Varicose Veins or Swelling
Factory ISO Certification
No ISO Certification information available
Material
Nylon, Spandex
Product Color
Nude
Product Type
S

3M™ Scott™ Pak-Tracker Firefighter Locator System

3M ID B5005270006

Details

Hand-held receiver allows for monitoring up to 36 SCBA with an active PASS alarm

Utilizes three visual and audible indicators to direct the search crew to the downed firefighter

Easy-to-use, glove-friendly, push-button operation

Automatic activation of integrated system upon SCBA air activation

High-intensity LED lights indicate battery power status, signal strength and direction

Transmitter was an optional feature on other SCBA models meeting the NFPA 1981, 2013 Edition and 2007 Edition standards

Typical properties

Brands

Scott™

eClass 14 Classification Group

13030200

3M™ Corded Reusable Earplug

3M ID CBGNAW011071 UPC 00076308147488

Details

- Pliable, tri-flange design helps provide a secure fit to help block out hazardous noise
- No roll down required helps tips stay clean even if hands are dirty
- Soft material is washable and reusable, helping to reduce waste
- Soft, smooth design for comfortable extended wear
- Easy to insert and remove
- Lightweight alternative to earmuffs
- Highly visible colors for easy location on a busy jobsite
- Great for use with additional Personal Protection Equipment (PPE)
- Noise Reduction Rating (NRR) of 25 dB*
- Helps protect against harmful noises that are at 85 dB and above
- Attached cord helps you keep track of your earplugs
- Includes a convenient case

Typical properties

- Attenuation Rating
25.0 Decibel
- Catalog Number
90716G3-DC
- Factory ISO Certification
No ISO Certification information available
- Product Type
Earplugs
- Project Applications
Installing Flooring and Trim, Laying tile, Refinishing Floors, Refinishing W

3M™ Hi-Viz Construction Vest Yellow

3M ID CBGNAW011090 UPC 10078371946170

Details

3M™ Scotchlite™ Reflective Material offers high visibility when illuminated by a light source
Five-point, tear-away construction for fast removal
360 degrees of reflectivity offers exceptional visibility on the job
Ventilated fabric helps keep you cool
Lightweight design for a comfortable fit
Neon fabric helps keep you visible during the daytime
For occupational workers who are exposed to roadway traffic and who work in an environment with moving equipment/vehicles
Interior convenient pocket holds your cell phone
Adjustable design lets you customize your fit
Designed for activities like construction, utility, school crossing and traffic direction
3M™ Safety Vest is machine washable
Intended for professional use. One size fits most
Compatible with many types of additional PPE
Class 2 vest meets the requirements of ANSI/ISEA 107-2010
Complies with the Federal Highway Mandate (2009) Manual of Uniform and Traffic Control Devices. For product questions, call 3M Product Application Support team at 1-800-494-3552

Typical properties

Factory ISO Certification
No ISO Certification information available
eClass 14 Classification Group
40010100

3M™ DBI-SALA® ExoFit™ X200 Safety Harness

Details

Revolving Torso Buckles adjust harness fit with ease and speed and lock webbing into place to maintain a comfortable and safe harness fit. Available on select models

Equipped with anti-sliding dorsal D-ring pad to help greatly reduce dorsal D-ring slide

Integrated easy-link SRL adapter lets you quickly and easily connect and disconnect personal SRLs

Dual-locking quick connect buckles lock to harness webbing and prevent adjustments from slipping

Automatic stand-up D-ring enables efficient dorsal connections

Low-profile suspension trauma strap design integrated between harness webbing

Equipped with auto-resetting lanyard keepers for fast and easy parking of snap hooks and carabiners

Equipped with an integrated RFID tag, enabling inventory, inspection, and record management

Typical properties

Belly Pad

No

Board/Seat Cushion

Yes

Board/Seat Cushion Material

Polyester

Board/Seat Hardware Material

Aluminum, Zinc Plated Steel

Board/Seat Material

Aluminum, Polyester Webbing

Body Belt

No, Yes

Body Belt Material

Polyester

Brands

DBI-SAL

3M™ Performance Reusable Paint Project Respirator OV/P95, 6211P1-DC, Size Medium, 1 each/pack, 4 packs/case

3M ID 70006985579 UPC 00051138542511

Details

NIOSH-APPROVED OV CARTRIDGE WITH P95 FILTER filters at least 95 percent of solids and liquid aerosols as well as certain organic vapors
FOR WORKPLACE/OCCUPATIONAL USE ONLY
OIL PROOF P-series particulate filter (Use according to manufacturer's time use restrictions when oil aerosols are present)
SOFT, THERMOPLASTIC FACESEAL for excellent comfort
CONVENIENT, REUSABLE DESIGN
DURABLE DESIGN for lasting wear
3M™ BAYONET CONNECTION compatible with 3M™ cartridges and filters
6001 OV CARTRIDGE HELPS REDUCE EXPOSURE to certain organic vapors encountered during activities involving latex and oil-based painting, including paint spraying*, varnishes, stains, sealants, solvents, certain solvent-based cleaners or pesticides**. *Use a prefilter when spraying **Refer to Pesticide Product Label for Respirator Guidance or call 3M at 1-800-243-4630 or In Canada, call 1-800-267-4414
5P71 FILTER HELPS REDUCE EXPOSURE to certain particles from paint spraying*, spray adhesives and pesticides**. *Use a prefilter when spraying **Refer to Pesticide Product Label for Respirator Guidance or call 3M at 1-800-243-4630 or In Canada, call 1-800-267-4414
KIT CONTENTS: one facepiece, one pair of replaceable 6001 cartridges, one pair of 501 retainers and two pairs of replaceable 5P71 filters
Replacement cartridges (6001) and filters (5P71) available for economic repeat use of the facepiece
Size: Medium
Contains no components made from natural rubber latex
WARNING: Workplace/Occupational Applications: This respirator helps protect against certain airborne contaminants. Misuse may result in sickness or death. For correct use, consult supervisor and User Instructions, or call 3M in USA at 1-800-243-4630. In Canada, call 1-800-267-4414

Typical properties

Application Type
Paint Project
Brands
3M™
Cartridge or Filter Included
Yes
Cartridge or Filter Type
Gas & Vapor
Catalog Number
6211P1-DC
Clip-on Welding Shield
No
Compatible with 3M™ PAPR Systems

No
Compatible with 3M™ Supplied Air System
Y

Dimensions and Classifications

Overall Height (Imperial)

9.5 in

Overall Height (Metric)

24.13 cm

Overall Length (Imperial)

5.4 in

Overall Length (Metric)

13.716 cm

Overall Width (Imperial)

9.4 in

Overall Width (Metric)

23.876 cm

3M™ Cool Flow™ Valve Particulate Respirator 8577 for Paint Odor

3M ID CBGNAW011201 UPC 00051131997660

Details

NIOSH-APPROVED P95 for at least 95 percent filtration efficiency against certain solid and liquid aerosols including oils

ADVANCED FILTER MEDIA for easy breathing

CARBON LAYER helps reduce nuisance levels of organic vapors such as certain solvents, degreasers, and resins*. *3M recommended for relief against nuisance level organic vapors. Nuisance levels are less than OSHA PEL or applicable government occupational exposure limits, whichever is lower

STRETCHABLE, BRAIDED HEADBAND AND SOFT INNER MATERIAL help you stay comfortable

ADJUSTABLE M-NOSECLIP helps provide a custom, secure seal with fewer pressure points

LIGHTWEIGHT DESIGN for comfort

COMFORTABLE for long periods of wear

CONVENIENT, DISPOSABLE DESIGN

RECOMMENDED FOR use with latex paints, oil-based paints, spray paint, varnish/stains* and certain pesticides** **Refer to Pesticide Product Label for Respirator Guidance or call 3M at 1-800-243-4630 or In Canada, call 1-800-267-4414

Contains no components made from natural rubber latex

DIY/Home Use: Use ONLY in NON-HARMFUL environments.

Occupational/Hazardous Use: Use under a government regulated (e.g. OSHA) respiratory protection program. WARNING: Limitations apply; Misuse may result in sickness or death. See product packaging and insert or call 3M in USA at 1-800-243-4630. In Canada, call 1-800-267-4414

Typical properties

Exhalation Valve

Yes

Factory ISO Certification

No ISO Certification information available

Filter Class

N95, P95

Product Color

White

Registered Medical Device

No

Respirator Size

Standard

Specifications Met

Assigned Protection Factor (ADF) = 10

3M™ SecureFit™ Hard Hat H-700 Series

Details

Suspension system incorporates exclusive patented Pressure Diffusion Technology

A smooth, easy turning ratchet suspension system sits low on the head to reduce pressure, helping to make 3M™ SecureFit™ Hard Hat H-700 series a comfortable and secure hard hat option

Works with a variety of 3M faceshields, earmuffs, and other accessories

Customize your fit with multiple levels of height and head-shape adjustments

Premium washable and replaceable sweatband with moisture-wicking material is designed to help keep workers cool and dry

Typical properties

Case Quantity

20

Electrical Class

C, E, G

Features

Pressure Diffusion Technology, UV Indicator

Hard Hat Type

Type I

Product Color

Black, Blue, Gray, Green, High-visibility Orange, High-visibility Yellow, Navy, Orange, Pink, Red, Tan, White, Yellow

Peltor™ Sport Tactical 300 Electronic Hearing Protector, TAC300-OTH, 1 Hearing Protector, 4/Case

3M ID 70006968948 UPC 00076308913571

Details

NRR: 24 dB noise reduction rating

IDEAL FOR both indoor and outdoor shooters and hunters

DYNAMIC SUPPRESSION TIME measures the energy in gunshot noise and automatically sets suppression time for reduced echoes and increased comfort

CLEAR VOICE TRACKING seeks voice within background noise and actively filters noise for improved speech intelligibility

DURABLE RECESSED MICROPHONES prevent damage and reduce wind noise

VENTED HEADBAND adjustable, improves comfort when worn with hats

RUNS ON 2 AA batteries (not included) or Alpha 1100 lithium ion rechargeable battery (sold separately)

Vented, adjustable headband improves comfort when worn with hats

Durable recessed microphones designed to reduce wind and fan noise

Typical properties

Battery Type

Disposable AA, Lithium-ion Rechargeable

Brands

PELTOR™

Catalog Number

TAC300-OTH

Factory ISO Certification

No ISO Certification information available

eClass 14 Classification Group

40270191

FUTURO™ Pattern Tights

3M ID CBGBLRUS1516 UPC 00051131215047

Details

Moderate Compression (15-20 mm/Hg)
Comfortable support to help promote healthy legs
Helps improve circulation, relieve swollen ankles and tired, achy legs
Great for Travel
Great for Being on Your Feet All Day
Helps prevent deep vein thrombosis (DVT)
Comfortable panty with knit-in waistband for all day comfort
Soft, silky microfiber nylon
Size M, L
Color: Black

Typical properties

Body Part
Leg
Brands
FUTURO™
Factory ISO Certification
No ISO Certification information available
Material
Nylon, Spandex
Product Color
Black
Size
Large, Medium
Sizes Available
Medium, Large
Support Level
Moderate
Support and Compression Le

3M™ Kids Hearing Protection Plus PKIDSP-TEAL, Teal, 4 ea/case

3M ID 70009119473 UPC 00638060661772

Details

Helps protect your kids' hearing, so you can enjoy loud outdoor activities together
Helps create a quiet environment for studying, reading or relaxing in shared indoor spaces

Premium hearing protection from a trusted brand in professional safety

23 dB NRR (Noise Reduction Rating)/ANSI S3.19-1974 Certified

Enhanced comfort features and durability

Padded ear cushions conform around the ears for long-lasting comfort

Flexible headband provides a secure (but not too tight) fit

Adjustable - keep using it as your child grows

Conveniently folds up into a compact size - keep it in your car or bag so it's always there when you need it

Kid-friendly design comes in a variety of fun colors and trendy patterns that kids will want to wear

Typical properties

Brands

3M™

Catalog Number

PKIDSP-TEAL

Factory ISO Certification

No ISO Certification information available

eClass 14 Classification Group

40270191

3M™ SecureFit™ Protective Eyewear SF425AF, Clear Lens, +2.5 Diopter, 20 EA/Case

3M Product Number SF425AF 3M ID 7100115329 UPC 10078371665149

Typical properties

ANSI Requirements

ANSI Z87.1-2003 and CSA Z94.3-2007

Anti Fog Lens

Yes

Brands

SecureFit™

Case Quantity

20

Class

Premium

Comfort Features

Color-accented temples, Rubber temple tips, Soft rubber nose bridge, Wide viewing area

Diopter

2.5

Eyewe

Dimensions and Classifications

Overall Height (Imperial)

5.5 in

Overall Height (Metric)

13.97 cm

Overall Length (Imperial)

5.5 in

Overall Length (Metric)

13.97 cm

Overall Width (Imperial)

2.5 in

Overall Width (Metric)

6.35 cm

3M™ SecureFit™ Protective Eyewear SF420AF, Clear Lens, +2.0 Diopter, 20 EA/Case

3M Product Number SF420AF 3M ID 7100115325 UPC 10078371665132

Typical properties

ANSI Requirements

ANSI Z87.1-2003 and CSA Z94.3-2007

Anti Fog Lens

Yes

Brands

SecureFit™

Case Quantity

20

Class

Premium

Comfort Features

Color-accented temples, Rubber temple tips, Soft rubber nose bridge, Wide viewing area

Diopter

2.0

Eyewe

Dimensions and Classifications

Overall Height (Imperial)

5.5 in

Overall Height (Metric)

13.97 cm

Overall Length (Imperial)

5.5 in

Overall Length (Metric)

13.97 cm

Overall Width (Imperial)

2.5 in

Overall Width (Metric)

6.35 cm

3M™ SecureFit™ Protective Eyewear SF415AF, Clear Lens, +1.5 Diopter, 20 EA/Case

3M Product Number SF415AF 3M ID 7100115326 UPC 10078371665125

Typical properties

ANSI Requirements

ANSI Z87.1-2003 and CSA Z94.3-2007

Anti Fog Lens

Yes

Brands

SecureFit™

Case Quantity

20

Class

Premium

Comfort Features

Color-accented temples, Rubber temple tips, Soft rubber nose bridge, Wide viewing area

Diopter

1.5

Eyewe

Dimensions and Classifications

Overall Height (Imperial)

5.5 in

Overall Height (Metric)

13.97 cm

Overall Length (Imperial)

5.5 in

Overall Length (Metric)

13.97 cm

Overall Width (Imperial)

2.5 in

Overall Width (Metric)

6.35 cm

3M™ E-A-R™ Skull Screws™ Metal Detectable Communication Ear Tips

3M Product Number MSC-YLM-25 3M ID 7100158983

Details

Ultra-soft, proprietary foam provides lasting comfort and excellent noise reduction
Helps provide clear communication in high-noise environments

Metal-detectable* stainless steel liner

For use with 3M™ PELTOR™ E-A-R buds™ Headphones (29dB), ORA TAC In-Ear Headset (29dB), and Tactical/Level Dependent Earplugs (30dB)

Disposable

One size intended to fit most

No roll down required

25 pairs/case

*Although these ear tips have been detected using multiple models of metal detection equipment, employer must ensure that 3M™ E-A-R™ Skull Screws™ Metal Detectable Communication Ear Tips are detected with their equipment prior to approving them for use at their facility

Typical properties

Banded

No

Brands

E-A-R™

Corded

No

Hearing Protection Type

In-Ear

Intrinsically Safe

No

Product Color

Yellow

Product Type

Communication Eartip

Reusable

Yes

eClass 14 Classification Group

40270191

3M™ PELTOR™ Remote Control Unit RCU-300N/A, 1 ea/Case

3M Product Number RCU-300NA/1 3M ID 7100223515 UPC 07318640070691

Details

Used for remote operation of the SCU. Includes PTT and volume controls
Designed to be mounted on a picatinny rail, or it can also be placed elsewhere (e.g. steering wheel, second body location)
Buttons: Easy to find. Easy to Identify. Easy to Press
1600 Hour Battery life (2 replaceable coin cell batteries)
Up to 2 RCUs can be paired to SCU simultaneously
Small (L:2.4" W: 1.6" H: 1")
Lightweight (1.8 oz)

Typical properties

Battery Life
Approx. 1600 hr
Battery Type
Button Cell
Brands
PELTOR™
Case Quantity
1
Compatible Radio Brands
PELTOR
Compatible With
ComTac VII Headset, SCU-300 System Control Unit, TEP-300 Tactical Earplug
Product Color
Gray
Product Type
Re

3M™ Health, Safety and Compliance Software Implementation, Classic

3M Product Number SIM-TRN-CLASSIC 3M ID 6100003505

Details

Specialized training to expedite ROI and system adoption
We'll work with you to quickly setup your account, help you define checklists, and help you to begin to tag assets and conduct inspections
Learn best practices and help ensure proper implementation
Travel included for most locations

Typical properties

Brands
3M™
Recommended Application
Connected Safety
Recommended Industry
Construction, Food & Beverage
eClass 14 Classification Group
25250000

3M™ Health, Safety and Compliance Software Implementation, Pro

3M Product Number SIM-TRN-PRO 3M ID 6100003506

Details

Specialized training to expedite ROI and system adoption
We'll work with you to quickly setup your account, help you define checklists, and help you to begin to tag assets and conduct inspections
Learn best practices and help ensure proper implementation
Travel included for most locations

Typical properties

Brands
3M™
Recommended Application
Connected Safety
Recommended Industry
Construction, Food & Beverage
eClass 14 Classification Group
25250000

3M™ DBI-SALA® Lineman Belts

Details

Uniquely designed to move user's center of gravity upward
Rolled leather edges add durability and comfort at the hips
Tongue buckle style body belt allows for simplified sizing adjustments

Typical properties

Board/Seat Cushion
No, Yes
Brands
DBI-SALA®
Buckle Material
Zinc Plated Steel
Buckle Type
Dual Lock Quick Connect, Tongue Buckle
D-ring Material
Zinc Plated Steel
D-ring Placement
Side
Hip Pad
Yes
Material
Leather/Nylon
Product Color
Blac

3M™ DBI-SALA® Confined Space Aluminum Tripod with 3-Way SRL 8301097, 9 ft Tripod, 50 ft Galvanized Cable

3M Product Number 8301097 3M ID 7100327877 UPC 00648250257845

Details

Includes 3-Way SRL

Available in 7 ft. (2.1 m) and 9 ft. (2.7 m)

Cable available in stainless steel and galvanized

Tripod is of aluminum construction

Available with multiple SRL combinations

Eye Bolt Material Handling Weight Capacity: 1000 lb (453 kg)

Mounting Bracket Material Handling Weight Capacity: 620 lb (281 kg)

Typical properties

Brands

DBI-SALA®

Carabiner/Hook Material

Zinc Plated Steel

Connected Safety ID Equipped

Yes

Install Type

Portable

Lifeline Length (Imperial)

50 ft

Lifeline Length (Metric)

15.2 m

Lifeline Material

Galvanized Cable

Product Color

Silver

Prod

Dimensions and Classifications

Overall Height (Imperial)

9 ft

Overall Height (Metric)

2.7 m

3M™ DBI-SALA® Confined Space Aluminum Tripod with 3-Way SRL 8301094, 9 ft Tripod, 50 ft Stainless Steel Cable

3M Product Number 8301094 3M ID 7100327874 UPC 00648250257814

Details

Includes 3-Way SRL
Available in 7 ft. (2.1 m) and 9 ft. (2.7 m)
Cable available in stainless steel and galvanized
Tripod is of aluminum construction
Available with multiple SRL combinations
Eye Bolt Material Handling Weight Capacity: 1000 lb (453 kg)
Mounting Bracket Material Handling Weight Capacity: 620 lb (281 kg)

Typical properties

Brands
DBI-SALA®
Carabiner/Hook Material
Zinc Plated Steel
Connected Safety ID Equipped
Yes
Install Type
Portable
Lifeline Length (Imperial)
50 ft
Lifeline Length (Metric)
15.2 m
Lifeline Material
Stainless Steel Cable
Product Color
Silver

Dimensions and Classifications

Overall Height (Imperial)
9 ft
Overall Height (Metric)
2.7 m

3M™ DBI-SALA® Confined Space Aluminum Tripod with 3-Way SRL 8301091, 7 ft Tripod, 50 ft Galvanized Cable

3M Product Number 8301091 3M ID 7100327872 UPC 00648250257784

Details

Includes 3-Way SRL
Available in 7 ft. (2.1 m) and 9 ft. (2.7 m)
Cable available in stainless steel and galvanized
Tripod is of aluminum construction
Available with multiple SRL combinations
Eye Bolt Material Handling Weight Capacity: 1000 lb (453 kg)
Mounting Bracket Material Handling Weight Capacity: 620 lb (281 kg)

Typical properties

Brands
DBI-SALA®
Carabiner/Hook Material
Zinc Plated Steel
Connected Safety ID Equipped
Yes
Install Type
Portable
Lifeline Length (Imperial)
50 ft
Lifeline Length (Metric)
15.2 m
Lifeline Material
Galvanized Cable
Product Color
Silver
Prod

Dimensions and Classifications

Overall Height (Imperial)
7 ft
Overall Height (Metric)
2.13 m

3M™ DBI-SALA® Confined Space Aluminum Tripod with 3-Way SRL 8301089, 7 ft Tripod, 50 ft Stainless Steel Cable

3M Product Number 8301089 3M ID 7100327870 UPC 00648250257760

Details

Includes 3-Way SRL

Available in 7 ft. (2.1 m) and 9 ft. (2.7 m)

Cable available in stainless steel and galvanized

Tripod is of aluminum construction

Available with multiple SRL combinations

Eye Bolt Material Handling Weight Capacity: 1000 lb (453 kg)

Mounting Bracket Material Handling Weight Capacity: 620 lb (281 kg)

Typical properties

Brands

DBI-SALA®

Carabiner/Hook Material

Zinc Plated Steel

Connected Safety ID Equipped

Yes

Install Type

Portable

Lifeline Length (Imperial)

50 ft

Lifeline Length (Metric)

15.2 m

Lifeline Material

Stainless Steel Cable

Product Color

Silver

Dimensions and Classifications

Overall Height (Imperial)

7 ft

Overall Height (Metric)

2.13 m

3M™ DBI-SALA® Confined Space Aluminum Tripod with 3-Way SRL 8301090, 7 ft Tripod, 50 ft Galvanized Cable

3M Product Number 8301090 3M ID 7100327871 UPC 00648250257777

Details

Includes 3-Way SRL

Available in 7 ft. (2.1 m) and 9 ft. (2.7 m)

Cable available in stainless steel and galvanized

Tripod is of aluminum construction

Available with multiple SRL combinations

Eye Bolt Material Handling Weight Capacity: 1000 lb (453 kg)

Mounting Bracket Material Handling Weight Capacity: 620 lb (281 kg)

Typical properties

Brands

DBI-SALA®

Carabiner/Hook Material

Zinc Plated Steel

Connected Safety ID Equipped

Yes

Install Type

Portable

Lifeline Length (Imperial)

50 ft

Lifeline Length (Metric)

15.2 m

Lifeline Material

Galvanized Cable

Product Color

Silver

Prod

Dimensions and Classifications

Overall Height (Imperial)

7 ft

Overall Height (Metric)

2.13 m

3M™ DBI-SALA® Confined Space Aluminum Tripod with 3-Way SRL 8301098, 50 ft. (15.2 m) Galvanized Cable

3M Product Number 8301098 3M ID 7100327878 UPC 00648250257852

Details

Includes 3-Way SRL
Available in 7 ft. (2.1 m) and 9 ft. (2.7 m)
Cable available in stainless steel and galvanized
Tripod is of aluminum construction
Available with multiple SRL combinations
Eye Bolt Material Handling Weight Capacity: 1000 lb (453 kg)
Mounting Bracket Material Handling Weight Capacity: 620 lb (281 kg)

Typical properties

Brands
DBI-SALA®
Carabiner/Hook Material
Zinc Plated Steel
Connected Safety ID Equipped
Yes
Install Type
Portable
Lifeline Length (Imperial)
85 ft
Lifeline Length (Metric)
15.2 m
Lifeline Material
Galvanized Cable
Product Color
Silver
Prod

Dimensions and Classifications

Overall Height (Imperial)
7 ft
Overall Height (Metric)
2.13 m

3M™ Versaflo™ TR-300+ Series PAPR Systems

Details

Slim, lightweight unit is well-balanced and comfortable to wear for long work shifts

Two user selectable airflows enable the user to control flow settings to allow the user to find the setting they find most comfortable

Blowers automatically adjust airflow to compensate for filter loading to deliver consistent filtered air during use

Audible and visual alerts for low airflow and low battery charge-level to keep you prepared and informed

Able to be worn in a belt or backpack

Available in convenient, easy to buy assemblies and kits

Typical properties

Battery Life

10 - 12 Hours, 6 hr, 8 hr - 12 hr

Battery Type

High Capacity Lithium Ion - Rechargeable, None

Belt Type

Easy Clean, High Durability, None

Brands

Versaflo™

Breathing Tube Type

Back-Mounted, Belt-mounted

Cartridge or Filter Included

3M™ Performance Particulate Respirator 8210

3M ID CBGNAW011086 UPC 00051111112205

Details

NIOSH-APPROVED N95 for at least 95 percent filtration efficiency against certain non-oil-based particles and aerosols
ADVANCED FILTER MEDIA for easy breathing
CUSHIONING NOSE FOAM rests on bridge of nose for comfort
ADJUSTABLE NOSECLIP helps ensure a custom, secure seal
STRETCHABLE STRAPS
LIGHTWEIGHT DESIGN for comfort
CONVENIENT, DISPOSABLE DESIGN
RECOMMENDED FOR use when sanding, sawing, grinding, lawn mowing, sweeping, drywall sanding, grinding, woodworking and working with fiberglass insulating particles
ALSO HELPS PROTECT AGAINST: certain particles such as mold, granular pesticides, allergens and dust
Contains no components made from natural rubber latex
Available in multiple package quantities
DIY/Home Use: Use ONLY in NON-HARMFUL environments.
Occupational/Hazardous Use: Use under a government regulated (e.g. OSHA) respiratory protection program. WARNING: Limitations apply; Misuse may result in sickness or death. See product packaging and insert or call 3M in USA at 1-800-243-4630. In Canada, call 1-800-267-4414

Typical properties

Cool Flow™ Exhalation Valve
No
Enhanced Comfort
No
Enhanced Durability
No
Exhalation Valve
No
Faceseal
Yes
Factory ISO Certification
No ISO Certification information available
Filter Class
N95, P95
Hazard Type
Fiberglass, Sanding, Woodworki

3M™ Folding Earmuff, 90563H1-DC, Black, 5 earmuff/case

3M ID 70006983202 UPC 00076308906443

Details

Noise Reduction Rating (NRR) of 25 dB*

Helps protect against harmful noises

Padded headband for comfort

Pivoting cups to help ensure a good fit

Folds up neatly for compact storage when not in use

Helps lower your risk of noise-induced hearing loss

Flexible, adjustable headband adjusts for multiple head sizes

Great for use in noisy workshops, factories, construction sites and during landscaping

Reusable hearing protection

*CAUTION: 3M strongly recommends fit testing of hearing protectors. Research suggests that many users will receive less noise reduction than indicated by the NRR due to variation in hearing protector fit, fitting skill and motivation of the user. If the NRR is used, 3M recommends that it be reduced by 50% or in accordance with applicable regulations

Typical properties

Bluetooth

No

Brands

3M™

Built In FM and or AM Radio

No

Catalog Number

90563H1-DC

Earmuff Style

Folding/Over the Head

Factory ISO Certification

No ISO Certification information available

Recommended Application

Construction, Facility Maintenance

Dimensions and Classifications

Overall Height (Imperial)

10.236 in

Overall Length (Imperial)

7.48 in

Overall Width (Imperial)

4 in

Peltor™ Sport Blasts™ Corded Disposable Earplugs 97081-10C, 2 Pair Pack, Neon Yellow

3M ID 70006944931 UPC 00078371970819

Details

Peltor Sport's highest Noise Reduction Rating (NRR) earplug at 32 dB
Soft foam expands slowly to fit comfortably
2-pair pack includes storage container to help keep plugs clean when not being worn
Easy to insert and remove
Cord helps reduce the chance of loss when not in use
Made in U.S.A. with globally sourced materials

Typical properties

Brands
PELTOR™
Catalog Number
97081-10C
Factory ISO Certification
No ISO Certification information available
eClass 14 Classification Group
40270190

3M™ SecureFit™ 400 Indoor/Outdoor Eye Protection SF400M-WV-6-PS, Mirror, Anti-Scratch

3M ID 70006963410 UPC 00076308724023

Details

Durable lenses help provide limited protection from light to moderate impact hazards

3M™ Pressure Diffusion Temple self-adjusts to provide a secure, comfortable fit

Padded temples for added comfort over the ears

Soft, conformable nose pads provide customizable comfort

Lightweight, durable design for all-day comfort and lasting wear

Sleek temples create a flush fit with ear protection

Flexible temples conform comfortably to different head sizes

Anti-fog, scratch-resistant lenses help keep vision clear

Impact-resistant lenses block 99.9% of UV rays

Meets the requirements of ANSI Z87.1, CSA Z94.3 and AS/NZS 1337

Mirrored lenses help reduce glare and are popular for indoor/outdoor use

Typical properties

ANSI Requirements

ANSI Z87.1-2010

Anti Fog Lens

Yes

Brands

SecureFit™

Catalog Number

SF400M-WV-6-PS

Factory ISO Certification

No ISO Certification information available

Frame Color

Neon Green/Black

Frame Material

Polycarbonate

Frame Style

W

Dimensions and Classifications

Overall Height (Imperial)

10.05 in

Overall Height (Metric)

255.27 mm

Overall Length (Imperial)

5 in

Overall Length (Metric)

127 mm

Overall Width (Imperial)

6.9 in

FUTURO™ Business Casual Socks for Men, Pattern

3M ID CBGBLRUS1534 UPC 00051131215085

Details

Moderate Compression (15-20 mm/Hg)
Comfortable support to help promote healthy legs
Helps improve circulation, relieve swollen ankles and tired, achy legs
Great for Travel
Great for Being on Your Feet All Day
Helps prevent deep vein thrombosis (DVT)
Wide top band for comfort
Reciprocated heel and toe for great fit
Size M, L
Color: Black

Typical properties

Body Part
Leg
Brands
FUTURO™
Factory ISO Certification
No ISO Certification information available
Material
Nylon, Polyester, Spandex
Product Color
Black
Product Type
Socks
Size
Large, Medium
Sizes Available
Medium, Large
Support Level
Mod

FUTURO™ Trouser Socks for Women, Mild Compression

3M ID CBGBLW011015 UPC 00051131201491

Details

Mild Compression (8-15 mm/Hg)
Vein therapy helps relieve symptoms of mild varicose veins and swelling
Ideal for standing or sitting all day or active office work
Massages tired, achy legs as you move
Graduated compression helps improve circulation
Attractive, wide band holds socks in place
Great for business casual and weekend wear
Balloon toe and reciprocated heel for soft comfort
Made from a comfortable blend of nylon and spandex
Size: M, L
Color: Black

Typical properties

Body Part
Leg
Brands
FUTURO™
Compression Level
Mild
Condition
Achy or Tired Legs, Mild Varicose Veins or Swelling
Factory ISO Certification
No ISO Certification information available
Material
Nylon, Spandex
Product Color
Black
Product Type

3M™ Hard Hat with Ratchet Adjustment White

3M ID CBGNAW011112 UPC 00078371912970

Details

Ratchet adjustment for custom, on-head sizing
Three levels of height adjustment promote optimal comfort
Suspension system sits lower on your head to reduce pressure points
Low-profile design enhances stability for balanced comfort
Short brim is great for upward visibility
Breathable, foam brow pad enhances comfort
Compliant with ANSI/ISEA requirements when worn in forward and back facing positions
Meets the requirements of ANSI/ISEA Z89.1 Type 1, Class G and E
Meets the requirements of CSA Z94.1 Type 1, Class G and E
Clean your hard hat with mild soap and water
Color: White
Package contents: 1 Hard Hat
For product questions, call 3M Product Application Support team at 1-800-494-3552

Typical properties

Electrical Class
C, E, G
Factory ISO Certification
No ISO Certification information available
Hard Hat Type
Type I
Product Type
Front Brim Hard Hat
Shell Material
HDPE
Specifications Met
ANSI Z89.1-2003
Suspension Type
4 Point Ratchet
Sweatband

Dimensions and Classifications

Overall Height (Imperial)
7 in
Overall Height (Metric)
17.78 cm
Overall Length (Imperial)
11 in
Overall Length (Metric)
27.94 cm
Overall Width (Imperial)
8.5 in

ACE™ Brand Compression Knee Sleeve with Pad

3M ID CBGBLRUS1498 UPC 00051131194106

Details

Anatomical design conforms to your knee for comfort, fit and compression

Ideal for sore, weak and injured knees

Strategically placed EVA closed cell foam pad helps protect your knee from impact and scrapes while the flexible hex pattern promotes natural mobility

Breathable material for cooling comfort

Smooth edges help reduce chafing and resist slipping and rolling

Conforms to either knee

Sleeve design is easy to put on and take off

Ideal for sports like basketball, volleyball, football, and more

Sleek design for a modern look

Hand wash in warm water with mild soap

Size: S/M & L/XL

ACE is America's most trusted brand of braces, supports and elastic bandages (Based on 2015 TNS Brand Health tracking of braces, supports and elastic bandages.)

Designed and developed in collaboration with Sports Medicine professionals

Typical properties

Body Part

Knee

Brands

ACE™

Factory ISO Certification

No ISO Certification information available

Fit Range

S/M fits: 12" to 14.5"
L/XL fits: 14.5" to 17"

Foot Style

Closed Toe

Product Color

Black

Product Type

Support

Size

Large/X-Large,

3M™ Anti-Fog Goggle with Scotchgard™ Protector 47210H1-VDC-PS, Black/Blue, Clear Lens, 5/cs

3M ID 70009111116 UPC 00638060280768

Details

Give you and your crew the essential protection and undeniable style of 3M™ Performance Eyewear
PREMIUM ANTI-FOG COATING to help you see clearly for longer
DURABLE LENSES help provide limited protection from light to moderate impact hazards
LIGHTWEIGHT, durable design for comfort and lasting use
DESIGNED FOR WORKING in challenging situations such as heat and humidity, indoor, outdoor and climate-controlled areas
COMPATIBLE with many types of additional Personal Protection Equipment (PPE)
SOFT TOUCH nose pads and earpiece enhance comfort
SCRATCH RESISTANT lenses help keep vision clear
IMPACT RESISTANT LENSES block 99.9% of UV rays
Meets the requirements of ANSI Z87.1 , CSA Z94.3 and AS/NZS 1337
CLEAR LENSES help provide excellent visibility and can be used indoors or outdoors

Typical properties

Brands
3M™
Catalog Number
47210H1-VDC-PS
Factory ISO Certification
No ISO Certification information available
eClass 14 Classification Group
40230101

Peltor™ Sport SecureFit™ Safety Eyewear SF400-PA-9, Amber/AF Lens

3M ID CBGBLRUS1538 UPC 00638060267226

Details

Lightweight, Flat-Temple, Low-Profile Design Works Seamlessly With Hearing Protection
Wear All Day - Forget You Have Them On
Padded Temples For Added Comfort Over The Ears
Soft, Conformable Nose Pads Provide Customizable Comfort
Lightweight, Durable Design For All-Day Comfort And Lasting Wear
Flexible Temples Conform Comfortably To Different Head Sizes
Anti-Fog, Scratch-Resistant Lenses Help Keep Vision Clear
Impact-Resistant Lenses Block 99.9% Of Uv Rays
Meets The Requirements Of Ansi Z87.1, Csa Z94.3 And As/Nzs 1337
Amber Lenses Enhance Contrast In Low Light Conditions
Also Available In Clear Lenses For Excellent Visibility Both Indoors And Outdoors
Includes: 1 Per Pack

Typical properties

Catalog Number
SF400-PA-9
Factory ISO Certification
No ISO Certification information available
Frame Color
Black and Green
Lens Color
Amber
eClass 14 Classification Group
40230101

3M™ Protecta® Web Tie-Off Adapter Anchor

Details

Lightweight and durable polyester web construction
Meets the requirements for 29 CFR OSHA 1910.140, and OSHA 1926.502
Recommended for use in multiple industries including construction, mining, oil and gas, transportation, utilities, and wind energy
Adjustable designs available to accommodate a variety of different sized structures
Compatible with various fall arrest systems
This safety equipment is designed for use with additional personal fall arrest systems
Features high-strength steel hardware
Portable and reusable
Ideal anchorage device for scaffolding or piping
3 ft. (0.9 m) pass-thru type tie-off adaptor
Abrasion resistant polyester wear pad

Typical properties

Anchor Install Type
Reusable
Attachment Type
Pass-through/Choker
Case Quantity
1
Connected Safety ID Equipped
No
Install Type
Reusable
Material
Polyester Web
Product Color
Red
Product Series
PRO™
Product Type
Tie-off Adaptor, Web Tie-Off

Dimensions and Classifications

Overall Length (Imperial)
8 ft, 16 ft, 20 ft

3M™ Scotchlite™ Reflective Material 8940 Series

Details

3M™ Scotchlite™ Reflective Material is designed for enhancing visibility in low light and nighttime conditions
Certified to various global high visibility standards such as ANSI/ISEA 107
Certified to various flame resistant standards such as NFPA
Suitable for applications that will be exposed to industrial laundering
Sew-on application

Typical properties

Adhesive
None
Attachment Type
Sew On
Backing
None
Backing Material
Aramid
Brands
Scotchlite™
Certified Performance Required
ANSI 107-2015, CGSB, CSA Z95-2015, NFPA
Daytime Color
Silver
Dry-Cleaning Cycles at ANSI Certified Standards
30
Dry

Dimensions and Classifications

Overall Length (Imperial)
54.68 yd, 109.36 yd, 218.72 yd
Overall Length (Metric)
50 m, 100 m, 200 m
Overall Width (Imperial)
0.5 in, 1 in, 2 in, 3 in, 36 in, 50 in
Overall Width (Metric)
12.7 mm, 19.05 mm, 25.4 mm, 50.8 mm, 914.4 mm, 1270 mm

3M™ Scotchlite™ Reflective Material 9925, Silver Industrial Wash Fabric, Roll, Config

3M Product Number 9925 3M ID 7100121735

Details

3M™ Scotchlite™ Reflective Material is designed for enhancing visibility in low light and nighttime conditions
Certified to ISO 20471 high visibility standard
Suitable for applications that will be exposed to industrial laundering
Sew-on application
50 disinfectant wash cycles per ISO 15797-2

Typical properties

Adhesive
None
Adhesive Side Liner
None
Attachment Type
Sew On
Backing
100% Polyester Fabric
Backing Material
Polyester
Brands
Scotchlite™
Certified Performance Required
ANSI 107-2015, Oeko-Tex
Configurable
Yes
Daytime Color
Silver
Dry-Cl

3M™ 1100 Earplugs

Details

Made with soft foam

Soft foam helps conform to the shape of the ear canal for a comfortable, snug fit

Compatible with the 3M™ E-A-Rfit™ Validation System

Dispenser packaging option available for uncorded earplugs

CSA Class AL

One size fits most

*U.S. EPA specifies the NRR as the measure of hearing protector noise reduction. However, 3M makes no warranties as to the suitability of the NRR for this purpose. 3M strongly recommends personal fit testing of hearing protectors. Research suggests that users may receive less noise reduction than indicated by the attenuation label value(s) on the packaging due to variation in fit, fitting skill, and motivation of the user. Refer to applicable regulations or guidance on how to adjust attenuation label values. It is recommended that the NRR be reduced by 50% to better estimate typical protection

Typical properties

Attenuation Rating

29.0 Decibel

Attenuation Rating (SNR)

37 Decibel

Banded

No

Case Quantity

1000 Pair, 2000 Pair, 500 Pair

Cord Color

Red

Cord Material

Cloth

Cord Type

None

Corded

No, Yes

Dielectric

No, Yes

Dispenser Available

No, Yes

Ea

3M™ PELTOR™ Adapters

Details

Assortment for selected 2-way communication radios
Compatible with various 3M™ PELTOR™ Communication Headsets

Typical properties

Auxiliary Port
J11, NEXUS® TP-120, NEXUS® TP-120 (NATO)
Battery Life
Approx. 29 hours
Battery Type
AA or Rechargeable NiMH Pack, Disposable AA
Bluetooth
Yes
Case Quantity
1,1 EA/CS,20 ea / cs,10
Communication Type
Bluetooth, Push-to-Talk Adapte

3M™ PELTOR™ Rechargeable Battery ACK053 for Lite-Com BRS Headsets, 1 EA/Case

3M Product Number ACK053 3M ID 7100075338 UPC 07318640063846

Details

Rechargeable NiMH Battery Pack

For use with the 3M™ PELTOR™ WS Headset XP, WS Ground Mech, WS ProTac XP, and LiteCom BRS Headsets

For use with the 3M™ PELTOR™ FL6000 series Bluetooth® Adapters
1 each/case

Typical properties

Battery Life

Approx. 20 hours

Battery Type

AA or Rechargeable NiMH Pack

Brands

PELTOR™

Case Quantity

100

Intrinsically Safe

No

Product Color

Black

Product Series

Lite-Com

Product Type

Battery

Recommended Industry

Agriculture

eClass 14 CI

3M™ PELTOR™ Rechargeable Battery, ACK081, 1 EA/Case

3M Product Number ACK081 3M ID 7100075380 UPC 07318640063730

Details

Rechargeable Lithium-Ion Battery Pack
For use with the 3M™ PELTOR™ LiteCom Plus Headsets
1 each/case

Typical properties

Battery Life
Approx. 20 hours
Battery Type
Rechargeable Li-ion Pack
Brands
PELTOR™
Case Quantity
48
Intrinsically Safe
No
Product Color
Black
Product Type
Battery
eClass 14 Classification Group
40270191

3M™ Peltor™ Rechargeable Battery Pack, 88009-00000, 1 ea/cs

3M Product Number 88009-00000 3M ID 7000052756 UPC 00093045880096

Details

3M Peltor Rechargeable Battery Pack

Complete with one wall transformer and one battery pack

2.4 Volts, 1200mAh

Ni-MH battery pack

Compatible with Alert, Workstyle, TacticalPRO, PowerCom, PowerComPLUS,
LiteCom series headsets 3M is Leading the Advancement of Hearing

Conservation(TM)

Complete with one wall transformer and one battery pack

2.4 Volts, 1200mAh

Ni-MH battery pack

Compatible with Alert, Workstyle, TacticalPRO, PowerCom, PowerComPLUS,
LiteCom series headsets

Typical properties

Brands

PELTOR™

Product Type

Battery Pack

eClass 14 Classification Group

40270191

3M™ DBI-SALA® Confined Space Adjustable Offset Upper Davit Mast

Details

Integrated 5,000 lb. (22 kN) mast anchorage point
Depending on davit base, rated for fall arrest in different davit offset mast positions
Depending on davit base, can be combined with one or two lower mast extensions to increase overall height
Available in two extension ranges: 11.5 in. to 27.5 in. (29.2 cm to 69.8 cm), and 23.5 in. to 42.5 in. (59.7 cm to 108 cm)
Recommended for use in many industries
Adjustable vertical height
Integrated secondary fall arrest anchorage point
For use with portable and permanent bases

Typical properties

Case Quantity
1
Connected Safety ID Equipped
No
For Use With
Lower Extensions
Install Type
Portable
Net Weight (Imperial)
26.1 lb, 31.1 lb
Net Weight (Metric)
11.8 kg, 14.1 kg
Product Color
Green, Silver
Product Series
Advanced™
Product Ty

Dimensions and Classifications

Overall Height (Imperial)
51.1 in, 67.55 in
Overall Height (Metric)
129.79 cm, 171.58 cm

3M™ DBI-SALA® Rollgliss™ R550 Rescue and Descent Device

Details

Attaches Rollgliss™ R550 Rescue and Descent Device to ladder rungs
Fast and simple detent-style mounting of R550 to bracket
Built-in adjustment handle for various rung spacing
Detent pin installs ladder to bracket
Powder-coated steel construction for durability and strength
Recommended for use in transportation, utilities, and general industrial applications
2.5 lb. (1.1 kg) bracket with 310 lb. (140.6 kg) weight capacity
Rescue wheel available on some models. Constructed of Supertough® nylon, this rescue wheel is ergonomically designed to provide control and reliability
Fully sealed humidity case included on certain models or available for purchase as an add on, provides 10 year minimum storage life. External humidity indicator allows user to inspect the seal without opening case

Typical properties

Brands
DBI-SALA®
Carabiner/Hook Material
Aluminum, Zinc Plated Steel
Case Quantity
1
CoWorker Controlled Ascent
No, Yes
CoWorker Controlled Descent
No, Yes
Connected Safety ID Equipped
No, Yes
Descent Type
Vertical
Housing Material
Aluminum

Dimensions and Classifications

Overall Length (Imperial)
25 ft, 50 ft, 75 ft, 100 ft, 150 ft, 175 ft, 200 ft, 250 ft, 275 ft, 300 ft, 325 ft, 350 ft,
361 ft, 400 ft, 450 ft, 500 ft, 600 ft, 700 ft, 1000 ft, 1200 ft, 1600 ft
Overall Length (Metric)
8 m, 15 m, 23 m, 30 m, 46 m, 53 m,

3M™ Nebulizer FT-13, 3 EA/Case

3M Product Number FT-13 3M ID 7000001897 UPC 50051138163575

Details

A replacement part for 3M™ Qualitative Fit Test Apparatus Kits FT-10 Sweet and FT-30 Bitter

Fast, easy method for performing qualitative fit testing

Can be used to check face-to-respirator seal on any particulate respirator or gas/vapor respirator with a particulate prefilter

For Occupational Use Only

Typical properties

Brands

3M™

Case Quantity

3

Clinical Area

Surgery

Product Type

Nebulizer

Purpose

Parts and Accessories

Recommended Application

Fit Testing

Specifications Met

CE Approved

Test Format

Qualitative

eClass 14 Classification Group

40220190

3M™ Tour-Guard™ III Safety Overspectacles

Details

Economical eyewear provides impact protection to site visitors or for general use
Integral side shields offer full coverage and extra protection
Clear lenses provide unobstructed viewing
Designed to fit over most prescription glasses and sunglasses
Meets the Impact-Rated Protector requirement of the ANSI-ISEA Z87.1-2020 Standard
Polycarbonate lens absorbs 99.9% of harmful UVA and UVB rays
Includes a convenient dispenser box

Typical properties

ANSI Requirements
ANSI Z87.1-2003 and CSA Z94.3-2007
Anti Fog Lens
Yes
Case Quantity
100,5
Class
Economy
Comfort Features
Impact Protection, Integrated sideshields, Over-the glass coverage
Eyewear Range
Economy
Frame Color
Clear
Frame Materi

Dimensions and Classifications

Overall Height (Imperial)
6.5 in, 7.5 in
Overall Height (Metric)
16.51 cm, 19.05 cm
Overall Length (Imperial)
6.5 in, 7.5 in
Overall Length (Metric)
16.51 cm, 19.05 cm
Overall Width (Imperial)
2.25 in, 5.5 in
Overall Width (Metric)
5.715 cm, 13

3M™ GoggleGear™ 500-Series Replacement Neoprene Strap, 10 EA/Case

3M Product Number GG500-NeoStrap 3M ID 7010316627 UPC 50051131275602

Details

Fits Goggle Gear 500 series

Neoprene replacement strap

3M™ Goggle Gear, 500-Series is a low-profile design with an adjustable strap and indirect ventilation

These splash goggles with 3M™ Scotchgard™ Anti-Fog Coating help keep lenses clear in, steamy and wet environments

Typical properties

3M Technology

Scotchgard Anti-Fog Coating

Brands

GoggleGear™

Comfort Features

Neoprene Strap

Product Type

Replacement Strap

Strap Material

Neoprene

eClass 14 Classification Group

40230191

3M™ GoggleGear™ 500-Series Replacement Cloth Strap, 10 EA/Case

3M Product Number GG500-ClthStrap 3M ID 7010341344 UPC 50051131275626

Details

Fits Goggle Gear 500 series

Cloth Replacement Strap

3M™ Goggle Gear, 500-Series is a low-profile design with an adjustable strap and indirect ventilation

These splash goggles with 3M™ Scotchgard™ Anti-Fog Coating help keep lenses clear in, steamy and wet environments

Typical properties

3M Technology

Scotchgard Anti-Fog Coating

Brands

GoggleGear™

Comfort Features

Elastic Strap

Product Type

Replacement Strap

eClass 14 Classification Group

40230191

3M™ DBI-SALA® Flexiguard™ A-Frame Rail Adjustable Height Anchor System 8517781, 2 User, Yellow, 16 - 22.5 ft Height, 30 ft Width

Part Number 8517781 3M Product Number 8517781 3M ID 7100231969

Details

Multiple height and width configurations available
Aluminum and steel construction
Extruded aluminum rail requires minimal maintenance and includes two trolleys
System includes steel leveling jacks
Conforms to the requirements of OSHA 1926.502 and OSHA 1910.66
Suitable for numerous applications within the transportation, construction, utilities, and mining industries

Typical properties

Brands
DBI-SALA®
Case Quantity
1
Connected Safety ID Equipped
Yes
Install Type
Temporary/Portable
Maximum Height (Imperial)
24.38 ft
Maximum Height (Metric)
7.43 m
Maximum Number of Users
Two
Product Color
Silver, Yellow
Product Series
FI

Dimensions and Classifications

Overall Width (Imperial)
34.06 ft
Overall Width (Metric)
10.38 m

3M™ Quick Release Locking Detent Pin 9503317, 5/16 in x 3.7 in

3M Product Number 9503317 3M ID 7100312867

Details

Rugged and corrosion resistant material construction for durability with compact and lightweight design

Use vertically in wall or horizontally in ceiling (both components)

High strength steel construction

Compatible with various fall arrest systems

Meets the requirements for 29 CFR OSHA 1910.140, and OSHA 1926.502

Recommended for use in the construction, general industrial, mining, oil and gas, and utilities industries

This safety equipment is designed for use with additional personal fall protection systems (PPE)

Detent pin for use with 2101000 concrete socket

Swiveling D-ring tie-off point

Typical properties

Brands

3M™

3M™ Integrated Protective Eyewear

Details

Connects directly to the ratchet and pinlock suspension systems of the 3M™ H-700 and 3M™ H-800 Series of hard hats

Lightweight design offers enhanced comfort with less bulk on the job

Anti-fog lens helps workers see clearly

Easy to maneuver and adjust for closeness and height

Available in amber, gray, and clear lenses

Suggested for use in multiple industries including automotive, transportation, construction, manufacturing, mining, facility sanitation, heavy infrastructure, oil and gas, pharmaceutical, and more

Meets the impact requirements of ANSI Z87.1

Typical properties

Case Quantity

20

Compatible Hard Hat

H-700, H-700T, H-800, X5000

Features

Accommodates 3M Helmet Mounted Earmuffs

For Use With

Hard Hats

Material

Polycarbonate

Product Color

Amber, Gray, Transparent

Product Series

V9

Product Type

Hard Hat A

3M™ Versaflo™ Over-visor Frame M-961N, 1 EA/Case

3M Product Number M-961N 3M ID 7100154127 UPC 00076308942748

Details

Designed for 3M™ Versaflo™ M-307 and M-407 helmets
Modular
Low profile
Over-visor

Typical properties

Brands
Versaflo™
Compatible Respirator Type
SAR
Compatible With
3M™ Versaflo™ M-Series Helmet
Coupling Size
0.25" MPT, 3/8" Body Size, Industrial Interchange
Headgear Type
Headcover
High Heat
Yes
Material
Aluminized Fabric
Product Series
Ve

3M™ Squeeze Clamp W-3222-2/07036(AAD) 2 Clamps/Bag

3M Product Number W-3222-2 3M ID 7000056528 UPC 50051131070368

Details

For use with 3M™ Hoods H-Series

Typical properties

Brands

3M™

CFM Capacity per Minute

50 CFM

Compatible With

3M™ H-Series Headgear

Headgear Type

Hood

High Heat

No

Product Color

White

Product Series

H-Series

Product Type

Hardware

Recommended Industry

Marine

Supplied Air Respirator Style

3M™ PELTOR™ Optime™ 101 Earmuffs H7B, Behind-the-Head, 10 EA/Case

3M Product Number H7B 3M ID 7000002329 UPC 10093045080721

Details

For noise levels up to 101 dBA

Stainless steel band distributes weight for low-pressure fit

Noise Reduction Rating (NRR Class A.)*: 26 dB. CS

*The NRR may overestimate the hearing protection provided during typical use

Typical properties

Attenuation Rating

27.0 Decibel

Bluetooth

No

Brands

PELTOR™

Case Quantity

10

Corded

No

Dielectric

No

Earmuff Style

Behind the Head

Electrically Insulated

No

Hearing Protection Style

Behind-the-Head

Hearing Protection Type

Headband

Mate

3M™ No-Touch™ Earplugs

Details

Paddle grips help with earplug insertion or removal

Inserting the ear tips with the paddle grips helps the ear tips stay clean, even when hands or gloves are dirty

Bell shaped foam ear tips are designed to fit a wide range of ear canal sizes and shapes

Compatible with the 3M™ E-A-Rfit™ Validation System

Noise reduction rating (NRR)*: 29 dB

Available with or without cords to suit user preference

*U.S. EPA specifies the NRR as the measure of hearing protector noise reduction. However, 3M makes no warranties as to the suitability of the NRR for this purpose. 3M strongly recommends personal fit testing of hearing protectors. Research suggests that users may receive less noise reduction than indicated by the attenuation label value(s) on the packaging due to variation in fit, fitting skill, and motivation of the user. Refer to applicable regulations or guidance on how to adjust attenuation label values. It is recommended that the NRR be reduced by 50% to better estimate typical protection

Typical properties

Attenuation Rating

29.0 Decibel

Banded

No

Brands

3M™

Case Quantity

400 Pair

Cord Color

Yellow

Cord Material

Vinyl

Cord Type

None, Vinyl

Corded

No, Yes

Dielectric

No

Dispenser Available

No

Earplug Color

Purple

Earplug Material

Foam/T

3M™ Infant Eartip 4.0mm 420-2095, 10 Pair EA/Case

3M Product Number 420-2095 3M ID 7100133268 UPC 10080529510119

Details

3M PSD products are for occupational use only

*The NRR may overestimate the hearing protection provided during typical use

Typical properties

Brands

3M™

Case Quantity

10

Hearing Protection Style

Probed for Fit Testing

Product Type

Infant Eartip

Shape

Cylinder

3M™ E-A-Rfit™ Dual-Ear Enclosure Assembly Speaker 073-783

3M Product Number 073-783 3M ID 7100077866 UPC 00078371670139

Details

Enclosure Assembly Speaker for use with 3M™ E-A-Rfit™ Dual-Ear Validation System

Connects to an AC power source

Presents a test signal across seven test frequencies (125Hz, 250Hz, 500Hz, 1000Hz, 2000Hz, 4000Hz, 8000Hz) in under five seconds

USB Cable connects speaker to computer (not included)

Dual-element microphone plugs into back of speaker (not included)

Stand and cables not included

Designed as a replacement speaker within your current 3M E-A-Rfit Dual-Ear Validation System kit

Typical properties

Brands

E-A-R™

Case Quantity

1

Product Color

Black

Product Type

Speaker

Recommended Application

Health & Safety Testing

Recommended Industry

Automotive, General Manufacturing, Metal Fabrication, Military Maintenance, Repair & Operation (MRO), Mi

3M™ Aura Healthcare Particulate Respirator 1800+ Series

Details

Unique three-panel design fits a wide range of face shapes/sizes* and accommodates facial movements while talking
Sculpted top panel helps conform to nose and eye contours, allowing more room for eyewear
Embossed top panel directs exhaled air away from the nose panel, helping reduce eyewear fogging
Individual packaging helps protect the respirator from contamination
Flat fold design offers convenient storage and portability
Innovative chin tab designed for ease of positioning, donning & adjustment
Soft nose foam and smooth inner materials feel comfortable against skin
Adjustable noseclip helps provide a custom and secure seal
3M proprietary filter media designed for easy breathing
FDA cleared for use as a surgical mask
NIOSH approved for at least 95 percent filtration efficiency against certain non-oil based particulates
Collapse resistant and compatible with a variety of eyewear
Patented. See 3M.com/patent

Typical properties

Advanced Electrostatic Media
Yes
BFE
> 99%
Braided Comfort Strap
No
Class
Premium
Exhalation Valve
No
Faceseal
No
Features
Advanced Electrostatic Media, Individually Wrapped, Nosefoam, Stapled
Headband
Filter Class
N95
Flame Resistance (AS)

3M™ Adflo™ Rubber Breathing Tube Rubber O-Ring 15-0099-12, 2 ea/Bag

3M Product Number 15-0099-12 3M ID 7000126796 UPC 00051131932517

Details

O-ring
Replacement Part

Typical properties

Brands

Adflo™

Case Quantity

1

Features

Respiratory Accessory

Product Series

Adflo

Recommended Application

Assembly, Facility Maintenance, Grinding, Machine Operation, Sanding, Welding

Recommended Industry

Design & Construction, Heavy Infrastruc

3M™ PAPR Battery Chargers & Charging Components

Details

Ease to use
Replacement Part

Typical properties

Brands

3M™

Case Quantity

1

Compatible With

3M™ Airstream™ PAPR, 3M™ Versaflo™ TR-300 Series Battery, 3M™ Versaflo™ TR-600 Series Battery, 3M™ Versaflo™ TR-800 Series Battery

Hazard Type

Silica

Intrinsically Safe

No

Number of Stations

1 , 4

Pr

3M™ Versaflo™ Storage Plugs BT-957 5/CS

3M Product Number BT-957 3M ID 7100176778 UPC 00051131278400

Details

There are 5 storage caps in every case
Use to aid safe storage of equipment
Designed for use with 3M™ Powered Air Respirators

Typical properties

Brands
Versaflo™
Cartridge or Filter Included
No
Clip-on Welding Shield
No
Compatible Respirator Type
PAPR
Compatible With
3M™ Versaflo™ BT-Series Breathing Tube
Enhanced Comfort
No
Enhanced Durability
No
Eye Protection
No
Intrinsically Sa

3M™ Versaflo™ Plug W-3251-2, 1/2 in Body Size, 1/4 in MPT, Schrader 2 EA/Case

3M Product Number W-3251-2 3M ID 7010346759 UPC 00051138213275

Details

Used on the 3M™ Connector W-3195
Use to aid safe storage of equipment
Designed for use with 3M™ Powered Air Respirators

Typical properties

Brands
Versaflo™
CFM Capacity per Minute
100 CFM, 50 CFM
Pressure Type
Low
Product Color
Metal
Product Series
Whitecap
Product Type
Plug
Supplied Air Respirator Style
MST Portable and Fixed Panels, Versaflo™ AP-600 Portable Panels, W-Series S

**3M™ Plug W-3198-2/07156(AAD), 1/2 in Body Size, 3/8 in FPT,
Schrader
2/Case**

3M Product Number W-3198-2 3M ID 7100017458 UPC 50051131071563

Details

For use with 3M™ Whitecap Helmets
Use to aid safe storage of equipment
Designed for use with 3M™ Powered Air Respirators

Typical properties

Brands
3M™
CFM Capacity per Minute
100 CFM, 50 CFM
Product Color
Metal
Product Series
Whitecap
Product Type
Plug
Recommended Industry
Marine
Supplied Air Respirator Style
MST Portable and Fixed Panels, Versaflo™ AP-600 Portable Panels, W-Seri

3M™ Plug W-3279-2, 1/4 in Body Size, 1/4 in FPT, Industrial Interchange

2/Case

3M Product Number W-3279-2 3M ID 7000051868 UPC 00051138289874

Details

For use with 3M™ Whitecap Helmets
Use to aid safe storage of equipment
Designed for use with 3M™ Powered Air Respirators

Typical properties

Brands
3M™
CFM Capacity per Minute
100 CFM, 50 CFM
Case Quantity
2/bag
Pressure Type
High
Product Color
Metal
Product Series
Whitecap
Product Type
Plug
Supplied Air Respirator Style
MST Portable and Fixed Panels, Versaflo™ AP-600 Portable P

Dimensions and Classifications

Overall Length (Imperial)
1 in
Overall Length (Metric)
0.64 cm

3M™ Plug W-3080-2, 1/4 in Body Size, 1/4 in FPT, Industrial Interchange

2/Case

3M Product Number W-3080-2 3M ID 7000005399 UPC 50051138214673

Details

For use with 3M™ Whitecap Helmets
Use to aid safe storage of equipment
Designed for use with 3M™ Powered Air Respirators

Typical properties

Brands
3M™
Case Quantity
2/pack
Compatible With
3M™ Supplied Air Systems
Pressure Type
High
Product Color
Metal
Product Series
Whitecap
Product Type
Plug
Supplied Air Respirator Style
MST Portable and Fixed Panels, Versaflo™ AP-600 Portable

Dimensions and Classifications

Overall Length (Imperial)
1 in
Overall Length (Metric)
0.64 cm

3M™ Versaflo™ Plug W-3252-2, 3/8 in Body Size, 1/4 in MPT, Industrial Interchange, 2 ea/Case

3M Product Number W-3252-2 3M ID 7000130793 UPC 00051138214937

Details

Used with the 3M™ Connector W-3195
Use to aid safe storage of equipment
Designed for use with 3M™ Powered Air Respirators

Typical properties

Brands
Versaflo™
CFM Capacity per Minute
100 CFM, 50 CFM
Case Quantity
2/pack
Fitting Type
Industrial Interchange
Pressure Type
Low
Product Color
Metal
Product Series
Whitecap
Product Type
Plug
Supplied Air Respirator Style
MST Portable a

Dimensions and Classifications

Overall Length (Imperial)
3 in
Overall Length (Metric)
0.95 cm

3M™ Versaflo™ Plug W-1279-2, 1/4 in Body Size, 1/4 in MPT, Industrial Interchange 2 EA/Case

3M Product Number W-1279-2 3M ID 7000005400 UPC 00051138164294

Details

Industrial interchange standard fitting used for air control valves
1/4 inch MPT high pressure plug made of steel
Designed for use with 3M™ Powered Air Respirators

Typical properties

Brands
Versaflo™
Case Quantity
2/pack
Compatible With
Air Control Valve
Product Color
Metal
Product Series
Whitecap
Product Type
Plug
Supplied Air Respirator Style
MST Portable and Fixed Panels, Versaflo™ AP-600 Portable Panels, W-Series
Fixe

Dimensions and Classifications

Overall Length (Imperial)
1 in
Overall Length (Metric)
0.64 cm

3M™ Schrader Plug W-3183-2, 1/4 in Body Size, 1/4 in FPT, Schrader 2 Plugs/Pkg

3M Product Number W-3183-2 3M ID 7000130789 UPC 00051138214791

Details

For use with 3M™ Whitecap Helmets
Use to aid safe storage of equipment
Designed for use with 3M™ Powered Air Respirators

Typical properties

Brands
3M™
Case Quantity
2/pack
Product Color
Metal
Product Series
Whitecap
Product Type
Plug
Supplied Air Respirator Style
MST Portable and Fixed Panels, Versaflo™ AP-600 Portable Panels, W-Series
Fixed Panels

Dimensions and Classifications

Overall Length (Imperial)
1 in
Overall Length (Metric)
0.64 cm

3M™ Plug W-3057-2/07155(AAD), 3/8 in Body Size, 3/8 in FPT, Industrial Interchange 2/Case

3M Product Number W-3057-2 3M ID 7000130989 UPC 50051131071556

Details

For use with 3M™ Whitecap Helmets
Use to aid safe storage of equipment
Designed for use with 3M™ Powered Air Respirators

Typical properties

Brands
3M™
Case Quantity
2/bag
Product Color
Metal
Product Series
Whitecap
Product Type
Plug
Recommended Industry
Marine
Supplied Air Respirator Style
MST Portable and Fixed Panels, Versaflo™ AP-600 Portable Panels, W-Series
Fixed Panels

Dimensions and Classifications

Overall Length (Imperial)
3 in
Overall Length (Metric)
0.95 cm

3M™ Versaflo™ Plug W-3186-2, 1/4 in Body Size, 1/4 in MPT Schrader, 2 ea/Case

3M Product Number W-3186-2 3M ID 7000130791 UPC 50051138214826

Details

1/4 inch MPT steel fitting
Use to aid safe storage of equipment
Designed for use with 3M™ Powered Air Respirators

Typical properties

Brands
Versaflo™
Case Quantity
2/bag
Product Color
Metal
Product Series
Whitecap
Product Type
Plug
Supplied Air Respirator Style
MST Portable and Fixed Panels, Versaflo™ AP-600 Portable Panels, W-Series
Fixed Panels

Dimensions and Classifications

Overall Length (Imperial)
1 in
Overall Length (Metric)
0.64 cm

3M™ Half Facepiece Disposable Respirator Assembly 5103, Organic Vapor/Acid Gas, Small 12 EA/Case

Part Number 66070 3M Product Number 5103 3M ID 7000126025

Details

NIOSH-approved against certain organic vapors (black label)
Recommended for use in a variety of workplace applications, including petrochemical, chemical manufacturing, construction, transportation, electronics, and more

This respiratory protection system is not for use in environments that are immediately dangerous to life or health (IDLH)

This respirator can be worn with additional personal protective equipment (PPE)
For workplace/occupational use only

Typical properties

Accessories

No

Adjustable Buckle Straps

Yes

Assigned Protection Factor

10

Brands

3M™

Cartridge or Filter Included

Yes

Case Quantity

12/case

Clip-on Welding Shield

No

Compatible with 3M™ PAPR Systems

No

Compatible with 3M™ Supplied Air Syst

3M™ Half Facepiece Disposable Respirator Assembly 5101, Organic Vapor, Small 12 EA/Case

Part Number 66070 3M Product Number 5101 3M ID 7000126024

Details

NIOSH-approved against certain organic vapors (black label)
Recommended for use in a variety of workplace applications, including petrochemical, chemical manufacturing, construction, transportation, electronics, and more
This respiratory protection system is not for use in environments that are immediately dangerous to life or health (IDLH)
This respirator can be worn with additional personal protective equipment (PPE)
For workplace/occupational use only

Typical properties

Accessories
No
Assigned Protection Factor
10
Brands
3M™
Case Quantity
12
Clip-on Welding Shield
No
Compatible with 3M™ PAPR Systems
No
Compatible with 3M™ Supplied Air System
No
Compatible with Welding Shield
No
Connection Type
Permanent

3M™ Half Facepiece Disposable Respirator Assembly 53P71, Organic Vapor/P95 Respiratory Protection, Large 12 EA/Case

Part Number 07193 3M Product Number 53P71 3M ID 7000052081

Details

NIOSH-approved against certain organic vapors (black label)
Recommended for use in a variety of workplace applications, including petrochemical, chemical manufacturing, construction, transportation, electronics, and more

This respiratory protection system is not for use in environments that are immediately dangerous to life or health (IDLH)

This respirator can be worn with additional personal protective equipment (PPE)
For workplace/occupational use only

Typical properties

Accessories

No

Adjustable Buckle Straps

Yes

Assigned Protection Factor

10

Brands

3M™

Cartridge or Filter Included

Yes

Case Quantity

12/case

Clip-on Welding Shield

No

Compatible with 3M™ PAPR Systems

No

Compatible with 3M™ Supplied Air Syst

3M™ Half Facepiece Disposable Respirator Assembly 5203, Organic Vapor/Acid Gas, Medium 12 EA/Case

Part Number 21573 3M Product Number 5203 3M ID 7000051847

Details

NIOSH-approved against certain organic vapors (black label)
Recommended for use in a variety of workplace applications, including petrochemical, chemical manufacturing, construction, transportation, electronics, and more

This respiratory protection system is not for use in environments that are immediately dangerous to life or health (IDLH)

This respirator can be worn with additional personal protective equipment (PPE)
For workplace/occupational use only

Typical properties

Accessories

No

Adjustable Buckle Straps

Yes

Assigned Protection Factor

10

Brands

3M™

Cartridge or Filter Included

Yes

Case Quantity

12/case

Clip-on Welding Shield

No

Compatible with 3M™ PAPR Systems

No

Compatible with 3M™ Supplied Air Syst

3M™ Half Facepiece Disposable Respirator Assembly 5303, Organic Vapor/Acid Gas, Large 12 EA/Case

Part Number 21579 3M Product Number 5303 3M ID 7000051848

Details

NIOSH-approved against certain organic vapors (black label)
Recommended for use in a variety of workplace applications, including petrochemical, chemical manufacturing, construction, transportation, electronics, and more

This respiratory protection system is not for use in environments that are immediately dangerous to life or health (IDLH)

This respirator can be worn with additional personal protective equipment (PPE)
For workplace/occupational use only

Typical properties

Accessories

No

Adjustable Buckle Straps

Yes

Assigned Protection Factor

10

Brands

3M™

Cartridge or Filter Included

Yes

Case Quantity

12/case

Clip-on Welding Shield

No

Compatible with 3M™ PAPR Systems

No

Compatible with 3M™ Supplied Air Syst

3M™ Half Facepiece Disposable Respirator Assembly 5301, Organic Vapor, Large 12 EA/Case

Part Number 66070 3M Product Number 5301 3M ID 7000126027

Details

NIOSH-approved against certain organic vapors (black label)
Recommended for use in a variety of workplace applications, including petrochemical, chemical manufacturing, construction, transportation, electronics, and more

This respiratory protection system is not for use in environments that are immediately dangerous to life or health (IDLH)

This respirator can be worn with additional personal protective equipment (PPE)
For workplace/occupational use only

Typical properties

Accessories

No

Assigned Protection Factor

10

Brands

3M™

Case Quantity

12

Clip-on Welding Shield

No

Compatible with 3M™ PAPR Systems

No

Compatible with 3M™ Supplied Air System

No

Compatible with Welding Shield

No

Connection Type

Permanent

3M™ Half Facepiece Disposable Respirator Assembly 5201, Organic Vapor, Medium 12 EA/Case

Part Number 66070 3M Product Number 5201 3M ID 7000126026

Details

NIOSH-approved against certain organic vapors (black label)
Recommended for use in a variety of workplace applications, including petrochemical, chemical manufacturing, construction, transportation, electronics, and more

This respiratory protection system is not for use in environments that are immediately dangerous to life or health (IDLH)

This respirator can be worn with additional personal protective equipment (PPE)
For workplace/occupational use only

Typical properties

Accessories

No

Assigned Protection Factor

10

Brands

3M™

Case Quantity

12

Clip-on Welding Shield

No

Compatible with 3M™ PAPR Systems

No

Compatible with 3M™ Supplied Air System

No

Compatible with Welding Shield

No

Connection Type

Permanent

3M™ Half Facepiece Disposable Respirator Assembly 51P71, Organic Vapor, P95, Small 12 EA/Case

Part Number 66070 3M Product Number 51P71 3M ID 7000052079

Details

NIOSH-approved against certain organic vapors (black label)
Recommended for use in a variety of workplace applications, including petrochemical, chemical manufacturing, construction, transportation, electronics, and more

This respiratory protection system is not for use in environments that are immediately dangerous to life or health (IDLH)

This respirator can be worn with additional personal protective equipment (PPE)
For workplace/occupational use only

Typical properties

Accessories

No

Adjustable Buckle Straps

Yes

Assigned Protection Factor

10

Brands

3M™

Cartridge or Filter Included

Yes

Case Quantity

12/case

Clip-on Welding Shield

No

Compatible with 3M™ PAPR Systems

No

Compatible with 3M™ Supplied Air Syst

3M™ Full Face Plug 7890, Replacement Part 20 EA/Case

3M Product Number 7890 3M ID 7000029584 UPC 50021200603315

Details

Approved 3M replacement part
Designed for use 3M Full Facepiece 6000DIN and 7800S (sold separately)
Plug seals DIN port
Replacement part can extend service life of facepiece
Replaceable part can potentially result in respiratory equipment cost savings

Typical properties

Accessories
No
Brands
3M™
Case Quantity
4/pack
Clip-on Welding Shield
No
Compatible with 3M™ PAPR Systems
No
Compatible with 3M™ Supplied Air System
No
Compatible with Welding Shield
No
Cool Flow™ Exhalation Valve
No
Drop-down Feature
No

3M™ DIN Port Adapter Assembly 6884, 5 EA/Case

3M Product Number 6884 3M ID 7000002032 UPC 50051138541496

Details

Approved 3M system component
Replacement part for 3M Full Facepieces 6000DIN (sold separately)
Use to convert a 3M Full Facepiece 6000 (sold separately) to a full facepiece 6000DIN
Adapter can extend service life of facepiece
Replaceable part can potentially result in respiratory equipment cost savings

Typical properties

Brands
3M™
Case Quantity
1/pack
Compatible Respirator
6000 Series
Headgear Type
Full Facepiece
Product Color
Black
Product Series
Powerflow
Product Type
Replacement Parts & Accessories
Purpose
Parts, Parts and Accessories
eClass 14 Classif

3M™ Rugged Comfort Quick Latch Half Facepiece Reusable Respirator 6503QL/49492, Large, 10 EA/Case

Part Number 49492 3M Product Number 6503QL 3M ID 7000128241

Details

Recommended industries include construction, general manufacturing, heavy infrastructure, industrial maintenance, mining, oil and gas, transportation, and more

Use with 3M™ Particle Filters 2000, 2200, 7000, or 5000 Series to filter certain particulates

Use with 3M 6000 Series Gas/Vapor Cartridges to help filter a broad range of gases and vapors

Use with 3M 6000 Series Combination Cartridges to help filter particulates in addition to gases and vapors

Compatible with 3M™ TR-600 and TR-800 powered air purifying respirators against a variety of gases, vapors, and particulate hazards

Silicone face seal keeps its shape even in hot work conditions

Low-profile half facepiece design is compatible with many welding and grinding shields

For workplace/occupational use only

Typical properties

Accessories

No

Assigned Protection Factor

10

Brands

3M™

Case Quantity

10/case

Clip-on Welding Shield

No

Compatible With

Line Compressed Air System SA Series

Compatible with 3M™ PAPR Systems

No

Compatible with 3M™ Supplied Air System

No

Com

3M™ Speedglas™ Heavy-Duty Back Pack BPK-HD, 3 ea/Case

3M Product Number BPK-HD 3M ID 7100282441 UPC 04064035055950

Details

Back Pack Harness optimized for welding environment
Back Pack designed for holding 3M™ Adflo™ and 3M™ Versaflo™ PAPR's
Designed for comfort
Fits a wide variety of body sizes
Made for heavy duty industries
Flame retardant harness designed for Welding environment withstanding spatter and sparks
Ventilated design against back
Shoulder Harnesses adjustable position, length, width and a chest strap for extra tight fit well balanced on the back
Designed to be perceived as balanced when carried
Carry / Hang Handle when stored in a dry and clean area
Attachment Plate Dimensions: 390mm x 220mm

Typical properties

Brands
Speedglas™
Case Quantity
3
Compatible Respirator
3M Adflo Powered Air Purifying Respirator, TR-300 Series, TR-300N+ Series, TR-600 Series, TR-800 Series
Compatible Welding Helmet
Adflo
Compatible with 3M™ PAPR Systems
Yes
Compatible with

3M™ Speedglas™ Protective Bag 06-0500-65, 1 EA/Case

3M Product Number 06-0500-65 3M ID 7000128219 UPC 00051131494787

Details

Protective Bag

Replacement Part

Comfortably carry your powered air respiratory protection (PAPR) system with welding system backpacks

For highest possible safety and comfort, regularly check your equipment for worn or damaged parts

Carry or store your equipment for best comfort or care

Typical properties

Brands

Speedglas™

Case Quantity

1

Compatible Welding Helmet

9100 MP Welding Helmets

Features

9100 Series Accessory

For Use With

3M™ Speedglas™ 9100MP Welding Helmets

Product Color

Black

Product Series

9100, 9100 FX, 9100 FX-Air, 9100 MP, 9100

3M™ Speedglas™ G5 Task Light Pouch for 3M™ Adflo™ Battery, 35-1099-00

3M Product Number 35-1099-00 3M ID 7100216922 UPC 00076308944926

Details

Made in flame-retardant fabric for protection against sparks and spatter

Worn on belt

For maximum safety and comfort, make it a habit to check your equipment regularly

Replace worn out or damaged parts

Carry or store your equipment for best comfort or care

Typical properties

Brands

Speedglas™

Compatible Welding Helmet

G5-01 Welding Helmets

Product Color

Black

Product Series

G5

Product Type

Pouch

Recommended Application

Grinding, Metal Processing, Metal Repair, Welding

Recommended Industry

General Manufacturing, H

3M™ Speedglas™ SideWindows Coverplate 9100 06-0500-53, 2 EA/Case

3M Product Number 06-0500-53 3M ID 7000127140 UPC 50051135893772

Details

SideWindow Cover Plate
Replacement Part

Typical properties

Brands
Speedglas™
Case Quantity
2
Compatible Welding Helmet
9100 Series
Features
9100 Series Accessory
For Use With
3M™ Speedglas™ 9100 Air Welding Helmets
Product Color
Black
Product Series
9100, 9100 QR, 9100-Air
Recommended Application
A

3M™ Speedglas™ G5-03 Pro/Air Side Windows Coverplate 10-0500-53

3M Product Number 10-0500-53 3M ID 7100312605 UPC 00638060430651

Details

Blocking side light

Typical properties

Brands
Speedglas™
Compatible Welding Helmet
G5-03 Series
Part Type
Spare Part
Product Series
G5
Product Type
Side Window Cover
eClass 14 Classification Group
40300190

3M™ Scotchlite™ Reflective Material 8935 Series

Details

3M™ Scotchlite™ Reflective Material is designed for enhancing visibility in low light and nighttime conditions
Certified to various global high visibility standards such as ANSI/ISEA 107
Certified to various flame resistant standards such as NFPA
Suitable for applications that will be exposed to industrial laundering
Sew-on application

Typical properties

Adhesive
None
Attachment Type
Sew On
Backing
None
Backing Material
Flame Retardant Cotton
Brands
Scotchlite™
Certified Performance Required
ANSI 107-2015, CGSB, CSA Z95-2015, NFPA
Daytime Color
Silver
Dry-Cleaning Cycles at ANSI Certified St

Dimensions and Classifications

Overall Length (Imperial)
54.68 yd, 109.36 yd, 218.72 yd
Overall Length (Metric)
50 m, 100 m, 200 m
Overall Width (Imperial)
0.5 in, 1 in, 1.02 in, 1.5 in, 1.63 in, 2 in, 3 in, 3.5 in, 6.25 in, 8.5 in, 36 in, 50 in
Overall Width (Metric)
12.7 mm, 1

3M™ Scotchlite™ Reflective Material 9587 Series

Details

Compliant brightness designed for enhancing visibility of wearer in low light and nighttime conditions
Certified to major flame-resistance standards
Fluorescent properties help ensure high visibility in daylight, dawn, and dusk
Sew-on application
Printed with 3M trademarks for easy identification

Typical properties

Adhesive
None
Attachment Type
Sew On
Backing
None
Backing Material
Aramid
Brands
Scotchlite™
Certified Performance Required
ANSI 107-2015, CGSB, NFPA
Daytime Color
Yellow/Silver
Dry-Cleaning Cycles at ANSI Certified Standards
30
Flame Resi

Dimensions and Classifications

Overall Length (Imperial)
109.36 yd
Overall Length (Metric)
100 m
Overall Width (Imperial)
2 in, 3 in
Overall Width (Metric)
50.8 mm, 76.2 mm

3M™ Speedglas™ Welding Helmet 100 QR, 07-0112-00BL-QR, Without Rail, Hardhat, ADF, 1 EA/CASE

3M Product Number 07-0112-00BL-QR 3M ID 7100200571 UPC 00076308943783

Details

Welding helmet with quick-release rail attachment for hard hat allows for transition between welding and non-welding jobs

ADF with five adjustable dark shades 8–12

Three sensitivity settings for customized light-to-dark switching

Applications include assembly, assembly and mechanical, facility maintenance, grinding, machine operations, metal repair, sanding, and welding

Assembly is compliant with ANSI Z87-2003, and in hard hat assemblies, ANSI Z89-20

Typical properties

Brands

Speedglas™

Case Quantity

1

Lens Type

No Lens

Product Color

Black

Product Series

100

Recommended Application

Assembly, Facility Maintenance, Grinding, Machine Operation, Sanding, Welding

Recommended Industry

Construction, Heavy Infrastr

3M™ Centurion™ 452 Series Safety Impact Goggles

Details

Models with indirect ventilation provide splash protection
Over-the-glass coverage accommodates most prescription eyewear
Direct ventilation system helps reduce the build-up of fog
Polycarbonate lens absorbs 99.9% of UV rays
Adjustable elastic strap
Meets the Impact-Rated Protector requirement of the ANSI-ISEA Z87.1-2020 Standard

Typical properties

ANSI Requirements

ANSI Z87.1-2003

Anti Fog Lens

No, Yes

Case Quantity

10

Class

Value

Comfort Features

Direct Ventilation, Elastic Strap, Fits over most personal prescription eyewear

Eyewear Range

Value

Frame Material

Plastic

Frame Style

Gog

Dimensions and Classifications

Overall Height (Imperial)

3.2 in

Overall Height (Metric)

8.13 cm

Overall Length (Imperial)

7 in

Overall Length (Metric)

17.78 cm

Overall Width (Imperial)

3.4 in

Overall Width (Metric)

8.64 cm

3M™ DBI-SALA® Z Maxi Clamp Fastener Kit For Roof Top Anchor 7241204, Fits Bulb Standing Seam, 4 ea/Pack

Part Number 7241204 3M Product Number 7241204 3M ID 7100280773

Details

Durable materials and hardware designed to help stand up to harsh working conditions
Compatible with various fall arrest systems, not compliant for use with Horizontal Lifelines
Suitable for use in general industrial and construction industries
Compact, lightweight design
Meets the requirements for 29 CFR OSHA 1910.140 and 29 CFR OSHA 1926.502
Features corrosion-resistant, steel and aluminum construction for durability
This safety equipment is designed for use with additional personal protective equipment (PPE)
Z, U, and E Maxi Clamp 4-Pack Kits
For use with standing seam roof top anchor
Fits bulb, single folded, or double folded seams

Typical properties

Anchor Install Type
Reusable
Anchor Type
Roofing
Brands
DBI-SALA®
Case Quantity
1
Connected Safety ID Equipped
No
Dimensions
2.00x1.80x2.00in
For Use With
Standing Seam Roof Top Anchor
Install Type
Reusable
Material
Aluminum
Net Weight (

3M™ DBI-SALA® E Maxi Clamp 4-Pack for Standing Seam Roof Top Anchor 7241206, Silver, 1 Pack

Part Number 7241206 3M Product Number 7241206 3M ID 7100216316

Details

Durable materials and hardware designed to help stand up to harsh working conditions
Compatible with various fall arrest systems, not compliant for use with Horizontal Lifelines
Suitable for use in general industrial and construction industries
Compact, lightweight design
Meets the requirements for 29 CFR OSHA 1910.140 and 29 CFR OSHA 1926.502
Features corrosion-resistant, steel and aluminum construction for durability
This safety equipment is designed for use with additional personal protective equipment (PPE)
Z, U, and E Maxi Clamp 4-Pack Kits
For use with standing seam roof top anchor
Fits bulb, single folded, or double folded seams

Typical properties

Anchor Install Type
Permanent
Anchor Type
Roofing
Brands
DBI-SALA®
Case Quantity
1,1 EA/Case
Connected Safety ID Equipped
No
Dimensions
(2.00x1.00x2.00)in
For Use With
Standing Seam Roof Top Anchor
Install Type
Reusable
Material
Aluminum

3M™ DBI-SALA® Rollgliss™ Descender, Sloped/Auto Retract

Details

Emergency rescue and evacuation from a wide variety of elevated work areas
Fully automatic controlled descent for sloped applications
Automatic retraction allows multiple evacuations
Corrosion resistant construction for maximum durability
Use repeatedly without factory service
Equipped with 3M™ Connected Safety ID (CSID)
Other lengths and models for vertical applications available

Typical properties

Case Quantity
1
CoWorker Controlled Ascent
No
CoWorker Controlled Descent
No
Connected Safety ID Equipped
Yes
Descent Type
Sloped
Lifeline Material
Galvanized Wire Rope, Stainless Steel Wire Rope
Line Length (Imperial)
115 ft, 200 ft
Line Le

Dimensions and Classifications

Overall Length (Imperial)
115 ft, 200 ft
Overall Length (Metric)
35.052 m, 61 m

3M™ Scotchlite™ Reflective Material 8986NFPA Series

Details

3M™ Scotchlite™ Reflective Material is designed for enhancing visibility in low light and nighttime conditions
Certified to various flame resistant standards such as NFPA
Fluorescent properties help to make material highly visible in daylight, dawn and dusk
Sew-on application

Typical properties

Adhesive
None
Backing
None
Backing Material
Flame Retardant Cotton
Brands
Scotchlite™
Certified Performance Required
NFPA
Daytime Color
Fluorescent Red-Orange
Flame Resistant
Yes
Home Wash Cycles 60°C (140°F) at ANSI Certified Standards
See

Dimensions and Classifications

Overall Length (Imperial)
54.68 yd, 109.36 yd
Overall Length (Metric)
50 m, 100 m
Overall Width (Imperial)
1 in, 2 in, 3 in, 36 in, 36.25 in
Overall Width (Metric)
25.4 mm, 50.8 mm, 76.2 mm, 914.4 mm, 920.75 mm

3M™ PELTOR™ ARC, Left & Right Side Attachments, 1 EA/Case

3M Product Number ARC 3M ID 7000128144 UPC 00093045935338

Details

Left and right guide arm attachments for mounting the headset onto a helmet rail system
Accessory Rail Connector (ARC)

Typical properties

Brands
PELTOR™
Intrinsically Safe
No
Product Color
Black
Product Type
Side Attachment
Purpose
Exclude
Recommended Industry
Military Tactical
eClass 14 Classification Group
40270191

3M™ Disposable Protective Coverall 4530

Details

Secondary flame spread-resistant treatment
Constructed from SMMS material for Type 5 and Type 6 protection
Anti-static treatment can help reduce static build-up
Two-way zipper with sealable storm flap helps provide additional protection against contaminants
Knit cuffs provide a soft wrist closure for increased comfort
Recommended for use in multiple industries including mining, oil and gas, and more
25 units included in each case

Typical properties

Closure Method
Two-way Zipper
Coverall Style
Collared, Hooded
Features
3 Panel Hood, Anti-static, Collar (No Hood), Elastic Waist & Ankle, Flame Resistance, Knitted Cuff, Radioactive Particulate Protection
Hazard Type
Dust, Light Liquid splash, Par

3M™ PELTOR™ Audio Input Cable FL6M, 2.5mm Mono Plug, 1 ea/cs

3M Product Number FL6M 3M ID 7000107806 UPC 07318640010956

Details

A patch cable that connects certain PELTOR headsets to microphones, radios or other personal entertainment devices (listen only)

For use with PELTOR headsets that have an available J22 auxiliary port

Convenient 2.5mm mono plug is compatible with many common devices

36-inch straight cable

Meets UL specifications

Typical properties

Auxiliary Port

J22

Brands

PELTOR™

Compatible Radio Brands

2.5mm auxiliary port

Intrinsically Safe

No

Plug Type

2.5 mm Mono

Product Color

Black

Product Type

Cable

Purpose

Exclude

Recommended Application

Facility Maintenance

eClass 14 Clas

**3M™ PELTOR™ Communication Cable Kit 88055-00000, for FM53,
M50, C50
Protective Masks, 1 EA/Case**

3M Product Number 88055-00000 3M ID 7010342068 UPC 00093045935260

Details

Cable Kit for FM53, M50 & C50 protective Avon masks
1 EA/Case

Typical properties

Brands
PELTOR™
Product Type
Cable Kit
Purpose
Exclude
Recommended Industry
Military Tactical
eClass 14 Classification Group
40270191

3M™ PELTOR™ Extension Cables 88058-00000, 1 EA/Case

3M Product Number 88058-00000 3M ID 7010340656 UPC 10093045933072

Details

Extension Cables: 26" FL5601 02 Extension Cable for VIC III w/ AP107 Bailout
88058 00001
1 EA/Case

Typical properties

Brands
PELTOR™
Intrinsically Safe
No
Product Type
Cable
Purpose
Exclude
eClass 14 Classification Group
40270191

3M™ PELTOR™ Audio Input Cable FL6M-03, 2.5mm Mono Plug, 1 ea/cs

3M Product Number FL6M-03 3M ID 7000141074 UPC 07318640033726

Details

A patch cable that connects certain PELTOR headsets to microphones, radios or other personal entertainment devices (listen only)

For use with PELTOR headsets that have an available J22 auxiliary port

Convenient 2.5mm mono plug is compatible with many common devices

12-inch curly cable

Typical properties

Auxiliary Port

J22

Brands

PELTOR™

Compatible Radio Brands

2.5mm auxiliary port

Intrinsically Safe

No

Plug Type

2.5 mm Mono

Product Color

Black

Product Type

Cable

Purpose

Exclude

eClass 14 Classification Group

40270191

3M™ PELTOR™ Audio Input Cable FL6H-03, 3.5mm Mono Plug, 50 ea/Case

3M Product Number FL6H-03 3M ID 7000141073 UPC 07318640033719

Details

A patch cable that connects certain PELTOR headsets to microphones, radios or other personal entertainment devices (listen only)

For use with PELTOR headsets that have an available J22 auxiliary port

Convenient 3.5mm mono plug is compatible with many common devices

12-inch curly cable

Typical properties

Auxiliary Port

J22

Brands

PELTOR™

Compatible Radio Brands

3.5mm auxiliary port

Intrinsically Safe

No

Plug Type

3.5mm Mono

Product Color

Black

Product Type

Cable

Purpose

Exclude

Recommended Industry

Automotive, General Manufacturing, Metal

3M™ PELTOR™ Audio Input Cable FL6N, 3.5mm Stereo Plug 1 EA/Case

3M Product Number FL6N 3M ID 7100064600 UPC 07318640034051

Details

A patch cable that connects certain PELTOR headsets to microphones, radios or other personal entertainment devices (listen only)

For use with PELTOR headsets that have an available J22 auxiliary port

Convenient 3.5mm stereo plug is compatible with many common devices

36-inch straight cable

Meets UL specifications

Typical properties

Auxiliary Port

J22

Brands

PELTOR™

Compatible Radio Brands

3.5mm auxiliary port

Intrinsically Safe

No

Plug Type

3.5mm Stereo

Product Color

Black

Product Type

Cable

Purpose

Exclude

eClass 14 Classification Group

40270191

3M™ PELTOR™ Patch Cord FL6CT, 1 ea/cs

3M Product Number FL6CT 3M ID 7100064519 UPC 07318640042735

Details

Patch cable for use with the 3M™ PELTOR™ LiteCom Plus and LiteCom Pro II Headsets

3.5mm plug is compatible with most mobile phones and MP3 players

CAUTION: Not certified for Intrinsic Safety

Listen-only cable

Choose between stereo or mono output

Typical properties

Auxiliary Port

4-pin XLR

Brands

PELTOR™

Compatible Radio Brands

3.5mm auxiliary port

Intrinsically Safe

No

Plug Type

3.5mm Stereo

Product Color

Black

Product Type

Cable

Purpose

Exclude

Recommended Application

Facility Maintenance

eClass

3M™ PELTOR™ Audio Input Cable FL6H, 3.5mm Mono Plug 1 EA/Case

3M Product Number FL6H 3M ID 7000107805 UPC 07318640000629

Details

A patch cable that connects certain PELTOR headsets to microphones, radios or other personal entertainment devices (listen only)

For use with PELTOR headsets that have an available J22 auxiliary port

Convenient 3.5mm mono plug is compatible with many common devices

36-inch straight cable

Meets UL specifications

Typical properties

Auxiliary Port

J22

Brands

PELTOR™

Compatible Radio Brands

3.5mm auxiliary port

Intrinsically Safe

No

Plug Type

3.5mm Mono

Product Color

Black

Product Type

Cable

Purpose

Exclude

Recommended Industry

Automotive, General Manufacturing, Metal

3M™ PELTOR™ Microphone Post A44

3M Product Number A44 3M ID 7000107796 UPC 07318640066724

Details

Microphone post for mounting a boom microphone
Replacement part
Black

Typical properties

Brands
PELTOR™
Product Color
Black
Product Type
Microphone
eClass 14 Classification Group
40270191

3M™ DBI-SALA® Winch/SRL Mounting Bracket 8510224

Part Number 8510224 3M Product Number 8510224 3M ID 7100226853

Details

Winch/SRL mounting bracket with adaptor
Quick mount winch/SRL to tripod
Simple detent pin style attachment
Durable powder coated aluminum construction
Compact and lightweight design
Fits 8513158 tripod

Typical properties

Brands
DBI-SALA®
Case Quantity
1
Connected Safety ID Equipped
No
For Use With
3M™ DBI-SALA® Confined Space UCT-300 Aluminum Tripod 8513158
Net Weight (Imperial)
2.9 lb
Net Weight (Metric)
1.3 kg
Product Color
Silver
Recommended Industry
Con

3M™ Performance Respirator Paint Project 6111(Small)

3M ID 70006985629 UPC 00051138542504

Details

NIOSH-APPROVED 6001 OV CARTRIDGE HELPS REDUCE EXPOSURE to certain organic vapors encountered during activities involving latex and oil-based painting, including paint spraying*, varnishes, stains, sealants, solvents, certain solvent-based cleaners or pesticides**

NIOSH-APPROVED 5P71 P95 RATED FILTERS HELP REDUCE EXPOSURE to certain particles from paint spraying*, spray adhesives and pesticides**

FOR WORKPLACE/OCCUPATIONAL USE ONLY

LIGHTWEIGHT, FLEXIBLE, THERMOPLASTIC FACESEAL for comfort

3M™ BAYONET CONNECTION compatible with 3M™ cartridges and filters

CONVENIENT, REUSABLE DESIGN

OIL PROOF P-series particulate filter

6001 OV CARTRIDGE HELPS REDUCE EXPOSURE to certain organic vapors encountered during activities involving latex and oil-based painting, including paint spraying*, varnishes, stains, sealants, solvents, certain solvent-based cleaners or pesticides**

5P71 FILTER HELPS REDUCE EXPOSURE to certain particles from paint spraying*, spray adhesives and pesticides**

*Use a prefilter when spraying **Refer to Pesticide Product Label for Respirator Guidance or call 3M at 1-800-243-4630 or In Canada, call 1-800-267-4414

KIT CONTENTS: one facepiece, one pair of replaceable 6001 cartridges, one pair of 501 retainers and two pairs of replaceable 5P71 filters

Replacement cartridges (6001) and filters (5P71) available for economic repeat use of the facepiece

Size: Small

Also available in medium and large

Contains no components made from natural rubber

Typical properties

Application Type

Paint Project

Brands

3M™

Cartridge or Filter Included

Yes

Cartridge or Filter Type

Gas & Vapor

Catalog Number

6111P1-DC

Clip-on Welding Shield

No

Compatible with 3M™ PAPR Systems

No

Compatible with 3M™ Supplied Air System

Y

Dimensions and Classifications

Overall Height (Imperial)

8.9 in

Overall Height (Metric)

22.606 cm

Overall Length (Imperial)

5.1 in

Overall Length (Metric)

12.954 cm

Overall Width (Imperial)

9.3 in

Overall Width (Metric)

23.622 cm

3M™ DBI-SALA® Confined Space Portable Fall Arrest Post

Details

Provides one-three workers 360-degrees of movement and fall protection
Adjustable, vertical height from 32.75 in. (83.2 cm) to 57.25 in. (145.4 cm)
Can be used as an anchor point for horizontal lifeline systems
Integrated carrying handle
Durable, aluminum construction
Bases for 3M™ DBI-SALA® Portable Fall Arrest Posts are sold separately
Appropriate for Fall Protection in electrical transformer applications

Typical properties

Anchor Install Type
Reusable
Case Quantity
1
Connected Safety ID Equipped
No
Install Type
Portable
Material
Aluminum
Maximum Height (Imperial)
57.25 in
Maximum Height (Metric)
145.4 cm
Minimum Height (Imperial)
32.75 in
Minimum Height (Met

3M™ DBI-SALA® Concrete Bolt Fastener Kit For Roof Top Anchor 7241181, 300 mm, 4 ea/Pack

Part Number 7241181 3M Product Number 7241181 3M ID 7100241076

Details

Rugged and corrosion resistant material construction for durability with compact and lightweight design
Use vertically in wall or horizontally in ceiling (both components)
High strength steel construction
Compatible with various fall arrest systems
Meets the requirements for 29 CFR OSHA 1910.140, and OSHA 1926.502
Recommended for use in the construction, general industrial, mining, oil and gas, and utilities industries
This safety equipment is designed for use with additional personal fall protection systems (PPE)
Available in 6 in (15 cm) or 12 in (30.5 cm) 4-pack
Fastener kit for use with roof top anchor
Suitable for solid or hollow concrete structures

Typical properties

Anchor Install Type
Permanent
Anchor Type
Roofing
Brands
DBI-SALA®
Case Quantity
1
Connected Safety ID Equipped
No
For Use With
Roof Top Anchor
Install Type
Reusable
Material
Zinc Plated Steel
Net Weight (Imperial)
2.2 lb
Net Weight (Met

Dimensions and Classifications

Overall Length (Imperial)
12 in

3M™ DBI-SALA® Concrete Bolt Fastener Kit For Roof Top Anchor 7241180, 150 mm, 4 ea/Pack

Part Number 7241180 3M Product Number 7241180 3M ID 7100241075

Details

Rugged and corrosion resistant material construction for durability with compact and lightweight design
Use vertically in wall or horizontally in ceiling (both components)
High strength steel construction
Compatible with various fall arrest systems
Meets the requirements for 29 CFR OSHA 1910.140, and OSHA 1926.502
Recommended for use in the construction, general industrial, mining, oil and gas, and utilities industries
This safety equipment is designed for use with additional personal fall protection systems (PPE)
Available in 6 in (15 cm) or 12 in (30.5 cm) 4-pack
Fastener kit for use with roof top anchor
Suitable for solid or hollow concrete structures

Typical properties

Anchor Install Type
Permanent
Anchor Type
Roofing
Brands
DBI-SALA®
Case Quantity
1
Connected Safety ID Equipped
No
For Use With
Roof Top Anchor
Install Type
Reusable
Material
Zinc Plated Steel
Net Weight (Imperial)
1.8 lb
Net Weight (Met

Dimensions and Classifications

Overall Length (Imperial)
6 in

**3M™ Socket W-3199-2/07157(AAD), 1/2 in Body Size, 3/8 in FPT,
Schrader
2/Case**

3M Product Number W-3199-2 3M ID 7100017457 UPC 50051131071570

Details

For use with 3M™ Whitecap Helmets

Typical properties

Brands

3M™

Product Color

Brass

Product Series

Whitecap

Product Type

Socket

Recommended Industry

Marine

Supplied Air Respirator Style

MST Portable and Fixed Panels, Versaflo™ AP-600 Portable Panels, W-Series

Fixed Panels

3M™ Socket W-1449-2, 1/4 in Body Size, 3/8 in MPT, Industrial Interchange, 2/Case

3M Product Number W-1449-2 3M ID 7000005401 UPC 50051138165685

Details

A high pressure, 3/8 inch MPT twist lock fitting that is used on the 3M™ Compressed Air Filter and Regulator Panel W-2806

Typical properties

Brands
3M™
CFM Capacity per Minute
100 CFM, 50 CFM
Case Quantity
2/pack
Compatible With
3M™ W-2806 Filtration Panel
Pressure Type
High
Product Color
Brass
Product Series
Supplied Air
Product Type
Socket
Supplied Air Respirator Style
W-Ser

Dimensions and Classifications

Overall Length (Imperial)
1 in
Overall Length (Metric)
0.64 cm

3M™ Socket W-3281-2, 1/4 in Body Size, 3/8 in MPT, Industrial Interchange, 2/Case

3M Product Number W-3281-2 3M ID 7000051866 UPC 00051138289850

Details

A high pressure socket used on the 3M™ Compressed Air Filter and Regulator Panel W-2806
It is a 3/8 inch MPT brass fitting

Typical properties

Brands
3M™
CFM Capacity per Minute
50 CFM
Fitting Type
Industrial Interchange
Product Color
Brass
Product Series
Supplied Air
Product Type
Socket
Supplied Air Respirator Style
W-Series Fixed Panels
Valve Type
Air Regulating Valve

3M™ Socket W-3224-2/07158(AAD), 3/8 in Body Size, 3/8 in FPT, Industrial Interchange 2/Case

3M Product Number W-3224-2 3M ID 7000130990 UPC 50051138213867

Details

For use with 3M™ Whitecap Helmets

Typical properties

Brands

3M™

Case Quantity

2/bag

Product Color

Brass

Product Series

Whitecap

Product Type

Socket

Recommended Industry

Marine

Supplied Air Respirator Style

MST Portable and Fixed Panels, Versaflo™ AP-600 Portable Panels, W-Series
Fixed Panels

Dimensions and Classifications

Overall Length (Imperial)

3 in

Overall Length (Metric)

0.95 cm

3M™ Socket W-3280-2, 1/4 in Body Size, 1/4 in FPT, Industrial Interchange 2/Case

3M Product Number W-3280-2 3M ID 7000051867 UPC 00051138289867

Details

For use with 3M™ Whitecap Helmets

Typical properties

Brands

3M™

Case Quantity

2/case

Pressure Type

High

Product Color

Brass

Product Series

Whitecap

Product Type

Socket

Supplied Air Respirator Style

MST Portable and Fixed Panels, Versaflo™ AP-600 Portable Panels, W-Series

Fixed Panels

Dimensions and Classifications

Overall Length (Imperial)

1 in

Overall Length (Metric)

0.64 cm

3M™ Socket W-3185-2, 1/4 in Body Size, 1/4 in FPT, Schrader 2/Case

3M Product Number W-3185-2 3M ID 7000130790 UPC 50051138214819

Details

For use with 3M™ Whitecap Helmets

Typical properties

Brands

3M™

Case Quantity

2/bag

Product Color

Brass

Product Series

Whitecap

Product Type

Socket

Supplied Air Respirator Style

MST Portable and Fixed Panels, Versaflo™ AP-600 Portable Panels, W-Series

Fixed Panels

Dimensions and Classifications

Overall Length (Imperial)

1 in

Overall Length (Metric)

0.64 cm

3M™ Socket W-3184-2, 1/4 in Body Size, 1/4 in FPT, Industrial Interchange 2 EA/Case

3M Product Number W-3184-2 3M ID 7000056515 UPC 50051138214802

Details

For use with 3M™ Whitecap Helmets

Typical properties

Brands

3M™

Case Quantity

2/pack

Compatible With

3M™ Supplied Air Systems

Pressure Type

High

Product Color

Brass

Product Series

Whitecap

Product Type

Socket

Supplied Air Respirator Style

MST Portable and Fixed Panels, Versaflo™ AP-600 Portab

Dimensions and Classifications

Overall Length (Imperial)

1 in

Overall Length (Metric)

0.64 cm

3M™ Socket W-3182-2, 1/4 in Body Size, 3/8 in MPT, Schrader 2/Case

3M Product Number W-3182-2 3M ID 7000130788 UPC 50051138214789

Details

A high pressure, 3/8 inch MPT twist lock fitting that is used on the 3M™ Compressed Air Filter and Regulator Panel W-2806

Typical properties

Brands

3M™

Case Quantity

2/bag

Compatible With

3M™ W-2806 Filtration Panel

Product Color

Brass

Product Series

Supplied Air

Product Type

Socket

Supplied Air Respirator Style

MST Portable and Fixed Panels, Versaflo™ AP-600 Portable Panels, W-Se

Dimensions and Classifications

Overall Length (Imperial)

1 in

Overall Length (Metric)

0.64 cm

3M™ DBI-SALA® Energy Absorbing Lanyards

Details

Energy-absorbing lanyards are lanyard models that include an energy-absorbing component to help manage fall arrest forces

Equipped with 3M™ RFID

Protected labels

Typical properties

Anchor Connection Type

Comfort Grip Snap Hook, None, Rebar Hook, Snap Hook

Anchor Hook Material

Aluminum, Zinc Plated Steel

Brands

DBI-SALA®

Case Quantity

1

Connected Safety ID Equipped

Yes

Energy Absorber Class

6 ft (1.8 m) Free Fall/MAAF 900

Dimensions and Classifications

Overall Length (Imperial)

6 ft, 14.5 in

Overall Length (Metric)

1.83 m

3M™ Pressure Relief Valve W-1596 1 EA/Case

3M Product Number W-1596 3M ID 7100110738 UPC 00051138153717

Details

May be used with the carbon monoxide(CO) monitor in the 3M™ Portable Compressed Air Filter and Regulator Panel 256-02-00, 256-02-01 and the 3M™ Retrofit CO Monitor Kit W-2808. It provides an audible and visible indication outside the work area if the CO level exceeds the preset level

Typical properties

Brands
3M™
CFM Capacity per Minute
100 CFM, 50 CFM
Compatible With
3M™ Retrofit CO Monitor Kit W-2808
Product Color
Brass
Product Series
Supplied Air
Product Type
Valve
Supplied Air Respirator Style
W-Series Fixed Panels

3M™ Training and Fit Testing Kits

Details

Qualitative Fit test kit for particulate respirators
Kit includes hood, collar, 2 nebulizers, sensitivity solution, fit testing solution, and user instructions
For Occupational Use only

Typical properties

Accessories
Yes
Cartridge or Filter Included
No
Case Quantity
1
Clinical Area
Surgery
Product Type
Fit Test Kit, Training & Fit Test Kit
Purpose
Exclude
Recommended Application
Fit Testing
Recommended Industry
Marine
Solution Type
Bitter,

3M™ Virtua™ AP Safety Glasses

Details

Integrated side-shields provide additional protection
Wraparound design provides extended eye protection and unobstructed viewing
Contoured temples offer a snug fit
Polycarbonate lenses absorb 99.9% of UVA and UVB rays
Meets the Impact-Rated Protector requirement of the ANSI-ISEA Z87.1-2020 Standard

Typical properties

Anti Fog Lens
No, Yes
Case Quantity
20
Class
Economy
Comfort Features
Lightweight, Wraparound lens
Eyewear Range
Economy
Frame Color
Amber, Blue, Clear, Gray, Light Gray
Frame Material
Plastic
Frame Style
Frameless
Hard Coat Lens
No, Yes

3M™ SecureFit™ Protective Eyewear 200 Series

Details

3M's innovative temple design features slotted ribs that provide comfortable pressure equalization, allowing the temples to flex and self-adjust to the size of the wearer's head
Curved temples apply pressure to the less sensitive back of the head, instead of the temples, achieving a comfortable fit even during rapid head movement
Some models feature proprietary 3M™ Anti-Fog Plus Coating which resists fog up to 11x longer than traditional anti-fog coatings*, and through up to 10 washings with water
Lightweight design
Molded nose bridge
Choose from models with 3M™ Anti-Fog Plus Coating or 3M™ Scotchgard™ Protector Anti-Fog Coating
Models with blue accents help make eyewear more visible in food preparation/processing areas
U6 rated polycarbonate lenses absorb 99.9% of UVA, UVB, and UVC rays between 200 nm and 380 nm
Meets the Impact-Rated Protector requirement of the ANSI/ISEA-2020 Z87.1 Standard

Typical properties

Anti Fog Lens
Yes
Brands
SecureFit™
Case Quantity
20
Class
Economy, Value
Comfort Features
3M™ Pressure Diffusion Temple Technology
Frame Color
Amber, Blue, Clear, Gray
Frame Material
Plastic
Frame Style
Frameless
Gasket Included
No
Hard

Dimensions and Classifications

Overall Length (Imperial)
10 in

3M™ Versaflo™ TR-800 Series PAPR Systems

Details

The TR-800 is a PAPR blower with battery rated at Division I for Classes I, II, and III under the most current UL standard (UL 60079, 6th Edition, 2013); NIOSH-approved PAPR system.*

 *The 3M™ Versaflo™ Powered Air Purifying Respirator TR-800 Motor/Blower, with the 3M™ Battery Pack TR-830 attached, has been tested and classified for intrinsic safety in Hazardous Locations (Exia) by Underwriters Laboratory (UL) for the following: Exia Division 1: IS Class I, II, III; Division 1 (Includes Division 2), Groups C, D, E, F, G; T4; Ex ia I Ma; Class I, Zone 0, AEx ia IIB, T4; Class I, Zone 0, Ex ia IIB, T4; Zone 20, AEx ia IIIC, T135; Zone 20, Ex ia IIIC, T135; -20°C ≤ Ta ≤ 55° C

Battery includes a bumper to help absorb impact; mechanical attachment of the battery helps prevent removal during use

Audible and visual alarms alert users to low battery and low air flow

Loose-fitting headgear can help accommodate workers with limited facial hair and prescription eyewear

Compatible with particulate only filters or particulate and gas and vapor combination cartridges for protection in a variety of environments

Typical properties

Battery Life

4 - 8 Hours

Battery Type

Standard Capacity Lithium Ion - Rechargeable

Belt Type

Easy Clean, High Durability

Brands

Versaflo™

Breathing Tube Type

Back-Mounted

Cartridge or Filter Included

No, Yes

Cartridge or Filter Type

TR-6510N,

3M™ Health, Safety and Compliance Software Implementation, 1 Day

3M Product Number SIM-TRN-ONSITE 3M ID 6010002882

Details

Specialized training to expedite ROI and system adoption
We'll work with you to quickly setup your account, help you define checklists, and help you to begin to tag assets and conduct inspections
Learn best practices and help ensure proper implementation
Travel included for most locations
Select full day training sessions convenient to your schedule

Typical properties

Brands
3M™
Product Type
Services
Recommended Application
Connected Safety
Recommended Industry
Construction, Food & Beverage
Training Duration
8 hr
Training Type
On-site Training
eClass 14 Classification Group
25250000

3M™ DBI-SALA® Self Locking Carabiner

Details

User friendly compact design
Variable width gate opening steel or aluminum carabiner
Versatility of attachment to fall protection systems
Corrosion-resistant
Available in multiple sizes and shapes
Recommended for mining, oil and gas, utilities, wind energy, and general industrial applications
Meets the requirements of EN362 and ANSI/ASSP 359.12-2019
High-strength steel or aluminum construction
Durable and lightweight

Typical properties

Attachment Type
Hook, None
Carabiner/Hook Material
Stainless Steel
Case Quantity
1
Connected Safety ID Equipped
No
Dimensions
4.50x2.50x0.75in,6.90x3.80x0.75in
Gate Opening (Imperial)
2 in, 2.125 in
Gate Opening (Metric)
51 mm, 53.975 mm
Ins

Dimensions and Classifications

Overall Length (Metric)
124.46 mm

3M™ Protecta® Sliding Beam Anchor

Details

Compatible with various fall protection systems

Compact, lightweight design

Ideal for use with personal fall arrest systems with self-retracting lifelines

Recommended for use in the construction, general industrial, mining, oil and gas, transportation, utilities, and wind energy industries

Portable and reusable

Corrosion-resistant construction for durability

This safety equipment is designed for use with additional personal protective equipment (PPE)

Models designed to fit a variety of beam sizes

Fully adjustable integrated dual ratcheting adjustment system slides to fit snugly against the beam

Replaceable wear pads eliminate metal-to-metal contact and extend the usability of the product

Guarded locking mechanism located on the bottom to reduce chance of accidental disengagement

Typical properties

Anchor Hook Material

Metal

Anchor Hook Material

Metal

Anchor Install Type

Reusable

Anchor Type

I-Beam

Case Quantity

1 EA

Connected Safety ID Equipped

No

For Use With

3M™ DBI-SALA® SecuraSpan™ I-Beam System

Housing Material

Aluminum & Stainl

3M™ DBI-SALA® Salalift™II Winch

Details

- Manually operated winch
- Available in multiple lengths and lifeline material types
- 6:1 gear ratio
- Quick mount bracket included
- Free-wheel mode provides for ease of movement within the confined space
- Durable zinc-plated and anodized steel construction
- Reserve lifeline retention system
- Swiveling snap hook includes impact indicator
- Equipped with RFID

Typical properties

- Cable Length (Imperial)
50 ft, 60 ft, 120 ft
- Cable Length (Metric)
15.24 m, 18.288 m, 36.576 m
- Cable Material
Galvanized Steel, Stainless Steel, Technora Rope
- Carabiner/Hook Material
Zinc Plated Steel
- Case Quantity
1
- Connected Safety ID Equipped

Dimensions and Classifications

- Overall Length (Imperial)
50 ft, 60 ft, 90 ft, 120 ft
- Overall Length (Metric)
18 m, 27 m, 36 m, 36.5 m

3M™ DBI-SALA® SecuraSpan™ Pour-in-Place/Fasten-in-Place HLL Stanchion

7400203, 1 ea

Part Number 7400203 3M Product Number 7400203 3M ID 7100220294

Details

Durable materials stand up to harsh conditions
Portable design is durable, yet lightweight, for easy transport
Compatible with single-span and multi-span lifeline configurations
Equipped with RFID identification tag for convenient equipment tracking
Designed for use in Pour-in-Place Post Horizontal Lifeline Systems and fasten-in-place systems
This safety equipment is intended for use with additional personal protective equipment (PPE)
Meets OSHA requirements
Single-span systems hold up to 2 workers; multi-span systems hold up to 6 workers
Recommended for use in multiple industries including construction, facilities, general manufacturing, heavy infrastructure, and more

Typical properties

Brands
DBI-SALA®
Case Quantity
1
Connected Safety ID Equipped
Yes
For Use With
3M™ DBI-SALA® SecuraSpan™ Pour-in-Place/Fasten-in-Place HLL system
Install Type
Temporary/Portable
Lifeline Material
Order separately
Maximum Number of Workers
2 P

3M™ DBI-SALA® Rescue/Retrieval Web Y-Lanyard 1231470, 2 ft

Part Number 1231470 3M Product Number 1231470 3M ID 7012817060

Details

DBI-SALA equipment is designed for use with DBI-SALA approved components and subsystems only

This equipment is for use by persons with a combined weight (person, clothing, tools, etc.) of no more than 310 lbs. (140.6 kg.)

This equipment must be used by persons who have been properly trained in its correct application and use

Typical properties

Anchor Hook Material

Zinc Plated Steel

Brands

DBI-SALA®

Case Quantity

1

Connected Safety ID Equipped

Yes

Harness Connection Hook Material

Zinc Plated Steel

Harness Connection Type

Snap Hook

Lanyard Length (Imperial)

2 ft

Lanyard Material

Po

Dimensions and Classifications

Overall Length (Imperial)

2 ft

3M™ DBI-SALA® Sealed-Blok™ 3-Way Retrieval Self-Retracting Lifeline with Bracket 3400150, Stainless Steel Cable, Snap Hook, 50 ft

3M Product Number 3400150 3M ID 7100318433 UPC 00648250244197

Details

- Available in multiple configurations, lifeline lengths, and material types
- Critical SRL components sealed from environmental exposure
- Swiveling self-locking snap hook with impact indicator
- Pivoting anchorage connector loop
- Durable Construction
- Galvanized & stainless steel cable options
- Quick activating speed-sensing locking system
- Equipped with an integrated carrying handle to assist in transporting the SRL to job sites
- IP 69K ingress protection rating
- Integrated fall arrest energy dissipation system
- Emergency retrieval system available on some models
- RFID tag is embedded in polyurethane bumper
- Ergonomic cable handle equipped with 3M™ Connected Safety ID (CSID)

Typical properties

- ANSI Class Level
- Class 1
- Anchor Connection Type
- Carabiner
- Anchor Hook Material
- Stainless Steel
- Anchor Hook Material
- Stainless Steel
- Average Arrest Force (Imperial)
- 900 lbf (ANSI), 900 lbf (OSHA 130 lb - 310 lb)
- Average Arrest Force (Metric)
- 4 k

Dimensions and Classifications

- Overall Length (Imperial)
- 50 ft
- Overall Length (Metric)
- 15.2 m

3M™ DBI-SALA® Sealed-Blok™ 3 Retrieval Self-Retracting Lifeline 3400146, Rope, 30 ft.

3M Product Number 3400146 3M ID 7100333618 UPC 00648250244159

Details

- Available in multiple configurations, lifeline lengths, and material types
- Critical SRL components sealed from environmental exposure
- Swiveling self-locking snap hook with impact indicator
- Pivoting anchorage connector loop
- Durable Construction
- Galvanized & stainless steel cable options
- Quick activating speed-sensing locking system
- Equipped with an integrated carrying handle to assist in transporting the SRL to job sites
- IP 69K ingress protection rating
- Integrated fall arrest energy dissipation system
- Emergency retrieval system available on some models
- RFID tag is embedded in polyurethane bumper
- Ergonomic cable handle equipped with 3M™ Connected Safety ID (CSID)

Typical properties

- ANSI Class Level
- Class 1
- Anchor Connection Type
- Carabiner
- Anchor Hook Material
- Stainless Steel
- Average Arrest Force (Imperial)
- 900 lbf (ANSI), 900 lbf (OSHA 130 lb - 310 lb)
- Average Arrest Force (Metric)
- 4 kN (ANSI), 4 kN (OSHA 130 lb - 310 lb)

3M™ DBI-SALA® Sealed-Blok™ Self Retracting Lifeline 3400131, Stainless Steel Cable, 15 ft. (4.5 m)

3M Product Number 3400131 3M ID 7100306997 UPC 00648250244005

Details

- Available in multiple configurations, lifeline lengths, and material types
- Critical SRL components sealed from environmental exposure
- Swiveling self-locking snap hook with impact indicator
- Pivoting anchorage connector loop
- Durable Construction
- Galvanized & stainless steel cable options
- Quick activating speed-sensing locking system
- Equipped with an integrated carrying handle to assist in transporting the SRL to job sites
- IP 69K ingress protection rating
- Integrated fall arrest energy dissipation system
- Emergency retrieval system available on some models
- RFID tag is embedded in polyurethane bumper
- Ergonomic cable handle equipped with 3M™ Connected Safety ID (CSID)

Typical properties

- ANSI Class Level
- Class 1
- Anchor Connection Type
- Swivel Snap Hook
- Anchor Hook Material
- Zinc Plated Steel
- Anchor Hook Material
- Stainless Steel
- Average Arrest Force (Imperial)
- 900 lbf (ANSI), 900 lbf (OSHA 130 lb - 310 lb)
- Average Arrest Force (Met

Dimensions and Classifications

- Overall Length (Imperial)
- 15 ft
- Overall Length (Metric)
- 4.5 m

3M™ PELTOR™ COMTAC™ ACH Dual Comm Kit - SOCOM, Coyote Brown, 88901-00001 EA/Case

3M Product Number 88901-00000 3M ID 7010384664 UPC 00093045936144

Details

The PELTOR™ COMTAC™ is a trusted tactical communications and hearing protection headset that is field proven by law enforcement and militaries world wide

Helps provide protection from hazardous steady-state and impulse noise

Clear, intelligible two-way audio communications via radios and intercoms

Environmental listening (aka: "talk-through") for auditory situational awareness and face-to-face verbal conversation

Pre-assembled COMTAC kits include: Headset, adapter (PTT), bag, batteries, and gel ear cushions. Headband kits also include two oblong ZORBIUM® ACTION PADS (ZAP™) to accommodate headband headset integration within ground combat helmets

Meets the single hearing protection requirement listed in DA PAM 40-501 Army Hearing Conservation Program 2015 for both steady-state and impulse noise

Tested in accordance with MIL-STD-810F, Department of Defense Test Method Standard for Environmental Engineering Considerations and Laboratory Tests

Tested in accordance MIL STD 461E, Department of Defense Interface Standard, Requirements for the Control of Electromagnetic Interference

Characteristics of Subsystems and Equipment

Two AAA batteries provide approximately 500 hours of battery life

External communications and "talk-through" are battery independent for Rx/Tx fail safe. In the unlikely event of electronic failure or battery depletion, external communications will continue to function

Ambidextrous noise-canceling boom mic can be mounted on either left or right side by operator

Hearing Defender, Single COMM, and DUAL COMM configurations available

Multiple color options available

Suspension options: Headband, Back-band and Rail Attachment

Typical properties

Attenuation Rating

23 dB, 20 dB

Audio Type

Communication

Battery Life

Approx. 500 hours

Brands

PELTOR™

CSA Class

White

Communication Direction

Two-way

Communication Type

Tactical

Communication via External 2-Way Radio

3M™ PELTOR™ COMTAC™ ACH Single Comm Kit, SOCOM, Coyote Brown 88900-00000, 1 EA/Case

3M Product Number 88900-00000 3M ID 7010342079 UPC 00093045936151

Details

The PELTOR™ COMTAC™ is a trusted tactical communications and hearing protection headset that is field proven by law enforcement and militaries world wide

Helps provide protection from hazardous steady-state and impulse noise

Clear, intelligible two-way audio communications via radios and intercoms

Environmental listening (aka: "talk-through") for auditory situational awareness and face-to-face verbal conversation

Pre-assembled COMTAC kits include: Headset, adapter (PTT), bag, batteries, and gel ear cushions. Headband kits also include two oblong ZORBIUM® ACTION PADS (ZAP™) to accommodate headband headset integration within ground combat helmets

Meets the single hearing protection requirement listed in DA PAM 40-501 Army

Hearing Conservation Program 2015 for both steady-state and impulse noise

Tested in accordance with MIL-STD-810F, Department of Defense Test Method

Standard for Environmental Engineering Considerations and Laboratory Tests

Tested in accordance MIL STD 461E, Department of Defense Interface

Standard, Requirements for the Control of Electromagnetic Interference

Characteristics of Subsystems and Equipment

Two AAA batteries provide approximately 500 hours of battery life

External communications and "talk-through" are battery independent for Rx/Tx

fail safe. In the unlikely event of electronic failure or battery depletion, external communications will continue to function

Ambidextrous noise-canceling boom mic can be mounted on either left or right side by operator

Hearing Defender, Single COMM, and DUAL COMM configurations available

Multiple color options available

Suspension options: Headband, Back-band and Rail Attachment

Typical properties

Attenuation Rating

23 dB, 20 dB

Audio Type

Communication

Battery Life

Approx. 500 hours

Brands

PELTOR™

CSA Class

White

Communication Direction

Two-way

Communication Type

Tactical

Communication via External 2-Way Radio

3M™ DBI-SALA® Sealed-Blok™ Self Retracting Lifeline 3400147, Retrieval, Galvanized Cable, 50 ft. (15m)

3M Product Number 3400147 3M ID 7100313071 UPC 00648250244166

Details

- Available in multiple configurations, lifeline lengths, and material types
- Critical SRL components sealed from environmental exposure
- Swiveling self-locking snap hook with impact indicator
- Pivoting anchorage connector loop
- Durable Construction
- Galvanized & stainless steel cable options
- Quick activating speed-sensing locking system
- Equipped with an integrated carrying handle to assist in transporting the SRL to job sites
- IP 69K ingress protection rating
- Integrated fall arrest energy dissipation system
- Emergency retrieval system available on some models
- RFID tag is embedded in polyurethane bumper
- Ergonomic cable handle equipped with 3M™ Connected Safety ID (CSID)

Typical properties

- ANSI Class Level
- Class 1
- Anchor Connection Type
- Swivel Snap Hook
- Anchor Hook Material
- Zinc Plated Steel
- Anchor Hook Material
- Stainless Steel
- Average Arrest Force (Imperial)
- 1125 lbf (ANSI), 1125 lbf (OSHA 130 lb - 310 lb)
- Average Arrest Force (M)

Dimensions and Classifications

- Overall Length (Imperial)
- 50 ft
- Overall Length (Metric)
- 15.2 m

3M™ DBI-SALA® Sealed-Blok™ RSQ 3-Way Retrieval Self-Retracting Lifeline 3400165, Stainless Steel Cable, 50 ft

3M Product Number 3400165 3M ID 7012818933 UPC 00648250244340

Details

- Available in multiple configurations, lifeline lengths, and material types
- Critical SRL components sealed from environmental exposure
- Swiveling self-locking snap hook with impact indicator
- Pivoting anchorage connector loop
- Durable Construction
- Galvanized & stainless steel cable options
- Quick activating speed-sensing locking system
- Equipped with an integrated carrying handle to assist in transporting the SRL to job sites
- IP 69K ingress protection rating
- Integrated fall arrest energy dissipation system
- Emergency retrieval system available on some models
- RFID tag is embedded in polyurethane bumper
- Ergonomic cable handle equipped with 3M™ Connected Safety ID (CSID)

Typical properties

- ANSI Class Level
Class 1
- Anchor Connection Type
Carabiner
- Anchor Hook Material
Stainless Steel
- Anchor Hook Material
Stainless Steel
- Attachment Type
None
- Average Arrest Force (Imperial)
900 lbf (ANSI 130 lb - 310 lb), 900 lbf (OSHA 130 lb - 310)

3M™ DBI-SALA® Sealed-Blok™ RSQ Self-Retracting Lifeline 3400162, Stainless Steel Cable, 50 ft

3M Product Number 3400162 3M ID 7012818930 UPC 00648250244319

Details

- Available in multiple configurations, lifeline lengths, and material types
- Critical SRL components sealed from environmental exposure
- Swiveling self-locking snap hook with impact indicator
- Pivoting anchorage connector loop
- Durable Construction
- Galvanized & stainless steel cable options
- Quick activating speed-sensing locking system
- Equipped with an integrated carrying handle to assist in transporting the SRL to job sites
- IP 69K ingress protection rating
- Integrated fall arrest energy dissipation system
- Emergency retrieval system available on some models
- RFID tag is embedded in polyurethane bumper
- Ergonomic cable handle equipped with 3M™ Connected Safety ID (CSID)

Typical properties

- ANSI Class Level
Class 1
- Anchor Connection Type
Carabiner
- Anchor Hook Material
Stainless Steel
- Anchor Hook Material
Stainless Steel
- Attachment Type
None
- Average Arrest Force (Imperial)
900 lbf (ANSI 130 lb - 310 lb), 900 lbf (OSHA 130 lb - 310)

3M™ DBI-SALA® Sealed-Blok™ 3-Way Retrieval Self-Retracting Lifeline with Bracket 3400168, Stainless Steel Cable, 85 ft. OSHA

3M Product Number 3400168 3M ID 7100324055 UPC 00648250253366

Details

- Available in multiple configurations, lifeline lengths, and material types
- Critical SRL components sealed from environmental exposure
- Swiveling self-locking snap hook with impact indicator
- Pivoting anchorage connector loop
- Durable Construction
- Galvanized & stainless steel cable options
- Quick activating speed-sensing locking system
- Equipped with an integrated carrying handle to assist in transporting the SRL to job sites
- IP 69K ingress protection rating
- Integrated fall arrest energy dissipation system
- Emergency retrieval system available on some models
- RFID tag is embedded in polyurethane bumper
- Ergonomic cable handle equipped with 3M™ Connected Safety ID (CSID)

Typical properties

- Anchor Connection Type
- Swivel Snap Hook
- Anchor Hook Material
- Stainless Steel
- Anchor Hook Material
- Stainless Steel
- Attachment Type
- None
- Average Arrest Force (Imperial)
- 900 lbf (OSHA 130 lb - 310 lb), 900 lbf (OSHA up to 420 lb)
- Average Arrest For

3M™ DBI-SALA® Sealed-Blok™ 3-Way Retrieval Self-Retracting Lifeline 3400167, Stainless Steel Cable, 85 ft

3M Product Number 3400167 3M ID 7100323507 UPC 00648250253359

Details

- Available in multiple configurations, lifeline lengths, and material types
- Critical SRL components sealed from environmental exposure
- Swiveling self-locking snap hook with impact indicator
- Pivoting anchorage connector loop
- Durable Construction
- Galvanized & stainless steel cable options
- Quick activating speed-sensing locking system
- Equipped with an integrated carrying handle to assist in transporting the SRL to job sites
- IP 69K ingress protection rating
- Integrated fall arrest energy dissipation system
- Emergency retrieval system available on some models
- RFID tag is embedded in polyurethane bumper
- Ergonomic cable handle equipped with 3M™ Connected Safety ID (CSID)

Typical properties

- Anchor Connection Type
- Swivel Snap Hook
- Anchor Hook Material
- Stainless Steel
- Anchor Hook Material
- Stainless Steel
- Attachment Type
- None
- Average Arrest Force (Imperial)
- 900 lbf (OSHA 130 lb - 310 lb), 900 lbf (OSHA up to 420 lb)
- Average Arrest For

3M™ Scott™ Industrial SCBA (ISCBA)

3M ID B5005047159

Details

Durable sturdy wire-formed backframe for heavy duty use or applications
Wireframe allows for durability and quick and easy cleaning
The E-Z Flo regulator is designed for gloved hands, enables easy breathing, and has a two step secure attachment to help ensure worker confidence
NIOSH approved for use with 3M Scott AV series facepieces that can also be used for APR, PAPR, supplied air, and SCBA applications
Available in 2216 or 4500 psi variants and 30, 45 or 60 minute durations
Optional extended duration airline for added respirator versatility
Choice of harness style:
Nylon for chemical resistance
Kevlar for high heat environment or where there is potential for sparking

Typical properties

Brands
Scott™
Included Regulator
E-Z Flo
Product Type
Self-contained Breathing Apparatus

3M™ ForceFlex™ Safety Eyewear

3M ID 70006989456 UPC 00051141390628

Details

Durable lenses help provide limited protection for eyes from light to moderate impact hazards

Flexible frames self-adjust to help provide a secure, comfortable fit

Lightweight, durable design for all-day comfort and lasting wear

Soft rubber accents conform comfortably to different head sizes

Impact-resistant lenses block 99.9% of UV rays

Gray lenses help reduce sunlight and are popular for outdoor use

Meets the requirements of ANSI Z87.1 standards

Quantity: 1

Typical properties

Brands

Private Label

Factory ISO Certification

No ISO Certification information available

eClass 14 Classification Group

40230101

3M™ DBI-SALA® Permanent Multi-Span Horizontal Lifeline System

Details

Off the shelf permanent multi-span horizontal system designed for user installation
Metal energy absorber limits fall arrest forces
Flexible system capacity
Various lengths and individual components are available
Equipped with RFID
3/8 in. (9.5 mm) 7x19 galvanized or stainless steel cable lifeline
Bypassable intermediate brackets - one per 30 ft. (9.1m) span included (additional available model 7608001)
Sleeve provides easy operation (order model 7608002 separately)
Pass-thru 100% tie-off protection
Customizable multi-span configurations

Typical properties

Case Quantity
1
Connected Safety ID Equipped
Yes
Install Type
Permanent
Lifeline Length (Imperial)
20 ft, 80 ft, 100 ft, 120 ft, 140 ft, 160 ft, 180 ft
Lifeline Length (Metric)
6.09 m, 24.38 m, 30.47 m, 36.57 m, 42.66 m, 48.76 m, 54.86 m
Lifelin

Dimensions and Classifications

Overall Length (Imperial)
20 ft, 80 ft, 100 ft, 120 ft, 140 ft, 160 ft, 180 ft
Overall Length (Metric)
24.4 m, 30.5 m, 36.6 m, 42.7 m, 48.8 m, 54.9 m

3M™ DBI-SALA® Secondary Pad Air Hose 2200130

Part Number 2200130 3M Product Number 2200130 3M ID 7100226843

Details

Compact and lightweight aluminum design is easy to transport, install, and use
Provides a secure tie-off point on smooth, non-porous surfaces using vacuum technology

Approved for horizontal lifeline use

Heavy-duty storage and transport case

Secondary pad air hose for 3M™ DBI-SALA® Vacuum Anchor System

15m of 6.3mm diameter hose

Synthetic rubber construction

Rectus series 21 mini industrial couplings

Typical properties

Brands

DBI-SALA®

Case Quantity

1

Connected Safety ID Equipped

No

Net Weight (Imperial)

4.9 lb

Net Weight (Metric)

2.2 kg

Product Color

Black, Silver

Product Series

Mobi-Lok™

Product Type

Secondary Pad Air Hose

Recommended Industry

Constru

3M™ Clear Acetate Visor V3F-10P 10 EA/Case

3M Product Number V3F-10P 3M ID 7000103814 UPC 10093045936226

Details

Chemical resistant
Nose cutout
Polycarbonate faceshield is 5.5" x 12.125"
Must be attached to hard hat

Typical properties

Brands
PELTOR™
Case Quantity
10
For Use With
3M™ Peltor™ Cap-mounted Earmuffs, 3M™ Peltor™ Hard Hat Adapter P3EV/2
Product Type
Faceshield
Recommended Application
Assembly, Cleaning, Demolition, Electrical, Facility Maintenance, Grinding,
Machine

Dimensions and Classifications

Overall Height (Imperial)
5.5 in
Overall Height (Metric)
14 cm
Overall Length (Imperial)
34.29 in
Overall Length (Metric)
87.1 cm
Overall Width (Imperial)
5.5 in
Overall Width (Metric)
13.97 cm

3M™ Peltor™ Hard Hat Adapter for Visors P3EV/2, Face Protection 5 PAIR/Case

3M Product Number P3EV/2-10P 3M ID 7000103847 UPC 10093045936349

Details

Hard Hat Adapter

Typical properties

Brands
PELTOR™
Case Quantity
5
Compatible Hard Hat
H-700, H-700T, X5000
For Use With
3M™ Headgear Systems, Hard Hats
High Heat
Yes
Material
Nylon
Metal Detectable
No
Product Color
Black
Product Type
Visor Adapter
Recommended Industry
Au

Dimensions and Classifications

Overall Height (Imperial)
0.75 in
Overall Height (Metric)
1.91 cm
Overall Length (Imperial)
8.63 in
Overall Length (Metric)
21.91 cm
Overall Width (Imperial)
4.88 in
Overall Width (Metric)
12.38 cm

3M™ DBI-SALA® FlexiGuard™ C-Frame System, Adjustable Height

Details

Available in multiple adjustable size configurations
Outrigger support legs require some clearance under equipment being accessed
Aluminum and steel construction
Extruded aluminum rail minimizes maintenance and includes two trolleys
Conforms to OSHA 1926.502 and OSHA 1910.66 requirements
Suitable for numerous applications within the aviation, transportation, construction, and mining industries
One part of your fall protection system; intended for use with other personal protective equipment (PPE) including (but not limited to) harnesses and self retracting lifelines
System includes four 16 in foam-filled rubber wheels
System includes steel leveling jacks, with four 16 in. (40.6 cm) pneumatic wheels in the back and low profile 8 in. (20.3 cm) urethane caster wheels in the front
Accessories available to suit worksite needs including optional non-swiveling pneumatic wheels or tow bar kit

Typical properties

Case Quantity
1
Connected Safety ID Equipped
Yes
Install Type
Temporary/Portable
Maximum Height (Imperial)
19.58 ft, 29.63 ft, 39.63 ft
Maximum Height (Metric)
5.97 m, 9.03 m, 12.08 m
Maximum Number of Users
Two
Net Weight (Imperial)
1650 lb,

Dimensions and Classifications

Overall Width (Imperial)
10.57 ft, 15.52 ft, 20.52 ft
Overall Width (Metric)
3.22 m, 4.73 m, 6.25 m

3M™ Headgear

Details

Choose from ratchet or pinlock headgear styles
Allows for quick window replacement

Typical properties

Brands

3M™

Case Quantity

10

Compatible Hard Hat

H-700, H-700T

For Use With

Faceshield Attachment, Hard Hats, Hardhat Attachment, Ratchet Suspension, W Series Faceshields, WP98 Series Visors

Material

Aluminum, Polycarbonate, Thermoplastic

Product

Dimensions and Classifications

Overall Height (Imperial)

4 in, 5.3 in, 6 in, 6.5 in

Overall Height (Metric)

10.16 cm, 13.46 cm, 15.24 cm, 16.51 cm

Overall Length (Imperial)

9 in, 11.3 in

Overall Length (Metric)

22.86 cm, 28.702 cm

Overall Width (Imperial)

6 in, 9 in, 10 in, 10

3M™ Faceshield Cover H-110-10/07042(AAD) 10 ea/Bag

3M Product Number H-110-10 3M ID 7100138614 UPC 50051131070429

Details

For use with 3M™ H-Series hoods
Replacement part

Typical properties

Brands

3M™

Compatible With

3M™ H-Series Headgear

Headgear Type

Hood

High Heat

No

Product Color

Transparent

Product Series

H-Series

Product Type

Headgear Cover

Recommended Application

Assembly & Mechanical, Cleaning, Painting

Recommended In

3M™ PELTOR™ X1 Earmuffs X1P51E, Hard Hat Attached, 10 EA/Case

3M ID 7100135816 UPC 10078371671355

Details

Compatibility with full brim hard hats
Protects against arc flash and other electrical hazards with the electrically insulated (dielectric) attachment arms
Ensures prolonged, consistent protection resulting from durable attachment arms
Provides high level of protection relative to earcup depth
Low-profile cup design for improved compatibility with other personal protection equipment (PPE)

Typical properties

Attenuation Rating
20.0 Decibel
Bluetooth
No
Brands
PELTOR™
Corded
No
Dielectric
Yes
Earmuff Style
Hard Hat Attached
Electrically Insulated
Yes
Hearing Protection Style
Hard Hat Attached
Hearing Protection Type
Hard Hat Attached
Hygiene

3M™ PELTOR™ Earmuffs X1P5E, Forestry Orange, 10 EA/Case

3M Product Number X1P5E 3M ID 7100097447 UPC 10078371671171

Details

Electrically insulated: Appropriate for a wide range of applications*
Forestry Orange Color: Aligns with industry standard coloring
High-performance arms: Balance durability and flexibility
Easy click in/ click out: Move cups on and off ears easily
Convenient storage: Store with cups clicked in or out
Compatibility with hard hats: Designed for use with a standard hard hat slot**
Fit can be confirmed: Verify with 3M™ E-A-Rfit™ Dual-Ear Validation System***
X1 Products are slim and lightweight: Comfortable for wearers, especially with other protective equipment

*These earmuff cups are made of non-conductive (sometimes referred to as “dielectric”) material while the metal components of the headbands and the helmet attachment mechanisms are covered in non-conductive material. This product was found to be electrically insulated, withstanding a voltage up to 1.2 kV, at an external laboratory against a modified test method based on EN 397:2012 under dry conditions. The user must determine the overall suitability of this product for the intended application taking into account any hazards other than noise for which this product is tested and approved. **This product was designed and tested with a 3M Hard Hat H700. For information on other hard hat models contact 3M. ***3M strongly recommends fit testing of hearing protectors. Research suggests that many users will receive less noise reduction than indicated by the NRR due to variation in earmuff fit, earmuff fitting skill and motivation of the user. If NRR is used, 3M recommends that it be reduced by 50% or in accordance with applicable regulations

Typical properties

Attenuation Rating
21.0 Decibel
Brands
PELTOR™
Case Quantity
10
Earmuff Style
Hard Hat Attached
Electrically Insulated
Yes
Hearing Protection Style
Hard Hat Attached
Material
Foam Plastic Metal
Product Color
Black, Orange
Product Type
Ear

3M™ PELTOR™ X1 Earmuffs X1B, Behind-the-Head, 10 EA/Case

3M Product Number X1B 3M ID 7100123140 UPC 10078371671270

Details

Design of neckband allows earmuffs to be worn with a variety of face shields and headgear

Compatible with headgear without accessory slots

Soft, adjustable head strap helps to maintain a secure fit with many different types of headgear

Fit can be confirmed: Verify with 3M™ E-A-Rfit™ Dual-Ear Validation System***

X1 Products are slim and lightweight: Comfortable for wearers, especially with other protective equipment

Typical properties

Attenuation Rating

22.0 Decibel

Attenuation Rating (SNR)

22 Decibel

Bluetooth

No

Brands

PELTOR™

Case Quantity

10

Corded

No

Dielectric

No

Earmuff Style

Behind the Head

Electrically Insulated

No

Hearing Protection Style

Behind the Head, B

3M™ Protecta® Rope Adjuster with Lanyard

Details

Rope Grab for use on 5/8 in. (16 mm) rope
Mobile and manual options available to position in place or move along lifeline
Durable and lightweight construction
Cam locking system for safety

Typical properties

Attachment Type
None
Case Quantity
1
Connected Safety ID Equipped
No
Install Type
Temporary
Maximum Number of Users
One
Net Weight (Imperial)
2.5 lb, 3.4 lb
Net Weight (Metric)
1.1 kg, 1.5 kg
Product Operation
Manual
Product Series
PRO™

Dimensions and Classifications

Overall Length (Imperial)
2 ft

3M™ Solus™ 1000 Series Safety Glasses Kit

Details

3M™ Scotchgard™ Protector Anti-Fog Coating resists fogging longer than traditional anti-fog coatings through up to 25 washings with water* and helps provide scratch resistance in tough work environments. *Based on 3M internal testing per EN168 test method when compared with traditional anti-fog coatings
Kit models include removable temples, optional elastic strap and removable gasket (foam or TPE material)

Contemporary styling with padded temples and soft nosebridge for added comfort

U6 rated polycarbonate lenses absorb 99.9% of UVA, UVB, and UVC rays between 200 nm and 380 nm

Meets both the Impact-Rated Protector and Anti-Fog Performance (X) requirements of the ANSI-ISEA Z87.1-2020 Standard

Typical properties

3M Technology

Scotchgard Anti-Fog Coating

ANSI Requirements

ANSI Z87.1-2003 and CSA Z94.3-2007

Anti Fog Lens

Yes

Case Quantity

20

Comfort Features

Contains Foam Gasket, Dual-injected, Elastic Strap, Optional removable foam-lined gasket, Padded te

Dimensions and Classifications

Overall Height (Imperial)

2 in, 2.25 in

Overall Height (Metric)

5.08 cm, 5.715 cm

Overall Length (Imperial)

2 in, 2.25 in

Overall Length (Metric)

5.08 cm, 5.715 cm

Overall Width (Imperial)

2 in

Overall Width (Metric)

5.08 cm

3M™ PELTOR™ Hi-Viz Earmuffs H31A, Over-the-Head, 10 EA/Case

3M Product Number H31A 3M ID 7000141055 UPC 07318640051645

Details

Bright orange colored earcups for added visibility
Stainless steel construction resists bending and warping
Earcup pivot points tilt for optimum comfort and efficiency
Ultra light with liquid/foam filled earmuff cushions
Noise Reduction Rating (NRR)*: 23 dB. CSA Class A

Typical properties

Attenuation Rating
24.0 Decibel
Bluetooth
No
Brands
PELTOR™
Case Quantity
10
Corded
No
Dielectric
No
Earmuff Style
Over the Head
Electrically Insulated
No
Hearing Protection Style
Over-the-Head
Material
ABS
Metal Detectable
No
Moistu

3M™ PELTOR™ Hi-Viz Earmuffs H31P3E, Hard Hat Attached, 10 EA/Case

3M Product Number H31P3E 3M ID 7000141054 UPC 07318640051638

Details

Bright orange colored earcups for added visibility
Universal mounting attachment fits most hard hats
Earcup pivot points tilt for optimum comfort and efficiency
Ultra light with liquid/foam filled earmuff cushions
Noise Reduction Rating (NRR)*: 23dB. CSA Class A

Typical properties

Attenuation Rating
23.0 Decibel
Bluetooth
No
Brands
PELTOR™
Case Quantity
10
Corded
No
Dielectric
No
Earmuff Style
Hard Hat Attached
Electrically Insulated
No
Hearing Protection Style
Hard Hat Attached
Hearing Protection Type
cap-mount

3M™ Speedglas™ Welding Beanie 06-0500-54, 10 EA/Case

3M Product Number 06-0500-54 3M ID 7000127141 UPC 50051135893789

Details

Welding Beanie

Replacement Part

Typically replaced when the cap becomes unhygienic

Welding Cap to prevent unwanted debris from contacting the user's head

Typical properties

Brands

Speedglas™

Case Quantity

10

Material

Cotton

Product Color

Black

Product Series

9002NC, 9100, 9100 FX, 9100 FX-Air, 9100 MP, 9100 QR, 9100-Air, L-Series

Product Type

Welding Beanies

Recommended Application

Assembly, Facility Maintenance

3M™ E-A-R™ UltraFit™ Probed Test Plugs 393-2001-50, 50 EA/Case

3M Product Number 393-2001-50 3M ID 7000002387 UPC 10080529190748

Details

These test earplugs are modified with a probe tube for use during earplug fit testing with the 3M™ E-A-Rfit™ Validation System

50 PR Per Case

3M PSD products are for occupational use only

*The NRR may overestimate the hearing protection provided during typical use

Typical properties

Brands

E-A-R™

Case Quantity

50

Earplug Shape

Flanged

Material

Elastomeric Polymer

Product Color

Yellow

Product Series

E-A-Rfit

Product Type

Probed Test Earplug

Recommended Application

Health & Safety Testing

eClass 14 Classification Group

3M™ Breathing Tube Assembly 520-01-00R01, 1 EA/Case

3M Product Number 520-01-00R01 3M ID 7000131721 UPC 00051138720797

Details

This assembly is used with the 3M™ Breathe Easy™ 10 System
Delivers air to a butyl rubber hood used on the system
36 inches in length

Typical properties

Brands

3M™

Compatible With

3M™ Breathe Easy™ PAPR

Material

Vinyl

Product Color

Black

Product Series

Breathe Easy

Product Type

Breathing Tubes

Purpose

PAPR, Parts and Accessories, SAR

Dimensions and Classifications

Overall Length (Imperial)

36 in

Overall Length (Metric)

91.44 cm

3M™ Air-Mate™ Breathing Tube Assembly BE-224 (Formerly 008-00-14R01) Light Duty 1 EA/Case

3M Product Number BE-224 3M ID 7000005588 UPC 00051138720643

Details

Replacement part for Air-Mate powered air purifying respirator (PAPR) systems
Now NIOSH approved for use on certain 3M™ Versaflo PAPR systems (when using the BE-10 and BE-12 white hoods)

Typical properties

Brands
Air-Mate™
Product Color
Black
Product Series
Air-Mate
Product Type
Breathing Tubes

3M™ Retrofit CO Monitor Kit W-2808/37027(AAD), 1 EA/Case

Part Number 37027 3M Product Number W-2808 3M ID 7000126402

Details

This carbon monoxide(CO) monitor is designed to connect directly to the 3M™ Compressed Air Filter and Regulator Panel W-2806

Typical properties

Brands

3M™

CFM Capacity per Minute

100 CFM, 50 CFM

Case Quantity

1/case

Compatible With

3M™ W-2806 Filtration Panel

Intrinsically Safe

No

Pressure Type

High

Product Color

Black

Product Series

Supplied Air

Product Type

Carbon Monoxide Moni

3M™ Ratchet Suspension W-2879 1 EA/Case

3M Product Number W-2879 3M ID 7000126090 UPC 50051138291643

Details

For use with 3M™ Hoods H-Series

Typical properties

Brands

3M™

Compatible With

3M™ H-Series Headgear

Headgear Type

Hood

High Heat

No

Product Color

White

Product Series

H-Series

Product Type

Suspension

3M™ Versaflo™ Replacement Head Suspension M-150/37316(AAD), for M-100 Face Shields, 1 EA/Case

3M Product Number M-150 3M ID 7000127601 UPC 00051131373167

Details

Replacement part for 3M™ Versaflo™ M-100 Series Faceshields

Typical properties

Brands

Versaflo™

Case Quantity

1

Compatible With

3M™ Versaflo™ M-100 Faceshield

Headgear Type

Headtop with clear visor

High Heat

No

Product Color

Black

Product Series

M-Series

Product Type

Suspension

Recommended Industry

Marine

3M™ Versaflo™ Premium Head Suspension, S-950, for S-600 S-700 and S-800 Hood Assemblies, 1 EA/Case

3M Product Number S-950 3M ID 7100005445

Details

Additional accessories available
Reuseable head suspension for certain S-Series head gear

Typical properties

Brands
Versaflo™
Compatible With
3M™ Versaflo™ S-800 Hood Assembly
Headgear Type
Head Suspension
High Heat
No
Mounting Type
Head-mounted
Product Color
Gray
Product Series
S-Series
Product Type
Suspension
Recommended Application
Assembly &

3M™ Head Suspension W-2878-2/07041(AAD), 2/Case

Part Number W28782 3M Product Number W-2878-2 3M ID 7000130787

Details

Designed to be used with 3M™ H-Series Hoods, Whitecap™ Helmets and Hardcap Assemblies

Typical properties

Brands

3M™

Compatible With

3M™ Hardcap Assemblies

Headgear Type

Hood

High Heat

No

Product Color

White

Product Series

H-Series, Whitecap

Product Type

Suspension

3M™ Span Gas Cylinder 529-05-16, Large, 1 EA/Case

3M Product Number -500610 3M ID 7000126386 UPC 00051138727895

Details

Contains 3.6 cubic feet of gas
Replacement span gas cylinder for the 3M™ Calibration Kit 529-04-48

Typical properties

Brands
3M™
CFM Capacity per Minute
100 CFM, 50 CFM
Case Quantity
1/case
Product Color
Cream
Product Series
Supplied Air
Product Type
Gas Cylinder
Supplied Air Respirator Style
MST Portable and Fixed Panels

3M™ Span Gas Cylinder 529-05-19, 1 EA/Case

3M Product Number -500607 3M ID 7000131707 UPC 00051138720155

Details

Contains 3.6 cubic feet of gas
Replacement span gas cylinder for the 3M™ Calibration Kit 529-04-48

Typical properties

Brands
3M™
CFM Capacity per Minute
100 CFM, 50 CFM
Case Quantity
1/case
Product Color
Cream
Product Series
Supplied Air
Product Type
Gas Cylinder
Supplied Air Respirator Style
MST Portable and Fixed Panels

3M™ Solus™ CCS Series Safety Glasses

Details

Features a Cord Control System (CCS) that helps keep eyewear and earplugs attached, untangled and ready to use
3M™ Scotchgard™ Protector Anti-Fog Coating resists fogging longer than traditional anti-fog coatings through up to 25 washings with water* and helps provide scratch resistance in tough work environments. *Based on 3M internal testing per EN168 test method when compared with traditional anti-fog coatings
Contemporary styling with soft nosebridge for added comfort
Small vents in the optional foam gasket help minimize fogging
U6 rated polycarbonate lenses absorb 99.9% of UVA, UVB, and UVC rays between 200 nm and 380 nm
Workers can feel confident wearing 3M eye protection that meets the Impact-Rated Protector requirement of the ANSI-ISEA Z87.1 Standard

Typical properties

Anti Fog Lens

Yes

Brands

Solus™

Case Quantity

20

Comfort Features

Contains foam gasket attachment, Cord Control System, Cord Control System

Temples for Earplug Attachment, Cushioned Foam Liner, Direct Ventilation,

Polycarbonate lens

Eyewear Range

3M™ Buckle FF-400-01, 30 EA/Case

3M Product Number FF-400-01 3M ID 7000052734 UPC 50051135894731

Details

Replacement part to use with 3M Ultimate FX Full Facepiece Reusable Respirators FF-401, FF-402, and FF-403 (sold separately)
Includes six head harness buckles
Pack includes six head harness buckles
Made of durable plastic
Replaceable part can potentially result in respiratory equipment cost savings

Typical properties

Accessories
Yes
Boxes per Case
30
Brands
3M™
Case Quantity
30/case
Clip-on Welding Shield
No
Compatible Respirator
FF-800 Series
Compatible with 3M™ PAPR Systems
No
Compatible with 3M™ Supplied Air System
Yes
Compatible with Welding Shield

3M™ Shroud 7915-5/7915-5-AM, Accessory 5 EA/Case

3M Product Number 7915-5/7915-5-AM 3M ID 7000126022 UPC 50051138215557

Details

Shroud protects head and shoulders from dust and debris
Recommended for use with 3M Full Facepieces 7000 Series (sold separately)
Lightweight material offers comfort
Recommended for paint and other spray applications
Approved 3M respiratory protection accessory

Typical properties

Accessories
No
Boxes per Case
5
Brands
3M™
Case Quantity
5/case
Clip-on Welding Shield
No
Compatible with 3M™ PAPR Systems
No
Compatible with 3M™ Supplied Air System
No
Compatible with Welding Shield
No
Cool Flow™ Exhalation Valve
No
Dro

3M™ Professional Series Half Facepiece Paint Spray Packout 37078, Medium 4 EA/Case

Part Number 37078 3M ID 7010384301 UPC 00051131370784

Details

Packout includes: Half Facepiece 7502/37082(AAD), Medium, 1 pair 3M™ Organic Vapor Cartridge 07046, 1 pair 3M™ Retainer 07054, and 2 pairs of 3M™ Particulate Filter 5P71/07194(AAD), P95 swept back cartridge design
Spray paint applications
For occupational use only

Typical properties

Brands
3M™
Connection Type
Bayonet
Facepiece Material
Silicone
Mask Size
Medium
Recommended Industry
Marine
Replaceable Cartridge Included
Yes
eClass 14 Classification Group
40220112

3M™ Half Facepiece Respirator Packout PN 07183, Large, with 3M™ Particulate Filters PN 07184, P100

Part Number 07183 3M ID 7000126241 UPC 00051131071834

Details

P100 Filter

Nuisance level relief against organic vapours, and ozone protection up to 10 times the Occupational Exposure Limit (OEL)

Not NIOSH approved for use against ozone

Packout includes: 1 half facepiece respirator and 2 pairs P100 filters (07184)

Typical properties

Brands

3M™

Connection Type

Bayonet

Facepiece Material

Thermoplastic Elastomer (TPE)

Mask Size

Large

Product Type

Half Facepiece

Recommended Industry

Marine

Replaceable Cartridge Included

Yes

eClass 14 Classification Group

40220112

3M™ Half Facepiece Respirator Packout 07182, Medium, with 3M™ Particulate Filters PN 07184, P100

Part Number 07182 3M ID 7000126240 UPC 00051131071827

Details

P100 Filter

Nuisance level relief against organic vapours, and ozone protection up to 10 times the Occupational Exposure Limit (OEL)

Not NIOSH approved for use against ozone

Packout includes: 1 half facepiece respirator and 2 pairs P100 filters (07184)

Typical properties

Brands

3M™

Connection Type

Bayonet

Facepiece Material

Thermoplastic Elastomer (TPE)

Mask Size

Medium

Product Type

Half Facepiece

Recommended Industry

Marine

Replaceable Cartridge Included

Yes

eClass 14 Classification Group

40220112

3M™ Speedglas™ G5-01 Task Light Kit, including Light, Protection Plate, and Cables, 46-0500-01, 1 EA/Bag

3M Product Number 46-0500-01 3M ID 7100217200 UPC 00076308944742

Details

Used to illuminate work piece or to help light up dark working environments

Contains many servicable parts

May reduce the battery run time of the 3M™ Adflo™ Powered Air Respirator

For maximum safety and comfort, make it a habit to check your equipment regularly

Replace worn out or damaged parts

Typical properties

Brands

Speedglas™

Compatible Welding Helmet

G5-01 Welding Helmets

Product Color

Black

Product Series

G5

Product Type

Task Light Kit

Recommended Application

Grinding, Metal Processing, Metal Repair, Welding

Recommended Industry

General Manufac

3M™ Speedglas™ G5 Non-Air Welding Helmet Task Light Kit 10-0500-01, including Light, Battery, and Cables, 1 EA/Case

3M Product Number 10-0500-01 3M ID 7100311951

Details

Light up work space

Used to illuminate work piece or to help light up dark working environments

Contains many servicable parts

May reduce the battery run time of the 3M™ Adflo™ Powered Air Respirator

Typical properties

Battery Type

Lithium-Ion

Brands

Speedglas™

Compatible Welding Helmet

G5-01 Welding Helmets, G5-03 Series

Headgear Type

Welding Helmet

Part Type

Accessory

Product Series

G5

Product Type

Task Light Kit

eClass 14 Classification Group

40300190

3M™ Speedglas™ G5 Replacement Task Light 46-0500-06, No Power Cables Included

3M Product Number 46-0500-06 3M ID 7100314379 UPC 00638060430774

Details

Spare part

Used to illuminate work piece or to help light up dark working environments

Contains many servicable parts

May reduce the battery run time of the 3M™ Adflo™ Powered Air Respirator

Typical properties

Brands

Speedglas™

Compatible Welding Helmet

G5-01 Welding Helmets

Part Type

Spare Part

Product Series

G5

Product Type

Task Light

eClass 14 Classification Group

40300190

3M™ Speedglas™ G5 Non-Air Welding Helmet Task Light Battery Holder 10-0500-03

3M Product Number 10-0500-03 3M ID 7100312001 UPC 00638060430675

Details

Spare part

Used to illuminate work piece or to help light up dark working environments

Contains many servicable parts

May reduce the battery run time of the 3M™ Adflo™ Powered Air Respirator

Typical properties

Brands

Speedglas™

Compatible Welding Helmet

G5-01 Welding Helmets, G5-03 Series

Headgear Type

Welding Helmet

Part Type

Spare Part

Product Series

G5

Product Type

Battery Holder

eClass 14 Classification Group

40300190

3M™ E-A-RSoft™ FX™ Probed Test Plugs 393-2004-50, 50 EA/Case

3M Product Number 393-2004-50 3M ID 7000052883 UPC 10080529190779

Details

These test earplugs are modified with a probe tube for use during earplug fit testing with the 3M™ E-A-Rfit™ Validation System

50 PR Per Case

3M PSD products are for occupational use only

*The NRR may overestimate the hearing protection provided during typical use

Typical properties

Brands

3M™

Case Quantity

50

Earplug Shape

Bell

Material

Polyurethane

Product Color

Neon Green

Product Series

E-A-Rfit

Product Type

Probed Test Earplug

Recommended Application

Health & Safety Testing

eClass 14 Classification Group

40270102

3M™ Scotchlite™ Reflective Tape, 03459, 2 in x 36 in, 24 per case

Part Number 03459 3M ID 60455056972 UPC 00051131034594

Details

Tape may be used wherever low light or night-time light reflectivity is needed to increase visibility

Versatile tape works on a variety of SURFACES on automobiles, trailers, driveways, mailboxes, RVs, watercraft and bicycles

When you shine light this tape, the light reflects back toward the source of the light, immediately alerting people to objects up ahead

Pressure-sensitive adhesive adheres to clean, smooth surfaces such as metal, glass, smooth wood or painted surfaces

WEATHERABLE Adhesive bonds well in exterior applications

Use tape to alert drivers about stationary objects such as fences, posts, walls, rails, mailboxes and poles

Reflective tape is also good to apply to clothing, bikes and helmets used in low light conditions

Conformability allows for use on most contoured and curved surfaces

Visibility/identification tape for enhanced nighttime reflective brightness

Apply and obtain adhesion at any temperature above 50°F/10°C

Typical properties

Brands

Scotchlite™

Case Quantity

6.0 Cartons per Case

Daytime Color

Fluorescent Red-Orange

Factory ISO Certification

No ISO Certification information available

Product Color

Red

eClass 14 Classification Group

35030590

Dimensions and Classifications

Overall Length (Imperial)

36 in

Overall Length (Metric)

91.44 cm

Overall Width (Imperial)

2 in

Overall Width (Metric)

5 cm

3M™ Scotchlite™ Reflective Tape, 03456, 2 in x 36 in, 24 per case

Part Number 03456 3M ID 60455056964 UPC 00051131034563

Details

Tape may be used wherever low light or night-time light reflectivity is needed to increase visibility

Versatile tape works on a variety of SURFACES on automobiles, trailers, driveways, mailboxes, RVs, watercraft and bicycles

When you shine light this tape, the light reflects back toward the source of the light, immediately alerting people to objects up ahead

Pressure-sensitive adhesive adheres to clean, smooth surfaces such as metal, glass, smooth wood or painted surfaces

WEATHERABLE Adhesive bonds well in exterior applications

Use tape to alert drivers about stationary objects such as fences, posts, walls, rails, mailboxes and poles

Reflective tape is also good to apply to clothing, bikes and helmets used in low light conditions

Conformability allows for use on most contoured and curved surfaces

Visibility/identification tape for enhanced nighttime reflective brightness

Apply and obtain adhesion at any temperature above 50°F/10°C

Typical properties

Brands

Scotchlite™

Case Quantity

6.0 Packs per Case

Daytime Color

Silver

Factory ISO Certification

No ISO Certification information available

Product Color

Silver

eClass 14 Classification Group

35030590

Dimensions and Classifications

Overall Length (Imperial)

36 in

Overall Width (Imperial)

2 in

3M™ Speedglas™ Magnifying Lens Holder 05-0680-00, for SL Series Welding Helmets, 1 EA/Case

3M Product Number 05-0680-00 3M ID 7100077601 UPC 00051131172159

Details

Lens Holder
Replacement Part

Typical properties

Brands
Speedglas™
Case Quantity
1
Compatible Welding Helmet
SL Series
Features
Magnification Plate
Product Series
SL
Recommended Application
Assembly, Facility Maintenance, Grinding, Machine Operation, Sanding, Welding
Recommended Industry
Co

3M™ Speedglas™ Magnifying Lens Holder 07-0680-00, for 100 Series Welding Helmets, 2 EA/Case

3M Product Number 07-0680-00 3M ID 7000127452 UPC 50051131171959

Details

Magnifying Lens Holder
Replacement Part

Typical properties

Brands

Speedglas™

Case Quantity

2

Compatible Welding Helmet

100 Series

Features

Magnification Plate

Product Series

100

Recommended Application

Assembly, Facility Maintenance, Grinding, Machine Operation, Sanding, Welding

Recommended Industry

3M™ PELTOR™ CH-3 Headset MT74H52B-110, Neckband, FLX2, 1 ea/Case

3M Product Number MT74H52B-110 3M ID 7100203636 UPC 04054596695603

Details

Protective communication solution for hands-free, clear communication in noisy environments
FLX2 connection jack for easy and reliable connection to a wide assortment of handheld devices
Lasting comfort for long duration wear times
Designed to withstand harsh environmental elements
Water and dust-proof noise-cancelling microphone (IP68) for clear speech transmission in noisy and harsh environments
Audio speakers are optimized for speech frequencies and meet the efficiency demands of many of today's digital devices
Bright yellow color for enhanced visibility
Flexible yet sturdy neckband design adapts to a wide variety of head shapes and sizes, and can be worn with most hard hats

Typical properties

Attenuation Rating
24 dB
Audio Type
Communication
Auxiliary Port
FLX2
Brands
PELTOR™
CSA Class
CSA Class A
Case Quantity
1
Communication Direction
Two-way
Communication Type
External Audio Input
Communication via External 2-Way Radio
Yes

3M™ PELTOR™ CH-3 Headset MT74H52P3E-110, Hard Hat Attached, FLX2, 1 ea/Case

3M Product Number MT74H52P3E-110 3M ID 7100203635 UPC 04054596695634

Details

Protective communication solution for hands-free, clear communication in noisy environments

FLX2 connection jack for easy and reliable connection to a wide assortment of handheld devices

Lasting comfort for long duration wear times

Designed to withstand harsh environmental elements

Water and dust-proof noise-cancelling microphone (IP68) for clear speech transmission in noisy and harsh environments

Audio speakers are optimized for speech frequencies and meet the efficiency demands of many of today's digital devices

Bright yellow color for enhanced visibility

Flexible yet sturdy hard hat attachment design adapts to a wide variety of head shapes and sizes, and fits most slotted hard hats

Typical properties

Attenuation Rating

24 dB

Audio Type

Communication

Auxiliary Port

FLX2

Brands

PELTOR™

CSA Class

CSA Class A

Case Quantity

1

Communication Direction

Two-way

Communication Type

External Audio Input

Communication via External 2-Way Radio

Yes

3M™ Speedglas™ FA III SAR with V-100 Valve and 9100-Air Welding Helmet 25-5702-30iSW, ADF 9100XXi, 1 EA/Case

3M Product Number 25-5702-30iSW 3M ID 7010342473 UPC 00051141564777

Details

3M™ Speedglas™ Welding Helmet 9100-Air with customizable head suspension
Belt-mounted V-100 air-cooling valve lowers headgear temperature by up to 50°F (28°C)

APF of 25 helps reduce exposure to particles and vapors

Speedglas™ XXi auto-darkening filters (ADF) provide great contrast and natural-looking colors

Side windows allow for better peripheral vision

Requires grade D, breathable air source

Applications include assembly, facility maintenance, grinding, machine operations, sanding, and welding

Meets requirements of ANSI Z87.1-2010 and NIOSH

Typical properties

ADF Dark State Shades

Variable 5, 8-13

ADF Model

9100XXi

ADF Shade Range

Variable 5, 8-13

ADF Viewing Area (Metric)

73 mm x 107 mm

ADF Viewing Area (hwx)

2.8x4.2in

Air Source

SAR

Battery Life

ADF: up to 1800 Hours

Battery Type

ADF: CR2032

3M™ Speedglas™ FA III SAR V-100 Valve and Speedglas™ Welding Helmet

9100-Air, 25-5702-00SW (No ADF), 1 EA/CS

3M Product Number 25-5702-00SW 3M ID 7100194537 UPC 00051131277830

Details

3M™ Speedglas™ Welding Helmet 9100-Air with customizable head suspension
Belt-mounted V-100 air-cooling valve lowers headgear temperature by up to 50°F (28°C)

APF of 25 helps reduce exposure to particles and vapors

Speedglas™ XXi auto-darkening filters (ADF) provide great contrast and natural-looking colors

Side windows allow for better peripheral vision

Requires grade D, breathable air source

Applications include assembly, facility maintenance, grinding, machine operations, sanding, and welding

Meets requirements of ANSI Z87.1-2010 and NIOSH

Typical properties

ADF Shade Range

None

Air Source

SAR

Brands

Speedglas™

Dark Shades

Shade 5, 8-13

Features

Advanced Headgear

Headgear Type

Welding Helmet with Respiratory Assembly

Includes

Carry Bag, Supplied Air Valve, Breathing Tube, Welding Helmet

Lens Typ

3M™ Modul-R™ Safety Goggle, 40658-00000-10 Clear Anti Fog Lens with Chin Protector 10 ea/case

3M ID 7000030008 UPC 10078371620971

Details

Neoprene strap pivots for added adjustability
Low profile visor attaches directly to goggle and can be flipped up in stand-by position
Open-closed venting system helps minimize fogging
Meets the Impact-Rated Protector requirement of the ANSI-ISEA Z87.1-2020 Standard

Typical properties

Anti Fog Lens

Yes

Brands

Modul-R™

Case Quantity

10

Class

Value

Comfort Features

Flexible strap, Flip-up chin guard/visor, Open/close venting on visor, Splash shield, Strap pivots, Wide viewing area

Eyewear Range

Value

Frame Color

Clear

Frame

3M™ Protecta® Dual-Ring Cable Tie-Off Adaptor

Details

Portable and reusable
Meets the requirements for ANSI/ASSP Z359.18, 29 CFR OSHA 1910.140 and 29 CFR OSHA 1926.502
Recommended for use in multiple industries including construction, mining, and oil and gas
Compact and lightweight design
High strength steel O-ring hardware
Variable length cable tie-off adaptor
Durable 1/4 in. (6.3 mm) 7x19 galvanized steel cable
Unique dual-ring design is easily repositioned
Two high strength steel D-rings at one end
Self locking and closing steel carabiner at one end
Replaces incompatible "basket" type configurations

Typical properties

Anchor Install Type
Reusable
Attachment Type
Hook
Carabiner/Hook Material
Zinc Plated Steel
Case Quantity
1
Connected Safety ID Equipped
No
Install Type
Reusable
Material
Galvanized Steel
Product Color
Silver
Product Series
PRO™
Product

Dimensions and Classifications

Overall Length (Imperial)
3 ft, 4 ft, 6 ft, 8 ft, 10 ft

3M™ DBI-SALA® Steel Structure Remote Anchor System 2104810, 80 ft

Part Number 2104810 3M Product Number 2104810 3M ID 7012818347

Details

Rugged and corrosion resistant material construction for durability with compact and lightweight design

High strength steel construction

This safety equipment is designed for use with additional personal protective equipment (PPE)

Compatible with various fall arrest systems

Recommended for use in the construction, general industrial, mining, oil and gas, transportation, utilities, and wind energy industries

Allows user to easily work around obstructions

Compact and lightweight design

Includes anchor tube with installation/removal tool

Typical properties

Anchor Install Type

Reusable

Attachment Type

Pass-through/Choker

Brands

DBI-SALA®

Case Quantity

1

Connected Safety ID Equipped

Yes

Install Type

Reusable

Material

Polyolefin Rope

Product Series

Saflok™

Product Type

Steel Structure Remote A

3M™ DBI-SALA® ExoFit™ Tongue Buckle Belt 1000716, Gray, Large

Part Number 1000716 3M Product Number 1000716 3M ID 7012815012

Details

Body belts available in designs to be used independently, as well as other versions to be used with 3M Fall Protection Harnesses
Multiple sizes available
Meets applicable regulatory standards

Typical properties

Belly Pad
No
Belt Type
Waist
Board/Seat Cushion
No
Brands
DBI-SALA®
Buckle Material
Stainless Steel Grommet
Buckle Type
Tongue Buckle
Case Quantity
1
Connected Safety ID Equipped
Yes
Hip Pad
No
Material
Polyester
Max Free Fall Allowed

3M™ DBI-SALA® Tongue Buckle Restraint Belt 1000165, Yellow, X-Large

3M Product Number 1000165 3M ID 7012814969 UPC 00648250165430

Details

Body belts available in designs to be used independently, as well as other versions to be used with 3M Fall Protection Harnesses

Multiple sizes available

Meets applicable regulatory standards

Typical properties

Belly Pad

No

Belt Type

Waist

Board/Seat Cushion

No

Brands

DBI-SALA®

Buckle Material

Stainless Steel Grommet

Buckle Type

Tongue Buckle

Case Quantity

1

Connected Safety ID Equipped

Yes

D-ring Material

Zinc Plated Steel

D-ring Placement

FI

3M™ DBI-SALA® Tongue Buckle Positioning Belt with Hip Pad 1000023, Yellow, Medium

3M Product Number 1000023 3M ID 7012814940 UPC 00840779004379

Details

Body belts available in designs to be used independently, as well as other versions to be used with 3M Fall Protection Harnesses

Multiple sizes available

Meets applicable regulatory standards

Typical properties

Belly Pad

No

Belt Type

Waist

Board/Seat Cushion

No

Brands

DBI-SALA®

Buckle Material

Stainless Steel Grommet

Buckle Type

Tongue Buckle

Case Quantity

1

Connected Safety ID Equipped

Yes

D-ring Material

Zinc Plated Steel

D-ring Placement

Si

3M™ DBI-SALA® Tongue Buckle Restraint Belt 1000615, Yellow, Large

3M Product Number 1000615 3M ID 7012815002 UPC 00840779004423

Details

Body belts available in designs to be used independently, as well as other versions to be used with 3M Fall Protection Harnesses

Multiple sizes available

Meets applicable regulatory standards

Typical properties

Belly Pad

No

Belt Type

Waist

Board/Seat Cushion

No

Brands

DBI-SALA®

Buckle Material

Stainless Steel Grommet

Buckle Type

Tongue Buckle

Case Quantity

1

Connected Safety ID Equipped

Yes

D-ring Material

Zinc Plated Steel

D-ring Placement

Ba

3M™ DBI-SALA® Tongue Buckle Belt 1000054, Yellow, Large

Part Number 1000054 3M Product Number 1000054 3M ID 7012814952

Details

Body belts available in designs to be used independently, as well as other versions to be used with 3M Fall Protection Harnesses
Multiple sizes available
Meets applicable regulatory standards

Typical properties

Belly Pad
No
Belt Type
Waist
Board/Seat Cushion
No
Brands
DBI-SALA®
Buckle Material
Stainless Steel Grommet
Buckle Type
Tongue Buckle
Case Quantity
1
Connected Safety ID Equipped
Yes
Hip Pad
No
Material
Polyester/Nylon
Max Free Fall Al

3M™ DBI-SALA® Tongue Buckle Belt 1000053, Yellow, Medium

Part Number 1000053 3M Product Number 1000053 3M ID 7012814951

Details

Body belts available in designs to be used independently, as well as other versions to be used with 3M Fall Protection Harnesses
Multiple sizes available
Meets applicable regulatory standards

Typical properties

Belly Pad
No
Belt Type
Waist
Board/Seat Cushion
No
Brands
DBI-SALA®
Buckle Material
Stainless Steel Grommet
Buckle Type
Tongue Buckle
Case Quantity
1
Connected Safety ID Equipped
Yes
Hip Pad
No
Material
Polyester/Nylon
Max Free Fall Al

3M™ DBI-SALA® Tongue Buckle Restraint Belt 1000617, Yellow, 2X

Part Number 1000617 3M Product Number 1000617 3M ID 7012815005

Details

Body belts available in designs to be used independently, as well as other versions to be used with 3M Fall Protection Harnesses
Multiple sizes available
Meets applicable regulatory standards

Typical properties

Belly Pad
No
Belt Type
Waist
Board/Seat Cushion
No
Brands
DBI-SALA®
Buckle Material
Stainless Steel Grommet
Buckle Type
Tongue Buckle
Case Quantity
1
Connected Safety ID Equipped
Yes
D-ring Material
Zinc Plated Steel
D-ring Placement
Ba

3M™ DBI-SALA® Parachute Buckle Web Boom Belt 1001250, Polyester, 4 ft

3M ID 7012815087

Details

Body belts available in designs to be used independently, as well as other versions to be used with 3M Fall Protection Harnesses

Multiple sizes available

Meets applicable regulatory standards

Typical properties

Brands

DBI-SALA®

3M™ DBI-SALA® Tongue Buckle Positioning Belt with Hip Pad 1000027, Yellow, 3X

Part Number 1000027 3M Product Number 1000027 3M ID 7012814948

Details

Body belts available in designs to be used independently, as well as other versions to be used with 3M Fall Protection Harnesses

Multiple sizes available

Meets applicable regulatory standards

Typical properties

Belly Pad

No

Belt Type

Waist

Board/Seat Cushion

No

Brands

DBI-SALA®

Buckle Material

Stainless Steel Grommet

Buckle Type

Tongue Buckle

Case Quantity

1

Connected Safety ID Equipped

Yes

D-ring Material

Zinc Plated Steel

D-ring Placement

Si

3M™ DBI-SALA® ExoFit NEX™ Tongue Buckle Belt 1000779, Gray, Small

Part Number 1000779 3M Product Number 1000779 3M ID 7012815022

Details

Body belts available in designs to be used independently, as well as other versions to be used with 3M Fall Protection Harnesses

Multiple sizes available

Meets applicable regulatory standards

Typical properties

Belly Pad

No

Belt Type

Waist

Board/Seat Cushion

No

Brands

DBI-SALA®

Buckle Material

Stainless Steel Grommet

Buckle Type

Tongue Buckle

Case Quantity

1

Connected Safety ID Equipped

Yes

Hip Pad

No

Material

Polyester

Max Free Fall Allowed

3M™ DBI-SALA® Tongue Buckle Restraint Belt with Hip Pad 1000009, Yellow, 5X

Part Number 1000009 3M Product Number 1000009 3M ID 7012814935

Details

Body belts available in designs to be used independently, as well as other versions to be used with 3M Fall Protection Harnesses

Multiple sizes available

Meets applicable regulatory standards

Typical properties

Belly Pad

No

Belt Type

Waist

Board/Seat Cushion

No

Brands

DBI-SALA®

Buckle Material

Stainless Steel Grommet

Buckle Type

Tongue Buckle

Case Quantity

1

Connected Safety ID Equipped

Yes

D-ring Material

Zinc Plated Steel

D-ring Placement

Ba

3M™ DBI-SALA® Derrick Tongue Buckle Positioning Belt with Tongue Buckle Harness Connector 1003230, Yellow, Small

Part Number 1003230 3M Product Number 1003230 3M ID 7012815135

Details

Body belts available in designs to be used independently, as well as other versions to be used with 3M Fall Protection Harnesses

Multiple sizes available

Meets applicable regulatory standards

Typical properties

Belly Pad

Yes

Belt Type

Waist

Board/Seat Cushion

No

Brands

DBI-SALA®

Buckle Material

Stainless Steel Grommet

Buckle Type

Tongue Buckle

Case Quantity

1

Connected Safety ID Equipped

No

D-ring Material

Zinc Plated Steel

D-ring Placement

Do

3M™ DBI-SALA® Derrick Positioning Belt with Pass-Thru Suspension Strap Harness Connector 1000573, Yellow, Medium

Part Number 1000573 3M Product Number 1000573 3M ID 7012814992

Details

Body belts available in designs to be used independently, as well as other versions to be used with 3M Fall Protection Harnesses

Multiple sizes available

Meets applicable regulatory standards

Typical properties

Belly Pad

Yes

Belt Type

Waist

Board/Seat Cushion

No

Brands

DBI-SALA®

Buckle Material

Zinc Plated Steel

Buckle Type

None, Pass-through

Case Quantity

1

Connected Safety ID Equipped

No

D-ring Material

Zinc Plated Steel

D-ring Placement

Dou

3M™ DBI-SALA® Handline Keeper For Lineman Belt 9509844, Yellow

Part Number 9509844 3M Product Number 9509844 3M ID 7012821940

Details

Body belts available in designs to be used independently, as well as other versions to be used with 3M Fall Protection Harnesses
Multiple sizes available
Meets applicable regulatory standards

Typical properties

Brands
DBI-SALA®
Case Quantity
1
Connected Safety ID Equipped
No
Dimensions
(3.25x0.85x4.56)Unknown
For Use With
Lineman Belts
Product Color
Yellow
Product Type
Handline Keeper for Lineman Belt
Recommended Industry
Construction, General Ind

3M™ DBI-SALA® ExoFit NEX™ Tongue Buckle Belt 1000785, Gray, 4X

Part Number 1000785 3M Product Number 1000785 3M ID 7012815028

Details

Body belts available in designs to be used independently, as well as other versions to be used with 3M Fall Protection Harnesses
Multiple sizes available
Meets applicable regulatory standards

Typical properties

Belly Pad
No
Belt Type
Waist
Board/Seat Cushion
No
Brands
DBI-SALA®
Buckle Material
Stainless Steel Grommet
Buckle Type
Tongue Buckle
Case Quantity
1
Connected Safety ID Equipped
Yes
Hip Pad
No
Material
Polyester
Max Free Fall Allowed

3M™ DBI-SALA® Derrick Tongue Buckle Positioning Belt with Tongue Buckle Harness Connector 1003222, Yellow, X-Large

Part Number 1003222 3M Product Number 1003222 3M ID 7100241696

Details

Body belts available in designs to be used independently, as well as other versions to be used with 3M Fall Protection Harnesses

Multiple sizes available

Meets applicable regulatory standards

Typical properties

Belly Pad

Yes

Belt Type

Waist

Board/Seat Cushion

No

Brands

DBI-SALA®

Buckle Material

Stainless Steel Grommet

Buckle Type

Tongue Buckle

Case Quantity

1

Connected Safety ID Equipped

No

D-ring Material

Zinc Plated Steel

D-ring Placement

Do

3M™ DBI-SALA® Derrick Tongue Buckle Positioning Belt with Tongue Buckle Harness Connector 1003223, Yellow, 2X

Part Number 1003223 3M Product Number 1003223 3M ID 7012815133

Details

Body belts available in designs to be used independently, as well as other versions to be used with 3M Fall Protection Harnesses

Multiple sizes available

Meets applicable regulatory standards

Typical properties

Belly Pad

Yes

Belt Type

Waist

Board/Seat Cushion

No

Brands

DBI-SALA®

Buckle Material

Stainless Steel Grommet

Buckle Type

Tongue Buckle

Case Quantity

1

Connected Safety ID Equipped

No

D-ring Material

Zinc Plated Steel

D-ring Placement

Do

3M™ DBI-SALA® Derrick Tongue Buckle Positioning Belt with Pass-Thru Harness Connector 1000545, Yellow, X-Large

Part Number 1000545 3M Product Number 1000545 3M ID 7012693281

Details

Body belts available in designs to be used independently, as well as other versions to be used with 3M Fall Protection Harnesses

Multiple sizes available

Meets applicable regulatory standards

Typical properties

Belly Pad

Yes

Belt Type

Waist

Board/Seat Cushion

No

Brands

DBI-SALA®

Buckle Material

Stainless Steel Grommet and Zinc Plated Steel

Buckle Type

Tongue Buckle

Case Quantity

1

Connected Safety ID Equipped

No

D-ring Material

Zinc Plated Steel

3M™ DBI-SALA® Tongue Buckle Positioning Belt with Hip Pad 1000021, Yellow, X-Small

3M Product Number 1000021 3M ID 7012814936 UPC 00648250165348

Details

Body belts available in designs to be used independently, as well as other versions to be used with 3M Fall Protection Harnesses

Multiple sizes available

Meets applicable regulatory standards

Typical properties

Belly Pad

No

Belt Type

Waist

Board/Seat Cushion

No

Brands

DBI-SALA®

Buckle Material

Stainless Steel Grommet

Buckle Type

Tongue Buckle

Case Quantity

1

Connected Safety ID Equipped

Yes

D-ring Material

Zinc Plated Steel

D-ring Placement

Si

3M™ DBI-SALA® Tongue Buckle Restraint Belt with Hip Pad 1000008, Yellow, 4X

Part Number 1000008 3M Product Number 1000008 3M ID 7012814934

Details

Body belts available in designs to be used independently, as well as other versions to be used with 3M Fall Protection Harnesses

Multiple sizes available

Meets applicable regulatory standards

Typical properties

Belly Pad

No

Belt Type

Waist

Board/Seat Cushion

No

Brands

DBI-SALA®

Buckle Type

Tongue Buckle

Connected Safety ID Equipped

Yes

D-ring Placement

Back

Hip Pad

Yes

Material

Polyester/Nylon

Max Free Fall Allowed

Zero (no free fall permissib

3M™ DBI-SALA® Delta™ Tongue Buckle Belt 1000051, X-Small, 1 EA/Case

3M Product Number 1000051 3M ID 70007400073 UPC 00648250160275

Details

Body belts available in designs to be used independently, as well as other versions to be used with 3M Fall Protection Harnesses

Multiple sizes available

Meets applicable regulatory standards

Typical properties

Belly Pad

No

Belt Type

Waist

Board/Seat Cushion

No

Brands

DBI-SALA®

Buckle Material

Stainless Steel Grommet

Buckle Type

Tongue Buckle

Case Quantity

1

Connected Safety ID Equipped

Yes

Hip Pad

No

Material

Polyester/Nylon

Max Free Fall Al

3M™ DBI-SALA® Tongue Buckle Restraint Belt 1000161, Yellow, X-Small

3M Product Number 1000161 3M ID 7012814961 UPC 00648250165409

Details

Body belts available in designs to be used independently, as well as other versions to be used with 3M Fall Protection Harnesses

Multiple sizes available

Meets applicable regulatory standards

Typical properties

Belly Pad

No

Belt Type

Waist

Board/Seat Cushion

No

Brands

DBI-SALA®

Buckle Material

Stainless Steel Grommet

Buckle Type

Tongue Buckle

Case Quantity

1

Connected Safety ID Equipped

Yes

D-ring Material

Zinc Plated Steel

D-ring Placement

FI

3M™ DBI-SALA® Tongue Buckle Restraint Belt with Hip Pad 1000007, Yellow, 3X

Part Number 1000007 3M Product Number 1000007 3M ID 7012814933

Details

Body belts available in designs to be used independently, as well as other versions to be used with 3M Fall Protection Harnesses

Multiple sizes available

Meets applicable regulatory standards

Typical properties

Belly Pad

No

Belt Type

Waist

Board/Seat Cushion

No

Brands

DBI-SALA®

Buckle Material

Stainless Steel Grommet

Buckle Type

Tongue Buckle

Case Quantity

1

Connected Safety ID Equipped

Yes

D-ring Material

Zinc Plated Steel

D-ring Placement

Ba

3M™ DBI-SALA® Tongue Buckle Positioning Belt with Hip Pad 1000028, Yellow, 4X

Part Number 1000028 3M Product Number 1000028 3M ID 7012814949

Details

Body belts available in designs to be used independently, as well as other versions to be used with 3M Fall Protection Harnesses

Multiple sizes available

Meets applicable regulatory standards

Typical properties

Belly Pad

No

Belt Type

Waist

Board/Seat Cushion

No

Brands

DBI-SALA®

Buckle Material

Stainless Steel Grommet

Buckle Type

Tongue Buckle

Case Quantity

1

Connected Safety ID Equipped

Yes

D-ring Material

Zinc Plated Steel

D-ring Placement

Si

3M™ DBI-SALA® Derrick Tongue Buckle Positioning Belt with Pass-Thru Harness Connector 1000544, Yellow, Large

Part Number 1000544 3M Product Number 1000544 3M ID 7012814984

Details

Body belts available in designs to be used independently, as well as other versions to be used with 3M Fall Protection Harnesses

Multiple sizes available

Meets applicable regulatory standards

Typical properties

Belly Pad

Yes

Belt Type

Waist

Board/Seat Cushion

No

Brands

DBI-SALA®

Buckle Material

Stainless Steel Grommet and Zinc Plated Steel

Buckle Type

Tongue Buckle

Case Quantity

1

Connected Safety ID Equipped

No

D-ring Material

Zinc Plated Steel

3M™ DBI-SALA® Tongue Buckle Restraint Belt 1000614, Yellow, Medium

3M Product Number 1000614 3M ID 7012815000 UPC 00648250165546

Details

Body belts available in designs to be used independently, as well as other versions to be used with 3M Fall Protection Harnesses

Multiple sizes available

Meets applicable regulatory standards

Typical properties

Belly Pad

No

Belt Type

Waist

Board/Seat Cushion

No

Brands

DBI-SALA®

Buckle Material

Stainless Steel Grommet

Buckle Type

Tongue Buckle

Case Quantity

1

Connected Safety ID Equipped

Yes

D-ring Material

Zinc Plated Steel

D-ring Placement

Ba

3M™ DBI-SALA® Tongue Buckle Positioning Belt with Hip Pad 1000022, Yellow, Small

3M Product Number 1000022 3M ID 7012814938 UPC 00648250166673

Details

Body belts available in designs to be used independently, as well as other versions to be used with 3M Fall Protection Harnesses

Multiple sizes available

Meets applicable regulatory standards

Typical properties

Belly Pad

No

Belt Type

Waist

Board/Seat Cushion

No

Brands

DBI-SALA®

Buckle Material

Stainless Steel Grommet

Buckle Type

Tongue Buckle

Case Quantity

1

Connected Safety ID Equipped

Yes

D-ring Material

Zinc Plated Steel

D-ring Placement

Si

3M™ DBI-SALA® Tongue Buckle Restraint Belt 1000163, Yellow, Medium

3M Product Number 1000163 3M ID 7012814965 UPC 00648250165416

Details

Body belts available in designs to be used independently, as well as other versions to be used with 3M Fall Protection Harnesses

Multiple sizes available

Meets applicable regulatory standards

Typical properties

Belly Pad

No

Belt Type

Waist

Board/Seat Cushion

No

Brands

DBI-SALA®

Buckle Material

Stainless Steel Grommet

Buckle Type

Tongue Buckle

Case Quantity

1

Connected Safety ID Equipped

Yes

D-ring Material

Zinc Plated Steel

D-ring Placement

FI

3M™ DBI-SALA® Tongue Buckle Positioning Belt with Hip Pad 1000025, Yellow, X-Large

3M Product Number 1000025 3M ID 7012814944 UPC 00840779004393

Details

Body belts available in designs to be used independently, as well as other versions to be used with 3M Fall Protection Harnesses

Multiple sizes available

Meets applicable regulatory standards

Typical properties

Belly Pad

No

Belt Type

Waist

Board/Seat Cushion

No

Brands

DBI-SALA®

Buckle Material

Stainless Steel Grommet

Buckle Type

Tongue Buckle

Case Quantity

1

Connected Safety ID Equipped

Yes

D-ring Material

Zinc Plated Steel

D-ring Placement

Si

3M™ DBI-SALA® ExoFit NEX™ Tongue Buckle Belt 1000781, Gray, Large

Part Number 1000781 3M Product Number 1000781 3M ID 7012815024

Details

Body belts available in designs to be used independently, as well as other versions to be used with 3M Fall Protection Harnesses

Multiple sizes available

Meets applicable regulatory standards

Typical properties

Belly Pad

No

Belt Type

Waist

Board/Seat Cushion

No

Brands

DBI-SALA®

Buckle Material

Stainless Steel Grommet

Buckle Type

Tongue Buckle

Case Quantity

1

Connected Safety ID Equipped

Yes

Hip Pad

No

Material

Polyester

Max Free Fall Allowed

3M™ DBI-SALA® Tongue Buckle Restraint Belt 1000162, Yellow, Small

3M Product Number 1000162 3M ID 7012814963 UPC 00840779007523

Details

Body belts available in designs to be used independently, as well as other versions to be used with 3M Fall Protection Harnesses

Multiple sizes available

Meets applicable regulatory standards

Typical properties

Belly Pad

No

Belt Type

Waist

Board/Seat Cushion

No

Brands

DBI-SALA®

Buckle Material

Stainless Steel Grommet

Buckle Type

Tongue Buckle

Case Quantity

1

Connected Safety ID Equipped

Yes

D-ring Material

Zinc Plated Steel

D-ring Placement

FI

3M™ DBI-SALA® Tongue Buckle Restraint Belt 1000618, Yellow, 3X

Part Number 1000618 3M Product Number 1000618 3M ID 7012815006

Details

Body belts available in designs to be used independently, as well as other versions to be used with 3M Fall Protection Harnesses
Multiple sizes available
Meets applicable regulatory standards

Typical properties

Belly Pad
No
Belt Type
Waist
Board/Seat Cushion
No
Brands
DBI-SALA®
Buckle Material
Stainless Steel Grommet
Buckle Type
Tongue Buckle
Case Quantity
1
Connected Safety ID Equipped
Yes
D-ring Material
Zinc Plated Steel
D-ring Placement
Ba

3M™ DBI-SALA® Tongue Buckle Belt 1000058, Yellow, 4X

Part Number 1000058 3M Product Number 1000058 3M ID 7012814956

Details

Body belts available in designs to be used independently, as well as other versions to be used with 3M Fall Protection Harnesses
Multiple sizes available
Meets applicable regulatory standards

Typical properties

Belly Pad
No
Belt Type
Waist
Board/Seat Cushion
No
Brands
DBI-SALA®
Buckle Material
Stainless Steel Grommet
Buckle Type
Tongue Buckle
Case Quantity
1
Connected Safety ID Equipped
Yes
Hip Pad
No
Material
Polyester/Nylon
Max Free Fall Al

3M™ DBI-SALA® Tongue Buckle Restraint Belt 1000612, Yellow, X-Small

3M Product Number 1000612 3M ID 7012814996 UPC 00648250165522

Details

Body belts available in designs to be used independently, as well as other versions to be used with 3M Fall Protection Harnesses

Multiple sizes available

Meets applicable regulatory standards

Typical properties

Belly Pad

No

Belt Type

Waist

Board/Seat Cushion

No

Brands

DBI-SALA®

Buckle Material

Stainless Steel Grommet

Buckle Type

Tongue Buckle

Case Quantity

1

Connected Safety ID Equipped

Yes

D-ring Material

Zinc Plated Steel

D-ring Placement

Ba

3M™ DBI-SALA® ExoFit NEX™ Tongue Buckle Belt 1000784, Gray, 3X

Part Number 1000784 3M Product Number 1000784 3M ID 7012815027

Details

Body belts available in designs to be used independently, as well as other versions to be used with 3M Fall Protection Harnesses
Multiple sizes available
Meets applicable regulatory standards

Typical properties

Belly Pad
No
Belt Type
Waist
Board/Seat Cushion
No
Brands
DBI-SALA®
Buckle Material
Stainless Steel Grommet
Buckle Type
Tongue Buckle
Case Quantity
1
Connected Safety ID Equipped
Yes
Hip Pad
No
Material
Polyester
Max Free Fall Allowed

3M™ DBI-SALA® Tongue Buckle Restraint Belt with Hip Pad 1000006, Yellow, 2X

Part Number 1000006 3M Product Number 1000006 3M ID 7012814931

Details

Body belts available in designs to be used independently, as well as other versions to be used with 3M Fall Protection Harnesses

Multiple sizes available

Meets applicable regulatory standards

Typical properties

Belly Pad

No

Belt Type

Waist

Board/Seat Cushion

No

Brands

DBI-SALA®

Buckle Material

Stainless Steel Grommet

Buckle Type

Tongue Buckle

Case Quantity

1

Connected Safety ID Equipped

Yes

D-ring Material

Zinc Plated Steel

D-ring Placement

Ba

3M™ DBI-SALA® ExoFit™ Tongue Buckle Belt 1000717, Gray, X-Large

Part Number 1000717 3M Product Number 1000717 3M ID 7012815013

Details

Body belts available in designs to be used independently, as well as other versions to be used with 3M Fall Protection Harnesses

Multiple sizes available

Meets applicable regulatory standards

Typical properties

Belly Pad

No

Belt Type

Waist

Board/Seat Cushion

No

Brands

DBI-SALA®

Buckle Material

Stainless Steel Grommet

Buckle Type

Tongue Buckle

Case Quantity

1

Connected Safety ID Equipped

Yes

Hip Pad

No

Material

Polyester

Max Free Fall Allowed

3M™ DBI-SALA® ExoFit™ NEX Tongue Buckle Belt 1000778, Gray, X-Small

Part Number 1000778 3M Product Number 1000778 3M ID 7012815021

Details

Body belts available in designs to be used independently, as well as other versions to be used with 3M Fall Protection Harnesses

Multiple sizes available

Meets applicable regulatory standards

Typical properties

Belly Pad

No

Belt Type

Waist

Board/Seat Cushion

No

Brands

DBI-SALA®

Buckle Material

Stainless Steel Grommet

Buckle Type

Tongue Buckle

Case Quantity

1

Connected Safety ID Equipped

Yes

Hip Pad

No

Material

Polyester

Max Free Fall Allowed

3M™ DBI-SALA® Tongue Buckle Restraint Belt 1000613, Yellow, Small

3M Product Number 1000613 3M ID 7012814998 UPC 00648250165539

Details

Body belts available in designs to be used independently, as well as other versions to be used with 3M Fall Protection Harnesses

Multiple sizes available

Meets applicable regulatory standards

Typical properties

Belly Pad

No

Belt Type

Waist

Board/Seat Cushion

No

Brands

DBI-SALA®

Buckle Material

Stainless Steel Grommet

Buckle Type

Tongue Buckle

Case Quantity

1

Connected Safety ID Equipped

Yes

D-ring Material

Zinc Plated Steel

D-ring Placement

Ba

3M™ DBI-SALA® Tongue Buckle Belt 1000052, Yellow, Small

Part Number 1000052 3M Product Number 1000052 3M ID 7012814950

Details

Body belts available in designs to be used independently, as well as other versions to be used with 3M Fall Protection Harnesses
Multiple sizes available
Meets applicable regulatory standards

Typical properties

Belly Pad
No
Belt Type
Waist
Board/Seat Cushion
No
Brands
DBI-SALA®
Buckle Material
Stainless Steel Grommet
Buckle Type
Tongue Buckle
Case Quantity
1
Connected Safety ID Equipped
Yes
Hip Pad
No
Material
Polyester/Nylon
Max Free Fall Al

3M™ DBI-SALA® Derrick Tongue Buckle Positioning Belt with Pass-Thru Harness Connector 1000543, Yellow, Medium

Part Number 1000543 3M Product Number 1000543 3M ID 7012814983

Details

Body belts available in designs to be used independently, as well as other versions to be used with 3M Fall Protection Harnesses

Multiple sizes available

Meets applicable regulatory standards

Typical properties

Belly Pad

Yes

Belt Type

Waist

Board/Seat Cushion

No

Brands

DBI-SALA®

Buckle Material

Stainless Steel Grommet and Zinc Plated Steel

Buckle Type

Tongue Buckle

Case Quantity

1

Connected Safety ID Equipped

No

D-ring Material

Zinc Plated Steel

3M™ DBI-SALA® Tongue Buckle Restraint Belt 1000166, Yellow, 2X

Part Number 1000166 3M Product Number 1000166 3M ID 7012814971

Details

Body belts available in designs to be used independently, as well as other versions to be used with 3M Fall Protection Harnesses
Multiple sizes available
Meets applicable regulatory standards

Typical properties

Belly Pad
No
Belt Type
Waist
Board/Seat Cushion
No
Brands
DBI-SALA®
Buckle Material
Stainless Steel Grommet
Buckle Type
Tongue Buckle
Case Quantity
1
Connected Safety ID Equipped
Yes
D-ring Material
Zinc Plated Steel
D-ring Placement
FI

3M™ DBI-SALA® Tongue Buckle Restraint Belt 1000623, Yellow, 5X

Part Number 1000623 3M Product Number 1000623 3M ID 7012815007

Details

Body belts available in designs to be used independently, as well as other versions to be used with 3M Fall Protection Harnesses
Multiple sizes available
Meets applicable regulatory standards

Typical properties

Belly Pad
No
Belt Type
Waist
Board/Seat Cushion
No
Brands
DBI-SALA®
Buckle Material
Stainless Steel Grommet
Buckle Type
Tongue Buckle
Case Quantity
1
Connected Safety ID Equipped
Yes
D-ring Material
Zinc Plated Steel
D-ring Placement
Ba

3M™ DBI-SALA® Tongue Buckle Restraint Belt 1000616, Yellow, X-Large

3M Product Number 1000616 3M ID 7012815004 UPC 00648250165553

Details

Body belts available in designs to be used independently, as well as other versions to be used with 3M Fall Protection Harnesses

Multiple sizes available

Meets applicable regulatory standards

Typical properties

Belly Pad

No

Belt Type

Waist

Board/Seat Cushion

No

Brands

DBI-SALA®

Buckle Material

Stainless Steel Grommet

Buckle Type

Tongue Buckle

Case Quantity

1

Connected Safety ID Equipped

Yes

D-ring Material

Zinc Plated Steel

D-ring Placement

Ba

3M™ Scotchlite™ Reflective Material 8987NFPA Series

Details

3M™ Scotchlite™ Reflective Material is designed for enhancing visibility in low light and nighttime conditions
Certified to various flame resistant standards such as NFPA
Fluorescent properties help to make material highly visible in daylight, dawn and dusk

Typical properties

Adhesive
None
Attachment Type
Sew On
Backing
None
Backing Material
Flame Retardant Cotton
Brands
Scotchlite™
Certified Performance Required
NFPA
Daytime Color
Fluorescent Lime-Yellow
Flame Resistant
Yes
Home Wash Cycles 60°C (140°F) at ANS

Dimensions and Classifications

Overall Length (Imperial)
54.68 yd, 109.36 yd, 218.72 yd
Overall Length (Metric)
50 m, 100 m, 200 m
Overall Width (Imperial)
2 in, 3 in, 36 in, 36.25 in
Overall Width (Metric)
50.8 mm, 76.2 mm, 914.4 mm, 920.75 mm

3M™ Protective Coverall 4510

Details

Constructed from microporous PE laminate material for Type 5 and Type 6 protection

Does not contain silicone or natural rubber latex components

Two-way zipper with sealable storm flap helps provide additional protection against contaminants

Anti-static treatment can help reduce static build-up

Recommended for use in multiple industries including commercial buildings, design and construction, facility sanitation, food safety, and more

Available in collared and hooded profiles

Available in a wide range of sizes

20 or 25 units are included in each case

Typical properties

Additional Protection Features

Antistatic Protection, Radioactive Particulate Protection

Closure Method

Two-way Zipper

Coverall Style

Collared, Hooded

Features

2 Panel Hood, Anti-static, Collar (No Hood), Elastic Cuff, Elastic Waist, Elastic Waist

3M™ E-A-Rflex™ 28 Banded Hearing Protector 320-1000, 100 EA/Case

3M Product Number 320-1000 3M ID 7000127170 UPC 10080529200065

Details

Pivoting tips for proper, comfortable fit that moves with the wearer for more consistent protection

Replacement Pod Product Code 320-1001

Noise Reduction Rating (NRR)* 28 dB. CSA Class AL

*The NRR may overestimate the hearing protection provided during typical use

Typical properties

Banded

Yes

Brands

E-A-R™

Case Quantity

100

Corded

Yes

Dielectric

No

Earplug Material

Foam/Thermoplastic

Earplug Shape

Cone

Earplug Size

Regular

Electrically Insulated

Yes

Hearing Protection Style

Banded

Insertion Style

No Roll

Materi

3M™ PELTOR™ LiteCom Plus Headsets

Details

Protective communication solution for hands-free, clear communication in noisy environments

Features an integrated analog two-way radio and noise-canceling speech microphone

Utilizes both Push-to-Talk and voice-operated transmission (VOX)

Helps provide hearing protection when exposed to hazardous noise

Integrated two-way radio with 22 pre-programmed FRS channels

Environmental listening technology helps provide protection when it's loud, as well as helps workers hear environmental sounds when it's not

Typical properties

Attenuation Rating

25 dB,27 dB

Audio Type

Communication

Battery Life

20 hr

Battery Type

Lithium-ion Rechargeable

Case Quantity

5

Communication Type

2-Way

Connection Type

Integrated Communication

Hearing Protection Style

Earmuffs

Product Co

3M™ Disposable Overboot Covers 450, Universal Size, 100 pairs/Case

3M Product Number 450 3M ID 7000088638 UPC 04046719121076

Details

PVC sole can help reduce slipping

Universal size with PVC ties help provide a good fit for a wide range of workers

Constructed from microporous PE laminate material

Elastic at the calf provides closure around the top of the footwear for protection against contaminants

Recommended for use in multiple industries including asbestos abatement and inspection, agriculture, cleaning, maintenance, non-hazardous operations, painting, pharmaceutical cleanroom, metalwork, and more

100 pairs included in each case

Typical properties

Brands

3M™

Features

Anti-static, Non-skid Sole, Ties for Secure Fit

Hazard Type

Non Hazardous liquids & dust (CE simple)

Material

Laminate

Product Color

White

Product Type

Overboot

Recommended Application

Catering, Clean Rooms, Electronics Ma

3M™ PELTOR™ Tactical Earplug TEP-300 GE, Grey

3M Product Number TEP-300 GE 3M ID 7100227633 UPC 00638060429860

Details

Wireless - Utilizing near field magnetic induction, 3M™ PELTOR™ Tactical Earplugs, TEP-300 can be wirelessly connected to the 3M™ PELTOR™ System Control Unit, SCU-300 (not included)

Compact Hearing Protection - Comes with multiple sizes and types of replaceable eartips, designed to help provide hearing protection

Situational Awareness - 3M™ PELTOR™ Tactical Earplugs, features environmental listening function – a capability designed to help provide auditory situational awareness, while still helping provide protection from hazardous noise

In Ear Speech Microphone - The TEP-300 features in-ear, acoustical, speech communications microphones which pick up sound waves from your voice as you speak

Portable Charging Case - Up to 16 recharging cycles with AA or AAA batteries

Micro USB-C Charging Port - USB port enables the charging of the earplugs when plugged into a computer or wall socket (cable not included)

3M strongly recommends individual fit testing of hearing protectors. If the NRR is used to estimate typical workplace protection, 3M recommends that the noise reduction value be reduced by 50% or in accordance with applicable regulations

Typical properties

Attenuation Rating

30 dB,23 dB

Battery Life

Approx. 10 hours

Battery Type

Lithium-ion Rechargeable

Brands

PELTOR™

Case Quantity

20 Kit / Case

Communication Type

Ambient Listening

Hearing Protection Style

In-Ear

Product Color

Gray

Product S

3M™ PELTOR™ Tactical Earplug, TEP-200

3M Product Number TEP-200 3M ID 7010386290 UPC 00093045938247

Details

Allow audio signals to be received wirelessly from a neckloop accessory

Helps provide hearing protection

Environmental Microphones for Level-dependent hearing protection and situational awareness

The ear pieces are rechargeable via Micro USB or 3-AA Alkaline Batteries

Typical properties

Auxiliary Port

Micro USB Charging Port

Battery Type

Lithium-Ion

Bluetooth

No

Brands

PELTOR™

Built In FM and or AM Radio

No

Built in 2-Way Radio

No

Communication Type

Environmental Listening, Listen Only, Two-way Radio

Communication via Exter

3M™ PELTOR™ Tactical Earplug TEP-300 CY, Coyote Brown

3M Product Number TEP-300 CY 3M ID 7100227650 UPC 00638060429822

Details

Wireless - Utilizing near field magnetic induction, 3M™ PELTOR™ Tactical Earplugs, TEP-300 can be wirelessly connected to the 3M™ PELTOR™ System Control Unit, SCU-300 (not included)

Compact Hearing Protection - Comes with multiple sizes and types of replaceable eartips, designed to help provide hearing protection

Situational Awareness - 3M™ PELTOR™ Tactical Earplugs, features environmental listening function – a capability designed to help provide auditory situational awareness, while still helping provide protection from hazardous noise

In Ear Speech Microphone - The TEP-300 features in-ear, acoustical, speech communications microphones which pick up sound waves from your voice as you speak

Portable Charging Case - Up to 16 recharging cycles with AA or AAA batteries

Micro USB-C Charging Port - USB port enables the charging of the earplugs when plugged into a computer or wall socket (cable not included)

3M strongly recommends individual fit testing of hearing protectors. If the NRR is used to estimate typical workplace protection, 3M recommends that the noise reduction value be reduced by 50% or in accordance with applicable regulations

Typical properties

Attenuation Rating

30 dB, 23 dB

Battery Life

Approx. 10 hours

Battery Type

Lithium-ion Rechargeable

Brands

PELTOR™

Case Quantity

20 Kit / Case

Communication Type

Ambient Listening

Hearing Protection Style

In-Ear

Product Color

Coyote Brown

P

3M™ PELTOR™ Tactical Earplug TEP-100, 1 Kit EA/Case

Part Number 66525 3M Product Number TEP-100 3M ID 7100066023

Details

Rechargeable electronic earplugs help reduce loud noise while amplifying low-level sounds

Intuitive one-button operation turns unit on and off and selects high or normal volume setting

Lithium-Ion battery provides up to 16 hours of continuous operation between charges

Portable charging case powered by 3 AA alkaline batteries or USB (Micro B) port

Choice of replaceable communications eartips designed to fit most ear canal sizes: UltraFit™ Communication Tip (23dB), Triple C Communication Tip (27dB), and Skull Screw Communication Tip (30dB)

Tactical earplugs and portable charging station (with cover and USB ports closed) are IP67 compliant and water resistant (immersion of up to 1 meter for 30 minutes)

Innovative microphone port design helps protect eartips against water ingress

Portable charging station helps protect earplugs in wet and austere environments

Compatible with most headborne Personal Protective Equipment such as helmets, hardhats, eyewear and faceshields

Optional earplug cord can be attached to earplug for additional security

Typical properties

Auxiliary Port

Micro USB Charging Port

Battery Type

Lithium-Ion

Brands

PELTOR™

Communication Type

Environmental Listening

Hearing Protection Style

Earplugs

Hearing Protection Type

Disposable Foam Earplugs, Reusable Earplugs

Product Color

Blac

3M™ E-A-R™ TaperFit™ 2 Earplugs

Details

Tapered shape is designed to help fit the ear canal

Features a Noise reduction rating (NRR)*: 32 dB for large size or in combination with regular size; 28 dB for regular size alone

Soft foam helps conform to the shape of the ear canal for a comfortable, snug fit

Corded and uncorded options available

Available in regular and large sizes

Compatible with the 3M™ E-A-Rfit™ Validation System

CSA Class AL

*U.S. EPA specifies the NRR as the measure of hearing protector noise reduction. However, 3M makes no warranties as to the suitability of the NRR for this purpose. 3M strongly recommends personal fit testing of hearing protectors. Research suggests that users may receive less noise reduction than indicated by the attenuation label value(s) on the packaging due to variation in fit, fitting skill, and motivation of the user. Refer to applicable regulations or guidance on how to adjust attenuation label values. It is recommended that the NRR be reduced by 50% to better estimate typical protection

Typical properties

Attenuation Rating

32.0 Decibel

Banded

No

Case Quantity

2000 Pair

Cord Color

Blue

Cord Material

Vinyl

Cord Type

None, Vinyl

Corded

No, Yes

Dielectric

No

Dispenser Available

No

Earplug Color

Yellow

Earplug Material

Foam

Earplug Shape

3M™ DBI-SALA® Confined Space Lower Mast Extension for Upper Offset Davit Mast

Details

Lower davit mast extension

Fits 3M™ DBI-SALA® Offset Davit Masts

Depending on davit base, can be combined with one or two lower mast extensions to increase overall height

Durable construction

Recommended for use in many industries

Available in lengths of 21 in. (53.3 cm), 33 in. (83.8 cm), 45 in. (114.3 cm), and 57 in. (144.8 cm)

Typical properties

Case Quantity

1

Connected Safety ID Equipped

No

For Use With

Upper Offset Davit Mast

Install Type

Portable

Net Weight (Imperial)

14.1 lb, 17.6 lb, 19.7 lb, 24.1 lb

Net Weight (Metric)

6.4 kg, 8 kg, 9 kg, 11 kg

Product Color

Green, Silver

Pro

Dimensions and Classifications

Overall Height (Imperial)

26.94 in, 39 in, 51.99 in, 63.99 in

Overall Height (Metric)

68.43 cm, 99.06 cm, 132.05 cm, 162.53 cm

Overall Length (Imperial)

21 in, 33 in, 45 in, 57 in

3M™ Flat Temple Safety Eyewear, Black/Red, Gray Lens

3M ID 70006983046 UPC 00051141975887

Details

Durable, one-piece lens helps provide limited protection from light to moderate impact hazards

Lightweight, durable design for comfort and lasting wear

Sleek temples create a comfortable fit when worn with ear protection

When worn with hearing protection, flat temple design limits risk of reduced effectiveness

Flexible nose and ear pieces provide comfort

Scratch-resistant coating helps keep vision clear

Impact-resistant lens blocks 99.9% of UV rays

Great for use indoors and outdoors

Meets the requirements of ANSI Z87.1, CSA Z94.3 and AS/NZS 1337

Gray lens helps reduce sunlight and is popular for outdoor use

Typical properties

Brands

3M™

Catalog Number

47011H1-DC

Factory ISO Certification

No ISO Certification information available

Frame Material

Polycarbonate

Frame Style

Wraparound

Hard Coat Lens

No

Material

Polycarbonate

Sealed Eyewear

No

Splash Protection

No

Dimensions and Classifications

Overall Height (Imperial)

10 in

Overall Height (Metric)

254 mm

Overall Length (Imperial)

4 in

Overall Length (Metric)

101.6 mm

Overall Width (Imperial)

2.5 in
Overall Width (Metric)
63.5 mm

3M™ Protecta® Self-Retracting Lifeline

Details

- Swiveling anchorage connector loop and carabiner
- Aluminum or thermoplastic housing design
- Self-locking snap hook on lifeline
- Compact, lightweight design
- Cable lengths of 20 ft (6 m) or greater feature stackable housing design
- Quick activating speed-sensing locking system
- Features impact-indicating external energy absorber (for models with external shock pack)
- Corrosion resistant components
- Available in multiple configurations, lifeline lengths, and material types
- Emergency retrieval system available on some models
- Reliable fall arrest energy dissipation system

Typical properties

- ANSI Class Level
- Class 1, Class 2
- Anchor Connection Type
- Carabiner
- Anchor Hook Material
- Zinc Plated Steel
- Anchor Hook Material
- Zinc Plated Steel
- Brands
- PROTECTA®
- Connected Safety ID Equipped
- No
- Harness Connection Hook Material
- Zinc Plated Ste

Dimensions and Classifications

- Overall Length (Imperial)
- 6 ft, 11 ft, 20 ft, 33 ft, 50 ft, 66 ft
- Overall Length (Metric)
- 1.83 m, 3.35 m, 6.09 m, 6.1 m, 10.1 m, 15.2 m, 20.1 m

3M™ Connected Safety ID Mechanical Mount HF RFID Tag CSID-MMTY, 9505839, Yellow, 25/Pack, 1 ea/Case

3M Product Number RFID-MMTY 3M ID 7010386287 UPC 00051131274204

Details

Durable, heavy-duty construction
Designed to be mechanically mounted to various surfaces
Utilizes passive high frequency 13.56 MHz technology with unique ID code programmed and printed on each tag
Ready for use with 3M™ Safety & Inspection Manager

Typical properties

Brands
3M™
Dimensions
2.30x1.50x0.40 (in)
Material
Nylon
Operating Frequency
13.56 MHz (HF)
Operating Temperature
-35°C to 85°C / -31°F to 185°F
Product Color
Yellow
Product Type
RFID Tags
Recommended Application
Safety Program Management

3M™ Connected Safety ID Mechanical Mount HF RFID Tag CSID-HANG, 9505842, Yellow, 25/Pack, 1 ea/Case

3M Product Number RFID-HANG 3M ID 7010386370 UPC 00051131274211

Details

Durable, heavy-duty construction
Designed to be mounted to with cable ties (included)
Utilizes passive high frequency 13.56 MHz technology with unique ID code programmed and printed on each tag
Ready for use with 3M™ Safety & Inspection Manager

Typical properties

Brands
3M™
Dimensions
1.38x1.15x0.19 (in)
Material
Nylon
Operating Frequency
13.56 MHz (HF)
Operating Temperature
-35°C to 85°C / -31°F to 185°F
Product Color
Yellow
Product Type
RFID Tags
Recommended Application
Safety Program Management

3M™ PELTOR™ ComTac™ V Headsets

Details

Helps protect from hazardous steady-state and impulse noise
Clear 2-way audio comms — radios & intercoms
Environmental listening for auditory situational awareness
“Talk-through” for face-to-face verbal conversation
Features omni-directional microphones and high-fidelity speakers
Accessory rail connection (ARC) option
Engineered to prevent cross-talk with dual comms

Typical properties

Attenuation Rating
23 dB, 20 dB, 22 dB
Audio Type
Communication
Battery Life
150 Hours, Approx. 200 hours
Bluetooth
No
Case Quantity
1, 10
Communication Direction
Listen-only, Two-way
Communication Type
Tactical
Communication via External 2-Way

3M™ DBI-SALA® Drop-Thru Anchor

Details

Available in 2, 6, 8.5, and 10 ft. lengths
Installs into 1-1/2 in. to 1-3/4 in. dia. hole (38.1 to 44.5 mm) In Concrete, minimum thickness of 4 in. (101.6 mm)
Use on overhead concrete or steel applications
Fall arrest- and restraint-rated for one worker for jobsite versatility
Features high-strength stainless steel construction
Partially shielded cable for added protection
Compatible with various fall arrest systems
Compact, lightweight design
Meets the requirements for OSHA 1910.140 and OSHA 1926.502
Recommended for use in multiple industries including general industrial, mining, and oil and gas

Typical properties

Anchor Install Type
Reusable
Attachment Type
Drop-thru
Case Quantity
1
Connected Safety ID Equipped
No
D-ring Material
Zinc Plated Steel
Install Type
Reusable
Material
Steel, Zinc Plated Steel
Product Color
Silver
Product Type
Drop-thru A

Dimensions and Classifications

Overall Length (Imperial)
2 ft, 6 ft, 10 ft

3M™ DBI-SALA® Rollgliss™ Rope Over Wire Automatic Descent

3M ID B00033554

Details

Descent control emergency device with body sling, anchoring carabiner, cable spool, and carrying bag

Fully automatic controlled descent from a wide range of elevated work areas

Bi-directional design saves time during rescue operations

Galvanized-steel wire core polyester rope lifeline available in lengths of 50 ft. (15.2 m) to 400 ft. (121.9 m)

Pre-rigged system requires no tools or special training

Compact, lightweight design built with corrosion-resistant materials

Recommended for use in construction, oil and gas, mining, transportation, utilities, wind energy, and general industrial applications

Other lengths available up to 1,000 ft. (305 m) height

3M™ Hard Hat 70 Lumen Task Light, HL100, 10 EA/Case

3M Product Number HL100 3M ID 7010386281 UPC 50051131275664

Details

Lightweight

70 Lumens

IPX-4 Water resistant

4 modes

LED

Comes with 3M™ Dual Lock fasteners eliminating the need for a headband that could interfere with earmuffs and other attachments

Comes with a rubber headband which provides a secure attachment to most 3M hard hats

Comes with nylon headband which allows the lamp to be worn by the user without wearing a hard hat

Versatile headlamp that allows hands free lighting for any industrial worker

Comes with 3 AAA batteries

Typical properties

Brands

3M™

Case Quantity

10

Compatible Hard Hat

H-700, H-800, X5000

For Use With

Hard Hats

Product Color

Black

Product Type

Task Light

Recommended Application

Assembly, Electrical, Facility Maintenance, Grinding, Machine Operation, Painting,

3M™ Hard Hat 150 Lumen, Intrinsically Safe Task Light, HL300IS, 10 EA/Case

3M Product Number HL300IS 3M ID 7010386282 UPC 50051131275688

Details

Intrinsically Safe

150 Lumens

IPX-7 Water resistant

5 modes

Spot light and flood light

Comes with 3M™ Dual Lock fasteners eliminating the need for a headband that could interfere with earmuffs and other attachments

Comes with a rubber headband which provides a secure attachment to most 3M hard hats

Comes with nylon headband which allows the lamp to be worn by the user without wearing a hard hat

Versatile headlamp that allows hands free lighting for any industrial worker that needs intrinsically safe certification

Comes with 3 AAA batteries

Typical properties

Brands

3M™

Case Quantity

10

Compatible Hard Hat

H-700, H-800, X5000

For Use With

Hard Hats

Product Color

Black

Product Type

Task Light

Recommended Application

Assembly, Electrical, Facility Maintenance, Grinding, Machine Operation, Painting,

3M™ Hard Hat 150 Lumen Task Light, HL200, 10 EA/Case

3M Product Number HL200 3M ID 7010316628 UPC 50051131275671

Details

Lightweight

150 Lumens

IPX-4 Water resistant

4 modes

Spot light and flood light

Comes with 3M™ Dual Lock fasteners eliminating the need for a headband that could interfere with earmuffs and other attachments

Comes with a rubber headband which provides a secure attachment to most 3M hard hats

Comes with nylon headband which allows the lamp to be worn by the user without wearing a hard hat

Versatile headlamp that allows hands free lighting for any industrial worker that needs spot and flood light options

Comes with 3 AAA batteries

Typical properties

Brands

3M™

Case Quantity

10

Compatible Hard Hat

H-700, H-800, X5000

For Use With

Hard Hats

Product Color

Brown

Product Type

Task Light

Recommended Application

Assembly, Electrical, Facility Maintenance, Grinding, Machine Operation, Painting,

3M™ W-Series Supplied Air Regulator Valves & Assemblies

Details

Low maintenance - no filters, cartridges, or batteries to maintain

Typical properties

CFM Capacity per Minute

100 CFM, 50 CFM

Case Quantity

1/case, 1/pack

Compatible With

3M™ Versaflo™ Air Regulating Valve, 3M™ W-2806 Filtration Panel

Fitting Type

Industrial Interchange

Intrinsically Safe

No

Pressure Type

High

Product Color

Bla

3M™ Adflo™ Powered Air Purifying Respirator System with 3M™ Speedglas™ 9100 MP Welding Helmet

Details

3M™ Speedglas™ 9100 MP Welding Helmet with 3M™ Adflo™ Powered Air Purifying Respirator System
Wide, clear visor plate
Sold with options of 3M™ Speedglas™ 9100 Welding Filters
Ergonomic, adjustable headband for good comfort, helmet stability, and weight distribution
Recommended for construction, design & construction, heavy infrastructure, and industrial maintenance industries

Typical properties

ADF Dark State Shades
None, Variable 5, 8-13
ADF Model
9100XXi, None
ADF Shade Range
None, Variable 5, 8-13
ADF Viewing Area (Metric)
73 mm x 107 mm
ADF Viewing Area (hwx)
2.8x4.2in
Air Source
PAPR
Assigned Protection Factor
25
Battery Life

3M™ DBI-SALA® FlexiGuard™ M100 Permanent Mount Base

Details

- Powder coated steel upright and gusset components
- Extended rail-length increases safe working area compared to our previous jib systems
- Extended anchor height enhances capabilities in various applications compared to our previous jib systems
- Automatic mast lock helps prevent uncontrolled mast movement
- Aluminum extruded trolley rail with stainless steel / nylon trolley construction
- Rotating mast up to 360 degrees with Flip up rotation handle
- Permanent and portable mounted designs available
- Power assisted height adjustment capability for adjustable models
- Leveling jacks standard on the M100 with integrated fork pockets for transporting and positioning using industrial forklifts
- 3M™ Safety-Walk™ Slip Resistant walking surface (counterweight Bases)
- Additional system mobility with optional caster wheel kit

Typical properties

- Connected Safety ID Equipped
No
- Install Type
Permanent
- Manufacturing Origin
USA
- Maximum Height (Imperial)
3.6 ft, 5.6 ft
- Maximum Height (Metric)
1.1 m, 1.7 m
- Maximum Number of Users
One
- Minimum Height (Imperial)
3.6 ft, 5.6 ft
- Minimum Height

Dimensions and Classifications

- Overall Height (Metric)
0 mm, 430 mm
- Overall Length (Metric)
170 mm, 1320 mm
- Overall Width (Metric)
38 mm, 76 mm

3M™ DBI-SALA® Small Series Load Arrestor 3700300, Galvanized Cable, 660 lb Capacity, 40 ft

Part Number 3700300 3M Product Number 3700300 3M ID 7012819495

Details

- Arrests accidental fall of heavy objects
- 660 lb. (300 kg) load capacity
- 40 ft. (12.2 m) of 3/16" (5 mm) galvanized cable
- Inertia activated brake with indicator button
- Energy absorbing system
- Self retracting lifeline
- Portable and self contained system
- Heavy-duty durable construction

Typical properties

- Brands
 - DBI-SALA®
- Cable Length (Imperial)
 - 39.3 ft
- Cable Length (Metric)
 - 12 m
- Case Quantity
 - 1
- Connected Safety ID Equipped
 - No
- Dimensions
 - 8.00x4.50x10.40in
- Lifeline Material
 - Galvanized Cable
- Product Series
 - Load Arrestor™
- Product Type
 - Load Ar

Dimensions and Classifications

- Overall Length (Imperial)
 - 40 ft
- Overall Length (Metric)
 - 12.2 m

3M™ DBI-SALA® Medium Series Load Arrestor 3700800, Galvanized Cable, 1760 lb Capacity, 56 ft

Part Number 3700800 3M Product Number 3700800 3M ID 7012771889

Details

- Arrests accidental fall of heavy objects
- 1,760 lb. (800 kg) load capacity
- 56 ft. (17.1 m) of 5/16" (8 mm) galvanized cable
- Inertia activated brake with indicator button
- Energy absorbing system
- Self retracting lifeline
- Portable and self contained system
- Heavy-duty durable construction

Typical properties

- Brands
 - DBI-SALA®
- Cable Length (Imperial)
 - 55.7 ft
- Cable Length (Metric)
 - 17 m
- Case Quantity
 - 1
- Connected Safety ID Equipped
 - No
- Dimensions
 - 14.70x9.50x17.40in
- Lifeline Material
 - Galvanized Cable
- Product Series
 - Load Arrestor™
- Product Type
 - Load A

Dimensions and Classifications

- Overall Length (Imperial)
 - 56 ft

3M™ DBI-SALA® ExoFit™ X100 Safety Harness

Details

Equipped with anti-sliding dorsal D-ring pad to help greatly reduce dorsal D-ring slide

Integrated SRL adapter lets you quickly and easily connect and disconnect personal SRLs

Suspension trauma relief straps with low-profile design included

Typical properties

Belly Pad

No

Board/Seat Cushion

Yes

Board/Seat Cushion Material

Polyester

Board/Seat Hardware Material

Zinc Plated Steel

Board/Seat Material

Polyester Webbing

Body Belt

No, Yes

Body Belt Material

Polyester

Brands

DBI-SALA®

Chest Buckle Mat

3M™ DBI-SALA® Nano-Lok™ Hot Work Personal Self-Retracting Lifeline 3100561, Kevlar® Fiber Web, 6 ft

3M Product Number 3100561 3M ID 7012818541 UPC 00648250242629

Details

Constructed with Kevlar® fiber webbing
Kevlar® protected energy absorber
Quick activating speed sensing brake system
Self-locking snap hook on the lifeline
420 lbs. (190 kg) weight capacity

Typical properties

ANSI Class Level
Class 1
Average Arrest Force (Imperial)
1125 lbf (ANSI), 1125 lbf (OSHA 130 lb - 310 lb), 1125 lbf (OSHA up to 420 lb)
Average Arrest Force (Metric)
5 kN (ANSI)
Brands
DBI-SALA®
Connected Safety ID Equipped
Yes
Harness Connectio

Dimensions and Classifications

Overall Length (Imperial)
6 ft
Overall Length (Metric)
1.83 m

3M™ DBI-SALA® Nano-Lok™ Hot Work Twin-Leg Personal Self-Retracting Lifeline 3100567, Kevlar® Fiber Web, 6 ft

3M Product Number 3100567 3M ID 7012818545 UPC 00648250242681

Details

- Constructed with Kevlar® fiber webbing
- Kevlar® protected energy absorber
- Quick activating speed sensing brake system
- Self-locking snap hook on the lifeline
- 420 lbs. (190 kg) weight capacity

Typical properties

- ANSI Class Level
- Class 1
- Average Arrest Force (Imperial)
- 1125 lbf (ANSI), 1125 lbf (OSHA 130 lb - 310 lb), 1125 lbf (OSHA up to 420 lb)
- Average Arrest Force (Metric)
- 5 kN (ANSI)
- Brands
- DBI-SALA®
- Connected Safety ID Equipped
- Yes
- Harness Connectio

Dimensions and Classifications

- Overall Length (Imperial)
- 6 ft
- Overall Length (Metric)
- 1.83 m

3M™ DBI-SALA® Nano-Lok™ Hot Work Twin-Leg Personal Self-Retracting Lifeline 3100570, Kevlar® Fiber Web, 6 ft

3M Product Number 3100570 3M ID 7012818548 UPC 00648250242711

Details

Constructed with Kevlar® fiber webbing
Kevlar® protected energy absorber
Quick activating speed sensing brake system
Self-locking snap hook on the lifeline
420 lbs. (190 kg) weight capacity

Typical properties

ANSI Class Level
Class 1
Average Arrest Force (Imperial)
1125 lbf (ANSI), 1125 lbf (OSHA 130 lb - 310 lb), 1125 lbf (OSHA up to 420 lb)
Average Arrest Force (Metric)
5 kN (ANSI)
Brands
DBI-SALA®
Connected Safety ID Equipped
Yes
Harness Connectio

Dimensions and Classifications

Overall Length (Imperial)
6 ft
Overall Length (Metric)
1.83 m

3M™ DBI-SALA® Nano-Lok™ Hot Work Twin-Leg Personal Self-Retracting Lifeline 3100571, Kevlar® Fiber Web, 6 ft

3M Product Number 3100571 3M ID 7012818549 UPC 00648250242728

Details

Constructed with Kevlar® fiber webbing
Kevlar® protected energy absorber
Quick activating speed sensing brake system
Self-locking snap hook on the lifeline
420 lbs. (190 kg) weight capacity

Typical properties

ANSI Class Level
Class 1
Average Arrest Force (Imperial)
1125 lbf (ANSI), 1125 lbf (OSHA 130 lb - 310 lb), 1125 lbf (OSHA up to 420 lb)
Average Arrest Force (Metric)
5 kN (ANSI)
Brands
DBI-SALA®
Connected Safety ID Equipped
Yes
Harness Connectio

Dimensions and Classifications

Overall Length (Imperial)
6 ft
Overall Length (Metric)
1.83 m

3M™ DBI-SALA® Nano-Lok™ Hot Work Self-Retracting Lifeline with Quick Connect 3100559, Web, Steel Rebar Lock Hook, 6 ft

3M Product Number 3100559 3M ID 7012818540 UPC 00648250242605

Details

Constructed with Kevlar® fiber webbing
Kevlar® protected energy absorber
Quick activating speed sensing brake system
Self-locking snap hook on the lifeline
420 lbs. (190 kg) weight capacity

Typical properties

ANSI Class Level
Class 1
Average Arrest Force (Imperial)
1125 lbf (ANSI), 1125 lbf (OSHA 130 lb - 310 lb), 1125 lbf (OSHA up to 420 lb)
Average Arrest Force (Metric)
5 kN (ANSI), 5 kN (OSHA up to 420 lb)
Brands
DBI-SALA®
Connected Safety ID Equipp

Dimensions and Classifications

Overall Length (Imperial)
6 ft
Overall Length (Metric)
1.83 m

3M™ DBI-SALA® SecuraSpan™ I-Beam HLL Stanchion with Base 7400047, 1 ea

Part Number 7400047 3M Product Number 7400047 3M ID 7100220291

Details

- Fits 6 in. to 12 in. (15.2-30.5 cm) wide flange up to 2-1/4" (5.7 cm) thick
- Various lengths and individual components are available
- Equipped with RFID
- Single and multi-span indefinite length system configurations
- Pass-thru 100% tie-off protection
- Simple clamp and wing nut installation
- Flexible system capacity
- Durable, lightweight and portable construction
- Top mounted adjustment system
- Single and multi-span indefinite length system configurations

Typical properties

- Brands
 - DBI-SALA®
- Case Quantity
 - 1
- Connected Safety ID Equipped
 - Yes
- For Use With
 - 3M™ DBI-SALA® SecuraSpan™ I-Beam System
- Install Type
 - Temporary/Portable
- Lifeline Material
 - Order separately
- Maximum Number of Workers
 - 2 Per Span, 6 Total
- Net Weigh

3M™ DBI-SALA® Rope Lifeline with Snap Hook

Details

Available in various sizes including 1/2" (12.7 mm) and 5/8" (16 mm)
Available in polyester, nylon and polyester/ polypropylene construction
Available in kit configurations with snap hook or in cut lengths only
Includes Snap Hook

Typical properties

Anchor Connection Type
Snap Hook
Attachment Type
None
Case Quantity
1
Connected Safety ID Equipped
No
Connector Material
Snap Hook
Install Type
Temporary
Lifeline Length (Imperial)
30 ft, 50 ft, 75 ft, 100 ft, 150 ft, 200 ft, 250 ft, 350 ft

Dimensions and Classifications

Overall Length (Imperial)
25 ft, 30 ft, 50 ft, 75 ft, 100 ft, 125 ft, 150 ft, 175 ft, 200 ft, 350 ft

3M™ Hard Hat Suspension Replacement H-700-RS4, 4-point Ratchet Standard, 20 EA/Case

3M Product Number H-700-RS4 3M ID 7000002421 UPC 10078371642119

Details

Approved replacement part for 3M H-700 series hard hats
4-point ratchet suspension allows wearer to customize height and fit
Standard brow pad offers comfort
Ratchet system operates smoothly
Replacement part can extend service life of 3M H-700 series hard hats

Typical properties

Brands
3M™
Case Quantity
20
Compatible Hard Hat
H-700, H-700T, H-800
For Use With
3M™ Headgear Systems, Hard Hats
High Heat
Yes
Material
HDPE
Product Color
Black
Product Series
H-700
Product Type
Suspension for helmets
Recommended Indust

Dimensions and Classifications

Overall Height (Imperial)
5.5 in
Overall Height (Metric)
13.97 cm
Overall Length (Imperial)
7 in
Overall Length (Metric)
17.78 cm
Overall Width (Imperial)
8.5 in
Overall Width (Metric)
21.59 cm

3M™ Hard Hat Suspension Replacement H-700-PS4, 4-point Pinlock Standard, 20 EA/Case

3M Product Number H-700-PS4 3M ID 7000002422 UPC 10078371642126

Details

Approved replacement part for 3M H-700 series hard hats
4-point pinlock suspension is easy to change out
Snap and lock system offers convenient installation and adjustment
Standard brow pad offers comfort
Replacement part can extend service life of 3M H-700 series hard hats

Typical properties

Brands
3M™
Case Quantity
20
Compatible Hard Hat
H-700, H-700T, H-800
For Use With
3M™ Headgear Systems, Hard Hats
High Heat
Yes
Material
HDPE
Product Color
Black
Product Series
H-700
Product Type
Suspension for helmets
Recommended Indust

Dimensions and Classifications

Overall Height (Imperial)
5.5 in
Overall Height (Metric)
13.97 cm
Overall Length (Imperial)
7 in
Overall Length (Metric)
17.78 cm
Overall Width (Imperial)
8.5 in
Overall Width (Metric)
21.59 cm

3M™ Clip-on Welding Shield Kit 7990/7990-AM, Accessory 1 EA/Case

3M Product Number 7990/7990-AM 3M ID 7000126524 UPC 00051131527898

Details

Clip on welding adapter can be used in conjunction with the 3M™ Full Facepieces
Compatible with standard 4.5 by 5.25 inch lens
1 each per case
For occupational use only

Typical properties

Brands
3M™
Case Quantity
1/case
Clip-on Welding Shield
Yes
Compatible Respirator
7000 Series
Compatible with 3M™ PAPR Systems
Yes
Compatible with 3M™ Supplied Air System
Yes
Compatible with Welding Shield
No
Cool Flow™ Exhalation Valve
No

3M™ Versaflo™ Gold Coated Tinted Over-Visor with UV/IR Protection M-967N, 1 EA/Case

3M Product Number M-967N 3M ID 7100154128 UPC 00076308942755

Details

Protects against UV/IR, and sparks and splashes
Modular
Over-visor
Tinted

Typical properties

Brands
Versaflo™
Compatible Respirator Type
SAR
Compatible With
3M™ Versaflo™ M-961N Over-visor Frame
Coupling Size
0.25" MPT, 3/8" Body Size, Industrial Interchange
Headgear Type
Headcover
High Heat
Yes
Material
Aluminized Fabric
Product Co

Dimensions and Classifications

Overall Length (Imperial)
19.69 in
Overall Length (Metric)
50.01 cm
Overall Width (Imperial)
9.84 in
Overall Width (Metric)
24.99 cm

3M™ Versaflo™ Replacement Visor Pivot Kit M-960, 1 Pair EA/Case

3M Product Number M-960 3M ID 7000127694 UPC 00051131173323

Details

Replacement part for all 3M™ Versaflo™ M-Series products

Typical properties

Brands

Versaflo™

Case Quantity

1

Compatible With

Versaflo™ M-Series

Headgear Type

Headcover

High Heat

No

Product Series

M-Series

Product Type

Hardware

3M™ PELTOR™ Optime™ 105 Earmuffs

Details

Noise Reduction Rating (NRR) between 27–30 dB (depending on the attachment type)

Double-shell technology boosts noise-blocking ability

Made with soft, foam-filled cushions

Stainless steel construction resists bending and warping

3M™ E-A-Rfit™ Dual-Ear Validation System testable

Typical properties

Attenuation Rating

30.0 Decibel, 29.0 Decibel

Bluetooth

No

Case Quantity

10

Corded

No

Dielectric

No

Earmuff Style

Behind the Head, Hard Hat Attached, Over the Head

Electrically Insulated

No

Hearing Protection Style

Behind-the-Head, Hard Hat

3M™ DBI-SALA® Lad-Saf™ Cable Vertical Safety System Label & Instructions

3M ID B5005039019

Details

- Ideal for use on various structure and ladder types
- Re-engineered to simplify and speed up the installation process
- Fewer parts up to 72% less than previous models
- Pre-Swaged cable design in various lengths and types
- 100% tie-off capability with integrated fall arrest-rated anchor point on top bracket
- Mounting brackets designed to fit multiple rung profiles, sizes, styles and spacing
- Top and bottom brackets sold together as a system for ordering convenience
- Equipped with 3M™ Connected Safety ID (CSID)

3M™ E-A-R™ Pistonz™ Earplugs P1400, Uncorded, 400 Pair/Case

Part Number 93401 3M Product Number 01400 3M ID 7000127672

Details

No roll-down, easy-insertion design keeps tip clean even if hands are dirty
Push-to-fit stem flexes sideways if impacted during wear
Officially licensed hearing protection of NASCAR combines style with function
Cylindrical shape fits most ears comfortably
Noise reduction rating (NRR) 29 dB CSA Class AL

Typical properties

Attenuation Rating
29.0 Decibel
Banded
No
Brands
E-A-R™
Case Quantity
400
Cord Type
None
Corded
No
Dielectric
No
Dispenser Available
No
Earplug Color
Gray
Earplug Material
Foam/Thermoplastic
Earplug Shape
Cylinder
Earplug Size
Regul

3M™ E-A-R™ Pistonz™ Earplugs P1401, Corded, 400 Pair/Case

3M Product Number 01401 3M ID 7000127673 UPC 10093045934024

Details

No roll-down, easy-insertion design keeps tip clean even if hands are dirty
Push-to-fit stem flexes sideways if impacted during wear
Officially licensed hearing protection of NASCAR combines style with function
Cylindrical shape fits most ears comfortably
Noise reduction rating (NRR) 29 dB CSA Class AL
Cord allows earplugs to be stored conveniently around the neck in between uses

Typical properties

Attenuation Rating
29.0 Decibel
Banded
No
Brands
E-A-R™
Case Quantity
400
Cord Color
Gray
Cord Type
Vinyl
Corded
Yes
Dielectric
No
Dispenser Available
No
Earplug Color
Gray
Earplug Material
Foam/Thermoplastic
Earplug Shape
Cylinder

3M™ Breathing Tube Clamp RBE-CMP 1 EA/Case

3M Product Number RBE-CMP 3M ID 7010340259 UPC 00051131918962

Details

This breathing tube is used in the 3M™ Powered Air Purifying Respirator (PAPR) Hood Systems RBE-NM10 and RBE-L10

Typical properties

Brands

3M™

Product Color

Black

Product Series

Breathe Easy

Product Type

Breathing Tubes

3M™ PAPR Batteries

Details

Easy to install on PAPR
Easy determination of charge level

Typical properties

Battery Life

12 Hour, 4 - 12 Hours, 4 - 8 Hours, 8 - 18 Hours, 8 hr, 8 hr - 12 hr

Battery Type

High Capacity Lithium Ion - Rechargeable, Lithium-ion Rechargeable, NiCd - Rechargeable, Non-Rechargeable Lithium-ion

Brands

3M™

Case Quantity

1

Compati

3M™ Versaflo™ PAPR Cover TR-681, for TR-600/800 PAPR, 10 ea/Case

3M Product Number TR-681 3M ID 7100260718 UPC 50638060432162

Details

PAPR cover helps keep PAPR clean from debris
Made with liquid resistant material
Compatible with 3M™ Versaflo™ TR-600/800 PAPRs
Popular for paint spray application
Made with no natural rubber latex components
The TR-681 covers the PAPR blower, breathing tube and belt

Typical properties

Air Source
PAPR
Brands
Versaflo™
Cartridge or Filter Included
No
Case Quantity
10
Compatible Respirator Type
PAPR
Compatible With
3M™ Versaflo™ TR-600 Series PAPR, 3M™ Versaflo™ TR-800 Series PAPR
Cool Flow™ Exhalation Valve
No
Includes
10

3M™ Versaflo™ PAPR Cover TR-381, for TR-300+ PAPR, 10 ea/Case

3M Product Number TR-381 3M ID 7100260719 UPC 50638060431974

Details

PAPR cover helps keep PAPR clean from debris
Made with liquid resistant material
Compatible with 3M™ Versaflo™ TR-300+ PAPR
Popular for paint spray application
Made with no natural rubber latex components
The TR-381 covers the PAPR blower and breathing tube

Typical properties

Air Source
PAPR
Brands
Versaflo™
Cartridge or Filter Included
No
Case Quantity
10
Compatible Respirator Type
PAPR
Compatible With
3M™ Versaflo™ TR-300+ Series PAPR
Cool Flow™ Exhalation Valve
No
Includes
10 PAPR Covers
Maintenance Free
Ye

3M™ Shower Cover RBE-SC 2 EA/Case

3M Product Number RBE-SC 3M ID 7000126950 UPC 50051131985464

Details

Helps protect the 3M™ RBE PAPR Assemblies RBE-40 and RBE-57 from moisture, but does not eliminate moisture entry completely
For use by first responders, law enforcement, military and health care professionals

Typical properties

Brands
3M™
Compatible With
3M™ Breathe Easy™ PAPR
Product Series
Breathe Easy
Product Type
Shower Cover

3M™ Versaflo™ Radiant Heat Cover M-975N, for M-407, 1 EA/Case

3M Product Number M-975N 3M ID 7100154130 UPC 00076308942731

Details

Modular range allows for multiple combinations and different coverage levels

Compatible with 3M™ Versaflo™ Helmet M-407

Modular

Protects against radiant heat

Typical properties

Brands

Versaflo™

Compatible Respirator Type

SAR

Compatible With

3M™ Versaflo™ M-306 Helmet, 3M™ Versaflo™ M-407 Helmet

Coupling Size

0.25" MPT, 3/8" Body Size, Industrial Interchange

Headgear Type

Headcover

High Heat

Yes

Material

Aluminized F

3M™ Versaflo™ Radiant Heat Cover M-973, for M-307, 1 EA/Case

3M Product Number M-973N 3M ID 7100154129 UPC 00076308942724

Details

Protects against radiant heat
Modular
Modular
Protects against radiant heat

Typical properties

Brands
Versaflo™
Compatible Respirator Type
SAR
Compatible With
3M™ Versaflo™ M-307 Hard Hat Assembly
Coupling Size
0.25" MPT, 3/8" Body Size, Industrial Interchange
Headgear Type
Headcover
High Heat
Yes
Material
Aluminized Fabric
Product Co

3M™ Versaflo™ TR-600 & TR-800 Series PAPR Filters

Details

Compatible with the 3M™ Versaflo™ TR-600 and TR-800 PAPR systems
High efficiency filter
Respiratory protection against dusts, mists, fumes and other particulate hazards,
and a variety of gas and vapor hazards, including organic vapor and acid gas
Simple to install

Typical properties

Case Quantity
5,40
Compatible Respirator
TR-600 Series, TR-800 Series
Compatible with 3M™ PAPR Systems
Yes
Hazard Type
Silica
Mounting Type
Belt-mounted
NIOSH Cartridge or Filter Assigned Color Coding
Magenta, Magenta/Black, Magenta/Green, Mage

3M™ DBI-SALA® Lad-Saf™ Cable Guide

Details

Bypassable intermediate cable guide for Lad-Saf™ System

Fast, easy and safe installation

Rugged and corrosion resistant galvanized mounting hardware

Order top and bottom brackets, stand-offs, guide supports, cable and sleeve separately

Non-metallic guide prevents metal-to-metal contact

Typical properties

Attachment Type

Bolt on One Rung, Bolt-On, One Rung

Case Quantity

1

Connected Safety ID Equipped

No

Dimensions

5.7 in x 2.6 in x 1.2 in, 8.7 in x 1.5 in x 1.2 in, 6.9 in x 1.5 in x 1.2 in

For Use With

Fixed Ladders, Steel Pole, Steel Pole/Tower, Wo

3M™ 7093 P100 Replacement Filters for the 3M™ 62093 Mold & Lead Paint Removal Respirator

3M ID 70006983384 UPC 00051141905211

Details

NIOSH-APPROVED P100 filters for at least 99.97% filtration efficiency against solids and liquid aerosols, as well as oils
FOR WORKPLACE/OCCUPATIONAL USE ONLY
OIL PROOF (Use according to manufacturer's time use restrictions when oil aerosols are present)
INTENDED FOR THE PROFESSIONAL REMOVAL of mold, lead-based paints, woodworking and working with fiberglass insulation
APPROVED FOR USE WITH 3M™ 6000, 6500 AND 7500 SERIES FACEPIECES
EASY-TO-ATTACH DESIGN
Facepiece is not included
Use this product in accordance with all applicable respiratory protection requirements including OSHA Lead Standard and US-EPA Guidelines for mold
Label Color: Magenta
Package Contents: 1 pair

Typical properties

Brands
3M™
Cartridge or Filter Included
Yes
Cartridge or Filter Type
Combination
Case Quantity
5 Packs/Case
Catalog Number
7093H1-DC
Clip-on Welding Shield
No
Compatible with 3M™ PAPR Systems
No
Compatible with 3M™ Supplied Air System
No
C

Dimensions and Classifications

Overall Height (Imperial)
8.2 in
Overall Height (Metric)
20.828 cm
Overall Length (Imperial)
4.38 in
Overall Length (Metric)

11.1125 cm
Overall Width (Imperial)
4.6 in
Overall Width (Metric)
11.684 cm

3M™ Scott™ EPIC 3 RDI Voice Communication System

3M ID B5005046024

Details

Clear communication when and where you need it
Operates with compatible handheld field radios and remote speaker microphones
Works with a broad range of 3M Scott SCBA and PPE equipment
Multi-purpose utility consolidates devices while reducing costs
User friendly operation and ergonomics
Durable, reliable purpose-built design with high-heat rated construction
Easy and flexible device configuration

Typical properties

Brands
Scott™
Connection Type
Wireless
Product Type
Respiratory Communication Device

3M™ Scott™ Ska-Pak AT Supplied-Air Respirator

3M ID B5005047152

Details

Combination Type C positive pressure respirator with escape cylinder for entry into and escape from hazardous, confined space, or immediately dangerous to life or health (IDLH) situations

Automatic, hands-free transfer from external air source to cylinder in the event of primary air source interruption

Personal, tactile and audible Vibralert alarm to alert users of transfer to cylinder air

Available with either a padded Kevlar® harness, a padded nylon harness or integrated full-body harness for fall protection

Available in 2216, 3000 and 4500 psi and 3, 5, 10 or 15 minute egress cylinder with “onboard” cylinder low-pressure indicator for added safety and awareness

The E-Z Flo Regulator with Vibralert is designed for easy use with gloved hands, enables easy breathing, and has a two-step secure attachment and removal to help ensure worker confidence

NIOSH-approved for use with 3M Scott AV series facepieces that can also be used for APR, PAPR, supplied air, and SCBA applications

Padded Nylon that is designed to be comfortable and lightweight

Padded fire-resistant Kevlar® for high heat environments or when there is potential for sparking

Integrated full-body harness combines 3M’s Fall Protection technology with the 3M™ Scott™ Ska-Pak Supplied-Air Respirator. This integrated solution is a NIOSH-approved respirator and suitable for confined spaces and working at height applications, providing workers with fall and respiratory protection in hazardous conditions

Typical properties

Battery Type
Alkaline

Brands
Scott™

Compatible Facepiece
AV-3000 SureSeal

Connection Type
Compressed Air Line

Product Type
Supplied Air Respirator

Specifications Met
NIOSH 42 CFR

3M™ Speaking Diaphragm Kit 7895, 2 EA/Case

3M Product Number 7895 3M ID 7000051802 UPC 50051138174946

Details

Approved 3M™ replacement part
Designed for use with 3M™ Full Facepiece 7000 Series (sold separately)
Kit includes speaking diaphragm, gasket, retainer, and removal tool
Replacement speaking diaphragm can extend service life of facepiece
Replaceable part can potentially result in respiratory equipment cost savings

Typical properties

Accessories
No
Boxes per Case
2
Brands
3M™
Cartridge or Filter Included
No
Case Quantity
2/case
Clip-on Welding Shield
No
Compatible with 3M™ PAPR Systems
No
Compatible with 3M™ Supplied Air System
No
Eye Protection
No
Kit Type
Reusable

3M™ Scott™ Air-Pak™ X3 Pro SCBA

3M ID B5005047169

Details

Compliant to NFPA 1981, Standard on Open-Circuit Self-Contained Breathing Apparatus (SCBA) for Emergency Services, 2018 Edition

Compliant to NFPA 1982, Standard on Personal Alert Safety Systems (PASS), 2018 Edition

New harness materials offer greater resistance to chemical exposure and less water absorption to help minimize contamination

Easy-to-remove harness allows for cleaning to help with exposure reduction

New shoulder harness design improves the ease of donning and minimizes pressure points to help reduce user fatigue

Natural articulation (i.e. waist pad) promotes greater range of motion to the user, while transferring weight to the hips for a more balanced load

Proven regulator design offers low breathing resistance to help reduce user burden and improve operational efficiencies

Redundant safety features afford firefighters peace of mind knowing that the SCBA will perform in the toughest environments

3M™ Scotchlite™ Reflective Material delivers enhanced visibility of the SCBA when operating in low-light conditions, improving safety and accountability on the fireground

Bluetooth® enabled electronics support wireless connectivity between devices for improved configurability, data transmission/retrieval, firefighter safety and fireground accountability

Electronic personnel accountability report (ePAR) provides wireless, bi-directional communication between the firefighter and incident command (using Monitor Pro telemetry software) to help improve fireground accountability and communications

System Integrity Alarm provides visual and audible alerts to notify SCBA wearer and incident command (using Monitor Pro telemetry software) of impending electronics degradation due to elevated temperature

Integrated RFID tags provide local storage of SCBA information that can be wirelessly interrogated for asset tracking

Proudly “Made in the USA” with attention to quality and workmanship

High-Flow Alarm provides visual and audible alerts (using Monitor telemetry software) to notify incident command of a high-flow condition from a firefighter’s SCBA during a full-alarm PASS activation (i.e. heavy breathing, free flow, etc.)

Typical properties

Airline Connector Brand

None

Brands

Scott™

Harness Material

Kevlar®

Included Regulator

E-Z Flo+

Product Type

3M™ Secure Click™ Speaking Diaphragm Assembly, HF-800-05, 5 EA/Bag

3M Product Number HF-800-05 3M ID 7100181934 UPC 04054596622005

Details

Replacement part for 3M™ Secure Click™ Half Facepiece Reusable Respirator HF-800 Series

Designed to help provide easier communication while you work

Replacement speaking diaphragm can extend the service life of HF-800 Series facepieces and potentially result in cost savings

For workplace/occupational use only

Package contents: 1 case contains 5 each replacement speaking diaphragms

Typical properties

Accessories

Yes

Brands

Secure Click™

Case Quantity

5

Clip-on Welding Shield

No

Compatible Respirator

Secure Click™ HF-800 Series Half Facepiece Reusable Respirators

Compatible with 3M™ PAPR Systems

No

Compatible with 3M™ Supplied Air System

N

Dimensions and Classifications

Overall Height (Metric)

42.8 mm

Overall Length (Metric)

12.4 mm

Overall Width (Metric)

42.8 mm

3M™ Speaking Diaphragm Assembly FF-400-13, 5 EA/Case

3M Product Number FF-400-13 3M ID 7000052742 UPC 50051135894854

Details

Replacement part to use with 3M Ultimate FX Full Facepiece Reusable Respirators FF-401, FF-402, and FF-403 (sold separately)
Designed for use with the 3M Ultimate FX Full Facepiece Reusable Respirators (sold separately)
Maintains original performance standards of facepiece
Replacement assembly for speaking diaphragm
Replaceable part can potentially result in respiratory equipment cost savings

Typical properties

Accessories
Yes
Boxes per Case
5
Brands
3M™
Case Quantity
5/case
Clip-on Welding Shield
No
Compatible Respirator
FF-400 Series
Compatible with 3M™ PAPR Systems
No
Compatible with 3M™ Supplied Air System
Yes
Compatible with Welding Shield

3M™ DBI-SALA® Pole Climber's Adjustable Web Positioning Lanyard

Details

Ideal for work positioning while pole climbing
Durable kernmantle rope with wear indicator
Abrasion resistant sleeve
Lightweight aluminum self locking carabiner at one end
Lightweight aluminum rope adjuster and carabiner at one end

Typical properties

Anchor Connection Type
None
Case Quantity
1
Connected Safety ID Equipped
No, Yes
Energy Absorber Class
None
For Use With
Electrical Use, Hot Work Use
Harness Connection Hook Material
Aluminum, Zinc Plated Steel
Harness Connection Type
Carabin

Dimensions and Classifications

Overall Length (Imperial)
8 ft

3M™ DBI-SALA® Confined Space Overload Clutch 8512936, 1 EA

Part Number 8512936 3M Product Number 8512936 3M ID 7100204062

Details

Overload protection clutch
For confined space digital series power drive winches
Maximum working load of 450 lbs. (204 kg)
Durable aluminium and steel construction
Compact and lightweight design

Typical properties

Brands
DBI-SALA®
Case Quantity
1
Connected Safety ID Equipped
No
For Use With
Power Drive Digital Winches
Net Weight (Imperial)
3.8 lb
Net Weight (Metric)
1.7 kg
Product Color
Black
Product Series
Advanced™
Product Type
Overload Clutch
R

3M™ Welding Headbands & Headband Components

Details

Highly adjustable and comfortable with a smooth ratchet for precise tightening
For highest possible safety and comfort, regularly check your equipment for worn or damaged parts
Includes assembly parts

Typical properties

Brands

Speedglas™

Case Quantity

1,5

Compatible Welding Helmet

100 Series, 9100 Series, G5-01 Welding Helmets, G5-02 Welding Helmets, SL Series

Features

100 Series Accessory, 9100 Series Accessory, SL Series Accessory

For Use With

3M™ Speedglas™ 9

3M™ Scotchlite™ Reflective Material 8907 Silver Fabric, Config Roll

3M Product Number 8907 3M ID 7100121726

Details

3M™ Scotchlite™ Reflective Material is designed for enhancing visibility in low light and nighttime conditions
Certified to various global high visibility standards such as ANSI/ISEA 107
Backside printed for authentication
Sew-on application

Typical properties

Adhesive
None
Attachment Type
Sew On
Brands
Scotchlite™
Certified Performance Required
ANSI 107-2015, CSA Z95-2015
Daytime Color
Silver
Initial Average RA
500
Product Series
8907
Technology
Beaded
Wash Cycles per ANSI 107-2015
30

3M™ DBI-SALA® Nano-Lok™ Connected Extended Length Order Picker Self-Retracting Lifeline Kit 3100273, Web, 11 ft

3M Product Number 3100273 3M ID 7100264408 UPC 00648250179369

Details

Fall Protection system provides audible and visual alert of worker tie off status
Detects associate's presence as they move on and off order picker platform
Works with all metallic OSHA rated dorsal D-ring's
Non disruptive and encourages safe connection and situational awareness
Lightweight aluminum snap hook with plastic cover
A modular system designed for replacement parts that can be ordered separately and installed easily
11' (3.4 m) Dynema™ fiber and polyester web lifeline

Typical properties

Anchor Connection Type
Cab-mount Bracket
Anchor Hook Material
Aluminum
Brands
DBI-SALA®
Connected Safety ID Equipped
Yes
Harness Connection Type
Connected Carabiner
Housing Material
Nylon Thermoplastic
Install Type
Reusable or Permanent
Life

Dimensions and Classifications

Overall Length (Imperial)
11 ft
Overall Length (Metric)
3.35 m

3M™ DBI-SALA® Web Scaffold Choker

Details

Lightweight and durable polyester web construction
Meets the requirements for 29 CFR OSHA 1910.140, and OSHA 1926.502
Recommended for use in multiple industries including construction, mining, oil and gas, transportation, utilities, and wind energy
Adjustable designs available to accommodate a variety of different sized structures
Compatible with various fall arrest systems
This safety equipment is designed for use with additional personal fall arrest systems
Features high-strength steel hardware
Portable and reusable
Ideal anchorage device for scaffolding or piping
Variable length web scaffold choker with D-ring and web loop

Typical properties

Anchor Install Type
Reusable
Attachment Type
Pass-through/Choker
Case Quantity
1
Connected Safety ID Equipped
No
Install Type
Reusable
Material
Polyester Web
Product Color
Yellow
Product Type
Web Scaffold Choker
Recommended Industry
Const

Dimensions and Classifications

Overall Length (Imperial)
1.4 ft, 2 ft, 2.5 ft, 3 ft, 4 ft

3M™ DBI-SALA® Lad-Saf™ Cable Vertical Safety System Bracketry For Wood Pole 6116635, 2 User, Galvanized Steel

Part Number 6116635 3M Product Number 6116635 3M ID 7100261159

Details

Designed to meet the requirements of the ANSI Z359.16 standard, along with OSHA 1910.140 and 1926.502, when used with our Lad-Saf X3 Detachable Cable Sleeve (6160054) and Lad-Saf X2 Detachable Cable Sleeve (6160030)
Reengineered to simplify and speed up the installation process
Flexible: Mounting brackets can be used on a variety of fixed ladder styles that may consist of different rung spacings and shapes
Light – weighs less than previous 3M systems

Typical properties

Brands
DBI-SALA®
Case Quantity
1
Connected Safety ID Equipped
Yes
Install Type
Permanent
Product Color
Silver
Product Series
Lad-Saf™
Product Type
Vertical Safety System Bracketry
Recommended Application
Utility Power Maintenance, Utility T

3M™ DBI-SALA® Lad-Saf™ Cable Vertical Safety System Bracketry with Telescoping Extension 6116618, 4 User, Galvanized Steel

Part Number 6116618 3M Product Number 6116618 3M ID 7100261157

Details

Designed to meet the requirements of the ANSI Z359.16 standard, along with OSHA 1910.140 and 1926.502, when used with our Lad-Saf X3 Detachable Cable Sleeve (6160054) and Lad-Saf X2 Detachable Cable Sleeve (6160030)
Reengineered to simplify and speed up the installation process
Flexible: Mounting brackets can be used on a variety of fixed ladder styles that may consist of different rung spacings and shapes
Light – weighs less than previous 3M systems

Typical properties

Brands
DBI-SALA®
Case Quantity
1
Connected Safety ID Equipped
Yes
Install Type
Permanent
Product Color
Silver
Product Series
Lad-Saf™
Product Type
Vertical Safety System Bracketry
Recommended Application
Billboard Maintenance, Egress Access

3M™ DBI-SALA® Permanent Roof Top Anchor For PVC Membrane/Built-Up 2100140, with Weather Proof Shroud

Part Number 2100140 3M Product Number 2100140 3M ID 7100314284

Details

Durable materials and hardware designed to help stand up to harsh working conditions
Compatible with various fall arrest systems
Suitable for use in general industrial and construction industries
Compact, lightweight design
Meets the requirements for 29 CFR OSHA 1910.140 and 29 CFR OSHA 1926.502
Features corrosion-resistant, steel and aluminum construction for durability
This safety equipment is designed for use with additional personal protective equipment (PPE)
Installs to single ply PVC membrane and built-up type roofs. For use on flat or sloped (up to 3:12 pitch) roofs
Swiveling tie-off point for complete mobility. Load distributing design protects roof and user
Multiple fastener options available

Typical properties

Anchor Install Type
Permanent
Anchor Type
Roofing
Attachment Type
Toggle Bolt
Brands
DBI-SALA®
Case Quantity
1
Connected Safety ID Equipped
No
Dimensions
16.00x16.00x9.00in
For Use With
PVC Roofs
Install Type
Permanent
Material
Zinc Pla

3M™ DBI-SALA® Lad-Saf™ Cable Vertical Safety System Bracketry For Monopole 6116634, 4 User, Galvanized Steel

Part Number 6116634 3M Product Number 6116634 3M ID 7100261158

Details

Designed to meet the requirements of the ANSI Z359.16 standard, along with OSHA 1910.140 and 1926.502, when used with our Lad-Saf X3 Detachable Cable Sleeve (6160054) and Lad-Saf X2 Detachable Cable Sleeve (6160030)
Reengineered to simplify and speed up the installation process
Flexible: Mounting brackets can be used on a variety of fixed ladder styles that may consist of different rung spacings and shapes
Light – weighs less than previous 3M systems

Typical properties

Brands
DBI-SALA®
Case Quantity
1
Connected Safety ID Equipped
Yes
Install Type
Permanent
Product Color
Silver
Product Series
Lad-Saf™
Product Type
Vertical Safety System Bracketry
Recommended Application
Grain Bin Maintenance, Grain Silo Ma

3M™ DBI-SALA® Lad-Saf™ Cable Vertical Safety System Bracketry For Monopole 6116638, 4 User, Stainless Steel

Part Number 6116638 3M Product Number 6116638 3M ID 7100248361

Details

Designed to meet the requirements of the ANSI Z359.16 standard, along with OSHA 1910.140 and 1926.502, when used with our Lad-Saf X3 Detachable Cable Sleeve (6160054) and Lad-Saf X2 Detachable Cable Sleeve (6160030)
Reengineered to simplify and speed up the installation process
Flexible: Mounting brackets can be used on a variety of fixed ladder styles that may consist of different rung spacings and shapes
Light – weighs less than previous 3M systems

Typical properties

Brands
DBI-SALA®
Case Quantity
1
Connected Safety ID Equipped
Yes
Install Type
Permanent
Product Color
Silver
Product Series
Lad-Saf™
Product Type
Vertical Safety System Bracketry
Recommended Application
Grain Bin Maintenance, Grain Silo Ma

3M™ M-Series PAPR Helmet & Helmet Assemblies

Details

M-Series are specifically designed to work together with your 3M™ Versaflo™ and 3M™ Supplied Air Respiratory Systems
Deflector allows users to direct the airflow inside the headtop to increase comfort
Fully-adjustable suspension for customized fit and weight distribution
Accessory options available for protection to help handle the environments you encounter
Visor combines good peripheral and downward vision
Can be used with a range of 3M™ Peltor™ hearing protection as well as an attachable microphone for ease of communication

Typical properties

Assigned Protection Factor

1000, 25

Brands

3M™

CFM Capacity per Minute

100 CFM, 50 CFM

Case Quantity

1

Compatible With

3M™ Versaflo™ M-300 Parts & Accessories, 3M™ Versaflo™ M-400 Series Helmets, 3M™ Versaflo™ System

Features

Easy Visor Replace

3M™ Secure Click™ Multi-Gas/Vapor Cartridge D8006, 60 ea/Case

3M Product Number D8006 3M ID 7100153228 UPC 00051141566627

Details

Secure Click™ connection style enables a quick, simple connection of cartridges
Secure Click™ cartridges are dual-flow to allow easy breathing and greater comfort

Use with NIOSH-approved 3M™ Secure Click™ Facepieces

NIOSH-approved for protection against certain organic vapors, sulfur dioxide, hydrogen chloride, chlorine/ammonia/methylamine/formaldehyde or chlorine dioxide or hydrogen fluoride or hydrogen sulfide

Swept-back design for enhanced field of view and comfort

For workplace/occupational use applications only

Package contents: 1 case contains 30 pairs of filters (60 each)

Typical properties

Accessories

No

Brands

Secure Click™

Cartridge or Filter Type

Gas & Vapor

Clip-on Welding Shield

No

Compatible Respirator

3M™ Secure Click™ Half Facepiece Reusable Respirators HF-800 Series

Compatible with 3M™ PAPR Systems

No

Compatible with 3M

Dimensions and Classifications

Overall Height (Metric)

34 mm

Overall Length (Metric)

105 mm

Overall Width (Metric)

89 mm

3M™ Secure Click™ Organic Vapor Cartridge D8001, 60 ea/Case

3M Product Number D8001 3M ID 7100153170 UPC 00051131374669

Details

Secure Click™ connection style enables a quick, simple connection of cartridges
Secure Click™ cartridges are dual-flow to allow easy breathing and comfort
Use with NIOSH-approved 3M™ Secure Click™ Facepieces
NIOSH-approved for use against certain organic vapors
Swept-back design for enhanced field of view and comfort
For workplace/occupational use only
Package contents: 1 case contains 30 pairs of filters (60 each)

Typical properties

Accessories

No

Brands

Secure Click™

Cartridge or Filter Type

Gas & Vapor

Clip-on Welding Shield

No

Compatible Respirator

3M™ Secure Click™ Half Facepiece Reusable Respirators HF-800 Series

Compatible with 3M™ PAPR Systems

No

Compatible with 3M

Dimensions and Classifications

Overall Height (Metric)

34 mm

Overall Length (Metric)

105 mm

Overall Width (Metric)

89 mm

3M™ Protective Coverall 4520

Details

Two-way zipper with sealable storm flap helps provide additional protection against contaminants

Anti-static treatment can help reduce static build-up

Does not contain natural rubber latex components

Seamless shoulders and sleeve tops offer extra strength and protection

Extra-roomy design in arms and legs deliver enhanced mobility

Recommended for use in multiple industries including general manufacturing, mining, construction, transportation and more

Available in collared and hooded profiles

Available in a wide range of sizes

20 or 25 units are included in each case

Typical properties

Additional Protection Features

Antistatic Protection, Radioactive Particulate Protection

Closure Method

Two-way Zipper

Coverall Style

Collared, Hooded

Features

3 Panel Hood, Anti-static, Collar (No Hood), Elastic Waist, Elastic Waist & Ankle, Knitt

3M™ Speedglas™ 9100 FX-Air Replacement Spring Mechanism 06-0400-56, 2 ea/Bag

3M Product Number 06-0400-56 3M ID 7100215111 UPC 00051131278332

Details

Replacement part only
For use with 9100 FX and 9100 FX-Air Welding Helmets
User can easily install

Typical properties

Brands
Speedglas™
Compatible Welding Helmet
9100 FX Welding Helmets, 9100 FX-Air Welding Helmets
For Use With
3M™ Speedglas™ 9100FX Welding Helmets, 3M™ Speedglas™ 9100FX-Air
Welding Helmets
Product Color
Black
Product Series
9100, 9100 FX-Air
P

3M™ Solus™ 2000 Series Safety Glasses

Details

Adjustable ratchet temples allows user to adjust lens for facial features and eyeglass position

Contemporary styling with padded temples and soft nosebridge for added comfort

Choose from models with anti-fog/anti-scratch or 3M™ Scotchgard™ Anti-Fog coating

U6 rated polycarbonate lenses absorb 99.9% of UVA, UVB, and UVC rays between 200 nm and 380 nm

Workers can feel confident wearing 3M eye protection that meets the Impact-Rated Protector requirement of the ANSI-ISEA Z87.1-2020 Standard

Typical properties

Anti Fog Lens

No, Yes

Brands

Solus™

Case Quantity

20

Class

Premium

Comfort Features

Adjustable lens angles, Color-accented temples, Dual-injected, Durable construction, Lens angle adjustment, Multiple Lens Angles, Polycarbonate lens, Sporty wrap

3M™ SecureFit™ Hard Hat Non-Vented Full Brim with Ratchet Adjustment, Orange, 1 Ea/Pk

3M ID 70007084380 UPC 00076308421151

Details

Patented 3M™ Pressure Diffusion Technology incorporates self-adjusting front paddles along your forehead
Suspension flexes and self-adjusts, reducing forehead pressure and increasing comfort for all-day wear
Smooth-turning 4-point ratchet suspension system for custom, on-head sizing
Suspension sits low on the head to increase comfort and security
Customize your fit with multiple levels of height and head-shape adjustments
Fits hat sizes 6 ¼ to 8 (50 to 64cm head circumference)
Breathable, washable sweatband – to help keep you cool and dry
Full brim model helps protect neck and ears from UV rays
Non-vented hard hat meets ANSI Z89.1/CSA Z94.1 Type I, Class G and E requirements
Made in USA with globally sourced materials

Typical properties

Brands
3M™
Factory ISO Certification
No ISO Certification information available
eClass 14 Classification Group
40300202

3M™ Dual Cartridge Respirator Packout 07179, Organic Vapor/P95, Large

Part Number 07179 3M ID 7010339796 UPC 00051131071797

Details

Includes the 3M™ Half Facepiece 07026 (large), 1 pair organic vapor cartridges 07046, 1 pair filter retainers 07054, and 2 pairs of P 95 filters 07194 swept back cartridge design
Spray paint applications
For occupational use only

Typical properties

Brands
3M™
Particulate Protection
Organic Vapor, Particulate
Recommended Industry
Marine
eClass 14 Classification Group
40220213

3M™ Socket Dust Cap W-2119, 1 EA/Case

3M Product Number W-2119 3M ID 7000005376 UPC 00051138154899

Details

This socket is a standard fitting used with the 3M™ Compressed Air Filter and Regulator Panel W-2806. It is a 3/8 inch MPT high pressure socket made of brass

Typical properties

Brands

3M™

CFM Capacity per Minute

100 CFM, 50 CFM

Case Quantity

1/pack

Compatible With

3M™ W-2806 Filtration Panel

Pressure Type

High

Product Color

Red

Product Series

Supplied Air

Product Type

Socket

Supplied Air Respirator Style

MST Por

3M™ Versaflo™ Mining Lamp Bracket Kit M-940, for M-Series Hard Hats and Helmets, 1 ea/Case

3M Product Number M-940 3M ID 7100265324 UPC 50638060433510

Details

The bracket is made of a lightweight durable polymer
Can be used with a range of corded and cordless mining lamps
The bracket is easy to install and easy to adjust for a desired lamp angle
Designed to allow the user to lift the visor without removing mining lamp
The design helps hold mining lamps securely

Typical properties

Brands

Versaflo™

Case Quantity

1

Compatible Respirator Type

SAR

Compatible With

3M™ Versaflo™ TR-300+ Series PAPR, 3M™ Versaflo™ TR-600 Series PAPR,

3M™ Versaflo™ TR-800 Series PAPR

Maintenance Free

Yes

Mounting Type

Head-mounted

Product Color

3M™ DBI-SALA® Nano-Lok™ edge Self-Retracting Lifeline Pack Adaptor For Harness 3100184

Part Number 3100184 3M Product Number 3100184 3M ID 7012818432

Details

Pack adaptor for harness with short back straps
Attaches Nano-Lok™ edge energy absorber pack to harness
Simple hook-and-loop style installation
Lightweight and durable construction

Typical properties

Brands
DBI-SALA®
Case Quantity
1
Connected Safety ID Equipped
No
Material
Nylon
Net Weight (Imperial)
0.2 lb
Net Weight (Metric)
0.1 kg
Product Color
Orange
Product Series
Nano-Lok™ edge
Product Type
Edge Pack Adapter
Recommended Industr

3M™ DBI-SALA® Rope Tagline 7211856, 3/16 in Polypropylene, 50 ft

Part Number 7211856 3M Product Number 7211856 3M ID 7100314305

Details

Tagline for self retracting lifeline
50 ft. (15 m) 3/16" (5 mm) polypropylene rope
Attached steel O-ring
Durable materials
Compact and lightweight design

Typical properties

Brands
DBI-SALA®
Case Quantity
1
Connected Safety ID Equipped
No
Material
Polypropylene
Product Type
Tagline for Self Retracting Lifeline
Recommended Industry
Construction, General Industrial, Oil & Gas, Transportation, Utilities, Wind Energy

Dimensions and Classifications

Overall Length (Imperial)
50 ft

3M™ DBI-SALA® Tagline 7211857

3M Product Number 7211857 3M ID 7100227212 UPC 00840779081011

Details

Tagline for self retracting lifeline
25 ft. (7.6 m) 3/16" (5 mm) polypropylene rope
Attached steel O-ring
Durable materials
Compact and lightweight design

Typical properties

Brands
DBI-SALA®
Case Quantity
1
Connected Safety ID Equipped
No
Material
Polypropylene
Product Type
Tagline for Self Retracting Lifeline
Recommended Industry
Construction, General Industrial, Oil & Gas, Transportation, Utilities, Wind Energy

Dimensions and Classifications

Overall Length (Imperial)
25 ft

FUTURO™ Ultra Sheer Knee Highs for Women, Moderate Compression

3M ID CBGBLW011023 UPC 00051131215917

Details

Moderate Compression (15-20 mmHg)
Helps relieve symptoms of superficial spider veins or mild varicose veins
Ideal for standing or sitting all day, traveling or active office work
Reinforced toe, heel and durable run guard for lasting wear
Graduated compression helps improve circulation
Comfort band keeps knee highs from rolling down
Silky-soft material provides a comfortable feel
Great for business casual, evening and weekend wear
Made from a comfortable blend of nylon and spandex
Size: M, L
Color: Nude

Typical properties

Body Part
Leg
Brands
FUTURO™
Factory ISO Certification
No ISO Certification information available
Foot Style
Closed Toe
Material
Nylon, Spandex
Product Color
Nude
Product Type
Pantyhose
Product Usage
Being on Feet All Day, DVT, Swelling, Tr

Peltor™ Sport Blasts™ Disposable Earplugs 97080-10C, 3 Pair Pack, Neon Yellow

3M ID 70006944923 UPC 00078371970802

Details

Peltor Sport's highest Noise Reduction Rating (NRR) earplug at 32 dB
Soft foam expands slowly to fit comfortably
3-pair pack includes storage container to help keep plugs clean when not being worn
Easy to insert and remove
Made in U.S.A. with globally sourced materials

Typical properties

Brands
PELTOR™
Catalog Number
97080-10C
Factory ISO Certification
No ISO Certification information available
eClass 14 Classification Group
40270190

3M™ SecureFit™ 400 Eye Protection SF400G-WV-6-PS, Gray Anti-Fog, 6ea/cs

3M ID 70006963394 UPC 00076308723989

Details

Durable lenses help provide limited protection from light to moderate impact hazards

3M™ Pressure Diffusion Temple self-adjusts to provide a secure, comfortable fit

Padded temples for added comfort over the ears

Soft, conformable nose pads provide customizable comfort

Lightweight, durable design for all-day comfort and lasting wear

Sleek temples create a flush fit with ear protection

Flexible temples conform comfortably to different head sizes

Anti-fog, scratch-resistant lenses help keep vision clear

Impact-resistant lenses block 99.9% of UV rays

Meets the requirements of ANSI Z87.1, CSA Z94.3 and AS/NZS 1337

Gray lenses help reduce sunlight and are popular for outdoor use

Mirrored lenses help reduce glare and are popular for indoor/outdoor use

Typical properties

ANSI Requirements

ANSI Z87.1-2010

Anti Fog Lens

Yes

Brands

SecureFit™

Catalog Number

SF400G-WV-6-PS

Factory ISO Certification

No ISO Certification information available

Frame Color

Neon Green/Black

Frame Material

Polycarbonate

Frame Style

W

Dimensions and Classifications

Overall Height (Imperial)

10.05 in

Overall Height (Metric)

255.27 mm

Overall Length (Imperial)

5 in

Overall Length (Metric)

127 mm

Overall Width (Imperial)

6.9 in

Overall Width (Metric)
175.26 mm

3M™ Comfort Grip Gloves - General Use

Details

Excellent dexterity and grip, even in wet or oily conditions
Typical applications include general material handling; handling small parts;
electrical component assembly; carpentry, plumbing and roofing
EN388 4122
Long-lasting, durable and washable

Typical properties

EN 388 Mechanical Risk Designations
4122
Material
Nylon
Product Color
Gray
Product Type
General Use Work Glove
Size
Large, Medium, X-Large
Units per Case
6.0
eClass 14 Classification Group
40280203

3M™ Versaflo™ Vortex Spare Parts Kit V-115 1 EA/Case

3M Product Number V-115 3M ID 7000126274 UPC 00051138661618

Details

Kit has the necessary items to maintain the 3M™ Vortex Cooling Assembly V-100

Typical properties

Brands

Versaflo™

CFM Capacity per Minute

100 CFM, 50 CFM

Case Quantity

1/pack

Compatible With

3M™ Valve Assembly V-100

Pressure Type

High

Product Color

Black, White

Product Series

Fresh-Air III, Supplied Air, V-Series

Product Type

Spare Par

3M™ Tie-Back Double Locking Snap Hook 9501804, Zinc Plated Steel, 5000 lb Gate, 0.82 in. Throat

3M Product Number 9501804 3M ID 7012821224

Details

- Corrosion resistant plated steel hardware
- High strength construction with 3,600 lb (16kN) rated gate
- Double action and locking gate for added safety
- Compact design
- Designed to allow horizontal movement along the anchorage, but does not include capability to pass intersecting structures
- Compatible with various fall arrest systems
- Recommended for use in multiple industries including construction, oil and gas, and utilities
- Meets the requirements for 29 CFR OSHA 1910.140, 29 CFR OSHA 1926.502

Typical properties

- Attachment Type
 - Hook, None
- Brands
 - DBI-SALA®
- Carabiner/Hook Material
 - Zinc Plated Steel
- Case Quantity
 - 1
- Connected Safety ID Equipped
 - No
- Dimensions
 - 110.00x73.00xmm
- Install Type
 - None, Reusable
- Product Type
 - Double action snap hook
- Recommended I

3M™ DBI-SALA® Flexiguard™ Jib Counterweight Base Stabilizing Jack Kit 8530563, Yellow

Part Number 8530563 3M Product Number 8530563 3M ID 7100231983

Details

Counterweighted overhead rail fall protection system
Aluminum and steel construction
Complete hardware provided
Portable with use of a forklift
Includes four steel leveling jacks; built-in slope indicators available as option
Recommended for a variety of applications within the transportation, construction, utilities, and mining industries
Available in multiple sizes, both fixed and adjustable heights
One part of your fall protection system; intended for use with other personal protective equipment (PPE) including (but not limited to) harnesses and self-retracting lifelines
Specialized installation and training available

Typical properties

Brands
FlexiGuard™
Case Quantity
1
Connected Safety ID Equipped
No
Dimensions
(12.50x8.00x9.50)in
Install Type
Permanent
Maximum Number of Users
One
Product Color
Yellow Zinc
Product Series
FlexiGuard™
Product Type
Counterweight Base Jack

3M™ DBI-SALA® Metal Horizontal Lifeline Energy Absorber with Hardware Kit 7401033, 3 Shackles, Turnbuckle, Cable Clips

Part Number 7401033 3M Product Number 7401033 3M ID 7012798862

Details

For use with horizontal lifeline system
Metal energy absorber limits fall arrest forces
Durable, lightweight and portable design
Configure up to 60 ft. (18.3m) length system with one device or 100 ft. (30.5m) with two
Lightweight and portable design
Extremely durable construction
Mounting kit includes 3 shackles and fasteners

Typical properties

Brands
DBI-SALA®
Case Quantity
1
Connected Safety ID Equipped
No
Install Type
Temporary/Portable
Lifeline Material
Order separately
Maximum Number of Workers
2
Product Type
Energy Absorber Kit
Recommended Industry
Construction, General Indu

3M™ DBI-SALA® Metal Horizontal Lifeline Energy Absorber with Hardware Kit 7401031, 2 Shackles

Part Number 7401031 3M Product Number 7401031 3M ID 7012820255

Details

For use with horizontal lifeline system
Metal energy absorber limits fall arrest forces
Durable, lightweight and portable design
Configure up to 60 ft. (18.3m) length system with one device or 100 ft. (30.5m) with two
Lightweight and portable design
Extremely durable construction
Mounting kit includes 3 shackles and fasteners

Typical properties

Brands
DBI-SALA®
Case Quantity
1
Connected Safety ID Equipped
No
Install Type
Temporary/Portable
Lifeline Material
Order separately
Maximum Number of Workers
2
Product Type
Energy Absorber Kit
Recommended Industry
Construction, General Indu

3M™ PELTOR™ Hygiene Kit for Worktunes Headset HY220, 1 EA/Bag

3M ID 7100101874 UPC 04054596206311

Typical properties

Brands
PELTOR™
Product Type
Hygiene Kit
eClass 14 Classification Group
40270191

3M™ PELTOR™ Earmuff Hygiene Kit HY68, Green Earseals, 1 kt/cs

3M Product Number HY68 SV 3M ID 7000039647 UPC 07318640025615

Details

Replacement ear cushions and foam liners for the 3M™ PELTOR™ COMTAC™ and SoundTrap Headsets

Includes two green ear cushions and two foam inserts

Replace at least twice a year to ensure constant attenuation, hygiene and comfort

Typical properties

Brands

PELTOR™

CSA Class

AL

Compatible Earmuff

ComTac Series, SoundTrap

Hearing Protection Style

Hygiene Kit

Hearing Protection Type

Spare Part

Product Color

Black, Green

Product Type

Hygiene Kit

Recommended Application

Agriculture

Recomme

3M™ Scott™ AV-3000 HT Facepiece

3M ID B5005218022

Details

Approved with the Air-Pak X3 Pro SCBA, compliant to the NFPA 1981 Standard on Open-Circuit Self-Contained Breathing Apparatus for Emergency Services, 2018 Edition

Approved with Air-Pak SCBA models compliant to the 2013 edition, 2007 edition and 2002 edition of NFPA 1982

State-of-the-art materials and design for enhanced performance

Proven SureSeal face seal for excellent fit and comfort

ANSI Z87.1-2010 impact rated Z87+

Available in 3 sizes with either a 4 strap or 5 strap Kevlar® head harness

Compatible with EPIC 3 Communication Systems

Right and left communication installation options

Top Down Convertibility - Single facepiece is approved across range of respirators from the lowest to highest level of protection (APR, SAR, PAPR and SCBA)

Compatible with award-winning 3M Scott Sight In-Mask Thermal Imager

Versatility of facepiece helps lower cost of ownership through reduced fit testing, simplified training and reduced inventory requirements

Easy to maintain. facepiece with no exhalation valve to clean or manipulate

Fully open front port enables easy communication and breathing without any obstruction when in stand-by mode

Typical properties

Brands

Scott™

Connection Type

Quarter Turn

eClass 14 Classification Group

40220113

3M™ Scott™ Weld-O-Vista Facepiece

3M ID B5005047155

Details

Approved with 3M Scott NIOSH respirators including SCBA, Supplied Air, and APR

Range of APR cartridges, either twin 742 series or single 40mm series for respiratory protection across a wide range of hazards

Incorporates a standard 2" x 4 1/4" welding filter (not included)

Available with Kevlar® head harness

Typical properties

Brands

Scott™

Compatible Respirator

Scott NIOSH Breathing Apparatus

Side Windows

No

Viewing Area (Imperial)

2 in x 4.25 in

Viewing Area (Metric)

50 mm x 108 mm

3M™ Speedglas™ Duct Assembly 26-0400-55, 1 EA/Case

3M Product Number 26-0400-55 3M ID 7000128095 UPC 00051131497245

Details

Duct Assembly
Replacement Part

Typical properties

Brands

Speedglas™

Case Quantity

1

Compatible Welding Helmet

9100 FX-Air Welding Helmets

Features

Respiratory Accessory

For Use With

3M™ Speedglas™ 9100FX-Air Welding Helmets

Product Color

Black

Product Series

9100 FX-Air

Product Type

Air Du

3M™ Speedglas™ Air Duct Tube 25-0400-55, 1 EA/Case

3M Product Number 25-0400-55 3M ID 7000128107 UPC 00051131498358

Details

Air Duct Tube
Replacement Part

Typical properties

Brands

Speedglas™

Case Quantity

1

Compatible Welding Helmet

9100 FX-Air Welding Helmets

Features

Respiratory Accessory

For Use With

3M™ Speedglas™ Welding Helmet 9100 Air

Part Type

Spare Part

Product Color

Black

Product Series

9100, 9100-Ai

3M™ DBI-SALA® FlexiGuard™ M200 Semi-Fixed Height Mast

Details

- Powder coated steel upright and gusset components
- Extended rail-length increases safe working area compared to our previous jib systems
- Extended anchor height enhances capabilities in various applications compared to our previous jib systems
- Automatic mast lock helps prevents uncontrolled mast movement
- Aluminum extruded trolley rail
- Rotating mast up to 360 degrees with flip up rotation handle
- Permanent or portable mounted designs available
- Stainless steel / nylon construction
- Power assisted height adjustment capability for adjustable models
- Integrated level indicators (Counterweight Bases). Removable counterweight box (Counterweight Bases) with built in fork pockets and lifting ring attachment points (Lifting Kit sold separately). Open multi-directional base designed to accommodate a wide array of fork shapes and sizes
- 3M™ Safety-Walk™ Slip Resistant walking surface (counterweight Bases)
- Additional system mobility with optional caster wheel kit

Typical properties

- Connected Safety ID Equipped
- No
- Install Type
- Temporary/Portable
- Manufacturing Origin
- USA
- Maximum Height (Imperial)
- 20 ft, 25 ft, 30 ft
- Maximum Height (Metric)
- 6.1 m, 7.6 m, 9.1 m
- Maximum Number of Users
- One, Two
- Minimum Height (Imperial)
- 15 f

Dimensions and Classifications

- Overall Height (Metric)
- 0 mm, 430 mm
- Overall Length (Metric)
- 0 mm, 6150 mm, 7920 mm
- Overall Width (Metric)
- 0 mm, 102 mm, 122 mm

3M™ Scott™ Monitor Telemetry Software Solution

3M ID B5005270004

Details

Works with all 3M Scott Air-Pak SCBA equipped with SEMS II and SEMS II Pro
Automatic acceptance of devices at base station helps to ensure devices are monitored from the moment they connect to the base station
Alert view helps to provide immediate recognition of critical SCBA alerts for incident command
Touch-friendly interface for enhanced usability
Compatible with Windows 7 OS (and higher)

Typical properties

Brands
Scott™
Product Type
Monitoring Software
eClass 14 Classification Group
13030200

3M™ GoggleGear™ 6000 Series Safety Goggles

Details

Indirect venting allows air to circulate and helps reduce fogging

D3 (droplet and splash) and D4 (dust) rated

Polycarbonate lens absorbs 99.9% UVA & UVB and meet the requirements of ANSI Z87.1- 2015 Standard as an Impact Rated spectacle

Typical properties

Anti Fog Lens

Yes

Brands

GoggleGear™

Case Quantity

10

Class

Premium

Comfort Features

Adjustable elastic strap, Indirect ventilation, Neoprene Strap, Nylon,

Polycarbonate lens, Soft rubber seal

Frame Color

Black/Black, Black/Green, Gray/Blue

Fr

3M™ PELTOR™ Replacement Clip PIC-100CL, 20 ea/Case

3M Product Number PIC-100CL 3M ID 7100262875 UPC 00638060433119

Details

Replacement clip for the PIC-100 NA
Easy to replace
No tools necessary

Typical properties

Brands
PELTOR™
Case Quantity
20
Compatible With
PIC-100 Communication Headset
Product Type
Battery Clip
eClass 14 Classification Group
40270191

3M™ Speedglas™ G5 Scrape Guard 46-0700-82, 3 EA/Case

3M Product Number 46-0700-82 3M ID 7100311871

Details

Scrape protection

Typical properties

Brands
Speedglas™
Compatible Welding Helmet
G5-01 Welding Helmets, G5-03 Series
Part Type
Accessory
Product Series
G5
Product Type
Headcovers
eClass 14 Classification Group
40300190

3M™ E-A-R™ E-A-R Caps™ Model 200 Hearing Protector Replacement Pods 321-2103, 10 EA/Case

Part Number 19066 3M Product Number 321-2103 3M ID 7000127665

Details

Replacement foam caps for E-A-R Caps Model 200 Hearing Protector 350-2100 and 321-2101

Soft foam replacement caps for use only with E-A-R caps banded hearing protector. Not for use without band

Noise Reduction Rating (NRR)*: 17 dB with the E-A-R caps™

*The NRR may overestimate the hearing protection provided during typical use

Typical properties

Attenuation Rating

17.0 Decibel

Banded

No

Brands

E-A-R™

CSA Class

CSA Class BL

Case Quantity

50

Corded

No

Dielectric

No

Earplug Material

Foam

Earplug Shape

Round

Earplug Size

Regular

Hearing Protection Style

Push-to-fit

Insertion Sty

3M™ PELTOR™ ComTac™ VII Headset

Details

Wireless connection to the 3M™ PELTOR™ system control unit, SCU-300 (not included). Go cord free, with 3M's NFMI enabled wireless – reduced cable management, and snag-free operations

Natural Interaction Behavior (NIB): short-range, headset-to-headset communication without the use of an external communications

Mission Audio Profiles (MAP): advanced ambient listening modes that allow access to a variety of gain settings, but with frequency shaping, to help enhance situational awareness

New Headband Design. A complete redesign helps improve comfort when worn under a ballistic helmet

Transition made simpler. Simplified cable removal and resetting and redesigned arm guides that snap on/off (no tools required) for easy transition between Accessory Rail Connectors (ARC) and headband

Speech Microphone. Redesigned and embedded with patented 3M closed cell foam, delivers improved noise cancelling transmission in high noise and wind while also improving dust and water ingress protection (IP68, 6m / 30 min)

Optional Wired Cable Connection. A port for an optional wired connection to the 3M™ PELTOR™ System Control Unit (SCU-300) , as primary or back-up connection

New Battery Compartment. Redesigned, watertight battery compartment that does not require a tool to change batteries

New Microphone Attachment. Designed to help accommodate both left handed and right handed shooters without the need to relocate the microphone to opposite side of the headset

New Environmental Mic Design. The new profile of the ear cup widens and deepens the location of the upgraded microphones with a robust wind screen

Typical properties

Attenuation Rating
23 dB

Audio Type
Communication

Battery Life
Approx. 30 hours (Environmental Listening & NIB), Approx. 50 hours (Environmental Listening)

Case Quantity
10 ea/cs

Communication Type
2-Way

Connection Type
Wireless

Features
Leve

3M™ E-A-R™ Classic™ Probed Test Plugs 393-2003-50, 50 EA/Case

3M Product Number 393-2003-50 3M ID 7000052882 UPC 10080529190762

Details

These test earplugs are modified with a probe tube for use during earplug fit testing with the 3M™ E-A-Rfit™ Validation System

50 PR Per Case

3M PSD products are for occupational use only

*The NRR may overestimate the hearing protection provided during typical use

Typical properties

Brands

E-A-R™

Case Quantity

50

Earplug Shape

Cylinder

Material

PVC

Product Color

Yellow

Product Series

E-A-Rfit

Product Type

Probed Test Earplug

Recommended Application

Health & Safety Testing

eClass 14 Classification Group

40270102

3M™ E-A-R™ Classic™ Probed Test Plugs 393-2007-50, Small Size, 50 EA/Case

3M Product Number 393-2007-50 3M ID 7000052884 UPC 10080529190809

Details

These test earplugs are modified with a probe tube for use during earplug fit testing with the 3M™ E-A-Rfit™ Validation System

50 PR Per Case

3M PSD products are for occupational use only

*The NRR may overestimate the hearing protection provided during typical use

Typical properties

Brands

E-A-R™

Case Quantity

50

Earplug Shape

Cylinder

Material

PVC

Product Color

Yellow

Product Series

E-A-Rfit

Product Type

Probed Test Earplug

Recommended Application

Health & Safety Testing

Recommended Industry

Commercial Buildings, De

3M™ Speedglas™ G5-01 Outer Welding Visor Frame, 46-0700-63, 1 EA/Case

3M Product Number 46-0700-63 3M ID 7100214395 UPC 00076308944636

Details

Replacement spare part covering the outside protection plate
Replace worn out or damaged parts
For maximum safety and comfort, make it a habit to check your equipment regularly

Typical properties

Brands
Speedglas™
Compatible Welding Helmet
G5-01 Welding Helmets
Product Color
Black
Product Series
G5
Product Type
Visor Frame
Recommended Application
Grinding, Metal Processing, Metal Repair, Welding
Recommended Industry
General Manufactur

3M™ PELTOR™ CH-3 Headset with PTT Neckband MT74H52B-111, FLX2, 10 ea/Case

3M Product Number MT74H52B-111 3M ID 7100205729 UPC 04054596695726

Details

Protective communication solution for hands-free, clear communication in noisy environments

FLX2 connection jack for easy and reliable connection to a wide assortment of handheld devices

Lasting comfort for long duration wear times

Designed to withstand harsh environmental elements

Water and dust-proof noise-cancelling microphone (IP68) for clear speech transmission in noisy and harsh environments

Audio speakers are optimized for speech frequencies and meet the efficiency demands of many of today's digital devices

A Push-To-Talk button is conveniently located on the earcup for easy access

Bright yellow color for enhanced visibility

Flexible yet sturdy neckband design adapts to a wide variety of head shapes and sizes, and can be worn with most hard hats

Typical properties

Attenuation Rating

24 dB

Audio Type

Communication

Auxiliary Port

FLX2

Brands

PELTOR™

CSA Class

CSA Class A

Case Quantity

1

Communication Direction

Two-way

Communication Type

External Audio Input

Communication via External 2-Way Radio

Yes

3M™ Versaflo™ TR-600 Series PAPR Systems

Details

Respiratory protection against dusts, mists, fumes and other particulate hazards, and a variety of gas and vapor hazards, including organic vapor and acid gas
Three user selectable airflows with loose-fitting and tight-fitting options, enable the user to control flow settings to allow the user to find the setting they find most comfortable

Blowers automatically adjust airflow to compensate for filter loading to deliver consistent filtered air during use

Audible, visual, and vibratory alerts for low airflow and low battery charge-level to keep you prepared and informed

High capacity battery option available for longer run time and reduced downtime

Available in convenient, easy to buy assemblies and kits

Typical properties

Assigned Protection Factor

25

Battery Life

4 - 12 Hours, 5.5 to 13 hours, 8 hr, 8 hr - 19 hr

Battery Type

High Capacity Lithium Ion - Rechargeable, None, Standard Capacity Lithium Ion - Rechargeable

Belt Type

Easy Clean, High Durability, None

Bran

FUTURO™ Trouser Socks for Women, Moderate Compression

3M ID CBGBLW011022 UPC 00051131215924

Details

Moderate Compression (15-20 mm/Hg)
Helps relieve symptoms of swelling, mild spider and varicose veins
Ideal for standing or sitting all day, traveling or active office work
Graduated compression helps improve circulation
Great for business casual or weekend wear
Made with a fashionable diamond pattern
Built-in heel and toe comfort pockets help prevent scrunching
Made from a comfortable blend of nylon and spandex
Size: M, L
Color: Black

Typical properties

Body Part
Leg
Brands
FUTURO™
Compression Level
Moderate
Condition
Achy or Tired Legs, Mild Varicose Veins or Swelling
Factory ISO Certification
No ISO Certification information available
Material
Nylon, Spandex
Product Color
Black
Product Ty

3M™ Vented Pro Ratchet Hard Hat

3M ID CBGNAW011084 UPC 10078371625709

Details

Ratchet adjustment for custom, on-head sizing
Three levels of height adjustment promote optimal comfort
Ventilation ports enhance airflow
Suspension system sits lower on your head to reduce pressure points
Low-profile design enhances stability for balanced comfort
Short brim is great for upward visibility
Breathable foam brow pad enhances comfort
Compliant with ANSI/ISEA requirements when worn in forward and back-facing positions
Meets the requirements of ANSI/ISEA Z89.1 Type 1, Class C
Meets the requirements of CSA Z94.1 Type 1, Class C
Clean your hard hat with mild soap and water
For product questions, call 3M Product Application Support team at 1-800-494-3552

Typical properties

Electrical Class
C, E, G
Factory ISO Certification
No ISO Certification information available
Hard Hat Type
Type I
Product Type
Front Brim Hard Hat
Shell Material
HDPE
Specifications Met
ANSI Z89.1-2003
Suspension Type
4 Point Ratchet
Sweatband

Dimensions and Classifications

Overall Height (Imperial)
7 in
Overall Height (Metric)
17.78 cm
Overall Length (Imperial)
11 in
Overall Length (Metric)
27.94 cm
Overall Width (Imperial)
8.5 in
Overall Width (Metric)

3M™ Full-Brim Non-Vented Hard Hat with Ratchet Adjustment, CHH-FB-R-W6-PS, 6/case

3M ID 70006963220 UPC 00078371912802

Details

Ratchet adjustment for custom, on-head sizing
Full-brimmed hard hat style helps shade your skin from the sun
Three levels of height adjustment promote optimal comfort
Suspension system sits lower on your head to reduce pressure points
Low-profile design enhances stability for balanced comfort
Breathable foam brow pad enhances comfort
Meets the requirements of ANSI/ISEA Z89.1 Type 1, Class G and E
Meets the requirements of CSA Z94.1 Type 1, Class G and E
Clean your hard hat with mild soap and water
Part of our Pro Series for exceptional performance
For product questions, call 3M Product Application Support team at 1-800-494-3552
For product questions, call 3M Product Application Support team at 1-800-494-3552

Typical properties

Brands
3M™
Electrical Class
C, E, G
Factory ISO Certification
No ISO Certification information available
Hard Hat Type
Type I
Product Type
Full Brim Hard Hat
Shell Material
HDPE
Specifications Met
ANSI Z89.1-2003
Suspension Type
4 Point Rat

Dimensions and Classifications

Overall Height (Imperial)
7 in
Overall Height (Metric)
17.78 cm
Overall Length (Imperial)
11 in
Overall Length (Metric)
27.94 cm
Overall Width (Imperial)

8.5 in
Overall Width (Metric)
21.59 cm

3M™ Particulate Respirator 8200

3M ID CBGNAW011148 UPC 00051141904832

Details

NIOSH-APPROVED N95 for at least 95 percent filtration efficiency against certain non-oil-based particles and aerosols
ADVANCED FILTER MEDIA for easy breathing
CUSHIONING NOSE FOAM rests on bridge of nose for comfort
ADJUSTABLE NOSECLIP helps ensure a custom, secure seal
STRETCHABLE STRAPS
LIGHTWEIGHT DESIGN for comfort
CONVENIENT, DISPOSABLE DESIGN
RECOMMENDED FOR use when sanding, sawing, grinding, lawn mowing, sweeping, drywall sanding, grinding, woodworking and working with fiberglass insulating particles
ALSO HELPS PROTECT AGAINST: certain particles such as mold, granular pesticides, allergens and dust
Contains no components made from natural rubber latex
Available in multiple package quantities
DIY/Home Use: Use ONLY in NON-HARMFUL environments.
Occupational/Hazardous Use: Use under a government regulated (e.g. OSHA) respiratory protection program. WARNING: Limitations apply; Misuse may result in sickness or death. See product packaging and insert or call 3M in USA at 1-800-243-4630. In Canada, call 1-800-267-4414

Typical properties

Cool Flow™ Exhalation Valve
No
Enhanced Comfort
No
Enhanced Durability
No
Exhalation Valve
No
Faceseal
Yes
Factory ISO Certification
No ISO Certification information available
Filter Class
N95, P95
Hazard Type
Fiberglass, Sanding
Noseclip

3M™ Hi-Viz Construction Vest Orange

3M ID CBGNAW011211 UPC 00078371946258

Details

3M™ Scotchlite™ reflective material safety vests
3M™ Scotchlite™ Reflective material for 360° visibility and protection
Lightweight mesh for air circulation and faster drying times
Five-point tear-away design
One size fits most
Adjustable side straps
Two large interior pockets
Designed for moderate risk: construction, utility, school crossing, parking lots, traffic direction
Meets ANSI/ISEA 107-2010 Class 2 and Federal Highway Mandate - 2009 Manual of Uniform and Traffic Control Devices

Typical properties

ANSI Class Level
Class 2
Factory ISO Certification
No ISO Certification information available
Flame Resistance (ASTM D2859-96)
No
Garment Hood
No
Garment Lined
No
Garment Reversible
No
Material
Polyester
Product Type
High Visibility
Size

Dimensions and Classifications

Overall Height (Imperial)
8.2 in
Overall Height (Metric)
20.8 cm
Overall Length (Imperial)
7.4 in
Overall Length (Metric)
18.8 cm
Overall Width (Imperial)
1 in
Overall Width (Metric)

2.54 cm

Peltor™ Sport Tactical 100 Electronic Hearing Protector, TAC100-OTH, 4/CV

3M ID 70006924933 UPC 00051141394237

Details

NRR: 22 dB noise reduction rating
IDEAL FOR both indoor and outdoor shooters and hunters
VARIABLE SUPPRESSION TIME reduces echoes indoors
ADAPTIVE FREQUENCY RESPONSE reduces background noise for clearer conversation and hearing of commands
DURABLE RECESSED MICROPHONES prevent damage and reduce wind noise
ADJUSTABLE HEADBAND added padding for a comfortable fit
RUNS ON 2 AAA BATTERIES

Typical properties

Audio Type
Communication
Battery Type
Disposable AAA
Brands
PELTOR™
Catalog Number
TAC100-OTH
Factory ISO Certification
No ISO Certification information available
Suspension Method
Headband
eClass 14 Classification Group
40270191

3M™ SecureFit™ 400 Eye Protection SF400C-WV-6-PS Clear Anti-Fog, 6ea/cs

3M ID 70006963386 UPC 00076308723941

Details

Durable lenses help provide limited protection from light to moderate impact hazards

3M™ Pressure Diffusion Temple self-adjusts to provide a secure, comfortable fit

Padded temples for added comfort over the ears

Soft, conformable nose pads provide customizable comfort

Lightweight, durable design for all-day comfort and lasting wear

Flexible temples conform comfortably to different head sizes

Flexible temples conform comfortably to different head sizes

Anti-fog, scratch-resistant lenses help keep vision clear

Impact-resistant lenses block 99.9% of UV rays

Meets the requirements of ANSI Z87.1, CSA Z94.3 and AS/NZS 1337

Clear lenses help provide excellent visibility and can be used indoors or outdoors

Mirrored lenses help reduce glare and are popular for indoor/outdoor use

Typical properties

ANSI Requirements

ANSI Z87.1-2010

Anti Fog Lens

Yes

Brands

SecureFit™

Catalog Number

SF400C-WV-6-PS

Factory ISO Certification

No ISO Certification information available

Frame Color

Neon Green/Black

Frame Material

Polycarbonate

Frame Style

W

Dimensions and Classifications

Overall Height (Imperial)

10.05 in

Overall Height (Metric)

255.27 mm

Overall Length (Imperial)

5 in

Overall Length (Metric)

127 mm

Overall Width (Imperial)

6.9 in

Overall Width (Metric)
175.26 mm

3M™ Paint Project Respirator with Quick Latch 6502QLPA1-A-PS, Size Medium, 1 Ea/Pk,4 Pks/Cs

3M ID 70006963089 UPC 00076308729974

Details

NIOSH-APPROVED 6001 OV CARTRIDGE for use against certain organic vapors
NIOSH-APPROVED 5P71 P95 RATED filters for at least 95% filtration efficiency against solids and liquid aerosols, as well as oil-based particulates
REUSABLE 501 RETAINER attaches filter to cartridge
FOR WORKPLACE/OCCUPATIONAL USE ONLY
OIL PROOF P-series particulate filter (Use according to manufacturer's time use restrictions when oil aerosols are present)
QUICK LATCH SYSTEM easy, one handed- on/off and makes it easy to drop respirator down from face without removing straps in a non-contaminated area
ADJUSTABLE HEAD STRAPS allow for a personalized fit
VALVE COVER DESIGN directs exhaled breathe and moisture downward
CONVENIENT, REUSABLE DESIGN
DURABLE DESIGN for lasting wear
LIGHTWEIGHT, SILICONE FACESEAL for premium comfort
6001 OV CARTRIDGE HELPS REDUCE EXPOSURE to certain organic vapors encountered during activities involving latex and oil-based painting, including paint spraying*, varnishes, stains, sealants, solvents, certain solvent-based cleaners or pesticides**. *Use a prefilter when spraying **Refer to Pesticide Product Label for Respirator Guidance or call 3M at 1-800-243-4630 or In Canada, call 1-800-267-4414
5P71 FILTER HELPS REDUCE EXPOSURE to certain particles from paint spraying*, spray adhesives and pesticides**. *Use a prefilter when spraying **Refer to Pesticide Product Label for Respirator Guidance or call 3M at 1-800-243-4630 or In Canada, call 1-800-267-4414
3M™ BAYONET CONNECTION compatible with 3M™ cartridges and filters
KIT CONTENTS: one facepiece, one pair of replaceable 6001 Organic Vapor cartridges, one pair of 501 retainers and two pairs of replaceable 5P71 particle filters

Typical properties

Application Type
Paint Project
Brands
3M™
Cartridge or Filter Included
Yes
Cartridge or Filter Type
Gas & Vapor
Catalog Number
6502QLPA1-A-PS
Clip-on Welding Shield

No
Compatible with 3M™ PAPR Systems
No
Compatible with 3M™ Supplied Air Syst

Dimensions and Classifications

Overall Height (Imperial)
9.6 in
Overall Height (Metric)
24.384 cm
Overall Length (Imperial)
5.5 in
Overall Length (Metric)
13.97 cm
Overall Width (Imperial)
10 in
Overall Width (Metric)
25.4 cm

FUTURO™ Performance Compression Knee Sleeve

3M ID CBGBLRUS1492 UPC 00051131204911

Details

Provides all over, even compression to areas covered by the sleeve
Provides compression for sore muscles
Four-way stretch fabric and ergonomic construction enable a wide range of motion
Low-profile, breathable fabric helps keep air flowing
Great for everyday use, travel and during athletic activities
Simply hand wash with mild soap and air dry
Supported by our expert panel of engineers and medical professionals
Includes one compression sleeve
Size: S/M, L/XL

Typical properties

Body Part
Knee
Brands
FUTURO™
Factory ISO Certification
No ISO Certification information available
Fit Range
S/M fits: 12" to 14.5"
L/XL fits: 14.5" to 17"
Foot Style
Closed Toe
Material
Polyester, Spandex
Product Color
Gray
Product Type

ACE™ Brand Sports Compression Knee Sleeve

3M ID CBGBLRUS1526 UPC 00051131194113

Details

Stretchable fabric and anatomical design conforms to your knee for comfort, fit and compression

Breathable material for cooling comfort

Flexible design allows for full range of motion

Ideal for stiff, weak and injured knees

Fits left or right knee

Size: S/M, L/XL

#1 Pharmacist Recommended Brand of Braces & Supports* (*Based on

Pharmacy Times and U.S. News & World Report 2020-2021 National Survey)

Supported by our expert panel of engineers and medical professionals

Typical properties

Body Part

Knee

Brands

ACE™

Factory ISO Certification

No ISO Certification information available

Fit Range

S/M fits 12" to 14.5",L/XL fits: 14.5" to 17"

Foot Style

Closed Toe

Product Type

Support

Size

Large/X-Large, Small/Medium

Sizes Availab

3M™ Powerflow™ PAPR Systems

Details

US OSHA APF 1000 when used in accordance with 3M recommendations and user instructions
Economically priced
Compact design fits closely to the wearer

Typical properties

Battery Life
8 hr
Battery Type
NiCd - Rechargeable
Belt Type
None
Breathing Tube Type
Front-Mounted Combination
Cartridge or Filter Included
No
Case Quantity
1
Facepiece Type
Full Facepiece
Hazard Type
Mold, Silica
Headgear Type
Full Face

3M™ Exhalation Valve Filter 604, 30 ea/Case

Part Number 604 3M Product Number 604 3M ID 7100245392

Details

NIOSH approved accessory for 3M™ Reusable Respirator Half Facepiece 6000 Series with 3M™ Particulate Filters 7093, 5N11/501/603 or 2091
Designed to help filter the wearer's exhaled breath
Provides source control when worn with 3M 6000 Series Half Facepiece Reusable Respirators
EVF filter media meets 99% Bacterial Filtration Efficiency (BFE) based on testing conducted per ASTM F2101. Not FDA cleared as a medical device
EVF is fluid resistant based on testing conducted per ASTM F1862. Not FDA cleared as a medical device
Can be safely wiped with water, cleaners, and disinfectants between uses
Designed to maintain the breathing comfort provided by an exhalation valve
Allows users to conduct a positive pressure seal check while installed on facepiece

Typical properties

Accessories
No
Brands
3M™
Cartridge or Filter Included
No
Clip-on Welding Shield
No
Compatible Respirator
6000 Series
Compatible with 3M™ PAPR Systems
No
Compatible with 3M™ Supplied Air System
No
Compatible with Welding Shield
No
Connecti

Dimensions and Classifications

Overall Height (Imperial)
3 in
Overall Height (Metric)
7 cm
Overall Length (Imperial)
3 in
Overall Length (Metric)
7 cm
Overall Width (Imperial)
1.2 in

Overall Width (Metric)
2.8 cm

3M™ DBI-SALA® FlexiGuard™ M100 Semi-Fixed Height Mast

Details

- Powder coated steel upright and gusset components
- Extended rail-length increases safe working area compared to our previous jib systems
- Extended anchor height enhances capabilities in various applications compared to our previous jib systems
- Automatic mast lock helps prevent uncontrolled mast movement
- Aluminum extruded trolley rail with stainless steel / nylon trolley construction
- Rotating mast up to 360 degrees with Flip up rotation handle
- Permanent and portable mounted designs available
- Power assisted height adjustment capability for adjustable models
- Leveling jacks standard on the M100 with integrated fork pockets for transporting and positioning using industrial forklifts
- 3M™ Safety-Walk™ Slip Resistant walking surface (counterweight Bases)
- Additional system mobility with optional caster wheel kit

Typical properties

- Connected Safety ID Equipped
- No
- Install Type
- Temporary/Portable
- Manufacturing Origin
- USA
- Maximum Height (Imperial)
- 20 ft, 25 ft, 30 ft
- Maximum Height (Metric)
- 6 m, 8 m, 9 m
- Maximum Number of Users
- One
- Minimum Height (Imperial)
- 15 ft, 20 ft, 2

Dimensions and Classifications

- Overall Height (Metric)
- 0 mm, 1000 mm
- Overall Length (Metric)
- 0 mm, 6200 mm
- Overall Width (Metric)
- 0 mm, 144 mm

3M™ DBI-SALA® Flexiguard™ M100 Modular Jib Rescue Mount and Pulley Kit 8530905, Black

3M Product Number 8530905 3M ID 7012820972

Details

Enables a rescue device to be mounted to the system
Includes mounting brackets
Includes re-direct pulleys

Typical properties

Brands
DBI-SALA®
Connected Safety ID Equipped
No
Install Type
Temporary/Portable
Maximum Number of Users
One or Two
Net Weight (Imperial)
40 lb
Net Weight (Metric)
18.14 kg
Product Series
FlexiGuard™, M200
Product Type
Modular Jib Accessory

3M™ Secure Click™ Particulate Filter P95 with Nuisance Level Organic Vapor/Acid Gas Relief D3078, 100 ea/Case

3M Product Number D3078 3M ID 7100213435 UPC 50051131278139

Details

Secure Click™ connection style enables a quick, simple connection of filters
Secure Click™ filters are dual-flow to allow easier breathing and greater comfort
Use with NIOSH-approved 3M™ Secure Click™ facepieces
Advanced Electret Media (AEM) provides lightweight, easy breathing comfort
NIOSH-approved P95 particulate filter for respiratory protection against certain oil and non-oil based particulates
Recommended for ozone protection up to 10x the OSHA PEL
Nuisance level organic vapor/acid gas relief
Swept-back design for enhanced field of view and comfort
For workplace/occupational use only
Package contents: 1 case contains 50 pairs of filters (100 each)

Typical properties

Accessories

No

Brands

Secure Click™

Cartridge or Filter Type

Particulate

Clip-on Welding Shield

No

Compatible Respirator

3M™ Secure Click™ Half Facepiece Reusable Respirators HF-800 Series

Compatible with 3M™ PAPR Systems

No

Compatible with 3M

Dimensions and Classifications

Overall Height (Metric)

25 mm

Overall Length (Metric)

120 mm

Overall Width (Metric)

105 mm

3M™ Secure Click™ Particulate Cartridge P95/Hydrogen Fluoride w/ Nuisance Acid Gas Relief D3076HF, 100 ea/Case

3M Product Number D3076HF 3M ID 7100213424 UPC 50051131278122

Details

Secure Click™ connection style enables a quick, simple connection of filters
Secure Click™ filters are dual-flow to allow easier breathing and greater comfort
Use with NIOSH-approved 3M™ Secure Click™ facepieces
Advanced Electret Media (AEM) provides lightweight, easy breathing comfort
NIOSH-approved P95 particulate filter for respiratory protection against certain oil and non-oil based particulates
NIOSH-approved to help protect against hydrogen fluoride gas
Nuisance level acid gas relief
Swept-back design for enhanced field of view
For workplace/occupational use only
Package contents: 1 case contains 50 pairs of particulate cartridges (100 each)

Typical properties

Accessories

No

Brands

Secure Click™

Cartridge or Filter Type

Particulate

Clip-on Welding Shield

No

Compatible Respirator

3M™ Secure Click™ Half Facepiece Reusable Respirators HF-800 Series

Compatible with 3M™ PAPR Systems

No

Compatible with 3M

Dimensions and Classifications

Overall Height (Metric)

25 mm

Overall Length (Metric)

120 mm

Overall Width (Metric)

105 mm

3M™ Secure Click™ Hard Case P100 Particulate Filter D9093B, 144 ea/Case

3M Product Number D9093B 3M ID 7100206895 UPC 50689330191555

Details

- 99.97% filter efficiency meets NIOSH P100 test criteria
- Use with 3M™ Secure Click™ Respirators
- Hard case recommended for harsh environments with a need for easy decontamination and protection
- Hard case helps protect against sparks and high heat
- Filter case designed for certain spray applications
- Secure Click™ connection allows filters to be inserted into place for ease of assembly
- Solid top and channeled airflow help protect filter
- Swept-back design provides wide field of view

Typical properties

- Accessories
No
- Brands
Secure Click™
- Cartridge or Filter Type
Particulate
- Compatible Respirator
3M™ Secure Click™ Half Facepiece Reusable Respirators HF-800 Series
- Compatible with 3M™ PAPR Systems
No
- Compatible with 3M™ Supplied Air System
No
- C

3M™ Secure Click™ Hard Case P100 Particulate Filter D9093CB, with Nuisance Level Acid Gas Relief, 144 ea/Case

3M Product Number D9093CB 3M ID 7100206896 UPC 50689330191548

Details

- 99.97% filter efficiency meets NIOSH P100 test criteria
- Use with 3M™ Secure Click™ Respirators
- Hard case recommended for harsh environments with a need for easy decontamination and protection
- Hard case helps protect against sparks and high heat
- Filter case designed for certain spray applications
- Secure Click™ connection allows filters to be inserted into place for ease of assembly
- Solid top and channeled airflow help protect filter
- Swept-back design provides wide field of view
- Nuisance odor relief for organic vapors and acid gas levels below the OSHA Permissible Exposure Level (PEL)

Typical properties

- Accessories
No
- Brands
Secure Click™
- Cartridge or Filter Type
Combination
- Compatible Respirator
3M™ Secure Click™ Half Facepiece Reusable Respirators HF-800 Series
- Compatible with 3M™ PAPR Systems
No
- Compatible with 3M™ Supplied Air System
No
- C
C

FUTURO™ Dress Socks for Men, Moderate Compression

3M ID CBGBLW011021 UPC 00051131215962

Details

Moderate Compression (15-20 mm/Hg)
Use for tired or achy legs, swelling, mild spider and varicose veins
Ideal for standing or sitting all day, traveling or active office work
Graduated compression helps improve circulation
Great for business casual or weekend wear
Comfort band ensures socks stay in place
Durable, reinforced toe and heel provide lasting wear
Made from a comfortable blend of nylon and spandex
Size: M, L
Color: Black

Typical properties

Body Part
Leg
Brands
FUTURO™
Factory ISO Certification
No ISO Certification information available
Material
Nylon, Spandex
Product Color
Black
Product Type
Socks
Product Usage
Being on Feet All Day, DVT, Swelling, Travelling, Varicose Veins
S

3M™ Worktunes™ AM/FM Hearing Protector, 90541H1-DC-PS, 4 eaches/case

3M ID 70006983178 UPC 00078371905415

Details

Noise Reduction Rating (NRR) of 24 dB*

Great AM/FM radio performance and bass boost option for enhanced listening experience

Audio Assist Technology provides operational and set-up guidance—without having to take off the headset

Audio Assist Technology helps you program up to 50 AM/FM radio stations and lets you know when your battery is running low

Auto-scanning helps you quickly find and save your favorite stations

Plug into your smartphone or other mobile device to enjoy entertainment of your choice

Easy-to-use controls can be operated even while wearing work gloves

Rugged design is great for everyday use

Makes an excellent gift for the yard or woodworking enthusiast

Automatic shut-off helps extend the life of your batteries

Requires 2 AA batteries (not included)

*CAUTION: 3M strongly recommends fit testing of hearing protectors. Research suggests that many users will receive less noise reduction than indicated by the NRR due to variation in hearing protector fit, fitting skill and motivation of the user. If the NRR is used, 3M recommends that it be reduced by 50% or in accordance with applicable regulations

Typical properties

Attenuation Rating

24 dB

Audio Type

Music/Entertainment

Battery Type

Disposable AA

Brands

3M™

Catalog Number

90541H1-DC-PS

Communication Direction

Listen-only

Connection Type

Wired

Factory ISO Certification

No ISO Certification information

3M™ 52P71 Disposable Respirator Paint Project

3M ID CBGNAW011123 UPC 00051131918047

Details

NIOSH-APPROVED OV CARTRIDGE for use against certain organic vapors
NIOSH-APPROVED P95 filters for at least 95% filtration efficiency against solids
and liquid aerosols, as well as oil-based particulates

FOR WORKPLACE/OCCUPATIONAL APPLICATIONS ONLY

OIL PROOF (Use according to manufacturer's time use restrictions when oil
aerosols are present)

READY TO USE respirator with permanently affixed organic vapor cartridges

ADJUSTABLE HEAD STRAPS allow for personalized fit

LIGHTWEIGHT WELL-BALANCED DESIGN enhances comfort

CONVENIENT, DISPOSABLE DESIGN

SOFT, THERMOPLASTIC FACESEAL for comfort

HALF-FACE RESPIRATOR is designed to help deliver comfort and protection

NON-REPLACEABLE 5000 SERIES OV CARTRIDGE HELPS REDUCE

EXPOSURE to certain organic vapors encountered during activities involving

latex and oil-based painting, including paint spraying*, varnishes, stains,

sealants, solvents, certain solvent-based cleaners or pesticides** *Use a prefilter
when spraying **Refer to Pesticide Product Label for Respirator Guidance or call

3M at 1-800-243-4630 or In Canada, call 1-800-267-4414

5P71 FILTER HELPS REDUCE EXPOSURE to certain particles from paint

spraying*, spray adhesives and pesticides** *Use a prefilter when spraying

**Refer to Pesticide Product Label for Respirator Guidance or call 3M at 1-800-
243-4630 or In Canada, call 1-800-267-4414

Kit contents: one facepiece, one pair of permanent, non-replaceable 5000 series
cartridges, one pair 501 retainer and one pair replaceable 5P71 filters

Size: Medium

Contains no components made from natural rubber latex

Typical properties

Catalog Number

52P71P1-C-M,52P71C1-DC,52P71P1-C

Exhalation Valve

No

Factory ISO Certification

No ISO Certification information available

Product Color

Gray

eClass 14 Classification Group

40220112

3M™ Hard Hat with Ratchet Adjustment Yellow

3M ID CBGNAW011147 UPC 10078371620100

Details

Smooth-turning 4-point ratchet suspension system
Lightweight protection and durability
Ratchet adjustment for custom, on-head sizing
Yellow, low profile hard hat for stability and balance
Ventilated foam brow pad for comfort and ventilation
ANSI compliant when worn in the forward and reverse donning positions
Meets requirements of ANSI Z89.1-2014 Type 1, Class G and E
Contains 1 hard-hat/pack
Meets CSA Z94.1-2015 Type 1, Class G and E requirements

Typical properties

Electrical Class
C, E, G
Factory ISO Certification
No ISO Certification information available
Hard Hat Type
Type I
Product Type
Front Brim Hard Hat
Shell Material
HDPE
Specifications Met
ANSI Z89.1-2003
Suspension Type
4 Point Ratchet
Sweatband

Dimensions and Classifications

Overall Height (Imperial)
7 in
Overall Height (Metric)
17.78 cm
Overall Length (Imperial)
11 in
Overall Length (Metric)
27.94 cm
Overall Width (Imperial)
8.5 in
Overall Width (Metric)
21.59 cm

91295-80025T 3M(TM) Tekk Protection(TM) Hard Hat White 12/case

3M ID 70005087781 UPC 10078371612297

Details

Three levels of height adjustment promote optimal comfort
Suspension system sits low on the back of your head to reduce pressure points
Pinlock strap provides a secure, customizable fit
Low-profile design enhances stability for balanced comfort
Can be worn in reverse position for increased upward visibility
Replaceable standard brow pad
Compatible with many types of additional PPE
Compliant with ANSI/ISEA requirements when worn in forward and reverse positions
Meets the requirements of ANSI/ISEA Z89.1 Type 1, Class G and E
Meets the requirements of CSA Z94.1 Type 1, Class G and E
Clean your hard hat with mild soap and water
Color: White
Package contents: 1 Hard Hat
For product questions, call 3M Product Application Support team at 1-800-494-3552

Typical properties

Brands
3M™
Factory ISO Certification
No ISO Certification information available
eClass 14 Classification Group
40300202

94601-80030T 3M(TM) Tekk Protection(TM) Reflective Clothing Day/Night Safety Vest, 8/case

3M ID 70005081909 UPC 10078371625570

Details

3M™ Scotchlite™ Reflective Material offers high visibility when illuminated by a light source

Ventilated fabric helps keep you cool

Lightweight design for a comfortable fit

Neon fabric offers visibility during the daytime

Adjustable design lets you customize your fit

Increased visibility when outside walking or running

Interior convenient pocket holds your cell phone

3M™ Safety Vest is machine washable

Intended for recreational use only

One size fits most

For product questions, call 3M Product Application Support team at 1-800-494-3552

For product questions, call 3M Product Application Support team at 1-800-494-3552

Typical properties

Brands

3M™

Factory ISO Certification

No ISO Certification information available

eClass 14 Classification Group

40010100

3M™ Hi-Viz Hard Hat Sun Shade, 94800-80030, Yellow, 8/case

3M ID 70006932431 UPC 00051141401898

Details

Available in fluorescent yellow with orange trip and 1/2" 3M™ Scotchlite™ Reflective Material
Made of lightweight, breathable mesh for increased air circulation and faster drying times
Hard hat not included
One size fits most hard hats
Meets the requirements of ANSI/ISEA 107-210 Certified Headwear

Typical properties

Brands
3M™
Factory ISO Certification
No ISO Certification information available
Features
1/2" 3M™ Scotchlite™ Reflective Material
Product Type
Sun Shade
eClass 14 Classification Group
46080105

Peltor™ Sport RangeGuard™ Electronic Hearing Protector

3M ID CBGNAR2348 UPC 00051141990590

Details

NRR: 21 dB noise reduction rating

IDEAL FOR both indoor and outdoor shooters and hunters

SUPPRESSES gunshot noise to protect hearing while amplifying voices for clear communication

DURABLE RECESSED MICROPHONES prevent damage and reduce wind noise

LOW-PROFILE CUPS with cut-outs designed for rifle and shotgun use

ADJUSTABLE HEADBAND for a comfortable fit

RUNS ON 2 AAA BATTERIES (not included)

3.5 mm audio input jack compatible with most MP3 players and 2-way radios

Durable recessed microphones

Typical properties

Battery Type

Disposable AAA

Catalog Number

RG-OTH-4, RG-OTH-1-W

Factory ISO Certification

No ISO Certification information available

eClass 14 Classification Group

40270191

3M™ Performance Safety Eyewear, Aerodynamic Design, 47090-WZ4, Black w/Red Accent Frame, Clear Lens, Anti-Fog

3M ID 70006950615 UPC 00076308725860

Details

Durable lenses help provide limited protection from light to moderate impact hazards
Lightweight, durable design for comfort and lasting wear
Brow guard helps keep sweat and debris out of your eyes
Compatible with many types of additional Personal Protection Equipment (PPE)
Soft-touch nose pads and earpiece enhance comfort
Contoured wrap-around design provides extended eye protection and unobstructed view
Anti-fog, scratch-resistant lens helps keep vision clear
Impact-resistant lens blocks 99.9% of UV rays
Includes a handy storage bag and lanyard to help prevent damage and loss
Meets the requirements of ANSI Z87.1 , CSA Z94.3 and AS/NZS 1337
Clear lenses help provide excellent visibility and can be used indoors or outdoors
Color: Clear

Typical properties

ANSI Requirements
ANSI Z87.1-2010
Brands
3M™
Factory ISO Certification
No ISO Certification information available
Features
Large, Full-coverage Lenses with Built-in Brow Guard Helps Keep Sweat & Debris Away From Eyes
Frame Color
Black/Red
Lens C

3M™ Professional Multi-Purpose Respirator with Quick Latch 65023QLHA1C-PS, 1/pk, 4 pks/case

3M ID 70006963071 UPC 00076308726522

Details

NIOSH-APPROVED 60923 OV/AG/P100 CARTRIDGE filters at least 99.97% of solids and liquid aerosols, as well as oil-based particulates
HELPS REDUCE EXPOSURE to certain organic vapors encountered during activities involving latex and oil-based painting, including paint spraying, varnishes, stains, sealants, solvents, certain solvent-based cleaners or pesticides*. *Refer to Pesticide Product Label for Respirator Guidance or call 3M at 1-800-243-4630 or In Canada, call 1-800-267-4414
ALSO HELPS REDUCE EXPOSURE against certain acid gases such as heavy-duty cleaners/bleach, sealants and pool chemicals/treatments
FOR WORKPLACE/OCCUPATIONAL USE ONLY
OIL PROOF P-series particulate filter (Use according to manufacturer's time use restrictions when oil aerosols are present)
QUICK LATCH SYSTEM easy, one handed- on/off and makes it easy to drop respirator down from face without removing straps in a non-contaminated area
ADJUSTABLE HEAD STRAPS allow for a personalized fit
VALVE COVER DESIGN directs exhaled breathe and moisture downward
CONVENIENT, REUSABLE DESIGN
DURABLE DESIGN for lasting wear
LIGHTWEIGHT, SILICONE FACESEAL for premium comfort
3M™ BAYONET CONNECTION compatible with 3M™ cartridges and filter
KIT CONTENTS: one facepiece, one pair of replaceable organic vapor/acid gas/P100 particulate filters (#60923)
Replacement filters available for economic repeat use of the facepiece (part #60923)
Contains no components made from natural rubber latex

Typical properties

Application Type
Multi-Purpose
Brands
3M™
Cartridge or Filter Included
Yes
Cartridge or Filter Type
Gas & Vapor
Catalog Number
65023QLHA1C-PS
Clip-on Welding Shield
No
Compatible with 3M™ PAPR Systems
No
Compatible with 3M™ Supplied Air Syst

Dimensions and Classifications

Overall Height (Imperial)
9.6 in
Overall Height (Metric)
24.384 cm
Overall Length (Imperial)
5.5 in
Overall Length (Metric)
13.97 cm
Overall Width (Imperial)
10 in
Overall Width (Metric)
25.4 cm

3M™ TEKK Protection™ SecureFit™ Safety Eyewear SF201-PV6, Tinted/AF Lens

3M ID 70006919545 UPC 00051141388946

Details

Lightweight, flat-temple, low-profile design works seamlessly with hearing protection

Wear all day - forget you have them on

Impact-resistant lenses block 99.9% of UV radiation

Flexible temples

Anti-fog lens coating

Meets the requirements of ANSI Z87.1-2010

Adjustable nose pads and soft-touch inlays increase comfort and provide grip

Contains 1 safety eyewear/pack

Typical properties

ANSI Requirements

ANSI Z87.1-2010 and CSA Z94.3-2007

Brands

3M™

Factory ISO Certification

No ISO Certification information available

Features

3M™ Pressure Diffusion Temple Technology

Frame Color

Gray

Lens Coating

Anti-fog

Lens Color

Tinted

L

3M™ E-A-Rsoft™ SuperFit™ Earplugs 311-4109, Metal Detectable, 2000 Pair/Case

3M Product Number 311-4109 3M ID 7010384671 UPC 10080529191035

Details

Metal Detectable earplug

Designed specifically for applications such as food processing, where detection of foreign objects is desired

Features the proprietary SuperFit™ fitting ring to help insure proper fit

Stainless steel ball bearing implanted into the plug

Metal detectable cord

Typical properties

Attenuation Rating

32.0 Decibel

Banded

No

Battery Type

1 AA Battery

Brands

3M™

Case Quantity

2000

Cord Color

Blue

Cord Material

Metal Detectable Cord

Cord Type

Metal Detectable Cord

Corded

Yes

Dielectric

No

Dispenser Available

No

Ear

3M™ Solus™ 2000 Series, S2015AF-BLU, Blue/Gray Temples, Clear Reader + 1.5 Anti-Fog/Anti-Scratch Lens, 20 ea/Case

Part Number S2015AF-BLU 3M Product Number S2015AF-BLU 3M ID 7100221704

Details

Stylish, low profile half frame 3M™ Solus™ Safety Readers Range with adjustable ratchet temples to adjust the lens for facial features and eyeglass position

Available in a range of diopters: +1.5, +2.0 or +2.5

Semi-soft nose and soft temple ends to improve comfort and fit

Anti-Scratch/Anti-Fog Coating Performance

Typical properties

Anti Fog Lens

Yes

Brands

Solus™

Case Quantity

20

Class

Premium

Comfort Features

Adjustable lens angles, Color-accented temples, Dual-injected, Durable construction, Lens angle adjustment, Multiple Lens Angles, Polycarbonate lens, Sporty wraparound

3M™ Solus™ 2000 Series, S2020AF-BLU, Blue/Gray Temples, Clear Reader +2.0 Anti-Fog/Anti-Scratch lens, 20 ea/Case

Part Number S2020AF-BLU 3M Product Number S2020AF-BLU 3M ID 7100222269

Details

Stylish, low profile half frame 3M™ Solus™ Safety Readers Range with adjustable ratchet temples to adjust the lens for facial features and eyeglass position

Available in a range of diopters: +1.5, +2.0 or +2.5

Semi-soft nose and soft temple ends to improve comfort and fit

Anti-Scratch/Anti-Fog Coating Performance

Typical properties

Anti Fog Lens

Yes

Brands

Solus™

Case Quantity

20

Class

Premium

Comfort Features

Adjustable lens angles, Color-accented temples, Dual-injected, Durable construction, Lens angle adjustment, Multiple Lens Angles, Polycarbonate lens, Sporty wraparound

3M™ Solus™ 2000 Series, S2025AF-BLU, Blue/Gray Temples, Clear Reader +2.5 Anti-Fog/Anti-Scratch lens, 20 ea/Case

Part Number S2025AF-BLU 3M Product Number S2025AF-BLU 3M ID 7100222135

Typical properties

Anti Fog Lens

Yes

Brands

Solus™

Case Quantity

20

Class

Premium

Comfort Features

Adjustable lens angles, Color-accented temples, Dual-injected, Durable construction, Lens angle adjustment, Multiple Lens Angles, Polycarbonate lens, Sporty wraparound

3M™ Scott™ ELSA Emergency Escape Breathing Device Carry Bag-N

3M ID B5005297015

Details

5 Min-N, 10 Min-N, and 15 Min-N Carry Bags Available
Spare Part

Typical properties

Brands
Scott™
eClass 14 Classification Group
40220191

3M™ DBI-SALA® EZ-Stop™ Arc Flash 100% Tie-Off Web Loop Stretch Web Shock-Absorbing Lanyard 1246532, Kevlar® Fiber, 6 ft

3M Product Number 1246532 3M ID 7012817325

Details

Stretches in reaction to users movements
Energy absorbing design limits fall arrest forces
Abrasion-resistant webbing
Available in a wide range of web styles and designs
Built-in impact indicator
Protected labels equipped with 3M™ Connected Safety ID (CSID)
Ideal for the following applications: Construction, General Industrial, Mining, Oil & Gas, Transportation, Utilities, and Wind Energy

Typical properties

Anchor Connection Type
Rebar Hook
Anchor Hook Material
Zinc Plated Steel
Brands
DBI-SALA®
Case Quantity
1
Connected Safety ID Equipped
Yes
Energy Absorber Class
6 ft (1.8 m) Free Fall/MAAF 900 lbs. (4 kN)
Harness Connection Hook Material
None

Dimensions and Classifications

Overall Length (Imperial)
6 ft
Overall Length (Metric)
1.83 m

3M™ S-Series PAPR Headcovers & Headcover Assemblies

Details

For use with certain 3M™ Powered Air Purifying Respirators and Supplied Air Respirator Systems
Provides limited head and face coverage
Provides limited face and eye protection from liquid splash, low energy flying particles and dust
Provides excellent field of view
Suitable for applications which require frequent replacement of the entire headtop assembly
No assembly required; ready to use out of the box

Typical properties

Assigned Protection Factor
25
CFM Capacity per Minute
100 CFM, 50 CFM
Case Quantity
5,20
Compatible With
3M™ Powered Air Purifying and Supplied Air Respirator Systems
Headgear Type
Head Cover with Suspension, Headcover
High Heat
No
Material
P

3M™ Speedglas™ G5-03 Head Cover Holder 46-0700-00

3M Product Number 46-0700-00 3M ID 7100319677 UPC 00638060431221

Details

Spare part

Typical properties

Brands
Speedglas™
Compatible Welding Helmet
G5-03 Series
Part Type
Spare Part
Product Series
G5
Product Type
Headcovers
eClass 14 Classification Group
40300190

FUTURO™ Pantyhose for Women

3M ID CBGBLW011020 UPC 00051131215825

Details

Firm Compression (20-30 mm/Hg)
Graduated compression helps improve circulation
Helps relieve symptoms of moderate-to-severe varicose veins and swelling
Ideal for standing or sitting all day, traveling or active office work
Durable, reinforced toe and heel provide lasting wear
Made from a comfortable blend of nylon and spandex
Brief cut offers a comfortable fit
Size: M,L,Plus

Typical properties

Body Part
Leg
Brands
FUTURO™
Factory ISO Certification
No ISO Certification information available
Foot Style
Closed Toe
Material
Nylon, Spandex
Product Color
Beige, Nude
Product Type
Pantyhose
Product Usage
Chronic Leg Conditions, DVT, Swel

90537-80025T 3M(TM) Tekk Protection(TM) Band Style Hearing Protector, 6/case

3M ID 70005087955 UPC 10078371613171

Details

Pliable foam ear tips conform to the shape of your ear canal to help block out hazardous noise

Soft, smooth ear tips enhance comfort for extended wear

Attached band rests around your neck when not in use

Ear tips are removable and replaceable – 3M style 90538

Easy to insert and remove

Lightweight alternative to earmuffs

Highly visible color for easy location on a busy jobsite

Great for use with additional Personal Protection Equipment (PPE)

Noise Reduction Rating (NRR) of 28 dB*

Pivoting tips that move with the wearer to help provide consistent protection

Helps protect against harmful noises that are at 85 dB and above

Package contents: 1/Pack

Typical properties

Attenuation Rating

28.0 Decibel

Brands

3M™

Factory ISO Certification

No ISO Certification information available

Product Color

Orange

Product Type

Earmuff

Project Applications

Installing Flooring and Trim, Laying tile, Refinishing Floors, Refini

3M™ Hi-Viz Vest, Class 3, Short Sleeve, 94900-80030, Yellow, 5/case

3M ID 70006932423 UPC 00051141401867

Details

3M™ Scotchlite™ Reflective Material offers high visibility when illuminated by a light source
360 degrees of reflectivity offers exceptional visibility on the job
Lightweight design for a comfortable fit
Neon fabric offers great visibility during the daytime
For occupational workers who are exposed to roadway traffic and who work in an environment with moving equipment/vehicles
Designed for high-risk activities like directing traffic on highways, construction, utility, emergency services and working in inclement weather conditions like hurricanes and blizzards
3M™ Safety Vests are machine washable
Compatible with many types of additional PPE
Intended for professional use
Class 3 vest meets the requirements of ANSI/ISEA 107-2010
Complies with the Federal Highway Mandate (2009) Manual of Uniform and Traffic Control Devices
One size fits most
Color: Yellow
Package Contents: 1 Vest
For product questions, call 3M Product Application Support team at 1-800-494-3552

Typical properties

ANSI Requirements
ANSI/ISEA 107-2010 Class 3 and Federal Highway Mandate- 2009 Manual of Uniform and Traffic Control Devices
Brands
3M™
Factory ISO Certification
No ISO Certification information available
Product Type
High Visibility
Project Appli

Peltor™ Sport Ultimate Hearing Protector

3M ID CBGNARUS2508 UPC 00051125005661

Details

Our highest-NRR earmuff
Lightweight and comfortable for extended wear
Fully adjustable headband ergonomically engineered to reduce pressure points
Open frame reduces heat buildup and improves comfort when worn with hats/caps
Soft, conformable rings provide a better seal
Stylish, two-color design

Typical properties

Attenuation Rating
30.0 Decibel
Catalog Number
97042-PEL-6C
Factory ISO Certification
No ISO Certification information available
Product Type
Earmuff
Project Applications
DIY and Professional, Installing Flooring and Trim, Laying tile, Refinishin

3M™ SecureFit™ 400 Safety Eyewear SF400G-LV-4-PS, Gray Anti-Fog, 1 Eyewear, 4/case

3M ID 70006968930 UPC 00076308913564

Details

Lightweight, flat-temple, low-profile design works seamlessly with hearing protection

Wear all day - forget you have them on

Impact-resistant lenses block 99.9% of UV radiation

Flexible temples

Anti-fog lens coating

Meets the requirements of ANSI Z87.1-2010

Adjustable nose pads and soft-touch inlays increase comfort and provide grip

Contains 1 safety eyewear/pack

Typical properties

Brands

3M™

Catalog Number

SF400G-LV-4-PS

Factory ISO Certification

No ISO Certification information available

eClass 14 Classification Group

40230101

FUTURO™ Performance Compression Calf Sleeve

3M ID CBGBLRUS1490 UPC 00051131204959

Details

Provides all over, even compression to areas covered by the sleeve
Four-way stretch fabric and ergonomic construction enable a wide range of motion
Low-profile, breathable fabric helps keep air flowing
Great for everyday use, travel and during athletic activities
Simply hand wash with mild soap and air dry
Supported by our expert panel of engineers and medical professionals
Includes one compression sleeve
Size: S/M, L/XL

Typical properties

Body Part
Calf
Brands
FUTURO™
Factory ISO Certification
No ISO Certification information available
Fit Range
S/M fits: 13" to 15.25"
L/XL fits: 15.25" to 17.5"
Material
Polyester, Spandex
Product Color
Gray
Product Type
Sleeve
Product Us

3M™ Performance Particulate Respirator 8210Plus

3M ID CBGNAWUS1818 UPC 00638060137284

Details

NIOSH-APPROVED N95 for at least 95 percent filtration efficiency against certain non-oil-based particles and aerosols

ADVANCED FILTER MEDIA for easy breathing

CUSHIONING NOSE FOAM rests on bridge of nose for comfort

ADJUSTABLE NOSECLIP helps ensure a custom, secure seal

STRETCHABLE, BRAIDED HEADBANDS: With staple-free attachment for comfort

LIGHTWEIGHT DESIGN for comfort

CONVENIENT, DISPOSABLE DESIGN

RECOMMENDED FOR use when sanding, sawing, grinding, lawn mowing, sweeping, drywall sanding, grinding, woodworking and working with fiberglass insulating particles

ALSO HELPS PROTECT AGAINST: certain particles such as mold, granular pesticides, allergens and dust

Contains no components made from natural rubber latex

Available in multiple package quantities

Typical properties

Cool Flow™ Exhalation Valve

No

Enhanced Comfort

No

Enhanced Durability

No

Exhalation Valve

No

Faceseal

Yes

Factory ISO Certification

No ISO Certification information available

Filter Class

N95, P95

Hazard Type

Fiberglass, Grinding, Sanding

3M™ Scotchlite™ Reflective Material 8912 Series

Details

3M™ Scotchlite™ Reflective Material is designed for enhancing visibility in low light and nighttime conditions
Certified to various global high visibility standards such as ANSI/ISEA 107
Backside printed for authentication
Standard product has a “3M” image on its reflective surface, but can be purchased without it
Sew-on application

Typical properties

Adhesive
None
Attachment Type
Sew On
Backing
None
Backing Material
Polyester/Cotton
Brands
Scotchlite™
Certified Performance Required
ANSI 107-2015, CSA Z95-2015, Oeko-Tex
Daytime Color
Silver
Dry-Cleaning Cycles at ANSI Certified Standards

Dimensions and Classifications

Overall Length (Imperial)
54.68 yd, 109.36 yd, 218.72 yd, 656.17 yd
Overall Length (Metric)
50 m, 100 m, 200 m, 600 m
Overall Width (Imperial)
0.75 in, 1 in, 2 in, 2.75 in, 24 in, 36 in, 42 in, 50 in
Overall Width (Metric)
19.05 mm, 25.4 mm, 50.8 mm

3M™ Scotchlite™ Reflective Material C925 Series

Details

3M™ Scotchlite™ Reflective Material is designed for enhancing visibility in low light and nighttime conditions
Not certified to occupational high-visibility garment standards
Sew-on application
Cotton/ Polyester Fabric

Typical properties

Adhesive
None
Attachment Type
Sew On
Backing
None
Brands
Scotchlite™
Daytime Color
Silver
Flame Resistant
No
Initial Average RA
500
Product Series
C925
Technology
Beaded
Wash Method
Home Wash

Dimensions and Classifications

Overall Length (Imperial)
54.68 yd, 656.17 yd
Overall Length (Metric)
50 m, 600 m
Overall Width (Imperial)
24 in, 50 in
Overall Width (Metric)
609.6 mm, 1270 mm

3M™ Sanding Respirator, 03201, 2 per pack, 12 packs per case

3M ID 60455069074 UPC 00051131335011

Details

Disposable respirator offers 95 percent filtration efficiency against particulates
Lightweight design won't burden wearer during projects
Use for non-harmful dusts when sanding and sawing
Adjustable nose clip for a good seal and a snug fit
NIOSH approved: N95

Typical properties

Brands
3M™
Exhalation Valve
No
Factory ISO Certification
No ISO Certification information available
Filter Class
N95
Registered Medical Device
No
Respirator Size
Standard
Specifications Met
Assigned Protection Factor (ADF) = 10
Total Units p

3M™ PELTOR™ SoundTrap™ Slimline Earmuff MT15H67FB, Tactical Electronic Headset Headband, 1 EA

3M Product Number MT15H67FB 3M ID 7100009538 UPC 07318640002401

Details

A premier hearing protection and communication solution for high noise environments
Environmental microphones allow face-to-face conversation and improved situational awareness in quiet and low-to-moderate levels of noise
Great for hunters and shooters
Foam and liquid-filled cushions provide lasting comfort and an effective acoustic seal for long duration wear times
Foldable, adjustable headband provides a comfortable and secure fit, and folds over the earcups for compact storage
Features dual volume controls
Auxiliary ports allow for connection to external devices (audio cable not included)

Typical properties

Attenuation Rating
21 dB
Audio Type
Environmental Listening
Auxiliary Port
J22
Battery Life
Approx. 200 hours
Brands
PELTOR™
CSA Class
White
Communication Direction
Listen-only
Communication Type
Environmental Listening
Hearing Protection

**3M™ PELTOR™ Headset Carrying Drawstring Bag, Coyote Brown,
FP9007-Draw,
1 EA/Case**

3M Product Number FP9007-DRAW 3M ID 7010384657 UPC 00093045935109

Details

Coyote Brown drawstring bag for carrying and storing your headset and accessories
1 EA/Case

Typical properties

Brands
PELTOR™
Product Color
Beige
Product Type
Carrying Bag
Purpose
Military/Police
Spare Part Type
Carrying Bag
eClass 14 Classification Group
40270191

3M™ Peltor™ E-A-R buds™ Corded Earplugs 2600, Replacement Tips 3 EA/Bag

3M Product Number EARbudtips 3M ID 7000127615 UPC 10080529190540

Details

The soft, flexible flanges of the UltraFit™ Communication Eartips adapt to the shape of the ear canal to comfortably reduce exposure to noise

Reuseable

Moisture resistant

No roll down required

Typical properties

Brands

PELTOR™

Hearing Protection Style

Earplugs

Hearing Protection Type

Reusable Earplugs

Product Color

Gray

Product Type

Communication Eartip

eClass 14 Classification Group

40270191

3M™ SecureFit™ 600 Series Safety Glasses

Details

3M's innovative temple design features slotted ribs that provide comfortable pressure equalization, allowing the temples to flex and self-adjust to the size of the wearer's head

Curved temples apply pressure to the less sensitive back of the head, instead of the temples, achieving a comfortable fit even during rapid head movement

Sturdy, yet stylish dual lens frame

Available in multiple lens color options, including photochromic and polarized lenses

Choose from models with anti-scratch, anti-fog/anti-scratch or optional 3M™ Scotchgard™ Protector Anti-Fog Coating

U6 rated polycarbonate lenses absorb 99.9% of UVA, UVB, and UVC rays between 200 nm and 380 nm

Meets the Impact-Rated Protector requirement of the ANSI-ISEA Z87.1 Standard

Typical properties

3M Technology

Pressure Diffusion Temple

ANSI Requirements

ANSI Z87.1-2003 and CSA Z94.3-2007

Anti Fog Lens

Yes

Brands

SecureFit™

Case Quantity

20

Comfort Features

Contains Foam Gasket, Enhanced temple comfort without compromising the security o

Dimensions and Classifications

Overall Height (Imperial)

10 in

Overall Height (Metric)

25.4 cm

Overall Length (Imperial)

10 in

Overall Length (Metric)

25.4 cm

Overall Width (Imperial)

5 in

Overall Width (Metric)

12.7 cm

3M™ PELTOR™ G79 Series Motorsport Communication Adaptor Cable FL6U-32, -77Flex Motorola GP340/328 1 EA/Case

3M Product Number FL6U-32 3M ID 7100064602 UPC 07318640040069

Details

A patch cable that can be used to connect to a two-way radio
Compatible with the 3M™ PELTOR™ ORA TAC Headset and the WS™
ProTac™ XP Headsets
To determine the appropriate flex cable for your two-way radio, please visit
3M.com/PeltorAdapters
18" curly cable

Typical properties

Auxiliary Port
Flex
Brands
PELTOR™
Compatible Radio Brands
Motorola
Intrinsically Safe
No
Plug Type
Motorola HT750
Product Color
Black
Product Type
Cable
Recommended Industry
Agriculture
eClass 14 Classification Group
40270191

**3M™ PELTOR™ G79 Series Motorsport Communication Adaptor
Cable FL6U-28,
-77 Flex 2.5 mm stereo, 1 ea/cs**

3M Product Number FL6U-28 3M ID 7100064305 UPC 07318640039445

Typical properties

Auxiliary Port
Flex
Brands
PELTOR™
Compatible Radio Brands
Ericsson
Intrinsically Safe
No
Product Type
Cable
Purpose
Exclude
Recommended Industry
Racing
Specifications Met
CE Approved
eClass 14 Classification Group
40270191

3M™ PELTOR™ G79 Series Motorsport Communication Adaptor Cable FL6U-21, -77 Flex Motorola GP300, CP040 1 EA/Case

3M Product Number FL6U-21 3M ID 7100064359 UPC 07318640039933

Details

A patch cable that can be used to connect to a two-way radio
Compatible with the 3M™ PELTOR™ ORA TAC Headset and the WS™
ProTac™ XP Headsets
To determine the appropriate flex cable for your two-way radio, please visit
3M.com/PeltorAdapters
18" curly cable

Typical properties

Auxiliary Port
Flex
Brands
PELTOR™
Case Quantity
10
Compatible Radio Brands
Motorola
Intrinsically Safe
No
Plug Type
Two-pin
Product Color
Black
Product Type
Cable
Recommended Industry
Agriculture
eClass 14 Classification Group
40270191

3M™ PELTOR™ External Radio Patch Cord FL6BR, 1 EA/Case

3M Product Number FL6BR 3M ID 7100016085 UPC 07318640045859

Details

Patch cable for connecting the 3M™ PELTOR™ LiteCom Plus or LiteCom Pro II Headset to a PTT adapter
CAUTION: Not certified for Intrinsic Safety
1 EA/Case

Typical properties

Auxiliary Port
4-pin XLR
Brands
PELTOR™
Compatible Radio Brands
Alan
Intrinsically Safe
No
Plug Type
NEXUS® TP-120
Product Color
Black
Product Type
Patch Cord
Recommended Industry
Agriculture
eClass 14 Classification Group
40270191

3M™ PELTOR™ Flex Cable for MOTOTRBO, FL6U-63, 1 EA/Case

3M Product Number FL6U-63 3M ID 7000108535 UPC 07318640063235

Details

A patch cable that can be used to connect to a two-way radio
Compatible with the 3M™ PELTOR™ ORA TAC Headset and the WS™
ProTac™ XP Headsets
To determine the appropriate flex cable for your two-way radio, please visit
3M.com/PeltorAdapters
18" curly cable

Typical properties

Auxiliary Port
Flex
Brands
PELTOR™
Compatible Radio Brands
Motorola
Intrinsically Safe
No
Plug Type
Motorola TRBO
Product Color
Black
Product Type
Cable
Recommended Industry
Agriculture
eClass 14 Classification Group
40270191

3M™ PELTOR™ Replacement Earplug TEP-300R CY, Right, Coyote Brown, 20 ea/Case

3M Product Number TEP-300R CY 3M ID 7100227632 UPC 00638060429891

Details

Intuitive one-button operation turns unit on, off, and selects volume settings
Charging contacts recharge the unit while in the case
Internal earpiece Li-ion battery provides up to 10 hours of continuous operation when fully charged
Innovative design helps protect earpiece against water and dust ingress

Typical properties

Battery Type
Rechargeable Li-ion Pack
Brands
PELTOR™
Case Quantity
20 ea / cs
Compatible With
TEP-300 Tactical Earplug
Product Color
Coyote Brown
Product Type
Replacement Earplug
eClass 14 Classification Group
40270191

3M™ PELTOR™ TEP-100C, Tactical Earplug Replacement Charging Case, 1 ea/Case

3M Product Number TEP-100C 3M ID 7100066370 UPC 00078371665241

Details

Replacment Charging Station Case for 3M PELTOR Tactical Earplugs, TEP-100 and TEP-200
1 EA/Case

Typical properties

Auxiliary Port
Micro USB Charging Port
Brands
PELTOR™
Case Quantity
1
Intrinsically Safe
No
Product Color
Black
Product Type
Case
Recommended Application
Law Enforcement, Military, Tactical
Recommended Industry
Hunting, Law Enforcement, Mil

3M™ PELTOR™ Replacement Earplug TEP-300R TN, Right, Tan, 20 ea/Case

3M Product Number TEP-300R TN 3M ID 7100227649 UPC 00638060429914

Details

Intuitive one-button operation turns unit on, off, and selects volume settings
Charging contacts recharge the unit while in the case
Internal earpiece Li-ion battery provides up to 10 hours of continuous operation when fully charged
Innovative design helps protect earpiece against water and dust ingress

Typical properties

Battery Type
Rechargeable Li-ion Pack
Brands
PELTOR™
Case Quantity
20 ea / cs
Compatible With
TEP-300 Tactical Earplug
Product Color
Tan
Product Type
Replacement Earplug
eClass 14 Classification Group
40270191

3M™ PELTOR™ Replacement Earplug TEP-300L CY, Left, Coyote Brown, 20 ea/Case

3M Product Number TEP-300L CY 3M ID 7100227644 UPC 00638060429907

Details

Intuitive one-button operation turns unit on, off, and selects volume settings
Charging contacts recharge the unit while in the case
Internal earpiece Li-ion battery provides up to 10 hours of continuous operation when fully charged
Innovative design helps protect earpiece against water and dust ingress

Typical properties

Battery Type
Rechargeable Li-ion Pack
Brands
PELTOR™
Case Quantity
20 ea / cs
Compatible With
TEP-300 Tactical Earplug
Product Color
Coyote Brown
Product Type
Replacement Earplug
eClass 14 Classification Group
40270191

3M™ PELTOR™ TEP-100E Tactical Earplug Replacement Earpiece, 1 EA/Case

3M Product Number TEP-100E 3M ID 7100066369 UPC 00078371665234

Details

Replacement Earpiece for 3M PELTOR TEP-100 Tactical Earplug
Intuitive one-button operation turns unit on and off and selects high or normal volume setting
Lithium-Ion battery provides up to 16 hours of continuous operation between charges
Portable charging case powered by 3 AA alkaline batteries or USB (Micro B) port
Choice of replaceable communications eartips designed to fit most ear canal sizes: UltraFit™ Communication Tip (23dB), Triple C Communication Tip (27dB), and Skull Screw Communication Tip (30dB)
Tactical earplugs and portable charging station (with cover and USB ports closed) are IP67 compliant and water resistant (immersion of up to 1 meter for 30 minutes)
Innovative microphone port design helps protect eartips against water ingress
Portable charging station helps protect earplugs in wet and austere environments
Compatible with most headborne Personal Protective Equipment such as helmets, hardhats, eyewear and faceshields
Optional earplug cord can be attached to earplug for additional security

Typical properties

Battery Life
Approx. 16 Hours
Battery Type
Lithium-Ion
Bluetooth
No
Brands
PELTOR™
Intrinsically Safe
No
Level Dependent Function for Ambient Listening
Yes
Noise Attenuating Headsets
Yes
Product Color
Black
Product Type
Earpiece
Recommen

3M™ PELTOR™ Yellow LEP-200 Replacement Earbud

3M Product Number LEP-200E 3M ID 7100141802 UPC 00093045938292

Details

Helps to provide hearing protection against continuous and impulse noises
Rechargeable Lithium Batteries for power management
Environmental microphones for level-dependent hearing protection and environmental awareness
Variety of replaceable communication eartips for comfort and various NRR levels

Typical properties

Battery Type
Lithium-Ion
Bluetooth
No
Brands
PELTOR™
Case Quantity
1 each
Intrinsically Safe
No
Level Dependent Function for Ambient Listening
Yes
Noise Attenuating Headsets
Yes
Product Color
Yellow
Product Type
Earpiece
eClass 14 Classi

3M™ PELTOR™ Replacement Earplug TEP-300L GE, Left, Gray, 20 ea/Case

3M Product Number TEP-300L GE 3M ID 7100227645 UPC 00638060429976

Details

Intuitive one-button operation turns unit on, off, and selects volume settings
Charging contacts recharge the unit while in the case
Internal earpiece Li-ion battery provides up to 10 hours of continuous operation when fully charged
Innovative design helps protect earpiece against water and dust ingress

Typical properties

Brands
PELTOR™
Case Quantity
20 ea / cs
Compatible With
TEP-300 Tactical Earplug
Product Color
Gray
Product Type
Replacement Earplug
eClass 14 Classification Group
40270191

3M™ PELTOR™ Black TEP-200 Replacement Earbud

3M Product Number TEP-200E 3M ID 7100141747 UPC 00093045938308

Details

Helps to provide hearing protection against continuous and impulse noises
Rechargeable Lithium Batteries for power management
Environmental microphones for level-dependent hearing protection and environmental awareness
Variety of replaceable communication eartips for comfort and various NRR levels

Typical properties

Battery Type
Lithium-Ion
Bluetooth
No
Brands
PELTOR™
Case Quantity
1 each
Intrinsically Safe
No
Level Dependent Function for Ambient Listening
Yes
Noise Attenuating Headsets
Yes
Product Color
Black
Product Type
Earpiece
Specifications Me

3M™ PELTOR™ Replacement Earplug TEP-300R GE, Right, Gray, 20 ea/Case

3M Product Number TEP-300R GE 3M ID 7100227648 UPC 00638060429969

Details

Intuitive one-button operation turns unit on, off, and selects volume settings
Charging contacts recharge the unit while in the case
Internal earpiece Li-ion battery provides up to 10 hours of continuous operation when fully charged
Innovative design helps protect earpiece against water and dust ingress

Typical properties

Battery Type
Rechargeable Li-ion Pack
Brands
PELTOR™
Case Quantity
20 ea / cs
Compatible With
TEP-300 Tactical Earplug
Product Color
Gray
Product Type
Replacement Earplug
eClass 14 Classification Group
40270191

3M™ PELTOR™ Replacement Earplug TEP-300L TN, Left, Tan, 20 ea/Case

3M Product Number TEP-300L TN 3M ID 7100227647 UPC 00638060429945

Details

Intuitive one-button operation turns unit on, off, and selects volume settings
Charging contacts recharge the unit while in the case
Internal earpiece Li-ion battery provides up to 10 hours of continuous operation when fully charged
Innovative design helps protect earpiece against water and dust ingress

Typical properties

Battery Type
Rechargeable Li-ion Pack
Brands
PELTOR™
Case Quantity
20 ea / cs
Compatible With
TEP-300 Tactical Earplug
Product Color
Tan
Product Type
Replacement Earplug
eClass 14 Classification Group
40270191

3M™ DBI-SALA® Confined Space UCT Tripod System

Details

- Telescoping adjustable locking legs
- Built-in pulley system
- Padded shoes and leg support chain
- Manually operated winch
- 6:1 gear ratio mechanical advantage winch
- Free-wheel mode available on winch
- 3-way emergency retrieval system
- Leg mount pulley system for secondary mechanical device (model 8003238)
- Quick connect winch and SRL mounting brackets (model 8005048)
- Equipped with pre-programmed RFID

Typical properties

- Brands
 - DBI-SALA®
- Carabiner/Hook Material
 - Zinc Plated Steel
- Connected Safety ID Equipped
 - Yes
- Install Type
 - Portable
- Lifeline Length (Imperial)
 - 50 ft, 60 ft, 120 ft
- Lifeline Length (Metric)
 - 15.2 m, 18.3 m, 36.6 m
- Lifeline Material
 - Galvanized Cab

Dimensions and Classifications

- Overall Height (Imperial)
 - 7 ft, 9 ft
- Overall Height (Metric)
 - 2.13 m, 2.7 m

3M™ DBI-SALA® Self-Rescue

Details

- Universal harness attachment
- EZ-Link D-ring for fast connections
- 50 ft. of 5.5 mm rope or 100 ft. of 5.5 mm rope
- Assisted-rescue ring for incapacitated user
- Sealed descent device and rope spool helps to extend longevity
- Molded padding provides durability and comfort
- Lightweight, low profile design
- Equipped with RFID tag for tracking
- Optional rescue pole available (model 8900299)

Typical properties

- Body Belt
- No
- Brands
- DBI-SALA®
- Case Quantity
- 1 per case
- CoWorker Controlled Ascent
- No
- CoWorker Controlled Descent
- Yes
- Confined Space
- No
- Connected Safety ID Equipped
- Yes
- Descent Type
- Vertical
- Dimensions
- 19.00x7.00x2.50in
- Install Type
- Port

Dimensions and Classifications

- Overall Length (Imperial)
- 50 ft, 100 ft
- Overall Length (Metric)
- 15 m, 30 m

3M™ DBI-SALA® Single Counterweight Plate For Roof Top Anchor 7200439, 45 lb

Part Number 7200439 3M Product Number 7200439 3M ID 7100311195

Details

Durable materials and hardware designed to help stand up to harsh working conditions
Compatible with various fall arrest systems, not compliant for use with Horizontal Lifelines
Suitable for use in general industrial and construction industries
Compact, lightweight design
Meets the requirements for 29 CFR OSHA 1910.140 and 29 CFR OSHA 1926.502
Features corrosion-resistant, steel and aluminum construction for durability
This safety equipment is designed for use with additional personal protective equipment (PPE)
Built-in carrying handle
20.3 kg (45 lb) iron weight with black e-coat
Portable, reusable and easily transported

Typical properties

Brands
DBI-SALA®
Case Quantity
1
Connected Safety ID Equipped
No
Dimensions
(17.50x14.70x1.00)in
Install Type
Reusable
Net Weight (Imperial)
45 lb
Net Weight (Metric)
20.4 kg
Product Color
Silver
Product Type
Single Counterweight Plate
R

3M™ Scotchlite™ Reflective Material 9910 Series

Details

3M™ Scotchlite™ Reflective Material is designed for enhancing visibility in low light and nighttime conditions
Suitable for applications that will be exposed to industrial laundering
Certified to the current editions of ANSI/ISEA 107 and CSA Z96 high visibility safety apparel standards
Heat transfer application

Typical properties

Adhesive
None
Attachment Type
Sew On
Backing
None
Backing Material
Polyester
Brands
Scotchlite™
Certified Performance Required
ANSI 107-2015, CSA Z95-2015, Oeko-Tex
Daytime Color
Silver
Dry-Cleaning Cycles at ANSI Certified Standards
50
Dr

Dimensions and Classifications

Overall Length (Imperial)
54.68 yd, 109.36 yd, 218.72 yd, 437.45 yd
Overall Length (Metric)
50 m, 100 m, 200 m, 400 m
Overall Width (Imperial)
0.5 in, 1 in, 1.18 in, 1.5 in, 2 in, 2.36 in, 3 in, 22.5 in, 36 in, 50 in
Overall Width (Metric)
12.7 mm,

3M™ PELTOR™ ALERT™ M2RX7A2-01, FM-Radio, Level Dependent Headset Headband, 10 Each/Case

3M Product Number M2RX7A2-01 3M ID 7000108376 UPC 07318640055421

Details

Occupational Hearing Protection helps protect you from potentially harmful workplace noise

Built-in FM Radio for Listening Enjoyment

The level-dependent environmental listening allows ambient sounds to be heard at a level below 82dB

The 3.5 mm listen only stereo input (limited to 82 dB) connects to external devices (e.g. mobile phone, two-way radio, MP3 player) via the included 3.5 mm cable

User-friendly controls

Improves your ability to communicate with nearby colleagues without removing the headset

Improves your ability to hear without removing the headset

Typical properties

Attenuation Rating

26 dB

Audio Type

Music/Entertainment

Auxiliary Port

3.5mm

Battery Life

70 hours

Bluetooth

No

Brands

PELTOR™

Built In FM and or AM Radio

Yes

Built in 2-Way Radio

No

Case Quantity

1

Communication Direction

Listen-only

3M™ PELTOR™ ALERT™ M2RX7P3E2-01, FM-Radio, Level Dependent Headset Helmet Attached, 10 Each/Case

3M Product Number M2RX7P3E2-01 3M ID 7000108538 UPC 07318640063266

Details

Occupational Hearing Protection helps protect you from potentially harmful workplace noise

Built-in FM Radio for Listening Enjoyment

The level-dependent environmental listening allows ambient sounds to be heard at a level below 82dB

The 3.5 mm listen only stereo input (limited to 82 dB) connects to external devices (e.g. mobile phone, two-way radio, MP3 player) via the included 3.5 mm cable

User-friendly controls

Improves your ability to communicate with nearby colleagues without removing the headset

Improves your ability to hear without removing the headset

Typical properties

Attenuation Rating

25 dB

Audio Type

Music/Entertainment

Auxiliary Port

3.5mm

Battery Life

70 hours

Bluetooth

No

Brands

PELTOR™

Built In FM and or AM Radio

Yes

Built in 2-Way Radio

No

Case Quantity

1

Communication Direction

Listen-only

3M™ Comfort Grip Gloves - Cut-Resistant

Details

Excellent for jobs requiring dexterity when handling sharp parts

Typical applications include handling abrasive or sharp materials; forming, bending or machining sharp parts; cable pulling and wire handling; cable preparation

Available in two levels of protection: ANSI Cut Level 3, EN388 4544, and ANSI Cut Level 2, EN388 4343

Long-lasting, durable and washable

Typical properties

ANSI Cut Resistant Level

2, 3

EN 388 Mechanical Risk Designations

4343, 4544

Material

Polyethylene

Product Color

Gray

Product Type

Cut Resistant Work Gloves

Size

Large, Medium, X-Large

Units per Case

6.0

eClass 14 Classification Group

40280

3M™ E-A-R™ Classic Regular Earplugs

Details

Proprietary soft, slow-recovery foam is comfortable and helps with earplug fitting

Moisture-resistant foam

Compatible with the 3M™ E-A-Rfit™ Validation System

Dispenser packaging option available for uncorded earplugs

Features a Noise Reduction Rating (NRR)* of 29 dB

CSA Class AL

*U.S. EPA specifies the NRR as the measure of hearing protector noise reduction. However, 3M makes no warranties as to the suitability of the NRR for this purpose. 3M strongly recommends personal fit testing of hearing protectors. Research suggests that users may receive less noise reduction than indicated by the attenuation label value(s) on the packaging due to variation in fit, fitting skill, and motivation of the user. Refer to applicable regulations or guidance on how to adjust attenuation label values. It is recommended that the NRR be reduced by 50% to better estimate typical protection

Pillow pack option for storage of earplugs between uses

Typical properties

Attenuation Rating

33.0 Decibel, 29.0 Decibel, 29 dB

Banded

No

Case Quantity

360 Pair, 1500 Pair, 3000 Pair, 2000 Pair

Cord Color

Blue

Cord Material

Metal Detectable Cord, Vinyl

Cord Type

Metal Detectable Cord, None, Vinyl

Corded

No, Yes

Dielectr

3M™ DBI-SALA® Confined Space Tripod Pulley

Details

Pulley routes 3-way SRL with emergency retrieval or winch
Constructed with durable nylon and zinc-plated steel
Pin style lifeline retention system
Bolts to 3M™ DBI-SALA® Aluminum Tripod Leg
Accommodates lifelines up to 1/4 in. (6.3 mm)
Recommended for use in construction and general industrial applications

Typical properties

Case Quantity
1
Connected Safety ID Equipped
No
Dimensions
3.00x2.30x4.80in,4.00x3.00x4.70in
Install Type
Portable
Net Weight (Imperial)
2.3 lb, 2.4 lb
Net Weight (Metric)
1 kg, 1.1 kg
Product Color
Yellow Zinc
Product Series
Advanced™
Pro

3M™ DBI-SALA® Personal Self-Rescue Training Kit 3320053, 50 ft, Rope

3M ID 7100307008 UPC 00648250244593

Details

- Self-rescue training device allows up to 20 descents
- Universal harness attachment
- 50 ft. (15.2m) of 5.5 mm rope
- EZ-Link D-ring for fast connections
- Assisted-rescue ring for incapacitated user
- Molded padding provides durability and comfort
- Lightweight, low profile design
- Equipped with RFID tag for tracking
- Optional rescue pole available (model 8900299)
- Standard non-training 50 ft. (15.2m) and 100 ft. (30.5 m) models available

Typical properties

- Body Belt
- No
- Brands
- DBI-SALA®
- Case Quantity
- 1 per case
- CoWorker Controlled Ascent
- No
- CoWorker Controlled Descent
- Yes
- Confined Space
- No
- Connected Safety ID Equipped
- Yes
- Descent Type
- Vertical
- Dimensions
- 19.00x7.00x2.50in
- Install Type
- Port

Dimensions and Classifications

- Overall Length (Imperial)
- 50 ft
- Overall Length (Metric)
- 15 m

3M™ DBI-SALA® Roof Top Freestanding Counterweight Anchor 2100185, 1 EA

Part Number 2100185 3M Product Number 2100185 3M ID 7100218795

Details

Durable materials and hardware designed to help stand up to harsh working conditions
Compatible with various fall arrest systems, not compliant for use with Horizontal Lifelines
Suitable for use in general industrial and construction industries
Compact, lightweight design
Meets the requirements for 29 CFR OSHA 1910.140 and 29 CFR OSHA 1926.502
Features corrosion-resistant, steel and aluminum construction for durability
This safety equipment is designed for use with additional personal protective equipment (PPE)
Fall arrest rated for one worker. Lifting Kit Assembly Available Separately - 2104190
Portable, reusable and easily transported
Includes four PVC-coated base plates designed to offer increased durability, longevity, and slip resistance and sixteen, 45 lb. (20 kg) counterweights
Integrated swiveling eye on assembly rotates 360 degrees for improved range of movement for workers

Typical properties

Anchor Install Type
Reusable
Attachment Type
Counterweight
Brands
DBI-SALA®
Case Quantity
1
Connected Safety ID Equipped
No
Install Type
Reusable
Material
Steel
Product Color
Silver
Product Type
Roof Top Freestanding Counterweight Anchor

3M™ Scotchlite™ Reflective Material 8910 Series

Details

Wash Durability: Next generation wash longevity and brightness over the life of the material

Off-Angle Brightness: 32-angle table brightness compliance to help keep wearers visible from many angles

Independently certified to OEKO-TEX® Standard 100

Use Performance: Performance to industry standard testing for abrasion, flexing, cold-folding and rainfall

Product Authentication: 3M™ Scotchlite™ Reflective Material logo printed on backside of fabric

Typical properties

Adhesive

None

Attachment Type

Sew On

Backing Material

Polyester/Cotton

Brands

Scotchlite™

Configurable

No, Yes

Daytime Color

Silver

Dry-Cleaning Cycles at ANSI Certified Standards

30

Dry-Cleaning Cycles at ISO Certified Standards

30

Flame

Dimensions and Classifications

Overall Length (Imperial)

54.68 yd, 109.36 yd, 218.72 yd, 218.723 yd, 1000 yd

Overall Length (Metric)

50 m, 100 m, 200 m, 914.4 m

Overall Width (Imperial)

0.5 in, 1 in, 1.5 in, 2 in, 10 in, 42.07 in, 50 in

Overall Width (Metric)

12.7 mm, 25.4 mm, 3

3M™ Overshoe 442

3M ID B00014983

Details

Footwear protection designed for workers in painting, general industry, and more
Constructed from microporous PE laminate material for enhanced protection
Protective overshoe covers feature anti-static treatment to help reduce static build-up
Universal size with elastic at the top to help provide a good fit
Sole and upper constructed from same PE laminate material
Shoe protection designed to be used with all 3M™ Coveralls (sold separately)
150 pairs included in each case

3M™ PELTOR™ WorkTunes™ Pro AM/FM Radio Headset, Black, Headband

3M Product Number HRXS221A-NA 3M ID 7100089367 UPC 00078371670863

Details

Professional-Quality Hearing Protection (26dB NRR)

AM/FM Radio headset with built in antenna to prevent snagging on equipment

Store up to 5 stations so you don't miss your favorite station

3.5 mm listen only stereo input (limited to 82 dB) for connection to external devices (e.g. cell phone, two-way radio, Ipod)

Auto power off, the headset will turn off after 4 hrs of non-use to save battery

Audible Low-battery warning so you know when to change your batteries

To reduce the corrosion caused by sweat, the electronics are located in separate compartment of the cup

Available in both headband and hard hat attached versions (black)

Typical properties

Attenuation Rating

26 dB

Audio Type

Music/Entertainment

Auxiliary Port

3.5mm

Battery Life

40 Hours

Bluetooth

No

Brands

PELTOR™

Built In FM and or AM Radio

Yes

Built in 2-Way Radio

No

Case Quantity

1

Communication Direction

Listen-only

3M™ PELTOR™ WorkTunes™ Pro AM/FM Radio Headset, Black, Hard Hat Attached

3M Product Number HRXS221P3E-NA 3M ID 7100089369 UPC 00078371670887

Details

Professional-Quality Hearing Protection (23db NRR)

AM/FM Radio headset with built in antenna to prevent snagging on equipment

Store up to 5 stations so you don't miss your favorite station

3.5 mm listen only stereo input (limited to 82 dB) for connection to external devices (e.g. cell phone, two-way radio, Ipod)

Auto power off, the headset will turn off after 4 hrs of non-use to save battery

Low-battery warning at low battery level

To reduce the corrosion caused by sweat, the electronics are located in separate compartment of the cup

Available in both headband and hard hat attached versions (black)

Typical properties

Attenuation Rating

23 dB,22 dB

Audio Type

Music/Entertainment

Auxiliary Port

3.5mm

Battery Life

40 Hours

Bluetooth

No

Brands

PELTOR™

Built In FM and or AM Radio

Yes

Built in 2-Way Radio

No

Case Quantity

1

Communication Direction

Listen-

3M™ E-A-Rsoft™ FX Earplugs

Details

Features a bell shape made of soft, slow-recovery foam for a comfortable fit

Flared end helps with an easier removal

Compatible with the 3M™ E-A-Rfit™ Validation System

3M's maximum noise reduction rating (NRR)*: 33 dB

Dispenser packaging option available for uncorded earplugs

CSA Class AL

*U.S. EPA specifies the NRR as the measure of hearing protector noise reduction. However, 3M makes no warranties as to the suitability of the NRR for this purpose. 3M strongly recommends personal fit testing of hearing protectors. Research suggests that users may receive less noise reduction than indicated by the attenuation label value(s) on the packaging due to variation in fit, fitting skill, and motivation of the user. Refer to applicable regulations or guidance on how to adjust attenuation label values. It is recommended that the NRR be reduced by 50% to better estimate typical protection

Typical properties

Attenuation Rating

33.0 Decibel

Banded

No

Brands

E-A-R™

Case Quantity

1000 Pair, 2000 Pair, 500 Pair

Cord Color

Orange

Cord Type

None, Vinyl

Corded

No, Yes

Dielectric

No

Dispenser Available

No

Earplug Material

Foam, Polyurethane

Earplug

3M™ DBI-SALA® Confined Space Tripod

Details

Telescoping adjustable locking legs

Mechanical devices can support up to three winches or Self-Retracting Lines (SRLs) for complete flexibility

Quick-connect bracket allows fast and easy attachment of mechanical devices

Safety chain provides added support and strength for demanding confined space applications

Top mounted pulley system mount up to three pulleys to route mechanical device lifelines for smooth operation

5,000 lb (22 kN) anchor point for secondary fall arrest system

Lightweight yet durable aluminum construction for ease-of-use and longevity

Typical properties

Brands

DBI-SALA®

Connected Safety ID Equipped

Yes

Install Type

Portable

Maximum Base Radius (Imperial)

3.66 ft

Maximum Base Radius (Metric)

1.11 m

Maximum Height (Imperial)

7 ft, 9 ft

Maximum Height (Metric)

2.13 m, 2.74 m

Minimum Base Radiu

Dimensions and Classifications

Overall Length (Imperial)

7 ft, 9 ft

3M™ DBI-SALA® Rollgliss™ R550 Rescue and Descent Device Humidity Case 9508289, Up To 500 ft

Part Number 9508289 3M Product Number 9508289 3M ID 7100246539

Details

Humidity-resistant storage case for Rollgliss™ R550 rescue and positioning systems

Heavy-duty and extremely durable polyethylene case

Extends storage life to 10 years

Fits up to a 500 ft. (153 m) system length

Built-in humidity indicator allows workers to check moisture content without opening case

Outside dimensions: 22 in. (55.9 cm) x 18 in. (45.7 cm) x 13 in. (33 cm)

Recommended for use in utilities, wind energy, and general industrial applications

Typical properties

Brands

DBI-SALA®

Case Quantity

1

CoWorker Controlled Ascent

No

CoWorker Controlled Descent

No

Connected Safety ID Equipped

No

Dimensions

(22.00x18.00x13.00)in

Net Weight (Imperial)

16.7 lb

Net Weight (Metric)

7.6 kg

Product Color

Yellow

3M™ DBI-SALA® Adjustable Rope Positioning Lanyard 1232210, 1/2 in Polyester, 6 ft

Part Number 1232210 3M Product Number 1232210 3M ID 7012817068

Details

The web, rope and chain positioning lanyards are available in a variety of lengths
User friendly self locking snap hooks at each end
Equipped with 3M™ Connected Safety ID (CSID)
User friendly self locking snap hooks at each end
Equipped with 3M™ Connected Safety ID (CSID)
Equipped with 3M™ Connected Safety ID (CSID)

Typical properties

Anchor Connection Type
Snap Hook
Anchor Hook Material
Zinc Plated Steel
Brands
DBI-SALA®
Case Quantity
1
Connected Safety ID Equipped
Yes
Energy Absorber Class
None
Harness Connection Hook Material
Zinc Plated Steel
Harness Connection Type

Dimensions and Classifications

Overall Length (Imperial)
6 ft

3M™ DBI-SALA® Adjustable Web Positioning Lanyard 1231012, 4 ft

Part Number 1231012 3M Product Number 1231012 3M ID 7012816998

Details

The web, rope and chain positioning lanyards are available in a variety of lengths
User friendly self locking snap hooks at each end
Equipped with 3M™ Connected Safety ID (CSID)
User friendly self locking snap hooks at each end
Equipped with 3M™ Connected Safety ID (CSID)
Equipped with 3M™ Connected Safety ID (CSID)

Typical properties

Anchor Connection Type
Snap Hook
Anchor Hook Material
Zinc Plated Steel
Brands
DBI-SALA®
Case Quantity
1
Connected Safety ID Equipped
Yes
Energy Absorber Class
None
Harness Connection Hook Material
Zinc Plated Steel
Harness Connection Type

Dimensions and Classifications

Overall Length (Imperial)
4 ft

3M™ DBI-SALA® Adjustable Web Positioning Lanyard 1231016, 6 ft

Part Number 1231016 3M Product Number 1231016 3M ID 7100241701

Details

The web, rope and chain positioning lanyards are available in a variety of lengths
User friendly self locking snap hooks at each end
Equipped with 3M™ Connected Safety ID (CSID)
User friendly self locking snap hooks at each end
Equipped with 3M™ Connected Safety ID (CSID)
Equipped with 3M™ Connected Safety ID (CSID)

Typical properties

Anchor Connection Type
Snap Hook
Anchor Hook Material
Zinc Plated Steel
Brands
DBI-SALA®
Case Quantity
1
Connected Safety ID Equipped
Yes
Energy Absorber Class
None
Harness Connection Hook Material
Zinc Plated Steel
Harness Connection Type

Dimensions and Classifications

Overall Length (Imperial)
6 ft

3M™ DBI-SALA® Cable Horizontal Lifeline System

Details

Galvanized cable lifeline is available in multiple lengths to suit your needs
Metal Energy Absorbers help limit lifeline tension forces to protect the structure and minimize required fall clearance
Built-in, turnbuckle tensioner helps your worker tension the system to the required levels
All-metal design can be left in place for extended periods of time based on the work environment
This horizontal lifeline system is intended for use with a fall protection harness and lanyard or SRL
Accommodates two 310 lbs (140.6 kg) workers per span, up to 6 workers per system with multiple spans. Additional Metal Energy Absorbers may be required
Equipped with RFID
Wedge Grip termination device provides quicker setup and modifications to system length changes

Typical properties

Case Quantity
1
Connected Safety ID Equipped
Yes
Install Type
Temporary/Portable
Lifeline Length (Imperial)
20 ft, 30 ft, 40 ft, 50 ft, 60 ft, 70 ft, 80 ft, 90 ft, 100 ft
Lifeline Length (Metric)
6.09 m, 9.14 m, 12.19 m, 15.23 m, 18.28 m, 21.33 m

Dimensions and Classifications

Overall Length (Imperial)
20 ft, 30 ft, 40 ft, 50 ft, 60 ft, 70 ft, 80 ft, 90 ft, 100 ft
Overall Length (Metric)
6 m, 9 m, 12 m, 15 m, 18 m, 21 m, 30 m

3M™ V4 Series Faceshields & Visors

Details

System gives users a choice of faceshield materials, sizes, coverage, and tints for task specific requirements

Compatible with additional 3M Personal Protective Equipment

Requires P3EV/2-10P Adapter, 3M Hard Hat Attached Earmuffs or Hard Hat Attached 3M PELTOR(TM) Advanced Hearing Protection

Meets the requirements of ANSI Z87.1 for Occupational and Educational Personal Eye and Face Protection Devices and ANSI Z89.1 for Industrial Head Protection

Protective eyewear should be worn under faceshields at all times

Typical properties

Case Quantity

1,10

For Use With

3M™ Peltor™ Cap-mounted Earmuffs, 3M™ Peltor™ Hard Hat Adapter P3EV/2, 3M™ Peltor™ Muffs, Earmuffs, Hard Hats

Product Type

Faceshield, Forestry Combination

Recommended Application

Assembly, Cleaning, Demolition, Elec

Dimensions and Classifications

Overall Height (Imperial)

6.5 in, 7 in

Overall Height (Metric)

16.5 cm, 18 cm

Overall Length (Imperial)

6.5 in, 11.8 in, 12.4 in, 12.98 in

Overall Length (Metric)

16.51 cm, 29.97 cm, 31.5 cm, 32.97 cm

Overall Width (Imperial)

5.5 in, 7 in, 9.4 in

3M™ DBI-SALA® Flexiguard™ Freestanding Ladder Adjustable Height Access Anchor System 8567717, 2 User, 14.5 - 23 ft

Part Number 8517717 3M Product Number 8517717 3M ID 7012755906

Details

Freestanding Ladder System

Platform height ranges from 10.75 ft. (3.28 m) to 30.8 ft (9.39 m) available over various models

Manual height adjustment via winch assembly

Multiple height adjustment ranges available

Fall arrest anchorage for accessing ladder

Leveling jacks included

Requires minimal clearance away from the work area/ object

Different models available to suit customer requirements

Aluminum and steel construction

Visual level indicators

Custom designs available

Specialized installation and training available

Typical properties

Brands

DBI-SALA®

Case Quantity

1

Connected Safety ID Equipped

Yes

Install Type

Temporary/Portable

Maximum Height (Imperial)

23 ft

Maximum Height (Metric)

7.1 m

Maximum Number of Users

One, Two

Minimum Height (Imperial)

14.5 ft

Minimum Height (Metric)

Dimensions and Classifications

Overall Width (Imperial)

17.02 ft

Overall Width (Metric)

5.19 m

3M™ DBI-SALA® Flexiguard™ Freestanding Ladder Adjustable Height Access Anchor System 8567719, 2 User, 18.5 – 31 ft.

Part Number 8517719 3M Product Number 8517719 3M ID 7012755908

Details

Freestanding Ladder System

Platform height ranges from 10.75 ft. (3.28 m) to 30.8 ft (9.39 m) available over various models

Manual height adjustment via winch assembly

Multiple height adjustment ranges available

Fall arrest anchorage for accessing ladder

Leveling jacks included

Requires minimal clearance away from the work area/ object

Different models available to suit customer requirements

Aluminum and steel construction

Visual level indicators

Custom designs available

Specialized installation and training available

Typical properties

Brands

DBI-SALA®

Case Quantity

1

Connected Safety ID Equipped

Yes

Install Type

Temporary/Portable

Maximum Height (Imperial)

31 ft

Maximum Height (Metric)

9.449 m

Maximum Number of Users

Two

Minimum Height (Imperial)

18.25 ft

Minimum Height

3M™ E-A-RTEMP™ 13A Foam Temporary Earmold beige foam eartip with pre-bent tube 420-2060, 25 EA/Case

3M Product Number 420-2060 3M ID 7010342198 UPC 10080529510072

Details

3M PSD products are for occupational use only

*The NRR may overestimate the hearing protection provided during typical use

Typical properties

Brands

E-A-R™

Case Quantity

25

Hearing Protection Style

Probed for Fit Testing

Product Series

E-A-RTEMP

Product Type

Foam Eartip

Shape

Cylinder

3M™ PELTOR™ X4 Earmuffs

Details

Noise Reduction Rating (NRR) between 25–27 dB (depending on the attachment type)

Low-profile cup design for improved compatibility with other personal protection equipment (PPE)

High ratio of NRR to earcup depth

3M™ E-A-Rfit™ Dual-Ear Validation System testable

Slow-recovery, high-density foam

Replaceable ear cushions and foam liners (hygiene kit HYX4)

Typical properties

Attenuation Rating

25.0 Decibel, 26.0 Decibel, 27.0 Decibel

Attenuation Rating (SNR)

27 Decibel

Battery Type

Turbo: Lithium-ion. ADF: Lithium 3V

Bluetooth

No

Brands

PELTOR™

Case Quantity

1, 10

Corded

No

Dielectric

No, Yes

Earmuff Style

Behin

3M™ E-A-R™ E-Z-Fit™ Earplugs 312-1208, Uncorded, PolyBag, 2000 Pair/Case

3M Product Number 312-1208 3M ID 7100007118 UPC 10080529120073

Details

Poly bag keeps each pair of earplugs clean before use

Ideal for smaller earcanals

Noise Reduction Rating (NRR)* 28 dB. CSA Class AL

Test compatible with 3M™ E-A-Rfit™ Validation System

Noise reduction rating (NRR) 28 dB CSA Class AL

Typical properties

Attenuation Rating

28.0 Decibel

Banded

No

Brands

E-A-R™

Case Quantity

2000

Cord Type

None

Corded

No

Dielectric

No

Dispenser Available

No

Earplug Material

Foam

Earplug Shape

Bell

Earplug Size

Small

Electrically Insulated

Yes

Hearing

3M™ E-A-R™ E-Z-Fit™ Earplugs 312-1222, Corded, Poly Bag, 2000 Pair/Case

3M Product Number 312-1222 3M ID 7000127211 UPC 10080529120165

Details

Bell-shaped earplugs fit comfortably in the ear to help protect your hearing
Rolls down easily and then expands to block noise
Low pressure foam conforms to the shape of the earcanal for a snug fit
Smaller size earplug suitable for smaller earcanals
Noise reduction rating (NRR) 28 dB CSA Class AL
Cord allows earplugs to be stored conveniently around the neck in between uses

Typical properties

Attenuation Rating
28.0 Decibel
Banded
No
Brands
E-A-R™
Case Quantity
2000
Cord Color
Blue
Cord Material
Vinyl
Cord Type
Vinyl
Corded
Yes
Dielectric
No
Dispenser Available
No
Earplug Color
Yellow
Earplug Material
Foam
Earplug Shape

3M™ Tri-Flange™ Earplugs

Details

Triple-flange design to help fit a variety of ear canal shapes and sizes
Plastic grips help insert ear tips and keep them clean, even when hands or gloves are dirty

Noise reduction rating (NRR)*: 26 dB

Reusable earplugs made with materials that can be washed

Corded only with option of vinyl or cloth material

CSA Class AL

*U.S. EPA specifies the NRR as the measure of hearing protector noise reduction. However, 3M makes no warranties as to the suitability of the NRR for this purpose. 3M strongly recommends personal fit testing of hearing protectors. Research suggests that users may receive less noise reduction than indicated by the attenuation label value(s) on the packaging due to variation in fit, fitting skill, and motivation of the user. Refer to applicable regulations or guidance on how to adjust attenuation label values. It is recommended that the NRR be reduced by 50% to better estimate typical protection

Typical properties

Attenuation Rating

26.0 Decibel

Banded

No

Brands

3M™

Case Quantity

400 Pair

Cord Color

Yellow

Cord Material

Cloth

Cord Type

Vinyl

Corded

Yes

Dielectric

No

Dispenser Available

No

Earplug Color

Clear

Earplug Material

Elastomeric Polym

3M™ Welding Battery Chargers

Details

Ensures your 3M™ Adflo™ Powered Air Purifying Respirator stays fully-charged, safe and ready to use

Charges 3M™ Adflo™ Li-ion batteries

Replaces worn or damaged chargers

Increase the service life of your equipment by checking it regularly

Typical properties

Battery Type

Lithium-Ion, PAPR: Lithium ion

Brands

3M™

Case Quantity

1

Compatible With

3M™ Adflo™ PAPR, 3M™ Adflo™ PAPR Batteries & Charger

Features

Respiratory Spare Part

Intrinsically Safe

No

Product Series

9100 FX-Air, 9100 MP, 9100-Air, A

3M™ Air Deflector Gasket W-2925, 1 EA/Case

3M Product Number W-2925 3M ID 7100061977 UPC 00051138159061

Details

Used with the 3M™ Compressed Air Filter and Regulator Panel W-2806

Typical properties

Brands

3M™

CFM Capacity per Minute

100 CFM, 50 CFM

Case Quantity

1/pack

Compatible With

3M™ W-2806 Filtration Panel

Pressure Type

High

Product Color

Black

Product Series

Supplied Air

Product Type

Gasket

Supplied Air Respirator Style

W-Ser

3M™ Gasket 061-35-04R01 1 EA/Case

3M Product Number 061-35-04R01 3M ID 7000126354 UPC 00051138722616

Details

Replacement part

Used on 3M™ Breathe Easy™, Powerflow™ and Supplied Air Systems

Typical properties

Brands

3M™

Case Quantity

1/pack

Compatible With

3M™ Breathe Easy™ PAPR, 3M™ Powerflow™ PAPR

Headgear Type

Full Facepiece

Product Color

Gray

Product Series

Powerflow

Product Type

Gasket

3M™ Adflo™ Rubber Breathing Tube Foam Gasket 15-0099-11, 1 EA/Case

3M Product Number 15-0099-11 3M ID 7100077599 UPC 00051131932524

Details

Foam Gasket
Replacement Part

Typical properties

Brands

Adflo™

Case Quantity

1

Compatible With

3M™ Adflo™ PAPR

Features

Respiratory Accessory

Product Type

Breathing Tube

Purpose

Exclude

Recommended Application

Assembly, Facility Maintenance, Grinding, Machine Operation, Sanding, Welding
Re

3M™ TR-654 Replacement Gaskets for TR-653 Cleaning and Storage Kit, 20/Bag, 4 Bags EA/Case

3M ID 7100134768 UPC 00051131373846

Details

Enables simple maintenance of TR-653 cleaning and storage plugs
Reduces maintenance costs by enabling extended use of TR-653 cleaning and storage plugs
Convenient package

Typical properties

Brands

Versaflo™

Case Quantity

10/pack

Compatible With

3M™ Versaflo™ TR-600 Series PAPR

Product Color

Gray

Product Series

TR-600

Product Type

Seals

Recommended Application

Assembly & Mechanical, Construction, Facility Maintenance, Metal Proce

3M™ Versaflo™ Replacement Visor Gasket M-921/37321(AAD), 5 EA/Case

3M Product Number M-921 3M ID 7000127688 UPC 00051131373211

Details

Replacement part for all 3M™ Versaflo™ M-Series products

Typical properties

Brands
Versaflo™
Case Quantity
5
Compatible With
3M™ Versaflo™ M-Series Helmet
Headgear Type
Headcover
High Heat
No
Product Color
Black
Product Series
M-Series
Product Type
Faceshield
Recommended Industry
Marine

3M™ Versaflo™ Replacement Jaw Gasket M-441, for M-400 Helmets, 1 EA/Case

3M Product Number M-441 3M ID 7000127682

Details

Replacement part for 3M™ Versaflo™ M-400 Series Helmets

Typical properties

Brands

Versaflo™

Case Quantity

1

Compatible With

3M™ Versaflo™ M-407 Helmet

Headgear Type

Helmet with Faceshield

High Heat

No

Product Color

Black

Product Series

M-Series

Product Type

Headgear

3M™ Bowl Gasket W-2921, 1 EA/Case

Part Number 15552 3M Product Number W-2921 3M ID 7000130674

Details

Used with the 3M™ Compressed Air Filter and Regulator Panel W-2806

Typical properties

Brands

3M™

CFM Capacity per Minute

100 CFM, 50 CFM

Case Quantity

1/pack

Compatible With

3M™ W-2806 Filtration Panel

Pressure Type

High

Product Color

Black

Product Series

Supplied Air

Product Type

Gasket

Supplied Air Respirator Style

W-Ser

3M™ Adapter H-120 4/case

3M Product Number H-120 3M ID 7000127718 UPC 00051131173828

Details

The 3M™ H-120 Adapter allows H-Series Hoods to connect to 3M™ Versaflo™ breathing tubes
It consists of a hood connector and a clip

Typical properties

Brands

3M™

Case Quantity

4/case

Compatible With

3M™ H-Series Headgear, 3M™ Versaflo™ Breathing Tube

Headgear Type

Hood

Product Series

H-Series

Product Type

Adapter

Recommended Application

Cleaning, Cutting, Drilling, General Maintenance, Grin

3M™ Adapter 529-04-50, 110-120 VAC, 1 EA/Case

3M Product Number 529-04-50 3M ID 7000131705 UPC 00051138720131

Details

Used with the carbon monoxide monitor (CO) in the 3M™ Portable Compressed Air Filter and Regulator Panel 256-02-00 and 256-02-01 as well as the 3M™ Retrofit CO Monitor Kit W-2808

Typical properties

Brands

3M™

CFM Capacity per Minute

100 CFM, 50 CFM

Case Quantity

1/case

Compatible With

3M™ Retrofit CO Monitor Kit W-2808

Product Color

Black

Product Series

Supplied Air

Product Type

Adapter

Supplied Air Respirator Style

MST Portable and F

3M™ Adflo™ Leather Belt Front Replacement 15-0099-06, 1 EA/Case

3M Product Number 15-0099-06 3M ID 7000126725 UPC 00051131925908

Details

Leather front for belt
Replacement Part

Typical properties

Brands

Adflo™

Case Quantity

1

Compatible Respirator

3M Adflo Powered Air Purifying Respirator

Features

Respiratory Accessory

Product Series

Adflo

Product Type

Belt

Recommended Application

Assembly, Facility Maintenance, Grinding, Machine Oper

3M™ Speedglas™ 9100 Welding Headband 06-0400-52-B, Left and Right Side Pivot Mechanism, 5 EA/Case

3M Product Number 06-0400-52-B 3M ID 7000127154 UPC 50051135893987

Details

Headband Pivot Mechanism
Replacement Part

Typical properties

Brands

Speedglas™

Case Quantity

5

Compatible Welding Helmet

9100 Series

Features

9100 Series Accessory

For Use With

3M™ Speedglas™ 9100 Welding Helmets, 3M™ Speedglas™ 9100FX-Air

Welding Helmets

Includes

Left and Right Side Parts

Product Color

3M™ Speedglas™ Pivot Cover Plate Kit 06-0116-00QR, 1 EA/Case

3M Product Number 06-0116-00QR 3M ID 7100031973 UPC 00051141563695

Details

Pivot Cover Plate Kit
Replacement Part
9100 QR

Typical properties

Brands
Speedglas™
Case Quantity
1
Compatible Welding Helmet
9100 QR Welding Helmets
Product Color
Black
Product Series
100, 9100
Recommended Application
Assembly, Facility Maintenance, Grinding, Machine Operation, Sanding, Welding
Recommended

3M™ Speedglas™ G5-02 Headband Pivot Mechanism 08-0400-52, Left and Right Side, 1 ea

Part Number 08-0400-52 3M Product Number 08-0400-52 3M ID 7100239940

Details

Replaces worn or damaged assembly parts of 3M™ Speedglas™ Headband G5-02

Designed for the headband of 3M™ Speedglas™ Welding Helmet G5-02

Ensures you get the correct level of comfort and protection

For maximum safety and comfort make it a habit to check your equipment regularly

Typical properties

Brands

Speedglas™

Case Quantity

1/Case

Compatible Welding Helmet

G5-02 Welding Helmets

For Use With

G5-02 Welding Helmets

Product Series

G5

Product Type

Headband

Recommended Application

Welding

Recommended Industry

Construction, General Man

3M™ Versaflo™ M-Series Helmet Welding Knob and Pivot Kit M-146SG, 1 EA/Case

3M Product Number M-146SG 3M ID 7100168648 UPC 00076308942779

Details

Weld shield can be installed with common hand tools
Available as replacement parts
User is able to lift weld shield independently from respiratory visor
Used for attaching Speedglas™ M-153SG attachment to Versaflo™ M-400 Series helmets

Typical properties

Brands
Versaflo™
Compatible Respirator
M-Series
Compatible Welding Helmet
M-Series
For Use With
3M™ Versaflo™ Respiratory M-Series Helmet Assemblies
Headgear Type
No Headgear Included
Intrinsically Safe
N/A
Net Weight (Imperial)
0.2 lb
Net W

3M™ Speedglas™ Pivot Kit 27-0099-52, for 9100MP Welding Helmets, 1 EA/Case

3M Product Number 27-0099-52 3M ID 7000128223 UPC 00051141558127

Details

Pivot Kit
Replacement Part
9100 MP

Typical properties

Brands
Speedglas™
Case Quantity
1
Compatible Welding Helmet
9100 MP Welding Helmets
Features
Respiratory Accessory
For Use With
3M™ Speedglas™ 9100MP Welding Helmets
Product Series
9100, 9100 MP, 9100-Air
Product Type
Headband
Recommended Ap

**3M™ Adflo™ Powered Air Purifying Respirator HE System w 3M™
Speedglas™
Welding Helmet 9100 FX-Air, 36-1101-30iSW, 1 EA/CASE**

3M ID 7100200572 UPC 00076308943820

Details

Complete 3M™ Adflo™ System
Includes a 3M™ Speedglas™ 9100 FX-Air Welding Helmet
Features a flip-up solution for grinding and prep work
Ergonomic, adjustable headband
Delivers comfort, helmet stability, and good weight distribution

Typical properties

ADF Model
9100XXi
ADF Shade Range
Variable 5, 8-13
ADF Viewing Area (hwxw)
2.8x4.2in
Air Source
PAPR
Battery Life
ADF: up to 1800 Hours, Adflo - 10 Hours
Battery Type
PAPR: Lithium ion
Brands
Adflo™
Cartridge or Filter Included
HE Filter
Co

3M™ Speedglas™ Welding Helmet SL, Welding Safety 05-0013-00 1 EA/Case

3M Product Number 05-0013-00 3M ID 7010384820 UPC 00051141562568

Details

Lightweight face and eye protection for a range of welding applications
Narrow helmet design
Welders working in areas with overhead hazards can now benefit from the safety helmet adapter for 3M™ Speedglas™ Welding Helmet SL
Weighs a total of just 375g – including the Auto-Darkening Lens
Five adjustable dark shades 8-12 and a light shade of 3
Adjustable headband with smooth ratchet
Grab and Go: A motion sensor automatically turns ON the welding lens when you pick up the helmet
Appropriate for most arc welding processes, such as MMA, MIG/MAG, TIG and plasma welding. Not suitable for grinding

Typical properties

ADF Model
None
Brands
Speedglas™
Comes with Auto-Darkening Filter (ADF)
No
Front Panel Included
Yes
Headband Included
No
Lens Type
No Lens
Side Windows
No

3M™ DBI-SALA® Cable Tie-Off Adaptor

Details

Portable and reusable
Meets the requirements for ANSI/ASSP Z359.18, 29 CFR OSHA 1910.140 and 29 CFR OSHA 1926.502
Recommended for use in multiple industries including construction, mining, and oil and gas
Compact and lightweight design
High strength steel O-ring hardware
Variable length pass-thru type tie off adaptor
Durable 3/8 in. (9.5 mm) 7x19 stainless steel cable construction

Typical properties

Anchor Install Type
Reusable
Attachment Type
Pass-through/Choker
Case Quantity
1
Connected Safety ID Equipped
No
Install Type
Reusable
Material
Stainless Steel
Product Color
Silver
Product Series
None
Product Type
Cable Tie-off Adapter
R

Dimensions and Classifications

Overall Length (Imperial)
2 ft, 3 ft, 4 ft, 5 ft, 6 ft, 7 ft, 10 ft, 12 ft, 20 ft, 29 ft

3M™ DBI-SALA® Fixed Beam Anchor 2108407, 1 EA

Part Number 2108407 3M Product Number 2108407 3M ID 7100207456

Details

Compatible with various fall protection systems
Compact, lightweight design
Ideal for use with personal fall arrest systems with self-retracting lifelines
Recommended for use in the construction, general industrial, mining, oil and gas, transportation, utilities, and wind energy industries
Portable and reusable
Corrosion-resistant construction for durability
This safety equipment is designed for use with additional personal protective equipment (PPE)
Fixed beam anchor fits variable width I-beams
Attach in any orientation or direction with detent style attachment with built-in tightening handle
High strength steel and aluminum construction with Swiveling D-ring tie-off point
ANSI / ASSP Z359.18 and meets the requirements of 29 CFR OSHA 1910.140, OSHA 1926

Typical properties

Anchor Install Type
Reusable
Attachment Type
Clamp
Brands
DBI-SALA®
Case Quantity
1
Connected Safety ID Equipped
Yes
Dimensions
26.00x2.50x4.00in
Fits Ibeam Flange Width
2-1/2 to 18 in. (6.3-45.7cm)
Install Type
Reusable
Material
Zinc Pla

3M™ DBI-SALA® Fixed Beam Anchor 2108408, Fits 2.5 - 24 in Wide, 1.5 in Thick

Part Number 2108408 3M Product Number 2108408 3M ID 7100241958

Details

Compatible with various fall protection systems
Compact, lightweight design
Ideal for use with personal fall arrest systems with self-retracting lifelines
Recommended for use in the construction, general industrial, mining, oil and gas, transportation, utilities, and wind energy industries
Portable and reusable
Corrosion-resistant construction for durability
This safety equipment is designed for use with additional personal protective equipment (PPE)
Fixed beam anchor fits variable width I-beams
Attach in any orientation or direction with detent style attachment with built-in tightening handle
High strength steel and aluminum construction with Swiveling D-ring tie-off point
ANSI / ASSP Z359.18 and meets the requirements of 29 CFR OSHA 1910.140, OSHA 1926

Typical properties

Anchor Install Type
Reusable
Attachment Type
Clamp
Brands
DBI-SALA®
Case Quantity
1
Connected Safety ID Equipped
Yes
Dimensions
32.00x2.50x4.00in
Fits Ibeam Flange Width
2-1/2 to 24 in. (6.3-61 cm)
Install Type
Reusable
Material
Zinc Plate

3M™ DBI-SALA® Fixed Beam Anchor 2108410, Fits 12 - 36 in Wide, 2.5 in Thick

Part Number 2108410 3M Product Number 2108410 3M ID 7100260183

Details

Compatible with various fall protection systems
Compact, lightweight design
Ideal for use with personal fall arrest systems with self-retracting lifelines
Recommended for use in the construction, general industrial, mining, oil and gas, transportation, utilities, and wind energy industries
Portable and reusable
Corrosion-resistant construction for durability
This safety equipment is designed for use with additional personal protective equipment (PPE)
Fixed beam anchor fits variable width I-beams
Attach in any orientation or direction with detent style attachment with built-in tightening handle
High strength steel and aluminum construction with Swiveling D-ring tie-off point
ANSI / ASSP Z359.18 and meets the requirements of 29 CFR OSHA 1910.140, OSHA 1926

Typical properties

Anchor Install Type
Reusable
Attachment Type
Clamp
Brands
DBI-SALA®
Case Quantity
1
Connected Safety ID Equipped
Yes
Dimensions
45.00x2.50x5.00in
Fits Ibeam Flange Width
12 to 36 in. (30.5-91.4cm)
Install Type
Reusable
Material
Zinc Plate

3M™ DBI-SALA® Sliding Beam Anchor

Details

Compatible with various fall protection systems
Compact, lightweight design
Ideal for use with personal fall arrest systems with self-retracting lifelines
Recommended for use in the construction, general industrial, mining, oil and gas, transportation, utilities, and wind energy industries
Portable and reusable
Corrosion-resistant construction for durability
This safety equipment is designed for use with additional personal protective equipment (PPE)
Hands-free mobility and a 360-degree swiveling D-ring, which helps optimize the user's work while on a beam
Models designed to fit a variety of beam sizes
Visible adjustability dual-ratchet buttons accessible above the beam
Snap-in design of wear pads allows for quick replacement in the field

Typical properties

Anchor Hook Material
Metal
Anchor Hook Material
Metal
Anchor Install Type
Reusable
Case Quantity
1 EA
Connected Safety ID Equipped
No
For Use With
3M™ DBI-SALA® SecuraSpan™ I-Beam System
Housing Material
Aluminum & Stainless Steel
Housing Ty

3M™ Speedglas™ Fresh-Air III V-100 Vortex Air-Cooling Valve Supplied Air System with 3M™ Speedglas™ 9100 MP Welding Helmet

Details

3M™ Speedglas™ Welding Helmet 9100 MP with 3M™ Speedglas™ Fresh-Air III V-100 Vortex Air-Cooling Valve Supplied Air System
Belt-mounted V-100 air-cooling valve lowers headgear temperature by up to 50°F (28°C)
APF of 25 helps reduce exposure to particles and vapors
Side windows allow for better peripheral vision
Requires grade D breathable air source
Applications include assembly, assembly and mechanical, facility maintenance, grinding, machine operations, metal repair, sanding, and welding
Meets requirements of ANSI Z87.1-2010 and NIOSH

Typical properties

ADF Model
9100XXi, None
ADF Shade Range
None, Variable 5, 8-13
ADF Viewing Area (hwxw)
2.8x4.2in
Air Source
SAR
Battery Life
ADF: up to 1800 Hours
Battery Type
ADF: CR2032
Comes with Auto-Darkening Filter (ADF)
No, Yes
Dark Shades
Shade 5, 8

3M™ PELTOR™ Hygiene Kit HY45, 10 pair/Case

3M Product Number HY45 3M ID 7100107408 UPC 07318640067295

Details

Replacement ear cushions and foam liners

Replace at least twice a year to maintain consistent protection, hygiene, and comfort

Typical properties

Brands

PELTOR™

Case Quantity

10 pair

External Audio Input

No

Product Color

Black

Product Type

Hygiene Kit

Recommended Application

High Noise Environment

eClass 14 Classification Group

40270191

3M™ Eargage, Ear Measure 85099-00000, 50 EA/Case

3M Product Number 85099-00000 3M ID 7100141833 UPC 10078371850996

Details

Ear canal sizing tool is designed to provide a general indication of the size of the ear canal opening as a guide to initial earplug size selection

1 EA Per Case

Training tool

*The NRR may overestimate the hearing protection provided during typical use

Typical properties

Brands

3M™

Case Quantity

50

Product Color

White

Product Series

E-A-R Support Materials

Product Type

Ear Canal Sizing Tool

Recommended Application

Health & Safety Testing

3M™ SecureFit™ 400 Series Safety Glasses

Details

3M's innovative temple design features slotted ribs that provide comfortable pressure equalization, allowing the temples to flex and self-adjust to the size of the wearer's head

Curved temples apply pressure to the less sensitive back of the head, instead of the temples, achieving a comfortable fit even during rapid head movement

Motion-inspired, contoured piping in bold, modern colors

Choose from models with anti-scratch, anti-fog/anti-scratch or optional 3M™ Scotchgard™ Protector Anti-Fog Coating

U6 rated polycarbonate lenses absorb 99.9% of UVA, UVB, and UVC rays between 200 nm and 380 nm

Meets the Impact-Rated Protector requirement of the ANSI-ISEA Z87.1 Standard

Typical properties

ANSI Requirements

ANSI Z87.1-2003 and CSA Z94.3-2007

Anti Fog Lens

Yes

Brands

SecureFit™

Case Quantity

20

Class

Economy, Premium

Comfort Features

3M™ Pressure Diffusion Temple Technology, Adjustable nose bridge, Brow and nose bridge, Color-acce

Dimensions and Classifications

Overall Height (Metric)

13.97 cm

Overall Length (Imperial)

5.5 in

3M™ Custom Fit Eyewear, Black/Gray, Clear Lens, 1 Pack

3M ID 70009110332 UPC 00638060279618

Details

Give you and your crew the essential protection and undeniable style of 3M™ Performance Eyewear
Premium anti-fog coating help you see clearly for longer
Durable lenses help provide limited protection from light to moderate impact hazards
Lightweight, durable design for comfort and lasting use
Compatible with many types of additional Personal Protection Equipment (PPE)
Soft touch nose pads and earpiece enhance comfort
Anti fog, scratch resistant lenses help keep vision clear
Impact resistant lenses block 99.9% of UV rays
Meets the requirements of ANSI Z87.1 , CSA Z94.3 and AS/NZS 1337
Clear lenses help provide excellent visibility and can be used indoors or outdoors
Contains: 1 Pair of Safety Glasses

Typical properties

Brands
3M™
Catalog Number
47310H1-VDC
Factory ISO Certification
No ISO Certification information available
eClass 14 Classification Group
40230101

3M™ Eyeglass Protectors, 47030H1-DC, Clear, Clear Lens, Anti-Scratch, 6/case

3M ID 70009101091 UPC 00051141390697

Details

- Features built-in side shields
- Designed to be worn over prescription glasses
- High-impact-resistant lenses
- Anti-scratch lenses absorb up to 99.9% of UV radiation
- Meets the requirements of ANSI Z87.1-2010

Typical properties

- Brands
 - SecureFit™
- Catalog Number
 - 47030H1-DC
- Factory ISO Certification
 - No ISO Certification information available
- Frame Material
 - Polycarbonate
- Hard Coat Lens
 - No
- Material
 - Polycarbonate
- Product Type
 - Protective Eyewear
- UV Protection
 - 99.9%
- eCl

3M™ Custom Fit Eyewear, Black/Gray, Gray Lens, 1 Pack

3M ID 70009110431 UPC 00638060279632

Details

Give you and your crew the essential protection and undeniable style of 3M™ Performance Eyewear
Premium anti-fog coating help you see clearly for longer
Durable lenses help provide limited protection from light to moderate impact hazards
Lightweight, durable design for comfort and lasting use
Compatible with many types of additional Personal Protection Equipment (PPE)
Soft touch nose pads and earpiece enhance comfort
Anti fog, scratch resistant lenses help keep vision clear
Impact resistant lenses block 99.9% of UV rays
Meets the requirements of ANSI Z87.1 , CSA Z94.3 and AS/NZS 1337
Gray lenses help reduce sunlight and are popular for outdoor use
Contains: 1 Pair of Safety Glasses

Typical properties

Brands
3M™
Catalog Number
47311H1-VDC
Factory ISO Certification
No ISO Certification information available
eClass 14 Classification Group
40230101

3M™ Adflo™ Particulate, Gas, & Odor Filters

Details

Replacement part

Particle filter, gas filters, and odor filter/pad available

For use with 3M™ Adflo™ Powered Air Purifying Respirators (PAPR)

Typical properties

Cartridge or Filter Included

HE Filter, Organic Vapor/Acid gas

Case Quantity

1,2,16,6,80,20,10

Compatible Respirator

3M Adflo Powered Air Purifying Respirator

Compatible Welding Helmet

9100 Air Series, 9100 FX-Air Welding Helmets, 9100 MP Welding H

3M™ Health, Safety and Compliance Software Implementation, Pro

3M Product Number SIM-TRN-CLASSIC 3M ID 70999987251

Details

Specialized training to expedite ROI and system adoption
We'll work with you to quickly setup your account, help you define checklists, and help you to begin to tag assets and conduct inspections
Learn best practices and help ensure proper implementation
Travel included for most locations
Select full day training sessions convenient to your schedule

Typical properties

Product Type
Software
Recommended Application
Connected Safety
Recommended Industry
Construction, Food & Beverage
eClass 14 Classification Group
13030200

3M™ Safety and Inspection Manager, Pro Domain

3M Product Number SIM-DOM 3M ID 70999987269

Details

Enhance Compliance Processes - gain easier access to audit information, which means greater assurance of worker and workplace compliance

Save Time - digital inspection management reduces paperwork and time spent on documentation and compliance tasks

Be Proactive - on-demand reporting provides a direct line of sight on selected compliance metrics in real-time, helping users gain potentially valuable safety insights

Cloud-based for simple deployment and easier maintenance

Typical properties

Product Type

Software

Recommended Application

Connected Safety

Recommended Industry

Construction, Food & Beverage

Supported Mobile Devices

Refer to Technical Specification Sheet

eClass 14 Classification Group

13030200

3M™ Safety & Inspection Manager Software, Custom Package

3M Product Number SIM-ANYL 3M ID 70999987129

Details

Enhance Compliance Processes - gain easier access to audit information, which means greater assurance of worker and workplace compliance

Save Time - digital inspection management reduces paperwork and time spent on documentation and compliance tasks

Be Proactive - on-demand reporting provides a direct line of sight on selected compliance metrics in real-time, helping users gain potentially valuable safety insights

Cloud-based for simple deployment and easier maintenance

Typical properties

Product Type

Software

Recommended Application

Connected Safety

Recommended Industry

Construction, Food & Beverage

Supported Mobile Devices

Refer to Technical Specification Sheet

eClass 14 Classification Group

13030200

3M™ Safety & Inspection Manager, Classic Domain

3M Product Number SIM-DOM 3M ID 6100002210

Details

Enhance Compliance Processes - gain easier access to audit information, which means greater assurance of worker and workplace compliance

Save Time - digital inspection management reduces paperwork and time spent on documentation and compliance tasks

Be Proactive - on-demand reporting provides a direct line of sight on selected compliance metrics in real-time, helping users gain potentially valuable safety insights

Cloud-based for simple deployment and easier maintenance

Typical properties

Brands

3M™

Product Type

Software

Recommended Application

Connected Safety

Recommended Industry

Construction, Food & Beverage

Supported Mobile Devices

Refer to Technical Specification Sheet

eClass 14 Classification Group

13030200

3M™ Health, Safety and Compliance Software Implementation, Classic

3M Product Number SIM-TRN-CLASSIC 3M ID 70999987244

Details

Specialized training to expedite ROI and system adoption
We'll work with you to quickly setup your account, help you define checklists, and help you to begin to tag assets and conduct inspections
Learn best practices and help ensure proper implementation
Travel included for most locations
Select full day training sessions convenient to your schedule

Typical properties

Product Type
Software
Recommended Application
Connected Safety
Recommended Industry
Construction, Food & Beverage
eClass 14 Classification Group
13030200

3M™ Safety & Inspection Manager-Basic Unlimited Fall Protection, US, 1000

3M Product Number SIM-BASIC 3M ID 70999987236

Details

Enhance Compliance Processes - gain easier access to audit information, which means greater assurance of worker and workplace compliance

Save Time - digital inspection management reduces paperwork and time spent on documentation and compliance tasks

Be Proactive - on-demand reporting provides a direct line of sight on selected compliance metrics in real-time, helping users gain potentially valuable safety insights

Cloud-based for simple deployment and easier maintenance

Typical properties

Product Type

Software

Recommended Application

Connected Safety

Recommended Industry

Construction, Food & Beverage

Supported Mobile Devices

Refer to Technical Specification Sheet

eClass 14 Classification Group

13030200

3M™ Safety and Inspection Manager, Pro

3M Product Number SIM-PRO 3M ID 6010004158

Details

Enhance Compliance Processes - gain easier access to audit information, which means greater assurance of worker and workplace compliance

Save Time - digital inspection management reduces paperwork and time spent on documentation and compliance tasks

Be Proactive - on-demand reporting provides a direct line of sight on selected compliance metrics in real-time, helping users gain potentially valuable safety insights

Cloud-based for simple deployment and easier maintenance

Typical properties

Brands

3M™

Product Type

Software

Recommended Application

Connected Safety

Recommended Industry

Construction, Food & Beverage

Supported Mobile Devices

Refer to Technical Specification Sheet

eClass 14 Classification Group

13030200

3M™ Safety and Inspection Manager, Classic

3M Product Number SIM-CLASSIC 3M ID 6010002885

Details

Enhance Compliance Processes - gain easier access to audit information, which means greater assurance of worker and workplace compliance

Save Time - digital inspection management reduces paperwork and time spent on documentation and compliance tasks

Be Proactive - on-demand reporting provides a direct line of sight on selected compliance metrics in real-time, helping users gain potentially valuable safety insights

Cloud-based for simple deployment and easier maintenance

Typical properties

Brands

3M™

Product Type

Software

Recommended Application

Connected Safety

Recommended Industry

Construction, Food & Beverage

Supported Mobile Devices

Refer to Technical Specification Sheet

eClass 14 Classification Group

13030200

3M™ Safety and Inspection Manager Software, Analytics License

3M Product Number SIM-ANYL 3M ID 6100002302

Details

Enhance Compliance Processes - gain easier access to audit information, which means greater assurance of worker and workplace compliance

Save Time - digital inspection management reduces paperwork and time spent on documentation and compliance tasks

Be Proactive - on-demand reporting provides a direct line of sight on selected compliance metrics in real-time, helping users gain potentially valuable safety insights

Cloud-based for simple deployment and easier maintenance

Typical properties

Brands

3M™

Product Type

Software

Recommended Application

Connected Safety

Recommended Industry

Construction, Food & Beverage

Supported Mobile Devices

Refer to Technical Specification Sheet

eClass 14 Classification Group

13030200

3M™ Safety and Inspection Manager Software, Pro Additional Domain

3M Product Number SIM-DOM-PRO 3M ID 6100003507

Details

Enhance Compliance Processes - gain easier access to audit information, which means greater assurance of worker and workplace compliance

Save Time - digital inspection management reduces paperwork and time spent on documentation and compliance tasks

Be Proactive - on-demand reporting provides a direct line of sight on selected compliance metrics in real-time, helping users gain potentially valuable safety insights

Cloud-based for simple deployment and easier maintenance

Typical properties

Brands

3M™

Product Type

Software

Recommended Application

Connected Safety

Recommended Industry

Construction, Food & Beverage

Supported Mobile Devices

Refer to Technical Specification Sheet

eClass 14 Classification Group

13030200

3M™ Protecta® Confined Space Winch

Details

Incorporated mounting bracket allows for attachment to 3M Protecta tripods
4:1 Gear Ratio mechanical advantage
Durable 3/16 in. (5 mm) diameter steel cable lifeline
Lifeline lengths of 30 ft. (9 m), 50 ft. (15 m), 60 ft. (18.3 m), 75 ft. (22.9 m), and 110 ft. (33.5 m)
Recommended for use in all industries
Oil impregnated bearings
Built-in manual safety lock
Corrosion resistant construction

Typical properties

Cable Length (Imperial)
49.869 ft
Cable Length (Metric)
15.2 m
Cable Material
Galvanized Steel, Stainless Steel
Carabiner/Hook Material
Zinc Plated Steel
Case Quantity
1
Connected Safety ID Equipped
No
Dimensions
(7.50x10.90x12.00)lbs, 7.50x10

Dimensions and Classifications

Overall Length (Imperial)
30 ft, 50 ft

3M™ DBI-SALA® Positioning and Restraint Lanyard

Details

Variety of hardware options available
Variety of lifeline material options available
Equipped with 3M™ RFID

Typical properties

Anchor Connection Type
Rebar Hook, Snap Hook
Anchor Hook Material
Aluminum, Aluminum and Zinc Plated Steel, Zinc Plated Steel
Case Quantity
1
Connected Safety ID Equipped
Yes
Energy Absorber Class
None
Harness Connection Hook Material
Aluminum

Dimensions and Classifications

Overall Length (Imperial)
2 ft, 3 ft, 4 ft, 5 ft, 6 ft, 8 ft, 9 ft, 18 in, 22 in

3M™ DBI-SALA® Lad-Saf™ Vertical Safety System Stand-Off Bracket 6100710, Stainless Steel

Part Number 6100710 3M Product Number 6100710 3M ID 7012819734

Details

User installed weld-on system is fast, easy and safe
Extremely rugged and corrosion resistant stainless steel construction
Order top and bottom bracket, cable, cable guide and sleeve separately
Stand-off bracket for Lad-Saf™ steel pole top bracket

Typical properties

Attachment Type
Weld-On
Brands
DBI-SALA®
Case Quantity
1
Connected Safety ID Equipped
No
Dimensions
2 in x 0.25 in x 6 in
For Use With
Steel Pole
Install Type
Permanent
Net Weight (Imperial)
0.8 lb
Net Weight (Metric)
0.3 kg
Product Seri

3M™ DBI-SALA® Vaccum Anchor Lifeline System Fill Station 2200086

Part Number 2200086 3M Product Number 2200086 3M ID 7100227209

Details

Compact and lightweight aluminum design is easy to transport, install, and use
Provides a secure tie-off point on smooth, non-porous surfaces using vacuum technology

Approved for horizontal lifeline use

Heavy-duty storage and transport case

Fill station for compressed gas cylinder

HPA 3,000 psi high pressure nitrogen

Built-in valves for easy operation

Allows for preset output pressure

Typical properties

Brands

DBI-SALA®

Case Quantity

1

Connected Safety ID Equipped

No

For Use With

Compressed Gas Cylinder Mobi-Lok™ SCVA

Install Type

Reusable

Material

Aluminum

Net Weight (Imperial)

4.7 lb

Net Weight (Metric)

2.1 kg

Product Color

Silver

Pro

3M™ Green Polycarbonate Faceshield V2B-10P 10 EA/Case

3M Product Number V2B-10P 3M ID 7000103811 UPC 10093045936196

Details

Tinted for moderately bright environments
Lightweight
Polycarbonate faceshield is 8.25" x 12.125"
Must be attached to hard hat

Typical properties

Brands
PELTOR™
Case Quantity
10
For Use With
3M™ Peltor™ Cap-mounted Earmuffs, 3M™ Peltor™ Hard Hat Adapter P3EV/2
Product Type
Faceshield
Recommended Application
Assembly, Cleaning, Demolition, Electrical, Facility Maintenance, Grinding,
Machine

Dimensions and Classifications

Overall Height (Imperial)
8.25 in
Overall Height (Metric)
21 cm
Overall Length (Imperial)
12.125 in
Overall Length (Metric)
30.8 cm
Overall Width (Imperial)
8.25 in
Overall Width (Metric)
20.96 cm

3M™ Clear Acetate Faceshield V2A-10P 10 EA/Case

3M Product Number V2A-10P 3M ID 7000103810 UPC 10093045936189

Details

Chemical resistant
Lightweight
Protection against splash and other debris
Must be attached to hard hat

Typical properties

Brands
PELTOR™
Case Quantity
10
For Use With
3M™ Peltor™ Cap-mounted Earmuffs, 3M™ Peltor™ Hard Hat Adapter P3EV/2
Product Type
Faceshield
Recommended Application
Assembly, Cleaning, Demolition, Electrical, Facility Maintenance, Grinding,
Machine

Dimensions and Classifications

Overall Height (Imperial)
8.25 in
Overall Height (Metric)
21 cm
Overall Length (Imperial)
12.125 in
Overall Length (Metric)
30.8 cm
Overall Width (Imperial)
8.25 in
Overall Width (Metric)
20.96 cm

3M™ Elevated Temperature Cotton + Para-aramide Front Helmet Cover, FC1-GR, Gray, 60 EA/Case

3M Product Number FC1-GR 3M ID 7100082485 UPC 04054596088269

Details

Designed for 3M hard hats with face shield holder
Designed to provide additional protection to the wearer and the safety helmet
Provides protection against sparks and metal spatter
Streamlined design helps prevent interference with other equipment during use
Reduces the possibility of particulate dropping into the users face when the
faceshield is lifted

Typical properties

Brands
3M™
Compatible Hard Hat
H-700T, H24M, H24T
For Use With
Hard Hats
High Heat
Yes
Material
Cotton + Para-aramid
Product Color
Gray
Product Type
Front Helmet Cover
eClass 14 Classification Group
46080105

3M™ Versaflo™ High Durability Hood with Integrated Head Suspension S-533S, Small/Medium, 1 EA/Case

3M Product Number S-533S 3M ID 7000127432 UPC 00051131170896

Details

Size: Small/Medium

Available in two different sizes to suit customer needs

Ready to use straight out of the box

Suitable for applications which require frequent replacement of the entire headtop assembly or those where there is less soiling of the outer fabric

Typical properties

Assigned Protection Factor

1000

Brands

Versaflo™

CFM Capacity per Minute

100 CFM, 50 CFM

Compatible With

3M™ Powered Air Purifying and Supplied Air Respirator Systems

Headgear Type

Hood with Suspension

High Heat

No

Material

Polyurethane Coate

3M™ PELTOR™ X3 Earmuffs X3B, Behind-the-Head, 10 EA/Case

3M Product Number X3B 3M ID 7100123158 UPC 10078371671256

Details

Design of neckband allows earmuffs to be worn with a variety of face shields and headgear

Compatible with headgear without accessory slots

Soft, adjustable head strap helps to maintain a secure fit with many different types of headgear

Fit can be confirmed: Verify with 3M™ E-A-Rfit™ Dual-Ear Validation System***

X3 products have medium attenuation: Perfect for the mid-level noise environments

Typical properties

Attenuation Rating

28.0 Decibel

Attenuation Rating (SNR)

28 Decibel

Bluetooth

No

Brands

PELTOR™

Case Quantity

10

Corded

No

Dielectric

No

Earmuff Style

Behind the Head

Electrically Insulated

No

Hearing Protection Style

Behind the Head, B

3M™ Particulate Respirators 8000 Cup Series

Details

Designed to meet NIOSH certification standards
Some models available with 3M™ Cool Flow™ Exhalation Valve to help release warm and moist exhaled breath from inside the respirator
Adjustable noseclip options help provide a custom seal
Some models available with fully adjustable buckle straps or dual elastic headbands for maximum comfort and effectiveness
3M proprietary filter media designed for ease of breathing

Typical properties

Acid Gas Reduction
No
Advanced Electrostatic Media
Yes
Braided Comfort Strap
No, Yes, Yes (Wide)
Brands
3M™
Cake-Resistant Filter Media
No
Class
Comfort, Comfort Plus, Specialty
Cool Flow™ Exhalation Valve
No, Yes
Enhanced Comfort
No, Yes

3M™ DBI-SALA® Center Mount Sleeve Davit Base

Details

Center mount sleeve davit base
360 degree davit mast rotation
PVC davit mast sleeve liner
Permanent installation with standard tools
Also available in stainless steel

Typical properties

Case Quantity
1
Connected Safety ID Equipped
No
Dimensions
31.80x20.30x24.10cm
Install Type
Portable
Material
Galvanized Steel, Stainless Steel
Net Weight (Imperial)
25.3 lb
Net Weight (Metric)
11.5 kg
Product Series
Advanced™
Product Type

3M™ Nut Base W-2920, 1 EA/Case

3M Product Number W-2920 3M ID 7100063933 UPC 00051138155254

Details

Used with the 3M™ Compressed Air Filter and Regulator Panel W-2806

Typical properties

Brands

3M™

CFM Capacity per Minute

100 CFM, 50 CFM

Case Quantity

1/pack

Compatible With

3M™ W-2806 Filtration Panel

Pressure Type

High

Product Color

Metal

Product Series

Supplied Air

Product Type

Nut Base

Supplied Air Respirator Style

W-S

3M™ Carbon Monoxide Sensor 529-05-22, 1 EA/Case

Part Number 72018 3M Product Number -500604 3M ID 7000131709

Details

For use with certain 3M™ air filtration and regulator panels
Replacement part

Typical properties

Brands

3M™

CFM Capacity per Minute

100 CFM, 50 CFM

Case Quantity

1/case

Compatible With

3M™ Retrofit CO Monitor Kit W-2808

Product Color

White

Product Series

Supplied Air

Product Type

Carbon Monoxide Monitor

Supplied Air Respirator Style

MS

3M™ Versaflo™ Respiratory Systems Carry Bag, 1/case

3M Product Number TR-991 3M ID 7100061107

Details

Ideal for convenient storing and transporting your complete 3M™ Versaflo™ Powered & Supplied Air System

Typical properties

Brands

Versaflo™

Case Quantity

1/case

Compatible With

3M™ Versaflo™ TR-600 Series PAPR

Product Series

TR-Series

Product Type

Carrying Bag

Recommended Industry

Design & Construction, Facility Sanitation, Food Safety, Heavy Infrastructure, Indust

3M™ Breathe Easy™ PAPR Cartridges

Details

For use with 3M™ Breathe Easy™ Powered Air Purifying Respirator (PAPR) Systems
NIOSH-approved

Typical properties

Case Quantity

12,6

Compatible Respirator

Breathe Easy

Compatible with 3M™ PAPR Systems

Yes

Gas & Vapor Protection Type

Chlorine, Hydrogen Chloride, Hydrogen Fluoride, Organic Vapor, Sulfur Dioxide

NIOSH Cartridge or Filter Assigned Color Coding

M

3M™ DBI-SALA® SSB Cable Climb Assist System Mounting Bracket 3511783, Fits Round Rung to 3/4 in, Square Rung to 9/16 in

Part Number 3511783 3M Product Number 3511783 3M ID 7100268946

Details

No limit to length of system
Aluminum housing
Aids workers and provides fall protection while climbing lengthy ladders and towers

Typical properties

Attachment Type
Bolt and Clamp-On
Brands
DBI-SALA®
Case Quantity
1,1 EA/Case
Connected Safety ID Equipped
No
Dimensions
2 in x 2 in x 74.5 in
For Use With
Lad-Saf Flexible Ladder System
Install Type
Permanent
Lifeline Material
Galvanized St

3M™ DBI-SALA® SSB Cable Climb Assist System Mounting Bracket 3511785, Fits Round Rung 3/4 - 1-1/2 in, Square Rung 9/16 - 1-1/2 in

Part Number 3511785 3M Product Number 3511785 3M ID 7100268006

Details

No limit to length of system

Aluminum housing

Aids workers and provides fall protection while climbing lengthy ladders and towers

Typical properties

Attachment Type

Bolt and Clamp-On

Brands

DBI-SALA®

Case Quantity

1

Connected Safety ID Equipped

No

Dimensions

2 in x 2 in x 74.5 in

For Use With

3M™ DBI-SALA® SSB Climb Assist Block/Pulley Assembly 3511063

Install Type

Permanent

Lifeline Mat

3M™ Scott™ Ska-Pak Supplied-Air Respirator

3M ID B5005047150

Details

Combination Type C positive pressure respirator with escape cylinder for entry into or escape from hazardous, confined space, or immediately dangerous to life or health (IDLH) situations

Fire resistant Kevlar or polypropylene harness

The E-Z Flo regulator is designed for gloved hands, enables easy breathing, and has a two-step secure attachment to help ensure worker confidence

Available in 2216 and 4500 psi and 5 or 15 minute rated-cylinder egress options for versatility based on job at hand

The cylinder is hip-mounted with a durable, secure cylinder band retention system

NIOSH approved for use with 3M Scott AV series facepieces that can also be used for APR, PAPR, supplied air, and SCBA applications

Kevlar - ideal in high heat environments or when there is potential for sparking

Typical properties

Brands

Scott™

Compatible Facepiece

AV-3000 SureSeal

Connection Type

Compressed Air Line

In-line Air Filter Included

No

Product Type

Supplied Air Respirator

Specifications Met

NIOSH 42 CFR

3M™ Scott™ Air-Pak™ X3 SCBA

3M ID B5005047166

Details

- NIOSH approved
- Available with CGA or Snap-Change cylinder connection
- Available in 2.2, 4.5, or 5.5 cylinder pressures
- Dual-redundant pressure reducer
- Improved weight distribution
- Contoured backframe design
- Articulating shoulder harness
- Improved hose and wire management
- Optimally positioned buddy lights
- PASS pre-alarm indication on HUD
- External HUD for easy air status updates
- Vibralert tactile End-of-Service-Time Indicator (EOSTI)
- Reduced cost of ownership
- Proudly “Made in the USA” with attention to quality and workmanship

Typical properties

- Brands
- Scott™
- Product Type
- Self-contained Breathing Apparatus

3M™ Scotchlite™ Reflective Material 8906 Series

Details

Wash Durability: Wash longevity and brightness over the life of the material
Off-Angle Brightness: 32-angle table brightness compliance to help keep wearers visible from many angles
Independently certified to OEKO-TEX® Standard 100
Use Performance: Performance to industry standard testing for abrasion, flexing, cold-folding and rainfall
Product Authentication: 3M™ Scotchlite™ Reflective Material logo printed on backside of fabric

Typical properties

Adhesive
None
Attachment Type
Sew On
Backing Material
Polyester/Cotton
Brands
Scotchlite™
Configurable
No, Yes
Daytime Color
Silver
Flame Resistant
No
Home Wash Cycles 60°C (140°F) at ANSI Certified Standards
30
Home Wash Cycles 60°C (140°

Dimensions and Classifications

Overall Length (Imperial)
218.72 yd, 218.723 yd
Overall Length (Metric)
200 m
Overall Width (Imperial)
1 in, 1.5 in, 2 in
Overall Width (Metric)
25.4 mm, 38.1 mm, 50.8 mm

3M™ Speedglas™ G5-01 Welding Helmet Powered Air System

Details

Provides High-Efficiency particulate respiratory protection
Robust, compact design
Ergonomic, adjustable head suspension
Flip front welding shield allows for a clear, wide-view protective visor for grinding and setup
Available in two different Auto-Darkening Lens options (VC/TW)
Audible and visual alarms signal low airflow and low battery charge
G5 Series storage/carry bag included

Typical properties

ADF Model
G5-01, G5-01VC, None
Air Source
PAPR
Battery Life
Turbo: approx. 7 - 9 Hours
Battery Type
Turbo: Lithium-ion
Brands
Speedglas™
Cartridge or Filter Included
HE Filter
Case Quantity
1 EA/Case
Comes with Auto-Darkening Filter (ADF)
N

3M™ Full Facepiece Respirator Packout 07162, Organic Vapor/P95, Medium

Part Number 07162 3M ID 7010315862 UPC 00051131071629

Details

Packout includes 1 Full Facepiece Respirator 07139 (medium), 1 pair organic vapor cartridges 07046, 1 pair filter retainers 07054, 2 pairs of P95 filters 07194 and 2 faceshield covers 07142

Spray paint applications

Replacement cartridges and filters are also available in a 3M packout 07195

For occupational use only

Typical properties

Brands

3M™

Connection Type

Bayonet

Mask Size

Medium

Suspension Type

4 Point Strap

eClass 14 Classification Group

40220113

3M™ Full Facepiece Respirator Packout 07163, Organic Vapor/P95, Large

Part Number 07163 3M ID 7000126282 UPC 00051131071636

Details

Packout includes 1 Full Facepiece Respirator 07140 (large), 1 pair organic vapor cartridges 07046, 1 pair filter retainers 07054, 2 pairs of P95 filters 07194 and 2 faceshield covers 07142

Spray paint applications

Replacement cartridges and filters are also available in a 3M packout 07195

For occupational use only

Typical properties

Brands

3M™

Connection Type

Bayonet

Mask Size

Large

Recommended Industry

Marine

Suspension Type

4 Point Strap

eClass 14 Classification Group

40220113

3M™ Lens Frame Kit 7885, Replacement Part 5 EA/Case

3M Product Number 7885 3M ID 7000125978 UPC 50021200603346

Details

Approved 3M replacement part
Recommended for 3M Full Facepiece 7000 Series (sold separately)
Use to attach 3M™ Lens 7884 to facepiece (sold separately)
Replacement lens frame kit can extend service life of facepiece
Replaceable part can potentially result in respiratory equipment cost savings

Typical properties

Accessories
No
Boxes per Case
5
Brands
3M™
Cartridge or Filter Included
No
Case Quantity
5/case
Clip-on Welding Shield
No
Compatible with 3M™ PAPR Systems
No
Compatible with 3M™ Supplied Air System
No
Compatible with Welding Shield
No
Co

3M™ Secure Click™ Lens Frame Assembly FF-800-02, 5 ea/Case

3M Product Number FF-800-02 3M ID 7100266242 UPC 00638060432143

Details

Lens frame assembly replacement includes the frame with a pair of screws and nuts

Replaceable part can potentially result in respiratory equipment cost savings

Typical properties

Accessories

Yes

Brands

Secure Click™

Case Quantity

5

Compatible Respirator

FF-800 Series, Secure Click™ HF-800 Series Full Facepiece Reusable Respirators

Compatible with 3M™ PAPR Systems

No

Compatible with 3M™ Supplied Air System

No

Enhanced C

Dimensions and Classifications

Overall Height (Imperial)

1.422 in

Overall Height (Metric)

36.127 mm

Overall Length (Imperial)

7.784 in

Overall Length (Metric)

197.723 mm

Overall Width (Imperial)

5.845 in

Overall Width (Metric)

148.46 mm

3M™ Lens Frame Assembly FF-400-05, 5 EA/Case

3M Product Number FF-400-05 3M ID 7000052736 UPC 50051135894779

Details

Replacement part to use with 3M Ultimate FX Full Facepiece Reusable Respirators FF-401, FF-402, and FF-403 (sold separately)
Lens frame assembly replacement includes a screw, nut, and identification plate
Maintains original performance standards of facepiece
Lightweight frame weighs only 1.8 ounces
Replaceable part can potentially result in respiratory equipment cost savings

Typical properties

Accessories
Yes
Boxes per Case
5
Brands
3M™
Case Quantity
5/case
Clip-on Welding Shield
No
Compatible with 3M™ PAPR Systems
No
Compatible with 3M™ Supplied Air System
Yes
Compatible with Welding Shield
No
Cool Flow™ Exhalation Valve
Yes

3M™ Breathing Room Assembly 7916-5, Replacement Part 5 EA/Case

3M Product Number 7916-5 3M ID 7000126023 UPC 50051138215632

Details

Approved 3M replacement part
Designed for 3M Full Facepieces 7800 Series (sold separately)
Replacement part can extend service life of facepiece
Use can potentially result in respiratory equipment cost savings
Assembly maintains original service performance of facepiece

Typical properties

Accessories
No
Boxes per Case
5
Brands
3M™
Case Quantity
5/case
Clip-on Welding Shield
No
Compatible with 3M™ PAPR Systems
No
Compatible with 3M™ Supplied Air System
No
Compatible with Welding Shield
No
Cool Flow™ Exhalation Valve
No
Dro

3M™ Secure Click™ Inhale & Exhale Valve, HF-800-02, 10 EA/Bag

3M Product Number HF-800-02 3M ID 7100181933 UPC 04054596621992

Details

Replacement part for 3M™ Secure Click™ Half Facepiece Reusable Respirator HF-800 Series

Used as both the inhalation and exhalation valves

Each HF-800 Series facepiece contains two HF-800-02 replacement valves

Exhalation valve directs exhaled breath and moisture downward

Inhalation valve allows filtered air to pass into the respirator

Replacement valves can extend the service life of HF-800 Series facepieces and potentially result in cost savings

For workplace/occupational use only

Package contents: 1 case contains 10 each replacement valves

Typical properties

Accessories

Yes

Brands

Secure Click™

Case Quantity

10

Clip-on Welding Shield

No

Compatible Respirator

Secure Click™ HF-800 Series Half Facepiece Reusable Respirators

Compatible with 3M™ PAPR Systems

No

Compatible with 3M™ Supplied Air System

Dimensions and Classifications

Overall Height (Metric)

40 mm

Overall Length (Metric)

7.9 mm

Overall Width (Metric)

29 mm

3M™ Speedglas™ Welding Starter Kit 9100X 06-0201-20, 1 EA/Case

3M Product Number 06-0201-20 3M ID 7010384805 UPC 00051141561998

Details

Welding kit includes 5 outside protection plates, 2 inside protection plates, and 1 sweat pad

Integrates with 3M™ 9100 Series ADF

Applications include metal repair, assembly, and mechanical

For use in the construction, heavy infrastructure, and industrial maintenance industries

Full ADF assembly meets the requirements of ANSI Z87.1-2010

Typical properties

ADF Viewing Area (Metric)

54 mm x 107 mm

ADF Viewing Area (hwx)

2.1x4.2in

Brands

Speedglas™

Case Quantity

1

Compatible Welding Helmet

9100 Series

Features

9100 Series Accessory

For Use With

3M™ Speedglas™ 9100X Auto-darkening Filter

Material

3M™ Speedglas™ Welding Starter Kit 9100XX 06-0201-30, 1 EA/Case

3M Product Number 06-0201-30 3M ID 7010315299 UPC 00051141562001

Details

Welding kit includes 5 outside protection plates, 2 inside protection plates, and 1 sweat pad

Integrates with 3M™ 9100 Series ADF

Applications include metal repair, assembly, and mechanical

For use in the construction, heavy infrastructure, and industrial maintenance industries

Full ADF assembly meets the requirements of ANSI Z87.1-2010

Typical properties

ADF Viewing Area (Metric)

73 mm x 107 mm

ADF Viewing Area (hwx)

2.8x4.2in

Brands

Speedglas™

Case Quantity

1

Compatible Welding Helmet

9100 Series

Features

9100 Series Accessory

For Use With

3M™ Speedglas™ 9100Xi Auto-Darkening Filter

Product

3M™ Speedglas™ Welding Starter Kit 9100V 06-0202-10, for 9100MP, 1 EA/Case

3M Product Number 06-0202-10 3M ID 7010384806 UPC 00051141562018

Details

Welding kit includes 5 outside protection plates, 2 inside protection plates, and 1 sweat pad

Integrates with 3M™ 9100 Series ADF

Applications include metal repair, assembly, and mechanical

For use in the construction, heavy infrastructure, and industrial maintenance industries

Full ADF assembly meets the requirements of ANSI Z87.1-2010

Typical properties

Brands

Speedglas™

Case Quantity

1

Compatible Welding Helmet

9100 Series

Features

9100 Series Accessory

Product Series

9100, 9100 FX, 9100 MP, 9100 QR, 9100-Air, L-Series

Product Type

Starter Kit

Recommended Application

Assembly, Facility Main

3M™ Speedglas™ Welding Starter Kit 9100X 06-0202-20, for 9100MP, 1 EA/Case

3M Product Number 06-0202-20 3M ID 7010341131 UPC 00051141562025

Details

Welding kit includes 5 outside protection plates, 2 inside protection plates, and 1 sweat pad

Integrates with 3M™ 9100 Series ADF

Applications include metal repair, assembly, and mechanical

For use in the construction, heavy infrastructure, and industrial maintenance industries

Full ADF assembly meets the requirements of ANSI Z87.1-2010

Typical properties

ADF Viewing Area (Metric)

54 mm x 107 mm

ADF Viewing Area (hwx)

2.1x4.2in

Brands

Speedglas™

Case Quantity

1

Compatible Welding Helmet

9100 Series

Features

9100 Series Accessory

Product Series

9100, 9100 FX, 9100 MP, 9100 QR, 9100-Air, L-Serie

3M™ Speedglas™ Welding Starter Kit 9100XX 06-0202-30, for 9100MP, 1 EA/Case

3M Product Number 06-0202-30 3M ID 7010384807 UPC 00051141562032

Details

Welding kit includes 5 outside protection plates, 2 inside protection plates, and 1 sweat pad

Integrates with 3M™ 9100 Series ADF

Applications include metal repair, assembly, and mechanical

For use in the construction, heavy infrastructure, and industrial maintenance industries

Full ADF assembly meets the requirements of ANSI Z87.1-2010

Typical properties

Brands

Speedglas™

Case Quantity

1

Compatible Welding Helmet

9100 Series

Features

9100 Series Accessory

For Use With

3M™ Speedglas™ 9100MP Welding Helmets, 3M™ Speedglas™ 9100XX Welding Helmets

Product Series

9100, 9100 FX, 9100 MP, 9100 QR, 910

3M™ Welding Protective Covers, Hoods, & Shrouds

Details

Extended protection for the crown of the head, throat/neck, and/or ears during heavy welding or grinding applications

Helps protect extended areas of the head and neck against UV light, sparks and spatter

Accessories attach easily to 3M™ Speedglas™ Welding Helmets

For assembly, facility maintenance, grinding, machine operations, sanding, and welding applications

For highest possible safety and comfort, regularly check your equipment for worn or damaged parts

Typical properties

Case Quantity

1

Clip-on Welding Shield

No

Compatible Welding Helmet

9000 Series, 9100 FX Welding Helmets, 9100 FX-Air Welding Helmets, 9100 MP Welding Helmets, 9100 Series, G5-01 Welding Helmets, G5-02 Welding Helmets

Compatible with 3M™ PAPR System

3M™ PELTOR™ ProTac III MT13H220A, Slim Headset, Black, Headband, 10 Each/Case

3M Product Number MT13H220A 3M ID 7100088456 UPC 04054596123106

Details

Professional-Quality Hearing Protection (21dB NRR)

Environmental microphones for level-dependent hearing protection and ambient listening

3.5 mm listen-only stereo input (limited to 82 dB) for connection to external devices (e.g. cell phone, two-way radio, Ipod)

Voice guided menu system to prevent you from taking the headset off

Auto power off, the headset will turn off after 4 hrs of non-use to save battery

Low-battery warning to inform you when to change batteries

To reduce corrosion caused by sweat and moisture, the electronics are located in a separate compartment of the cup

Available in both in headband and hard hat attached versions (black)

Occupational use only

Typical properties

Attenuation Rating

21 dB

Audio Type

Communication

Auxiliary Port

3.5mm

Battery Life

100 Hours

Bluetooth

No

Brands

PELTOR™

Built In FM and or AM Radio

No

Built in 2-Way Radio

No

Case Quantity

10

Communication Direction

Listen-only

Commu

3M™ PELTOR™ ProTac III MT13H220P3E, Slim Headset, Black, Helmet Attached, 10 Each/Case

3M Product Number MT13H220P3E 3M ID 7100088455 UPC 04054596123199

Details

Professional-Quality Hearing Protection (19dB NRR)

Environmental microphones for level-dependent hearing protection and ambient listening

3.5 mm listen-only stereo input for connection to external devices (e.g. cell phone, two-way radio, Ipod)

Voice guided menu system for ease of use and adjusting settings

Auto power off, the headset will turn off after 4 hrs of non-use to save battery

Low-battery warning to inform you when to change batteries

To reduce corrosion caused by sweat and moisture, the electronics are located in a separate compartment of the cup

Available in both in headband and hard hat attached versions (black)

Occupational use only

Typical properties

Attenuation Rating

21 dB, 19 dB

Audio Type

Communication

Auxiliary Port

3.5mm

Battery Life

100 Hours

Bluetooth

No

Brands

PELTOR™

Built In FM and or AM Radio

No

Built in 2-Way Radio

No

Case Quantity

10

Communication Direction

Listen-only

3M™ PELTOR™ ProTac III MT13H221P3E, Headset, Black, Helmet Attached, 10 Each/Case

3M Product Number MT13H221P3E 3M ID 7100088423 UPC 04054596123250

Details

Professional-Quality Hearing Protection (23dB NRR)

Environmental microphones for level-dependent hearing protection and ambient listening

3.5 mm listen-only stereo input for connection to external devices (e.g. cell phone, two-way radio, Ipod)

Voice guided menu system for ease of use and adjusting settings

Auto power off, the headset will turn off after 4 hrs of non-use to save battery

Low-battery warning to inform you when to change batteries

To reduce corrosion caused by sweat and moisture, the electronics are located in a separate compartment of the cup

Available in both in headband and hard hat attached versions (black)

Occupational use only

Typical properties

Attenuation Rating

23 dB

Audio Type

Communication

Auxiliary Port

3.5mm

Battery Life

100 Hours

Bluetooth

No

Brands

PELTOR™

Built In FM and or AM Radio

No

Built in 2-Way Radio

No

Case Quantity

10

Communication Direction

Listen-only

Commu

3M™ Speedglas™ Welding Helmet Battery 04-0320-00/37137(AAD), 1 EA/Case

3M ID 7000126763 UPC 50051131371373

Details

Original 3M™ Accessory

Rechargeable

Standard or heavy duty

Standard or high capacity

For highest possible safety and comfort, regularly check your equipment for worn or damaged parts

Typical properties

Battery Life

2500 hours

Battery Type

CR2032

Brands

Speedglas™

Case Quantity

1

Compatible Welding Helmet

9000 Series

Features

ADF Accessory

Product Series

100, 9000, 9000 FlexView, 9000 Utility, 9100, 9100 FX, 9100 MP, 9100-Air, SL

Product Ty

3M™ DBI-SALA® Remote Anchoring System

Details

Installs an anchor and lifeline to the top of a steel structure from the ground
Snap hook attachment/removal tool allows you to easily attach and detach a snap hook and lanyard to the tie-off adaptor
Tie-off adaptor attachment/removal tool allows you to easily install your adaptor to a steel structure and remove it
Compact, lightweight design is portable and reusable
Compatible with various fall arrest systems
Carrying bag for easy transport and storage
Tie-off adaptor installation/removal tool
Installs anchor and lifeline to top of steel structure from the ground
Allows user to easily work around obstructions
Lifeline or lanyard sold separately

Typical properties

Anchor Install Type
Reusable
Attachment Type
Pass-through/Choker
Case Quantity
1
Connected Safety ID Equipped
Yes
Descent Type
None, Vertical
Install Type
Reusable
Material
Polyester Web
Maximum Number of Users
N/A, One
Pole Adjustment Ran

3M™ PELTOR™ FLX2 Cables

Details

Coiled polyurethane cable
FLX2 plug for connection to a wide assortment PELTOR headsets
Kevlar® reinforced
Robust and highly flexible

Typical properties

Case Quantity
120/Case, 1,200/Case, 60, 120
Communication Type
FLX2 Headset with PTT
Compatible Radio Brands
3.5mm auxiliary port, Hytera, Icom, Kenwood, Motorola, PELTOR, Sepura
Intrinsically Safe
No, Yes
Package Quantity
1
Plug Type
1/4 in Ster

3M™ PELTOR™ Hygiene Tape for Microphone, HYM1000, 4.5 M, 96 ea/Case

3M ID 7100064281

Details

Moisture and wind-resistant hygienic tape that protects the speech microphone
Pack of 16 feet (5 meters) is enough for about 50 replacements
Quick and easy to fit
3M™ PELTOR™ spare part

Typical properties

Bluetooth
No
Brands
PELTOR™
Built In FM and or AM Radio
No
Built in 2-Way Radio
No
Case Quantity
96
Communication via External 2-Way Radio
No
Hearing Protection Style
Earmuff
Hearing Protection Type
Spare Part
Intrinsically Safe
No
Level

3M™ PELTOR™ Cell Phone Patch Cord FL6CS 1 EA/Case

3M Product Number FL6CS 3M ID 7000107804 UPC 07318640042759

Details

Patch cable for use with the 3M™ PELTOR™ LiteCom Plus and LiteCom Pro II Headsets
2.5mm plug
CAUTION: Not certified for Intrinsic Safety
Listen-only cable

Typical properties

Auxiliary Port
4-pin XLR
Brands
PELTOR™
Compatible Radio Brands
2.5mm auxiliary port
Intrinsically Safe
No
Plug Type
2.5mm stereo
Product Color
Black
Product Type
Cable
Purpose
Exclude
Recommended Application
Assembly, Demolition, Electri

3M™ PELTOR™ Right Side Boom Mounting Y-Harness FL6AB, 1 EA/Case

3M Product Number FL6AB 3M ID 7000107801 UPC 07318640027589

Details

For left cup microphone placement on ComTac/SwatTac series
For ComTac II use FL6AC harness assembly
Standard PELTOR wiring set-up

Typical properties

Brands
PELTOR™
Intrinsically Safe
No
Product Color
Green
Product Type
Cable
Purpose
Exclude
eClass 14 Classification Group
40270191

3M™ PELTOR™ Skull Screw Communication Tip Replacements, 10 EA/Case

3M Product Number 370-1019-10 3M ID 7000128201 UPC 10093045936455

Details

3M™ PELTOR™ Skull Screw™ Replacement Eartips

10 EA/Case

Push-to-fit style means no earplug roll-down is required for easy fitting

Helps provide protection while enabling the user to hear in noisy environments

Typical properties

Brands

PELTOR™

Hearing Protection Type

In-Ear

Product Color

Gray

Product Type

Eartip

Purpose

Exclude

Recommended Industry

Hunting, Law Enforcement, Military Maintenance, Repair & Operation (MRO),

Military Tactical, Shooting

Specifications Met

3M™ PELTOR™ Gel Ear Cushions for Peltor Headsets HY80A, U.S. Made, 1 EA/Case

3M Product Number HY80A 3M ID 7100014310 UPC 00093045934676

Details

Gel ear cushions for use on a wide variety of 3M™ PELTOR™ Headsets
Super-soft foam for enhanced comfort
High-temp adhesive suited for hotter and more demanding environments
1 pair

Typical properties

Brands
PELTOR™
Product Type
Ear Cushion
eClass 14 Classification Group
40270191

3M™ PELTOR™ Camelback Gel Sealing Rings HY80, 1 pr/cs

3M Product Number HY80 3M ID 7000127268 UPC 00093045979493

Details

Gel ear cushions for use on a wide variety of 3M™ PELTOR™ Headsets

Super-soft foam for enhanced comfort

1 pair

Gel -filled replacement cushions maintain a comfortable, noise-blocking seal around ears

Sealing rings maintain original service performance of Peltor products

Typical properties

Brands

PELTOR™

Case Quantity

1

Product Color

Black

Product Type

Hygiene Kit

Purpose

Exclude

eClass 14 Classification Group

40270191

3M™ Protective Coverall 4570

Details

Constructed from multi-layer, non-microporous PE laminate material for Type 3, 4, 5, and 6 protection
Innovative seam technology featuring stitched seams reinforced with five-layer chemically protective tape offers increased protection
High-performance fabric with a soft, anti-static inner layer helps reduce distraction and noise caused by movement
Features elastic hood, waist, cuffs, and ankles so that the coveralls stay in place
Recommended for chemical mixing and handling, oil spills and cleanup, hazardous waste remediation, metal etching and refining, and more
12 units included in each case

Typical properties

Additional Protection Features

Antistatic Protection, Biological Protection, Radioactive Particulate Protection

Closure Method

Simple Zipper

Coverall Style

Hooded

Features

3 Panel Hood, Chin Flap, Double Closing Stormflap System, Elastic Cuff, Elas

3M™ DBI-SALA® Rescue Pole 8900299, Black, 1 EA

Part Number 8900299 3M Product Number 8900299 3M ID 7100214233

Details

Rescue pole designed for assisted rescue of worker after fall
Compact, lightweight aluminum construction built for fast and efficient rescue
No special tools or training required
Capture head and aluminum carabiner with 0.813 in. gate opening
Pole adjusts from 2.16 ft. to 8.66 ft. (.66 m - 2.64 m)
12 ft. (3.6 m) tagline
Recommended for use in construction, mining, oil and gas, transportation, utilities, and general industrial applications
Ideal for use with a self-rescue detachable descent device
Carrying bag included

Typical properties

Brands
DBI-SALA®
Case Quantity
1
CoWorker Controlled Ascent
Yes
CoWorker Controlled Descent
Yes
Connected Safety ID Equipped
No
Descent Type
Vertical
Maximum Number of Users
One
Maximum Pole Length (Imperial)
10 ft
Maximum Pole Length (Met

Dimensions and Classifications

Overall Length (Imperial)
2.16 ft

3M™ Solus™ 1000 Series Safety Glasses

Details

3M™ Scotchgard™ Protector Anti-Fog Coating resists fogging longer than traditional anti-fog coatings through up to 25 washings with water* and helps provide scratch resistance in tough work environments. *Based on 3M internal testing per EN168 test method when compared with traditional anti-fog coatings

Configurable design with detachable gasket, strap or temple options

Contemporary styling with padded temples and soft nosebridge for added comfort

U6 rated polycarbonate lenses absorb 99.9% of UVA, UVB, and UVC rays between 200 nm and 380 nm

Meets both the Impact-Rated Protector and Anti-Fog Performance (X) requirements of the ANSI-ISEA Z87.1-2020 Standard

Typical properties

3M Technology
Scotchgard Anti-Fog Coating
ANSI Requirements
ANSI Z87.1-2003 and CSA Z94.3-2007
Anti Fog Lens
Yes
Brands
Solus™
Case Quantity
20
Class
Premium
Comfort Features
Color-accented temples, Contains Foam Gasket, Dual-injected, Elasti

Dimensions and Classifications

Overall Height (Imperial)
2 in, 10 in
Overall Height (Metric)
5.08 cm, 25.4 cm
Overall Length (Imperial)
2 in, 10 in
Overall Length (Metric)
5.08 cm, 25.4 cm
Overall Width (Imperial)
2 in, 5 in
Overall Width (Metric)
5.08 cm, 12.7 cm

3M™ OX™ Safety Glasses

Details

Over-the-glass coverage for prescription eyeglass wearers
Adjustable temples
Built-in sideshields
Polycarbonate lens absorbs 99.9% of harmful UVA and UVB rays
Meets the Impact-Rated Protector requirement of the ANSI-ISEA Z87.1-2020 Standard

Typical properties

ANSI Requirements
ANSI Z87.1-2003
Anti Fog Lens
Yes
Brands
3M™
Case Quantity
20
Class
Economy
Comfort Features
Adjustable temples fits over most personal prescription eyewear, Cord Control System Temples w/Earplug Attachment, and Rubber Temple

Dimensions and Classifications

Overall Height (Imperial)
6.5 in
Overall Height (Metric)
16.51 cm
Overall Length (Imperial)
6.5 in
Overall Length (Metric)
16.51 cm
Overall Width (Imperial)
1.5 in
Overall Width (Metric)
3.81 cm

3M™ DBI-SALA® Confined Space Integrated Barrel Mount Sleeve Davit Mast Base 8510323, Zinc Plated Steel

3M Product Number 8510323 3M ID 7100260032 UPC 00840779005994

Details

Barrel mount sleeve davit base, adjustable up to 4.5 in. tank flange wall thickness
Designed for use with davit mast
Davit mast rotation limited to specific work area (see product instructions for more info)
Recommended for use in multiple industries
Suitable with davit mast for fall protection in shoring applications
Set-up and dismantle without tools
Heavy-duty corrosion resistant plated steel construction

Typical properties

Brands

Advanced™

Case Quantity

1

Connected Safety ID Equipped

No

Dimensions

26.70x25.90x31.80cm

Install Type

Portable

Product Series

Advanced™

Recommended Industry

Construction, General Industrial, Mining, Oil & Gas, Transportation, Utilities

3M™ DBI-SALA® Carabiner

Details

User friendly compact design
Variable width gate opening steel or aluminum carabiner
Versatility of attachment to fall protection systems
Corrosion-resistant
Available in multiple sizes and shapes
Recommended for mining, oil and gas, utilities, wind energy, and general industrial applications
Meets the requirements of EN362 and ANSI/ASSP 359.12-2019
High-strength steel or aluminum construction
Durable and lightweight
Dual and triple-action models, self-closing and locking gate for added safety

Typical properties

Attachment Type
Hook
Carabiner/Hook Material
Zinc Plated Steel
Case Quantity
1
Connected Safety ID Equipped
No
Dimensions
4.33x2.66x0.75in, 7.00x4.00x0.75in, 110 x 68 x 19 mm, 7.00x4.70x0.75in
Gate Opening (Imperial)
0.6875 in, 1.1875 in, 2 in
Ga

3M™ DBI-SALA® Ultra-Lok™ Self-Retracting Lifeline

Details

- Durable aluminum or thermoplastic housing
- Available in multiple configurations, lifeline lengths, and material types
- Reliable fall arrest energy dissipation system
- Quick activating speed-sensing locking system
- Constant contact pawl system
- Swiveling anchorage connector loop
- Swiveling self-locking snap hook with impact indicator
- 3M™ Connected Safety ID (CSID) embedded in polyurethane bumper
- Emergency retrieval system available on some models

Typical properties

- Anchor Connection Type
 - Carabiner
- Anchor Hook Material
 - Stainless Steel, Zinc Plated Steel
- Anchor Hook Material
 - Stainless Steel, Zinc Plated Steel
- Average Arrest Force (Imperial)
 - 1350 lbf (OSHA 130 lb - 310 lb), 900 lbf (OSHA 130 lb - 310 lb)
- Averag

Dimensions and Classifications

- Overall Length (Imperial)
 - 8 ft
- Overall Length (Metric)
 - 122 mm

3M™ Dual Airline Front-Mounted Breathing Tube SA-1500/07147(AAD) 1 EA/Case

3M Product Number SA-1500 3M ID 7000002003

Details

Used with the 3M™ Dual Airline Front-Mounted Adapter Kit SA-1000LP, Low Pressure

Typical properties

Brands
3M™
CFM Capacity per Minute
100 CFM, 50 CFM
Facepiece Type
Full Face Respirator
Fitting Type
Industrial Interchange
Material
Vinyl
Mounting Type
Front-Mounted
Pressure Type
Low
Product Color
Black
Product Series
SA-1000
Product Ty

3M™ Dual Airline Back-Mounted Breathing Tube SA-2500/07148(AAD), 1 EA/Case

Part Number 07148 3M Product Number SA-2500 3M ID 7000002006

Details

This tube is part of the 3M™ Back-Mounted Adapter Kit SA-2000LP (low pressure)
Low pressure

Typical properties

Brands
3M™
CFM Capacity per Minute
100 CFM, 50 CFM
Compatible With
3M™ Versaflo™ Air Regulating Valve
Fitting Type
Industrial Interchange
Material
Vinyl
Mounting Type
Back-Mounted
Pressure Type
Low
Product Color
Black
Product Series
SA-20

3M™ Protecta® Equipment Carrying and Storage Bag AK061A, 10 in x 10 in x 18 in

Part Number AK061A 3M Product Number AK061A 3M ID 7012822283

Details

Equipment carrying and storage bag
Size 10 in. x 10 in. x 18 in. (25.4 x 25.4 x 45.7 cm)
Built-in web carrying handles
Heavy-duty zipper
Durable nylon construction with PVC lining
Compact and lightweight design

Typical properties

Brands
PROTECTA®
Case Quantity
1
Connected Safety ID Equipped
No
Dimensions
10.00x10.00x18.00in
Install Type
Reusable
Net Weight (Imperial)
0.6 lb
Net Weight (Metric)
0.3 kg
Product Color
Black
Product Series
PRO™
Product Type
Equipment

3M™ DBI-SALA® Synthetic Horizontal Lifeline System

Details

- Lightweight 11/16 in. (17.5 mm) static kernmantle rope lifeline
- Two 6 ft. (1.8 m) tie-off adaptor anchors included
- Lightweight and portable design
- Built-in energy absorber limits fall arrest forces
- Integral rotary tensioner for easy set-up
- Flexible system capacity of 2 workers
- Various lengths are available to suit job site needs
- Equipped with RFID

Typical properties

Case Quantity

1

Connected Safety ID Equipped

Yes

Install Type

Temporary/Portable

Lifeline Length (Imperial)

20 ft, 30 ft, 40 ft, 50 ft, 60 ft, 70 ft, 80 ft, 90 ft, 100 ft

Lifeline Length (Metric)

6.09 m, 9.14 m, 12.19 m, 15.23 m, 18.28 m, 21.33 m

Dimensions and Classifications

Overall Length (Imperial)

20 ft, 30 ft, 40 ft, 50 ft, 60 ft, 70 ft, 80 ft, 90 ft, 100 ft

Overall Length (Metric)

9 m, 21 m, 30 m

3M™ Protecta® Self-Retracting Lifeline Cover 3590012, Fits 66 - 100 ft Standard and 50 - 66 ft Leading Edge Models

Part Number 3590012 3M Product Number 3590012 3M ID 7100263466

Details

Vinyl cover for Protecta-® self retracting lifelines; 20.1 m - 30.5 m standard cable and 15.2 m - 20.1 m leading edge models

Fast and easy to install

Lightweight and durable

Built-in handle and label access pockets

Designed to fit all DBI-SALA Sealed-Blok™ Retrieval SRL models

Locking pin and mounting bolts included

Typical properties

Brands

PROTECTA®

Case Quantity

1

Connected Safety ID Equipped

No

Product Type

Self Retracting Lifeline Cover

Recommended Industry

Construction, General Industrial, Mining, Oil & Gas, Transportation

Weight (Imperial)

0.34 lb.

3M™ PROTECTA® Compliance in a Can™ Light Roofer's Fall Protection Kit

3M ID B00035927

Details

Complete personal fall arrest system designed for at height applications
Protecta® P50™ harness features pass-thru buckle legs or tongue-buckle legs
PRO™ shock-absorbing lanyards available in single- or twin-leg units
Includes equipment storage bucket with handle for easy transport
Durable materials and hardware stand up to harsh working conditions
Meets the requirements of OSHA 1910.140 and OSHA 1926.502
Recommended for use in the construction industry

Typical properties

eClass 14 Classification Group
15310100

3M™ DBI-SALA® Wood Pole Fall Restricting Device

Details

- Lightweight pole climbing design
- Durable kernmantle rope with wear indicator
- Abrasion resistant sleeve
- One-handed effortless adjustment
- High strength, durable Saflok™ Carabiners
- Stopping cleat and carabiner

Typical properties

- Carabiner/Hook Material
Zinc Plated Steel
- Case Quantity
1
- Connected Safety ID Equipped
No, Yes
- Dimensions
30.5" dia./96" circ. (77.5/244cm), 18.5" dia./58" circ. (47/147cm)
- Harness Connection Type
None
- Lanyard Length (Imperial)
6 ft, 8 ft, 58 in

3M™ DBI-SALA® Sealed-Blok™ 3-Way Retrieval Self-Retracting Lifeline Mounting Bracket 3401025

Part Number 3401025 3M Product Number 3401025 3M ID 7100260274

Details

Spare Parts
Disc Spring
Stainless Steel
Built-in handle and label access pockets
Designed to fit all DBI-SALA Sealed-Blok™ Retrieval SRL models
Locking pin and mounting bolts included

Typical properties

Brands
DBI-SALA®
Case Quantity
1
Connected Safety ID Equipped
No
Product Color
Yellow Zinc
Product Series
Sealed-Blok™
Product Type
Retrieval SRL Mounting Bracket
Recommended Industry
Construction, General Industrial, Mining, Oil & Gas, Trans

3M™ DBI-SALA® Rollgliss™ Sloped Low Speed Automatic Descender Hardware Kit 3302981, Stainless Steel Hook

Part Number 3302981 3M Product Number 3302981 3M ID 7012818834

Details

Hardware kit for sloped low-speed Rollgliss™ descender
Suspension bars connect descender to guide cable
Snap hook for a safe, secure attachment
Compact, lightweight construction
Corrosion-resistant steel construction
Recommended for use in construction, oil and gas, and general industrial applications
4.2 lb. (1.9 kg)

Typical properties

Brands
DBI-SALA®
Case Quantity
1
CoWorker Controlled Ascent
No
CoWorker Controlled Descent
No
Connected Safety ID Equipped
No
Descent Type
Vertical
Maximum Number of Users
One
Net Weight (Imperial)
4.8 lb
Net Weight (Metric)
2.2 kg
Produ

3M™ DBI-SALA® SecuraSpan™ Fasten-in-Place HLL Weld-on Vertical Base

7400222, 1 ea

Part Number 7400222 3M Product Number 7400222 3M ID 7100220297

Details

Bolt-on base for horizontal surfaces provides anchorage point for horizontal lifeline post

Ideal for fasten-in-place system on horizontal steel and concrete structures

Simple attachment with four fasteners (not included)

Heavy-duty portable design

Durable steel construction for strength and longevity

Various lengths and individual components are available

Typical properties

Brands

DBI-SALA®

Case Quantity

1

Connected Safety ID Equipped

Yes

For Use With

3M™ DBI-SALA® SecuraSpan™ Pour-in-Place/Fasten-in-Place HLL system

Install Type

Temporary/Portable

Lifeline Material

Order separately

Maximum Number of Workers

2 P

3M™ DBI-SALA® Confined Space Davit Quick Release Mounting Bracket 8516824

Part Number 8516824 3M Product Number 8516824 3M ID 7100204306

Details

Quick release mounting bracket
Fits confined space upper and lower masts
Durable powder coated aluminum construction
Compact and lightweight design

Typical properties

Brands
DBI-SALA®
Case Quantity
1
Connected Safety ID Equipped
No
Dimensions
2.70x3.50x5.00in
Net Weight (Imperial)
1.5 lb
Net Weight (Metric)
0.7 kg
Product Series
Advanced™
Product Type
Davit Quick Release Mounting Bracket
Recommended Ind

Dimensions and Classifications

Overall Height (Imperial)
5 in
Overall Height (Metric)
12.7 cm

3M™ DBI-SALA® Confined Space Top Pulley Assembly For UCT Tripod 8512293

Part Number 8512293 3M Product Number 8512293 3M ID 7100260273

Details

Top pulley assembly for confined space UCT series tripods
Accommodates up to 1/4" (6.3 mm) diameter lifeline
Fits confined space 8513158 and 8513159 tripods
Simple detent pin style lifeline retention
Durable powder coated steel construction
Compact and lightweight design

Typical properties

Brands
DBI-SALA®
Case Quantity
1
Connected Safety ID Equipped
No
For Use With
UCT Series Tripods
Net Weight (Imperial)
1.5 lb
Net Weight (Metric)
0.7 kg
Product Color
Black
Product Type
Confined Space Pulley
Recommended Industry
Construct

3M™ DBI-SALA® SSB Cable Climb Assist System Counterweight 3511598, Galvanized Steel, 80 lb

Part Number 3511598 3M Product Number 3511598 3M ID 7100268945

Details

Constructed of aluminum housing and steel drum
Designed for use in rugged environments
No limit of system length

Typical properties

Attachment Type
User Supplied 1/2" (12.7 mm) Guy Wire
Brands
DBI-SALA®
Case Quantity
1
Connected Safety ID Equipped
No
Dimensions
6 in x 12 in x 36 in
Install Type
Permanent
Maximum Number of Users
One
Net Weight (Imperial)
82 lb
Net Weigh

3M™ H-700 Series Hard Hat Systems

3M ID B10434507

Details

Suspension sits lower on the head for a balanced fit that helps reduce pressure and increase security

Metal mesh faceshield provides ventilation and face protection

3M™ PELTOR™ Ear muff features earcup pivot points for comfort and efficiency

Hard Hat Sealer helps keep debris and water from falling behind visor

Durable materials and hardware stand up to harsh working conditions

Meets the requirements of ANSI Z87.1 for Occupational and Educational

Personal Eye and Face Protection Devices and ANSI Z89.1 for Industrial Head Protection

Typical properties

eClass 14 Classification Group

40300202

3M™ Hood Insert RBE-FIH 1 EA/Case

3M Product Number RBE-FIH 3M ID 7010341609 UPC 00051131989290

Details

Protective foam insert for improved storage of the 3M™ Breathe Easy™ Hood BE-10

Typical properties

Brands

3M™

Headgear Type

Hood

Product Series

Breathe Easy

Product Type

Headgear

3M™ Versaflo™ Air-Flow Adjustment Cover for Premium Head Suspension, S-955, 1 EA/Ccase

3M Product Number S-955 3M ID 7100010623

Details

For use with S-950 Premium Head Suspension

When used properly, allows user to adjust the location of the airflow in the hood

Typical properties

Brands

Versaflo™

Compatible With

3M™ Premium Head Suspension, S-950

Headgear Type

Hood

High Heat

No

Product Color

Blue

Product Series

S-Series

Product Type

Headgear Cover

Recommended Industry

Marine

3M™ PELTOR™ X5 Earmuffs

Details

31 dB Noise Reduction Rating (NRR)
Earcup pivot points tilt for optimum comfort and efficiency
Slow-recovery, high-density foam
Replaceable ear cushions and foam liners (hygiene kit HYX5)
3M™ E-A-Rfit™ Dual-Ear Validation System testable

Typical properties

Attenuation Rating
31.0 Decibel
Attenuation Rating (SNR)
31 Decibel
Bluetooth
No
Case Quantity
10
Corded
No
Dielectric
No, Yes
Earmuff Style
Behind the Head, Hard Hat Attached, Over the Head
Electrically Insulated
No, Yes
Features
Dual Mo

3M™ Self-Retracting Lifeline Fast Line Drum Lock Tool 9600037

3M Product Number 9600037 3M ID 7100311233

Details

Spare Parts

Disc Spring

Stainless Steel

Built-in handle and label access pockets

Designed to fit all DBI-SALA Sealed-Blok™ Retrieval SRL models

Locking pin and mounting bolts included

3M™ E-A-Rsoft™ Grippers™ Earplugs 312-6001, Corded, 2000 Pair/Case

3M Product Number 312-6001 3M ID 7000127654 UPC 10080529120905

Details

Soft, pliable foam offers comfort for wearing over an extended time
Unique grip rings help create a soft, noise-blocking seal
Earplug design offers effective hearing protection for people with larger earcanals
Slow recovery foam effectively seals the earcanal and provides reliable hearing protection
Noise Reduction Rating (NRR) of 31 dB, CSA Class AL

Typical properties

Attenuation Rating
31.0 Decibel
Banded
No
Brands
3M™
Case Quantity
2000
Cord Color
Blue
Cord Material
Vinyl
Cord Type
Vinyl
Corded
Yes
Dielectric
No
Dispenser Available
No
Earplug Color
Yellow
Earplug Material
Foam
Earplug Shape
B

3M™ Hard Hat Front Visor Seal GR2B-10P 10 EA/Case

3M Product Number GR2B-10P 3M ID 7000103819 UPC 10093045936271

Details

helps to keep water and debris from falling behind faceshield
water-resistant
Use with 3M™ V Series faceshields

Typical properties

Brands

3M™

Case Quantity

10

Compatible Hard Hat

H-700, H-700T, V-Series Face Shield, X5000

For Use With

3M™ Headgear Systems, V1 Series Visors, V2 Series Visors, V3 Series Visors

High Heat

Yes

Material

Nylon

Product Color

Orange

Product Type

Dimensions and Classifications

Overall Height (Imperial)

5.5 in

Overall Height (Metric)

13.97 cm

Overall Length (Imperial)

2.5 in

Overall Length (Metric)

6.35 cm

Overall Width (Imperial)

0.5 in

Overall Width (Metric)

1.27 cm

**3M™ Versaflo™ Air Duct Sealing Ring for Premium Head Suspension
S-956, 5
EA/Case**

3M Product Number S-956 3M ID 7000127440 UPC 00051131373082

Details

For use with S-950 Premium Head Suspension
Installed on section where air enters the suspension

Typical properties

Brands
Versaflo™
Compatible With
3M™ Premium Head Suspension, S-950
Headgear Type
Hood
High Heat
No
Product Color
Black
Product Series
S-Series
Product Type
Air Duct Sealing Ring
Recommended Industry
Marine

3M™ Hatshell W-3258-5/07039(AAD) 5 Hatshells/Case

3M Product Number W-3258-5 3M ID 7000131000 UPC 50051131070399

Details

For use with 3M™ Hoods H-Series

Typical properties

Brands

3M™

Compatible With

3M™ H-Series Headgear

Headgear Type

Hood

High Heat

No

Product Color

White

Product Series

H-Series

Product Type

Headgear Shell

Recommended Industry

Marine

eClass 14 Classification Group

46080105

3M™ Cartridge Washer W-2923 1 EA/Case

3M Product Number W-2923 3M ID 7010318167 UPC 00051138155605

Details

Used with the 3M™ Compressed Air Filter and Regulator Panel W-2806

Typical properties

Brands

3M™

CFM Capacity per Minute

100 CFM, 50 CFM

Product Color

Metal

Product Series

Supplied Air

Product Type

Washer

Supplied Air Respirator Style

W-Series Fixed Panels

3M™ E-A-R™ Skull Screws™ Earplugs

Details

Tough look of threaded metal

Ultra soft foam tips feel comfortable for extended wear

Noise reduction rating (NRR)*: 32 dB

Unique shape and color appeals to some users to help with compliance

Available with or without cords to suit user preference

CSA Class AL

*U.S. EPA specifies the NRR as the measure of hearing protector noise reduction. However, 3M makes no warranties as to the suitability of the NRR for this purpose. 3M strongly recommends personal fit testing of hearing protectors. Research suggests that users may receive less noise reduction than indicated by the attenuation label value(s) on the packaging due to variation in fit, fitting skill, and motivation of the user. Refer to applicable regulations or guidance on how to adjust attenuation label values. It is recommended that the NRR be reduced by 50% to better estimate typical protection

Typical properties

Attenuation Rating

32.0 Decibel

Banded

No

Case Quantity

480 Pair

Cord Color

Gray

Cord Type

None, Vinyl

Corded

No, Yes

Dielectric

No

Dispenser Available

No

Earplug Color

Gray

Earplug Material

Foam/Thermoplastic

Earplug Shape

Cone

Earp

3M™ PELTOR™ X1/X2 Earmuff Probed Test Cushions 393-3001-2, 2 EA/Case

3M Product Number 393-3001-2 3M ID 7100062126 UPC 00078371668341

Details

Easily snaps into employee's own earmuffs enabling fit test. Adapter clips hold microphone next to earmuff for proper positioning during testing
Probed cushions can be cleaned with hygiene wipes and reused
Adapter clips hold microphones next to earmuffs during testing
*The NRR may overestimate the hearing protection provided during typical use

Typical properties

Brands

PELTOR™

Case Quantity

2

Product Color

Black

Product Series

X Series

Product Type

Probed Test Cushion

Recommended Application

Health & Safety Testing

Recommended Industry

Automotive, Commercial Buildings, Construction, Design & Construc

3M™ 2097 Performance P100 Particulate + Odor Filters for the 3M™ Mold and Lead Paint Removal Respirator

3M ID 70006994852 UPC 00051141928579

Details

INTENDED FOR THE PROFESSIONAL removal of mold, lead-based paints, woodworking and working with fiberglass insulation

APPROVED FOR USE WITH 3M™ 6000, 6500 AND 7500 SERIES FACEPIECES

CARBON LAYER helps reduce the odor of nuisance organic vapors such as certain solvents, degreasers, and resins* (*3M recommended for relief against nuisance level organic vapors. Nuisance levels are less than OSHA PEL or applicable government occupational exposure limits, whichever is lower.)

EASY-TO-ATTACH DESIGN

Facepiece is not included

Color: magenta

Use this product in accordance with all applicable respiratory protection requirements including OSHA Lead Standard and US-EPA Guidelines for mold

WARNING: Workplace/Occupational Applications: This respirator helps protect against certain airborne contaminants. Misuse may result in sickness or death.

For correct use, consult supervisor and User Instructions, or call 3M in USA at 1-800-243-4630. In Canada, call 1-800-267-4414

Typical properties

Brands

3M™

Catalog Number

2097H2-DC

Factory ISO Certification

No ISO Certification information available

eClass 14 Classification Group

40220213

3M™ Aura™ Particulate Respirators 9200+ Series

Details

Unique three-panel design fits a wide range of face shapes/sizes and accommodates facial movements while talking
Sculpted top panel helps conform to nose and eye contours, allowing more room for eyewear
Embossed top panel directs exhaled air away from the nose panel, helping reduce eyewear fogging
Individual packaging helps protect the respirator from contamination
Flat fold design offers convenient storage and portability
Innovative chin tab designed for ease of positioning, donning & adjustment
Soft nose foam and smooth inner materials feel comfortable against skin
Adjustable noseclip helps provide a custom and secure seal
3M proprietary filter media designed for easy breathing
Available with braided headbands to help keep respirator securely in place and minimize pulling of hair
Some models available with 3M(TM) Cool Flow(TM) Comfort Valve to help release warm, moist exhaled breath from inside the respirator
NIOSH approved for at least 95 percent filtration efficiency against certain non-oil based particulates
Collapse resistant and compatible with a variety of eyewear
Patented. See 3M.com/patent

Typical properties

Acid Gas Reduction
No
Advanced Electrostatic Media
Yes
Braided Comfort Strap
No, Yes
Cake-Resistant Filter Media
No
Class
Comfort, Comfort Plus
Cool Flow™ Exhalation Valve
No, Yes
Enhanced Comfort
No
Environment - Hot or Humid
Yes
Exhalati

3M™ PELTOR™ Hygiene Cleaning Pads, 100 Pads / Pack, HY100A

3M Product Number HY100A 3M ID 7100064410 UPC 07318640048362

Details

Disposable covers for the ear cushions that are intended to provide a clean contact surface when the headset is used by multiple people
Supplied in a pack of 100 pairs

Typical properties

Brands

PELTOR™

Case Quantity

100

Compatible Earmuff

All PELTOR Headsets

Product Color

Brown

Product Type

Cleaning Pads

Recommended Industry

Agriculture, Automotive, General Manufacturing, Metal Fabrication, Military Maintenance, Repair & Operat

3M™ Safety Eyewear, Gray Frame, Gray lens

3M ID 70006997020 UPC 00076308723934

Details

Durable lenses help provide limited protection from light to moderate impact hazards

Contoured design

Lightweight – weighs less than 1 ounce

Scratch-resistant coating helps keep vision clear

Impact-resistant lenses block 99.9% of UV rays

Meets the requirements of ANSI Z87.1

Gray lenses help reduce sunlight and are popular for outdoor use

Lens Color: Gray

Quantity:4

Typical properties

Brands

3M™

Catalog Number

90954H4-DC

Factory ISO Certification

No ISO Certification information available

Frame Material

Polycarbonate

Frame Style

Wraparound

Material

Polycarbonate

Product Color

Gray

Sealed Eyewear

No

Splash Protection

No

Dimensions and Classifications

Overall Height (Imperial)

4 in

Overall Height (Metric)

101.6 mm

Overall Length (Imperial)

2.375 in

Overall Length (Metric)

60.33 mm

Overall Width (Imperial)

8.5 in

Overall Width (Metric)

215.9 mm

3M™ Safety Eyewear, Gray Frame, Gray lens

3M ID 70006987971 UPC 00051141332192

Details

Durable lenses help provide limited protection from light to moderate impact hazards

Contoured design

Lightweight – weighs less than 1 ounce

Scratch-resistant coating helps keep vision clear

Impact-resistant lenses block 99.9% of UV rays

Meets the requirements of ANSI Z87.1

Gray lenses help reduce sunlight and are popular for outdoor use

Lens Color: Gray

Quantity:4

Typical properties

Brands

3M™

Catalog Number

90954H1-DC-20

Factory ISO Certification

No ISO Certification information available

Frame Material

Polycarbonate

Frame Style

Wraparound

Hard Coat Lens

No

Material

Polycarbonate

Sealed Eyewear

No

Splash Protection

Dimensions and Classifications

Overall Height (Imperial)

4 in

Overall Height (Metric)

101.6 mm

Overall Length (Imperial)

2.375 in

Overall Length (Metric)

60.33 mm

Overall Width (Imperial)

8.5 in

Overall Width (Metric)

215.9 mm

3M™ Outdoor Safety Eyewear, Gray Frame, Gray Scratch Resistant Lenses

3M ID 70006947405 UPC 00078371113278

Details

Weighs less than 1 oz
Wraparound frame design
Anti-scratch lens coating
Impact-resistant lenses absorb up to 99.9% UV
Meets the requirements of ANSI Z87.1-2010

Typical properties

Anti Fog Lens
Yes
Brands
3M™
Catalog Number
90954-BU10-NA
Diopter
0
Factory ISO Certification
No ISO Certification information available
Frame Material
Polycarbonate
Frame Style
Wraparound
Gasket Included
No
Hard Coat Lens
No
Product Ser

Dimensions and Classifications

Overall Height (Imperial)
1.9 in
Overall Height (Metric)
4.826 cm
Overall Length (Imperial)
1.7 in
Overall Length (Metric)
4.318 cm
Overall Width (Imperial)
5.9 in
Overall Width (Metric)
14.986 cm

3M™ SecureFit™ Hard Hat Vented Cap Style with Ratchet Adjustment, White, 1 Ea/Pk

3M ID 70007082863 UPC 00051131226708

Details

Patented 3M™ Pressure Diffusion Technology incorporates self-adjusting front paddles along your forehead
Suspension flexes and self-adjusts, reducing forehead pressure and increasing comfort for all-day wear
Smooth-turning 4-point ratchet suspension system for custom, on-head sizing
Suspension sits low on the head to increase comfort and security
Customize your fit with multiple levels of height and head-shape adjustments
Fits hat sizes 6 ¼ to 8 (50 to 64cm head circumference)
Breathable, washable sweatband – to help keep you cool and dry
Vented design allows for more airflow
Cap style hard hat is ANSI compliant when worn forward or reverse
Made in USA with globally sourced materials
Made in USA with globally sourced materials

Typical properties

Brands
3M™
Factory ISO Certification
No ISO Certification information available
eClass 14 Classification Group
40300202

3M™ Combination Dual Airline Back-Mounted Breathing Tube SA-2600/37001(AAD) 1 EA/Case

Part Number 37001 3M Product Number SA-2600 3M ID 7000002044

Details

Used on both the high and low pressure back-mounted combination kits

Typical properties

Brands

3M™

CFM Capacity per Minute

100 CFM, 50 CFM

Compatible With

3M™ Supplied Air Systems

Fitting Type

Industrial Interchange

Material

Vinyl

Mounting Type

Back-Mounted

Pressure Type

High

Product Color

Black

Product Series

SA-2000

Produ

3M™ Combination Dual Airline Front-Mounted Breathing Tube SA-1600, 1 Ea/Case

3M Product Number SA-1600 3M ID 7000002043

Details

Used on both the high and low pressure front-mounted combination kits
Front-mounted combination breathing tube type

Typical properties

Brands
3M™
CFM Capacity per Minute
100 CFM, 50 CFM
Fitting Type
Industrial Interchange
Material
Vinyl
Mounting Type
Front-Mounted
Pressure Type
High
Product Color
Black
Product Series
SA-1000
Product Type
Breathing Tubes
Purpose
PAPR, P

3M™ Vortemp™ Holder Kit W-3017 1 EA/Case

3M Product Number W-3017 3M ID 7000130754 UPC 00051138164157

Details

W-3017 Vortemp Holder Kit

Typical properties

Brands
Vortemp™
CFM Capacity per Minute
50 CFM
Product Color
Brown
Product Series
Whitecap
Product Type
Holder Kit
Supplied Air Respirator Style
W-Series Fixed Panels
Valve Type
Cooling / Heating Valve

3M™ Vortex Holder Kit W-3016 1 EA/Case

3M Product Number W-3016 3M ID 7000130753 UPC 00051138164126

Details

Used with the 3M™ Vortex Cooling Assembly W-2862SR

Typical properties

Brands

3M™

CFM Capacity per Minute

50 CFM

Case Quantity

1

Product Color

Brown

Product Series

Whitecap

Product Type

Holder Kit

Recommended Application

Composite Finishing, Final Finish, Paint Preparation, Painting, Welding

Supplied Air Respir

3M™ Versaflo™ Replacement Airflow Deflector M-116, for M-100 Face Shields, 1 EA/Case

3M Product Number M-116 3M ID 7000127600 UPC 00051131173132

Details

Replacement part for 3M™ Versaflo™ M-100 Series Faceshields

Typical properties

Brands

Versaflo™

Case Quantity

1

Compatible With

3M™ Versaflo™ M-100 Faceshield

Headgear Type

Headtop with clear visor

High Heat

No

Product Color

Blue

Product Series

M-Series

Product Type

Airflow Deflector

3M™ Versaflo™ Replacement Airflow Deflector M-316, for M-300 and M-400 Series Hard Hats and Helmets, 1 EA/Case

3M Product Number M-316 3M ID 7000127678 UPC 00051131173187

Details

Replacement part for 3M™ Versaflo™ M-300 Series Hardhats and M-400 Series Helmets

Typical properties

Brands
Versaflo™
Case Quantity
1
Compatible With
3M™ Versaflo™ M-400 Series Helmets
Headgear Type
Hardhat with Faceshield
High Heat
No
Product Color
Blue
Product Series
M-Series
Product Type
Airflow Deflector

3M™ Air Deflector W-2924 1 EA/Case

3M Product Number W-2924 3M ID 7010348307 UPC 00051138159054

Details

Used with the 3M™ Compressed Air Filter and Regulator Panel W-2806

Typical properties

Brands

3M™

CFM Capacity per Minute

100 CFM, 50 CFM

Product Color

White

Product Series

Supplied Air

Product Type

Air Deflector

Supplied Air Respirator Style

W-Series Fixed Panels

3M™ Manifold W-3079 1 EA/Case

3M Product Number W-3079 3M ID 7010319417 UPC 00051138293680

Details

Used with the 3M™ Compressed Air Filter and Regulator Panel W-2806

Typical properties

Brands

3M™

Compatible With

3M™ W-2806 Filtration Panel

Product Type

Manifold

3M™ Versaflo™ Breathing Tube Cover BT-922/W-3228-10/37311(AAD), 10 EA/Case

Part Number 37311 3M Product Number BT-922/W-3228-10 3M ID 7100077588

Details

Can be used to protect the tube and extend the life
Designed to cover the 3M™ Versaflo™ BT-Series Breathing Tubes

Typical properties

Brands
Versaflo™
Compatible With
3M™ Versaflo™ BT-Series Breathing Tube, 3M™ Versaflo™ TR-300 Series
PAPR
Material
Plastic
Product Color
Transparent
Product Series
BT Series
Product Type
Breathing Tubes
Purpose
PAPR, Parts and Accessories, SA

3M™ Versaflo™ Breathing Tube Radiant Heat Cover BT-927N, 1 EA/Case

3M Product Number BT-927N 3M ID 7100154106 UPC 00076308942762

Details

Radiant heat resistant
Modular
Breathing tube cover
Protects against radiant heat

Typical properties

Brands
Versaflo™
Compatible Respirator Type
SAR
Compatible With
3M™ Versaflo™ BT-Series Breathing Tube
Coupling Size
0.25" MPT, 3/8" Body Size, Industrial Interchange
Headgear Type
Headcover
High Heat
Yes
Material
Aluminized Fabric
Product C

3M™ Versaflo™ TR-300N+ Series PAPR Filter Cover TR-371+ 1 EA/Case

3M Product Number TR-371+ 3M ID 7100156020 UPC 00051131277045

Details

Compatible with TR-300+ PAPR System
Window allows users to see filter label
Replacement part
For particulate environments

Typical properties

Brands
Versaflo™
Breathing Tube Type
Back-Mounted
Case Quantity
1/case
Compatible With
3M™ Versaflo™ TR-300 Series PAPR, 3M™ Versaflo™ TR-300N+ Series PAPR
Headgear Type
Head Cover with Suspension
Intrinsically Safe
No
Mounting Type
Belt-moun

3M™ Adflo™ Filter Cover 35-1099-81

3M Product Number 35-1099-81 3M ID 7100200482 UPC 00076308943691

Details

Adflo Filter Cover
Replacement Part
See resources section below

Typical properties

Brands
Adflo™
Case Quantity
1
Compatible With
3M™ Adflo™ PAPR
Features
Respiratory Spare Part
Product Series
Adflo
Product Type
Replacement Parts & Accessories
Recommended Application
Assembly, Facility Maintenance, Grinding, Machine Operatio

3M™ Versaflo™ Filter Cover TR-6700FC/37356(AAD), for TR-6710N Filter, 1 EA/Case

3M Product Number TR-6700FC 3M ID 7100021251

Details

- Easy to use
- Helps protect cartridge from physical damage
- Enables use of prefilters and/or spark arrestors
- Enables PAPR to be worn through decontamination showers or rain

Typical properties

- Brands
 - Versaflo™
- Case Quantity
 - 1/case
- Compatible With
 - 3M™ Versaflo™ TR-600 Series PAPR
- Hazard Type
 - Silica
- Intrinsically Safe
 - Yes
- Net Weight (Metric)
 - 61 g
- Product Series
 - TR-600
- Product Type
 - Filter Cover
- Recommended Application
 - Assembly & M

Dimensions and Classifications

- Overall Height (Metric)
 - 0.093 m
- Overall Length (Metric)
 - 0.261 m
- Overall Width (Metric)
 - 0.132 m

3M™ Scott™ ELSA Emergency Escape Breathing Device

3M ID B5005270001

Details

Clear hood with 360° visibility and patent pending neck seal fits all wearers (study available)

The clear hood with patent-pending neck seal fits all wearers*, and pulls on with no additional steps to secure, making it easy to train and use properly

Fully enclosed carry bag helps keep the respirator clean and free of insects and debris

Large 3" pull tab and one step pull-to-open aids in quick donning, even in low visibility conditions

Integrated handle and adjustable carry strap enables carrying in multiple ways

3 year warranty

Typical properties

Brands

Scott™

Cylinder Material

Aluminum

3M™ Exhalation Valve Assembly FF-400-07, 5 EA/Case

3M Product Number FF-400-07 3M ID 7000052738 UPC 50051135894793

Details

A system component to use with 3M Ultimate FX Full Facepiece Reusable Respirators FF-401, FF-402, and FF-403 (sold separately)
Assembly includes a mounting seat and 3M™ Cool Flow™ valve
Maintains original performance standards of facepiece
Includes mounting seat and 3M Cool Flow valve
Replaceable part can potentially result in respiratory equipment cost savings

Typical properties

Accessories
Yes
Boxes per Case
5
Brands
3M™
Case Quantity
5/case
Clip-on Welding Shield
No
Compatible Respirator
FF-400 Series
Compatible with 3M™ PAPR Systems
No
Compatible with 3M™ Supplied Air System
Yes
Compatible with Welding Shield

3M™ Replacement Filter Kit 523-01-29 1 EA/Case

Part Number 72010 3M Product Number -502909 3M ID 7000056891

Details

Replacement filter kit for 3M™ Portable Compressed Air Filter and Regulator
Panel 256-02-01

Typical properties

Brands
3M™
CFM Capacity per Minute
100 CFM, 50 CFM
Case Quantity
1/case
Compatible Respirator
256-02-01
Product Color
White
Product Series
Supplied Air
Product Type
Filter Kit
Protection Type
Particulate
Recommended Application
Assembly &

3M™ Replacement Filter Kit 523-01-28 1 EA/Case

3M Product Number -502910 3M ID 7100006947

Details

Replacement filter for 3M™ Portable Compressed Air Filter and Regulator Panel
256-02-00

Typical properties

Brands

3M™

CFM Capacity per Minute

100 CFM, 50 CFM

Compatible Respirator

256-02-01

Product Color

White

Product Series

Supplied Air

Product Type

Filter

Protection Type

Particulate

Recommended Application

Assembly & Mechanical, Blasting, Clea

3M™ Secure Click™ Exhalation Valve Cover Assembly FF-800-04, 5 ea/Case

3M Product Number FF-800-04 3M ID 7100267864 UPC 00638060432259

Details

Cover protects exhalation valve
Replaceable part can potentially result in respiratory equipment cost savings

Typical properties

Accessories

Yes

Brands

Secure Click™

Case Quantity

5

Compatible Respirator

FF-800 Series, Secure Click™ HF-800 Series Full Facepiece Reusable Respirators

Compatible with 3M™ PAPR Systems

No

Compatible with 3M™ Supplied Air System

No

Enhanced C

Dimensions and Classifications

Overall Height (Imperial)

8.036 in

Overall Height (Metric)

204.103 mm

Overall Length (Imperial)

8.036 in

Overall Length (Metric)

204.103 mm

Overall Width (Imperial)

8.036 in

Overall Width (Metric)

204.103 mm

3M™ Full Face Paint Project Respirator 69P71 (Large)

3M ID 70006985637 UPC 00051138660574

Details

FULL FACE RESPIRATOR helps deliver comfort while providing eye and face protection

FOR WORKPLACE/OCCUPATIONAL USE ONLY

KIT CONTENTS: one facepiece, one pair of replaceable 6001 cartridges, one pair of 501 retainers and two pairs of replaceable 5P71 filters

WIDE FIELD OF VIEW for visibility while providing face and eye protection

SOFT SILICONE FACESEAL for excellent comfort

FOUR STRAPS create a balanced and comfortable feel on the head

ADJUSTABLE DESIGN helps you achieve a personalized fit

CONVENIENT, RESUABLE DESIGN

DURABLE DESIGN for lasting wear

3M™ BAYONET CONNECTION compatible with a wide range of 3M™ cartridges and filters

Replacement cartridges and filters available for economic repeat use of the facepiece

Replacement lens covers available (Cat# 6885)

Contains no components made from natural rubber latex

Size: Large

WARNING: Workplace/Occupational Applications: Use under a government-compliant respiratory protection program (e.g., OSHA). This respirator helps protect against certain airborne contaminants. Misuse may result in sickness or death. For correct use, consult supervisor and User Instructions, or call 3M in USA at 1-800-243-4630. In Canada, call 1-800-267-4414

Typical properties

Brands

3M™

Factory ISO Certification

No ISO Certification information available

Suspension Type

4 Point Strap

eClass 14 Classification Group

40220113

3M™ Full Face Paint Project Respirator 68P71 (Medium)

3M ID 70006986320 UPC 00051138660567

Details

FOR WORKPLACE/OCCUPATIONAL USE ONLY

NIOSH-APPROVED 5P71 P95 RATER FILTER HELPS REDUCE EXPOSURE to certain particles from paint spraying*, spray adhesives and pesticides**
FULL FACE RESPIRATOR helps deliver comfort while providing eye and face protection

FOR WORKPLACE/OCCUPATIONAL USE ONLY

KIT CONTENTS: one facepiece, one pair of replaceable 6001 cartridges, one pair of 501 retainers and two pairs of replaceable 5P71 filters

WIDE FIELD OF VIEW for visibility while providing face and eye protection

SOFT SILICONE FACESEAL for excellent comfort

FOUR STRAPS create a balanced and comfortable feel on the head

ADJUSTABLE DESIGN helps you achieve a personalized fit

CONVENIENT, RESUABLE DESIGN

DURABLE DESIGN for lasting wear

3M™ BAYONET CONNECTION compatible with a wide range of 3M™ cartridges and filters

6001 OV CARTRIDGE HELPS REDUCE EXPOSURE to certain organic vapors encountered during activities involving latex and oil-based painting, including paint spraying*, varnishes, stains, sealants, solvents, certain solvent-based cleaners or pesticides**. *Use a prefilter when spraying **Refer to Pesticide Product Label for Respirator Guidance or call 3M at 1-800-243-4630 or In Canada, call 1-800-267-4414

5P71 FILTER HELPS REDUCE EXPOSURE to certain particles from paint spraying*, spray adhesives and pesticides**. *Use a prefilter when spraying **Refer to Pesticide Product Label for Respirator Guidance or call 3M at 1-800-243-4630 or In Canada, call 1-800-267-4414

KIT CONTENTS: one facepiece, one pair of replaceable 6001 cartridges, one pair of 501 retainers and two pairs of replaceable 5P71 filters

Typical properties

Brands

3M™

Factory ISO Certification

No ISO Certification information available

Suspension Type

4 Point Strap

eClass 14 Classification Group

40220113

3M™ Speedglas™ 9100 Series Auto-Darkening Welding Filters

Details

- Delivers minimal distortion across the entire filter viewing area
- Includes proven arc detection electronics
- Features grinding and cutting modes
- Selectable Shades 5, 8-13
- Helps reduce eye strain

Typical properties

- ADF Dark State Shades
Variable 5, 8-13
- ADF Model
9100V, 9100X, 9100XX, 9100XXi
- ADF Shade Range
Variable 5, 8-13
- ADF Viewing Area (Metric)
45 mm x 93 mm, 54 mm x 107 mm, 73 mm x 107 mm
- ADF Viewing Area (hwx)
1.8x3.7in, 2.1x4.2in, 2.8x4.2in
- Auto O

3M™ Bayonet Cap 6880/37002(AAD), 10 ea/Bag

Part Number 37002 3M Product Number 6880 3M ID 7100006233

Details

Approved 3M system component
Designed to close bayonet attachments on 3M Full Facepieces
Designed to close bayonet attachments on 3M Combination Dual Airline Breathing Tubes
Provides an effective closure to route airflow through separate path
Black

Typical properties

Boxes per Case
10
Brands
3M™
Case Quantity
10/case
Compatible Respirator
6000 Series
Compatible with 3M™ PAPR Systems
No
Compatible with 3M™ Supplied Air System
Yes
Connection Type
Bayonet
Eye Protection
No
Facepiece Type
Full Facepiece R

3M™ Dual Cartridge Respirator Assembly 07191, Organic Vapor/P95, Small

Part Number 07191 3M ID 7000126245 UPC 00051131071919

Details

Organic vapor cartridges are permanently attached
Packout includes: facepiece with cartridges plus 1 pair of filter retainers 07054,
and 1 pair of P95 filters 07194
Spray paint applications
For occupational use only

Typical properties

Brands
3M™
Connection Type
Permanent
Facepiece Material
Thermoplastic Elastomer (TPE)
Mask Size
Small
Recommended Industry
Marine
Replaceable Cartridge Included
Yes
eClass 14 Classification Group
40220112

3M™ Virtua™ CCS Protective Eyewear with Foam Gasket, VC225AF Clear +2.5D Anti-Fog Lens, 20 ea/Case

3M Product Number VC225AF 3M ID 7100046673 UPC 10078371662711

Typical properties

ANSI Requirements

ANSI Z87.1-2003 and CSA Z94.3-2007

Anti Fog Lens

Yes

Brands

Virtua™

Case Quantity

20

Class

Premium

Comfort Features

Color-accented temples, Comfortable Wraparound Frame, Contains Foam Gasket, Cord Control System, Sporty wrapar

Dimensions and Classifications

Overall Height (Imperial)

9.25 in

Overall Height (Metric)

23.495 cm

Overall Length (Imperial)

9.25 in

Overall Length (Metric)

23.495 cm

Overall Width (Imperial)

4.5 in

Overall Width (Metric)

11.43 cm

3M™ Virtua™ CCS Protective Eyewear with Foam Gasket, VC215AF Clear +1.5D Anti-Fog Lens, 20 ea/Case

3M Product Number VC215AF 3M ID 7100046796 UPC 10078371662698

Typical properties

ANSI Requirements

ANSI Z87.1-2003 and CSA Z94.3-2007

Anti Fog Lens

Yes

Brands

Virtua™

Case Quantity

20

Class

Premium

Comfort Features

Color-accented temples, Comfortable Wraparound Frame, Contains Foam Gasket, Cord Control System, Sporty wrapar

Dimensions and Classifications

Overall Height (Imperial)

9.25 in

Overall Height (Metric)

23.495 cm

Overall Length (Imperial)

9.25 in

Overall Length (Metric)

23.495 cm

Overall Width (Imperial)

4.5 in

Overall Width (Metric)

11.43 cm

3M™ Protecta® P200 Safety Harness

Details

Available in a variety of standard, comfort, and hot works configurations
Standard and Comfort P200 Harnesses are equipped with a fixed dorsal D-ring to help reduce the need for readjustment throughout the workday
Select models available with web pSRL adapter to enable attachment of personal self-retracting lifelines
Integrated suspension trauma straps included on most models
Includes integrated auto-setting lanyard keepers
Durable polyester web construction

Typical properties

Belly Pad

No

Belt

Without

Board/Seat Cushion

No

Body Belt

No, Yes

Brands

PROTECTA®

Buckle Type

Parachute, Pass-through, Quick Connect, Tongue Buckle, Tongue and Grommet Buckle

Case Quantity

1,1 EA/Case

Chest Buckle Material

Zinc Plated Stee

3M™ Speedglas™ G5-01 Inner Grinding Visor Frame, 46-0700-64, 1 EA/Case

3M Product Number 46-0700-64 3M ID 7100214394 UPC 00076308944629

Details

Replacement spare part covering the inner grinding visor
For maximum safety and comfort, make it a habit to check your equipment regularly
Replace worn out or damaged parts
For use with 3M™ Speedglas™ Welding Helmets

Typical properties

Brands
Speedglas™
Compatible Welding Helmet
G5-01 Welding Helmets
Product Color
Black
Product Series
G5
Product Type
Visor Frame
Recommended Application
Grinding, Metal Processing, Metal Repair, Welding
Recommended Industry
General Manufactur

3M™ Speedglas™ 9000 Welding Helmet Front Panel 04-0212-02NC, 1 EA/Case

3M ID 7100140486 UPC 00051131276109

Details

Precision optics., which provide a view that appears lighter, brighter and more realistic, giving you better control of the weld puddle
A more comfortable suspension for longer wear time
Lighter weight Better for longer wearing, just 17oz
Slim fit, better for tight spots
Simplified UI, easy to operate and Maintain

Typical properties

ADF Shade Range

None

ADF Viewing Area (hwxw)

2.13x4.09in

Brands

Speedglas™

Case Quantity

1

Compatible Welding Helmet

9000 Series

For Use With

3M™ Speedglas™ Welding Helmet 9002NC 04-0100-20NC

Headgear Type

Faceshields

Includes

Helmet shield,

3M™ Probed Particulate Respirator 8233Q, N100 20 EA/Case

3M Product Number 8233Q 3M ID 7010315854 UPC 50051138660845

Details

For quantitative fit testing ONLY

Not to be used for respiratory protection in a contaminated area

For Occupational Use only

Typical properties

Acid Gas Reduction

No

Aerosol Type

Non-Oil

Assigned Protection Factor

10

Brands

3M™

Case Quantity

20

Compatible With

Disposable Respirators

Exhalation Valve

Yes

FDA Cleared

No

Filter Class

N100

Flame Resistance (ASTM D2859-96)

No

Fluid

3M™ Speedglas™ 100 Series Front Frame 07-0212-00SV, Silver, 1 EA/Case

3M Product Number 07-0212-00SV 3M ID 7000127445 UPC 00051131171572

Details

Silver

Replacement Part

Replace worn out or damaged parts, if any pits, scratches or damages occur

For use with 3M™ Speedglas™ Welding Helmets

Typical properties

Brands

Speedglas™

Case Quantity

1

Compatible Welding Helmet

100 Series

Features

100 Series Accessory

Headgear Type

Welding Helmet

Product Series

100

Recommended Application

Assembly, Facility Maintenance, Grinding, Machine Operation, Sanding,

**3M™ Speedglas™ 9100 Welding Helmet Front Panel 06-0300-55,
Silver, 1
EA/Case**

3M Product Number 06-0300-55 3M ID 7000128243 UPC 00051131494947

Details

Silver Front Panel
Replacement Part
9100 Series
For use with 3M™ Speedglas™ Welding Helmets

Typical properties

ADF Model
None
Brands
Speedglas™
Case Quantity
1
Compatible Welding Helmet
9100 Series
Features
9100 Series Accessory, Hard Top, Side Windows
For Use With
3M™ Speedglas™ 9100 Welding Helmets
Graphic Theme
Black
Headgear Type
Faceshields
Pr

3M™ Speedglas™ 9100 QR Spacer Bar 06-0119-00QR, 1 EA/Case

3M Product Number 06-0119-00QR 3M ID 7100031975 UPC 00051141563541

Details

Spacer Bar
Replacement Part
For use with 9100 QR

Typical properties

ADF Dark State Shades

None

ADF Shade Range

None

Brands

Speedglas™

Case Quantity

1

Compatible Welding Helmet

9100 QR Welding Helmets

For Use With

3M™ Speedglas™ 9100X Auto-darkening Filter, 3M™ Speedglas™ 9100XX

Welding Helmets

Includes

3M™ Sp

3M™ Speedglas™ 9100 FX-Air Air Diffuser 06-0700-85, 1 EA/Case

3M Product Number 06-0700-85 3M ID 7000128096 UPC 00051131497252

Details

Air Diffuser
Replacement Part

Typical properties

Brands
Speedglas™
Case Quantity
1
Compatible Welding Helmet
9100 FX-Air Welding Helmets
Features
9100 Series Accessory
For Use With
3M™ Speedglas™ 9100FX-Air Welding Helmets
Product Color
Black
Product Series
9100, 9100 FX-Air
Product Type

3M™ Speedglas™ 9100 Welding Helmet Front Panel 06-0300-55-B, Silver, 5 EA/Case

3M Product Number 06-0300-55-B 3M ID 7000128244 UPC 50051131494959

Details

Silver Front Panel
Replacement Part
9100 Series

Typical properties

ADF Model
None
Brands
Speedglas™
Case Quantity
5
Compatible Welding Helmet
9100 Series
Features
9100 Series Accessory, Hard Top, Side Windows
For Use With
3M™ Speedglas™ 9100 Welding Helmets
Graphic Theme
Black
Headgear Type
Faceshields
Pr

3M™ Speedglas™ Battery Holder SL 05-0370-00, 1 EA/Case

3M Product Number 05-0370-00 3M ID 7000126944 UPC 00051131985636

Details

Battery Holder
Replacement Part

Typical properties

Brands

Speedglas™

Case Quantity

1

Compatible Welding Helmet

SL Series

Features

ADF Accessory

Product Series

100, SL

Recommended Application

Assembly, Facility Maintenance, Grinding, Machine Operation, Sanding, Welding

Recommended Industry

Com

3M™ Speedglas™ Battery Holder 04-0380-00, Blue, 2 EA/Case

3M Product Number 04-0380-00 3M ID 7000126764 UPC 50051131930419

Details

Battery Holders
Replacement Part

Typical properties

Brands

Speedglas™

Case Quantity

2

Compatible Welding Helmet

9000 Series

Features

ADF Accessory

Product Series

9000, 9000 FlexView, 9000 Utility

Recommended Application

Assembly, Facility Maintenance, Grinding, Machine Operation, Sanding, Weldin

3M™ Speedglas™ 9100 Battery Holder 06-0400-55-B, 10 EA/Case

3M Product Number 06-0400-55-B 3M ID 7000127157 UPC 50051135894014

Details

Battery Holder
Replacement Part

Typical properties

Brands

Speedglas™

Case Quantity

10

Compatible Welding Helmet

9100 Series

Features

ADF Accessory

For Use With

3M™ Speedglas™ 9100MP Welding Helmets

Product Color

Blue

Product Series

9100, 9100 FX, 9100 FX-Air, 9100 MP, 9100 QR, 9100-Air, L-Ser

3M™ Speedglas™ 9100 Battery Holder 06-0400-55/37190(AAD), 2 EA/Case

3M Product Number 06-0400-55 3M ID 7010385094 UPC 00051131371903

Details

Battery Holder
Replacement Part

Typical properties

Brands
Speedglas™
Case Quantity
2
Compatible Welding Helmet
9100 Series
Features
ADF Accessory
Product Series
9100, 9100 FX, 9100 MP, 9100-Air
Product Type
Battery Holder
Recommended Application
Assembly, Facility Maintenance, Grinding, Machi

3M™ Speedglas™ G5-02 Welding Helmet Shell 08-0300-52, Without Front Cover, Headband and ADF, 1 ea/Case

Part Number 08-0300-52 3M Product Number 08-0300-52 3M ID 7100239735

Details

Welding helmet shell G5-02 without a headband, front cover or welding filter
For maximum safety and comfort, make it a habit to check your equipment regularly

Excludes welding filter, front cover and headband, which can be ordered separately to get a complete helmet

Ensures you get the correct level of comfort and protection

Typical properties

Brands

Speedglas™

Case Quantity

1/Case

Compatible Welding Helmet

G5-02 Welding Helmets

For Use With

G5-02 Welding Helmets

Product Series

G5

Product Type

Welding Helmet Shell

Recommended Application

Welding

Recommended Industry

Construction,

3M™ Speedglas™ Rail 06-0014-00QR, Quick Release, 1 EA/Case

3M Product Number 06-0014-00QR 3M ID 7100031970 UPC 00051141563671

Details

Quick Release

Typical properties

Brands

Speedglas™

Case Quantity

1

Compatible Welding Helmet

9100 QR Welding Helmets

Product Color

Black

Product Series

9100, 9100 QR

Recommended Application

Assembly, Facility Maintenance, Grinding, Machine Operation, Sanding, Welding

Recommen

3M™ Speedglas™ Rail Retention Parts 06-0114-00QR, 1 EA/Case

3M Product Number 06-0114-00QR 3M ID 7100031971 UPC 00051141563688

Details

Rail Retention Part
Replacement Part
9100 QR

Typical properties

Brands
Speedglas™
Case Quantity
1
Compatible Welding Helmet
9100 QR Welding Helmets
Product Color
Black
Product Series
100, 9100
Recommended Application
Assembly, Facility Maintenance, Grinding, Machine Operation, Sanding, Welding
Recommended

3M™ Speedglas™ Welding Helmet Inner Shield 27-0099-63, for 9100MP, 1 EA/Case

3M Product Number 27-0099-63 3M ID 7000128225 UPC 00051141558141

Details

Replacement inner shield for the 3M™ Speedglas™ Welding Helmet 9100 MP
For use with 3M™ Speedglas™ Welding Filters
Replace your welding helmet shell without purchasing a complete new system
Ensures you get the correct level of comfort and protection

Typical properties

Brands
Speedglas™
Case Quantity
1
Compatible Welding Helmet
9100 MP Welding Helmets
Features
Protection Plate
For Use With
3M™ Speedglas™ 9100MP Welding Helmets
Product Color
Black
Product Series
9100, 9100 MP
Recommended Application
Assemb

3M™ Speedglas™ Welding Helmet Outer Shield 27-0099-68, for 9100MP, 1 EA/Case

3M Product Number 27-0099-68 3M ID 7000128226 UPC 00051141558158

Details

Replacement outer shield for the 3M™ Speedglas™ Welding Helmet 9100 MP
For use with 3M™ Speedglas™ Welding Filters
Replace your welding helmet shell without purchasing a complete new system
Ensures you get the correct level of comfort and protection

Typical properties

Brands

Speedglas™

Case Quantity

1

Compatible Welding Helmet

9100 MP Welding Helmets

Features

Protection Plate

For Use With

3M™ Speedglas™ 9100MP Welding Helmets

Product Color

Black

Product Series

9100, 9100 MP

Recommended Application

Assemb

3M™ Speedglas™ 9100 FX Series Welding Helmets

Details

3M™ Speedglas™ Welding Helmet 9100 FX with adjustable head suspension and clear visor
Flip-up function allows workers to switch between clear visor and available Auto-Darkening Lens
3M™ Speedglas™ Auto-Darkening Lenses provide good contrast and high optical quality
Shade 5 side windows allows peripheral vision
Applications include assembly, assembly and mechanical, facility maintenance, grinding, machine operations, metal repair, sanding, and welding

Typical properties

ADF Model
9100X, 9100XXi, None
ADF Viewing Area (Metric)
54 mm x 107 mm, 73 mm x 107 mm
Battery Life
2500 hours, ADF: up to 1800 Hours
Battery Type
ADF: CR2032, CR2032, Solar cell
Case Quantity
1
Comes with Auto-Darkening Filter (ADF)
No, Yes

Dimensions and Classifications

ADF Viewing Area (Imperial)
2.1 in x 4.2 in, 2.8 in x 4.2 in

3M™ Adflo™ Powered Air Purifying Respirator System with 3M™ Speedglas™ 9100-Air Welding Helmet

Details

All the benefits of the 3M™ Speedglas™ Welding Helmet 9100 Air in combination with 3M™ Adflo™ Powered Air Purifying Respirator

Ergonomically designed head suspension

Fits with 3M™ PELTOR™ Welding Earmuff H505B

With its smart, compact design, the award-winning 3M™ Adflo™ Powered Air Purifying Respirator is specially designed to meet your welding needs

With the right type of filter, the 3M™ Adflo™ Powered Air Purifying Respirator effectively protects you against both particles and gases - all in one system

Typical properties

ADF Dark State Shades

None, Variable 5, 8-13

ADF Model

9100XXi, None

ADF Shade Range

None, Variable 5, 8-13

ADF Viewing Area (Metric)

73 mm x 107 mm

ADF Viewing Area (hwx)

2.8x4.2in

Air Source

PAPR

Battery Life

ADF: up to 1800 Hours, PAPR: up

3M™ GoggleGear™ 2890 Series Safety Goggles

Details

Available in several configurations with either non vented or indirect ventilation
3M™ Scotchgard™ Protector Anti-Fog Coating
D3 (droplet and splash) and D4 (dust) rated
Meets the Impact-Rated Protector requirement of the ANSI-ISEA Z87.1-2020 Standard

Typical properties

Anti Fog Lens
Yes
Case Quantity
10
Comfort Features
Adjustable elastic strap, Elastic Strap
Eyewear Range
Premium
Frame Color
Gray
Frame Style
Goggle
Hard Coat Lens
No
Lens Coating
Anti-fog
Lens Color
Clear, Gray
Lens Marking
Z87+
Lens

3M™ DBI-SALA® Pass-Thru Web Concrete Strap Anchor with D-ring 2100148, Polyester, 12 ft

Part Number 2100148 3M Product Number 2100148 3M ID 7012818255

Details

Available in different lengths for jobsite versatility
Do not use anchorage until it is embedded in cured concrete
Compatible with various fall arrest systems
Features high-strength steel hardware
Economical disposable design
Meets the requirements for ANSI Z359.18, OSHA 1910.140 and OSHA 1926.502
Recommended for use in construction and mining industries

Typical properties

Anchor Install Type
Permanent
Attachment Type
Pass-through/Choker
Brands
DBI-SALA®
Case Quantity
1
Connected Safety ID Equipped
No
Install Type
Disposable
Material
Polyester Web
Product Color
Blue
Product Type
Concrete Anchor Strap
Recom

Dimensions and Classifications

Overall Length (Imperial)
144 in

3M™ DBI-SALA® Pass-Thru Web Concrete Strap Anchor with D-ring 2100055, Polyester, 6 ft

Part Number 2100055 3M Product Number 2100055 3M ID 7012818239

Details

Available in different lengths for jobsite versatility
Do not use anchorage until it is embedded in cured concrete
Compatible with various fall arrest systems
Features high-strength steel hardware
Economical disposable design
Meets the requirements for ANSI Z359.18, OSHA 1910.140 and OSHA 1926.502
Recommended for use in construction and mining industries

Typical properties

Anchor Install Type
Permanent
Attachment Type
Pass-through/Choker
Brands
DBI-SALA®
Case Quantity
1
Connected Safety ID Equipped
No
Install Type
Disposable
Material
Polyester Web
Product Color
Blue
Product Type
Concrete Anchor Strap
Recom

Dimensions and Classifications

Overall Length (Imperial)
72 in

3M™ DBI-SALA® D-ring Bolt Anchor For Concrete 2104568, Fits 11/16 in, 18 mm or 3/4 in Hole

Part Number 2104568 3M Product Number 2104568 3M ID 7012818335

Details

- High strength construction
- Compact and lightweight design
- Rugged and corrosion resistant
- Installs into 11/16 in., 18 mm or 3/4 in. concrete hole
- Use vertically in wall or horizontally in ceiling
- Install as temporary or permanent anchor
- Reusable D-ring assembly - extra bolts available separately
- Safe hook-up indicator
- Swiveling D-ring tie-off point

Typical properties

- Anchor Install Type
 - Permanent & Reusable
- Attachment Type
 - Screw
- Brands
 - DBI-SALA®
- Case Quantity
 - 1
- Connected Safety ID Equipped
 - No
- Dimensions
 - 5.70x3.00x4.40in
- Install Type
 - Reusable or Permanent
- Material
 - Zinc Plated Steel
- Product Color
 - Silver

3M™ Unthreaded Anchorage Ring 9501683, Zinc Plated Steel, 13 mm

Part Number 9501683 3M Product Number 9501683 3M ID 7100310347

Details

- High strength construction
- Compact and lightweight design
- Rugged and corrosion resistant
- Installs into 11/16 in., 18 mm or 3/4 in. concrete hole
- Use vertically in wall or horizontally in ceiling
- Install as temporary or permanent anchor
- Reusable D-ring assembly - extra bolts available separately
- Safe hook-up indicator
- Swiveling D-ring tie-off point

Typical properties

- Attachment Type
 - Bolt/Weld
- Brands
 - Lad-Saf™
- Case Quantity
 - 1
- Connected Safety ID Equipped
 - No
- Dimensions
 - 0.00x0.00x100.00mm
- Install Type
 - Permanent
- Product Color
 - Yellow Zinc
- Product Type
 - D-ring Anchor
- Recommended Industry
 - Construction, General

3M™ Speedglas™ 9100 QR Welding Helmet 06-0300-52QR, No Rail, Hard Hat and ADF, 1 EA/Case

3M Product Number 06-0300-52QR 3M ID 7100200560 UPC 00076308943776

Details

9100 QR Helmet Only
No Hard Hat Included
No ADF Included
See resources section below
No Rail Included

Typical properties

ADF Model
None
Brands
Speedglas™
Case Quantity
1
Features
Hard Top
Graphic Theme
Black
Headgear Type
Welding Helmet
Lens Type
No Lens
Product Color
Black
Product Series
9100
Recommended Application
Assembly, Facility Maintenance, Grindi

3M™ Protecta® Cable Tie-Off Adaptor

Details

Portable and reusable

Meets the requirements for ANSI/ASSP Z359.18, 29 CFR OSHA 1910.140 and 29 CFR OSHA 1926.502

Recommended for use in multiple industries including construction, mining, and oil and gas

Compact and lightweight design

High strength steel O-ring hardware

Variable length galvanized cable tie-off adaptor, pass thru type

Durable galvanized steel cable construction

Typical properties

Anchor Install Type

Reusable

Attachment Type

Pass-through/Choker

Case Quantity

1

Connected Safety ID Equipped

No

Install Type

Reusable

Material

Galvanized Steel

Product Color

Silver

Product Type

Cable Tie-off Adapter

Recommended Industry

Dimensions and Classifications

Overall Length (Imperial)

4 ft, 6 ft

3M™ DBI-SALA® Vacuum Anchor with Air Bottle Attachment 2200108

Part Number 2200108 3M Product Number 2200108 3M ID 7100226831

Details

- Compact and lightweight aluminum design is easy to transport, install, and use
- Provides a secure tie-off point on smooth, non-porous surfaces using vacuum technology
- Approved for horizontal lifeline use
- Heavy-duty storage and transport case
- Compatible with external air power sources for added versatility
- Self-contained design includes on-board air bottle. Compatible with external air power options
- Comprehensive backup system features an audio alarm and vacuum-level indicator
- Built-in check valves provide safety during accidental air loss
- Aviation-rated, intrinsically safe electronics
- Meets the requirements for 29 CFR OSHA 1910.140, OSHA 1926.502
- Can provide power for one additional secondary unit

Typical properties

- Anchor Install Type
 - Reusable
- Attachment Type
 - Vacuum
- Brands
 - DBI-SALA®
- Case Quantity
 - 1
- Connected Safety ID Equipped
 - Yes
- Dimensions
 - 22.00x22.00x6.00in
- For Use With
 - Aviation Industry Use
- Install Type
 - Reusable
- Material
 - Aluminum
- Product Series

3M™ Versaflo™ Vortemp™ Muffler Kit V-211 1 EA/Case

3M Product Number V-211 3M ID 7000126276 UPC 00051138661687

Details

Component of 3M™ Vortemp™ Heating Assemblies V-200 and V-200SS, V-300, V-300SS and V-400

Typical properties

Brands

Versaflo™

CFM Capacity per Minute

100 CFM, 50 CFM

Case Quantity

1/pack

Compatible With

3M™ Valve Assembly V-200, 3M™ Valve Assembly V-300, 3M™ Valve Assembly V-400

Pressure Type

High

Product Color

Black

Product Series

Fresh-Air III, Su

3M™ DBI-SALA® D-Ring Plate Anchor 2101634, Raw Steel Plate, Zinc Plated Steel D-Ring

Part Number 2101634 3M Product Number 2101634 3M ID 7100246177

Details

- High strength construction
- Compact and lightweight design
- Rugged and corrosion resistant
- Bolt or weld to structure for fall arrest anchor point
- Compact steel plate
- Pre-drilled holes
- Zinc plated and Stainless Steel D-ring for compatible tie-off point

Typical properties

- Anchor Install Type
 - Permanent
- Attachment Type
 - Bolt/Weld
- Brands
 - DBI-SALA®
- Case Quantity
 - 1
- Connected Safety ID Equipped
 - No
- Dimensions
 - 0.25x2.00x4.50in
- Install Type
 - Permanent
- Material
 - Zinc Plated Steel
- Product Color
 - Silver, Yellow Zinc
- Prod

3M™ Versaflo™ Vortex Muffler Kit V-111 1 EA/Case

3M Product Number V-111 3M ID 7000126273 UPC 00051138661601

Details

Component of 3M™ Vortex Cooling Assemblies V-100 and V-100SS

Typical properties

Brands

Versaflo™

CFM Capacity per Minute

100 CFM, 50 CFM

Case Quantity

1/pack

Compatible With

3M™ Valve Assembly V-100

Pressure Type

High

Product Color

Black

Product Series

Fresh-Air III, Supplied Air, V-Series

Product Type

Muffler

Supplie

3M™ Replacement Clear Chin Protector CP8 82542-00000 10 EA/Case

3M Product Number 82542-00000 3M ID 7000127233 UPC 10078371825420

Details

For use with 3M™ Faceshield W98
Clear polycarbonate chin protector
For use with any 3M™ Headgear

Typical properties

Brands
3M™
Case Quantity
10
For Use With
3M™ Headgear Systems, WP98 Series Visors
High Heat
Yes
Material
Polycarbonate
Product Color
Transparent
Product Type
Chin Protector
Recommended Industry
Automotive, Construction, Food & Beverage Manu

Dimensions and Classifications

Overall Height (Imperial)
3 in
Overall Height (Metric)
7.62 cm
Overall Length (Imperial)
8 in
Overall Length (Metric)
20.32 cm
Overall Width (Imperial)
3 in
Overall Width (Metric)
7.62 cm

3M™ DBI-SALA® D-ring Anchorage Plate 2101636

Part Number 2101636 3M Product Number 2101636 3M ID 7100230111

Details

- High strength construction
- Compact and lightweight design
- Rugged and corrosion resistant
- Bolt or weld to structure for fall arrest anchor point
- Compact steel plate
- Pre-drilled holes
- Zinc plated and Stainless Steel D-ring for compatible tie-off point

Typical properties

- Anchor Install Type
 - Permanent
- Anchor Type
 - D-ring Anchorage Plate
- Attachment Type
 - Bolt/Weld
- Brands
 - DBI-SALA®
- Case Quantity
 - 1
- Connected Safety ID Equipped
 - No
- Dimensions
 - 0.25x2.00x4.50in
- Install Type
 - Permanent
- Material
 - Zinc Plated Steel
- Pro

3M™ SA-Series Supplied Air Regulator Valves & Assemblies

Details

Low maintenance - no filters, cartridges, or batteries to maintain

Typical properties

CFM Capacity per Minute
100 CFM, 50 CFM
Cartridge or Filter Included
No
Case Quantity
1
Fitting Type
Industrial Interchange
Pressure Type
High,Low
Product Color
Black
Product Series
SA-1000
Product Type
Connector, Valve
Recommended Industr

3M™ Versaflo™ Premium Holder V-112, for V-100 and V-200 Series Air Regulating Valves

3M Product Number V-112 3M ID 7100091678 UPC 00051131374157

Details

Enables V-100 and V-200 air regulating valves to be worn in a vertical or horizontal position for comfort of wear

Enables use of TR-325 standard belt, TR-326 high durability belt or TR-327 easy clean belt

Provides thermal padding between valve and wearer

Securely holds valve during use

Typical properties

Brands

Versaflo™

Case Quantity

1/pack

Compatible With

3M™ Valve Assembly V-100, 3M™ Valve Assembly V-200, 3M™ Versaflo™ TR-300 Series Belt, 3M™ Versaflo™ V-100 Cooling Tube

Material

Web

Mounting Type

Belt-mounted

Product Color

Black

Product Se

Dimensions and Classifications

Overall Length (Imperial)

12.1 in

3M™ Protective Coverall 4565

Details

Constructed from non-microporous PE laminate material for Type 4, 5, and 6 protection

Anti-static treatment can help reduce static build-up

Knit cuffs provide a soft wrist closure for increased comfort

Taped seams across the suit offer additional strength and protection

Recommended for use in multiple industries including agriculture, biological and biohazard, cleaning and maintenance, industrial and pharmaceutical manufacturing, painting, and more

20 units included in each case

Typical properties

Closure Method

Two-way Zipper

Features

3 Panel Hood, Anti-static, Biological Protection, Infective Agent, Elastic Waist & Ankle, Knitted Cuff, Radioactive Particulate Protection, Taped Seams

Hazard Type

Dust, Light Liquid splash, Liquid Spray, Partic

3M™ Speedglas™ G5-03 Pro Welding Helmets

Details

Robust, compact design
Ergonomic, adjustable head suspension
GRIND and CUT mode functionality, when using G5 auto darkening filters
Available in two different Auto-Darkening Lens options (VC/TW)
Suitable for most types of arc welding

Typical properties

ADF Model
G5-01/03TW, G5-01/03VC, G5TW, G5VC, None
ADF Technology
Natural Color, TAP, Tack Weld Mode, Variable Color
ADF Viewing Area (Metric)
73 mm x 107 mm, 73 mm x 109 mm
Battery Type
Lithium 3 Volt, Lithium 3V (CR2450)
Brands
Speedglas™
Case

Dimensions and Classifications

ADF Viewing Area (Imperial)
2.8 in x 4.3 in

3M™ Acid Gas Cartridge/Filter 60922, P100 60 EA/Case

3M Product Number 60922 3M ID 7000126165 UPC 50051138464665

Typical properties

Accessories

Yes

Aerosol Type

Oil and Non-Oil

Brands

3M™

Cartridge or Filter Type

Gas & Vapor

Case Quantity

60/case

Clip-on Welding Shield

Yes

Compatible Respirator

3M™ Full Facepieces 6000, 3M™ Full Facepieces 7800 Series, 3M™ Full Facepieces

Dimensions and Classifications

Overall Height (Imperial)

3.4 in

Overall Length (Imperial)

4.2 in

3M™ Formaldehyde Organic Vapor Cartridge/Filter 60925, P100 60 EA/Case

3M Product Number 60925 3M ID 7000126166 UPC 50051138464696

Details

CE approved to protect against a range of gases, vapours and particulates depending on the model selected

Bayonet-style connection fits a wide range of compatible half and full facepiece

3M™ Reusable Respirators

Use with CE approved 3M™ 6000 Series Half Face Masks, 6500QL Series, 7500 Series and 6000 Series Full Face Masks

Swept-back, low profile design for optimised field of view and balance

Typical properties

Accessories

Yes

Aerosol Type

Oil and Non-Oil

Brands

3M™

Cartridge or Filter Type

Combination

Case Quantity

60/case

Clip-on Welding Shield

Yes

Compatible Respirator

3M™ Full Facepieces 6000, 3M™ Full Facepieces 7800 Series, 3M™ Full Facepieces

Dimensions and Classifications

Overall Height (Imperial)

3.4 in

Overall Length (Imperial)

4.2 in

3M™ DBI-SALA® I-Beam Trolley Anchor 2103147, Stainless Steel, Fits 3 - 8 in Wide, 11/16 in Thick

Part Number 2103147 3M Product Number 2103147 3M ID 7100260111

Details

Compatible with various fall protection systems

Compact, lightweight design

Ideal for use with personal fall arrest systems with self-retracting lifelines

Recommended for use in the construction, general industrial, mining, oil and gas, transportation, utilities, and wind energy industries

Portable and reusable

Corrosion-resistant construction for durability

This safety equipment is designed for use with additional personal protective equipment (PPE)

Installs onto 3 in. to 8 in. (7.6 - 20.3 cm.) wide and up to 11/16 in. (1.7 cm.) thick I-beam flange and attaches anywhere on a horizontal beam with complete horizontal mobility and a hands-free design

Fixed rotating D-ring mounts in the center for better weight distribution

Rotating D-ring tie-off point is fixed in center

Typical properties

Anchor Install Type

Reusable

Anchor Type

I-Beam

Attachment Type

Clamp

Brands

DBI-SALA®

Case Quantity

1

Connected Safety ID Equipped

Yes

Dimensions

11.60x8.80x8.40in

Fits Ibeam Flange Width

3 to 8 in. (7.6-20.3cm)

For Use With

3M™ DBI-SALA

3M™ Lens Gasket 7992/7992-AM, 1 EA/Case

3M Product Number 7992/7992-AM 3M ID 7000126526 UPC 00051131528000

Details

Approved 3M™ replacement part
Use with 3M Clip-on Welding Shield Kit 7990/7990-AM (sold separately)
Maintains original performance standards of welding shield
Designed for easy installation on the welding shield
Replaceable part can extend service life of welding shield and potentially result in cost savings

Typical properties

Accessories
Yes
Brands
3M™
Case Quantity
1/pack
Clip-on Welding Shield
Yes
Compatible with 3M™ PAPR Systems
Yes
Compatible with 3M™ Supplied Air System
Yes
Compatible with Welding Shield
No
Cool Flow™ Exhalation Valve
No
Drop-down Feature

3M™ Inhalation Port Gasket 7887, Replacement Part 20 EA/Case

3M Product Number 7887 3M ID 7000125979 UPC 50021200603285

Details

Approved 3M replacement part

Designed for use in the two side DIN ports of 3M Full Facepieces 7800S (sold separately)

Gasket helps prevent leakage through bottom of DIN ports

Replacement part can extend service life of facepiece

Replaceable part can potentially result in respiratory equipment cost savings

Typical properties

Accessories

Yes

Brands

3M™

Case Quantity

2/pack

Clip-on Welding Shield

Yes

Compatible with 3M™ PAPR Systems

Yes

Compatible with 3M™ Supplied Air System

Yes

Compatible with Welding Shield

No

Cool Flow™ Exhalation Valve

No

Drop-down Feature

3M™ Air Inlet Gasket 7999, Replacement Part 10 EA/Case

3M Product Number 7999 3M ID 7000051843 UPC 50021200603834

Details

Approved 3M replacement part
Designed for use in center inlet port 3M Full Facepiece 7800 Series (sold separately)
Air inlet gasket can extend service life of facepiece
Use can potentially result in respiratory equipment cost savings
Gasket maintains original service performance of facepiece

Typical properties

Accessories
No
Boxes per Case
10
Brands
3M™
Case Quantity
10/case
Clip-on Welding Shield
No
Compatible with 3M™ PAPR Systems
No
Compatible with 3M™ Supplied Air System
No
Compatible with Welding Shield
No
Cool Flow™ Exhalation Valve
No
D

3M™ DBI-SALA® Confined Space Pole Hoist System 8530252

3M Product Number 8530252 3M ID 7100188845 UPC 00840779009176

Details

Available in extensions of 4 ft.–7 ft. (1.2 m–2.1 m) or 6 ft.–10 ft. (1.8 m–3 m)
Built in pulley for 3-way SRL with emergency retrieval or winch
Swivel head rotates 360 degrees
The 3-way SRL with emergency retrieval or winch attach easily to mounting bracket
T-bar for added stability
Durable construction
Set up and dismantle without tools

Typical properties

Brands
DBI-SALA®
Case Quantity
1
Connected Safety ID Equipped
No
For Entry Type
Horizontal & Vertical
Install Type
Portable
Material
Aluminum
Maximum Arm Length (Imperial)
10 ft
Maximum Arm Length (Metric)
3 m
Maximum Pole Length (Imperial)

Dimensions and Classifications

Overall Height (Imperial)
47.67 in
Overall Height (Metric)
121.08 cm

3M™ DBI-SALA® Confined Space Portable Extendable Pole Hoist T-Bar Leg Assembly 8561235, Stainless Steel Hardware

3M Product Number 8561235 3M ID 7100311857

Details

Available in extensions of 4 ft.–7 ft. (1.2 m–2.1 m) or 6 ft.–10 ft. (1.8 m–3 m)

Built in pulley for 3-way SRL with emergency retrieval or winch

Swivel head rotates 360 degrees

The 3-way SRL with emergency retrieval or winch attach easily to mounting bracket

T-bar for added stability

Durable construction

Set up and dismantle without tools

Typical properties

Brands

DBI-SALA®

Case Quantity

1

Connected Safety ID Equipped

No

For Entry Type

Horizontal & Vertical

Install Type

Portable

Material

Aluminum

Maximum Pole Length (Imperial)

4.5 ft

Maximum Pole Length (Metric)

1.4 m

Minimum Pole Length (Imp

3M™ DBI-SALA® Clamp-On Anchor With Vertical/Horizontal Flange Up To 6" Thick 1 EA/Case

3M Product Number 8520777 3M ID 7100204058

Details

Available in extensions of 4 ft.–7 ft. (1.2 m–2.1 m) or 6 ft.–10 ft. (1.8 m–3 m)

Built in pulley for 3-way SRL with emergency retrieval or winch

Swivel head rotates 360 degrees

The 3-way SRL with emergency retrieval or winch attach easily to mounting bracket

T-bar for added stability

Durable construction

Set up and dismantle without tools

Typical properties

Brands

DBI-SALA®

Material

Aluminum

Mount Type

Flange Face

SRL Included

No

3M™ DBI-SALA® Confined Space Pole Hoist System 8530253

3M Product Number 8530253 3M ID 7100188846

Details

Available in extensions of 4 ft.–7 ft. (1.2 m–2.1 m) or 6 ft.–10 ft. (1.8 m–3 m)
Built in pulley for 3-way SRL with emergency retrieval or winch
Swivel head rotates 360 degrees
The 3-way SRL with emergency retrieval or winch attach easily to mounting bracket
T-bar for added stability
Durable construction
Set up and dismantle without tools

Typical properties

Brands
DBI-SALA®
Case Quantity
1
Connected Safety ID Equipped
No
For Entry Type
Horizontal & Vertical
Install Type
Portable
Material
Aluminum
Maximum Arm Length (Imperial)
10 ft
Maximum Arm Length (Metric)
3 m
Maximum Pole Length (Imperial)

Dimensions and Classifications

Overall Height (Imperial)
47.67 in
Overall Height (Metric)
121.08 cm

3M™ DBI-SALA® Confined Space Portable Extendable Pole Hoist 8560476, Stainless Steel Hardware, 6 ft - 10 ft

3M Product Number 8560476 3M ID 7100311856

Details

Available in extensions of 4 ft.–7 ft. (1.2 m–2.1 m) or 6 ft.–10 ft. (1.8 m–3 m)

Built in pulley for 3-way SRL with emergency retrieval or winch

Swivel head rotates 360 degrees

The 3-way SRL with emergency retrieval or winch attach easily to mounting bracket

T-bar for added stability

Durable construction

Set up and dismantle without tools

Typical properties

Brands

DBI-SALA®

Case Quantity

1

Connected Safety ID Equipped

No

For Entry Type

Horizontal & Vertical

Install Type

Portable

Material

Aluminum

Maximum Arm Length (Imperial)

10 ft

Maximum Arm Length (Metric)

3 m

Minimum Arm Length (Imperial)

FUTURO™ Dress Socks for Men, Firm Compression

3M ID CBGBLW011019 UPC 00051131215771

Details

Firm Compression (20-30 mm/Hg)

Use for tired or achy legs, swelling, mild spider and varicose veins

Ideal for standing or sitting all day, traveling or active office work

Graduated compression helps improve circulation

Great for business casual or weekend wear

Comfort band ensures socks stay in place

Durable, reinforced toe and heel provide lasting wear

Made from a comfortable blend of nylon and spandex

Size: M, L, XL

Color: Black

Typical properties

Body Part

Leg

Brands

FUTURO™

Factory ISO Certification

No ISO Certification information available

Material

Nylon, Spandex

Product Color

Black

Product Type

Socks

Product Usage

Being on Feet All Day, Chronic Leg Conditions, DVT, Swelling, Trave

3M™ 2091 Performance Filter P100 for 3M™ Reusable Respirators

3M ID CBGNAW011096 UPC 00051131070004

Details

NIOSH-APPROVED P100 filters at least 99.97% filtration efficiency against solids and liquid aerosols as well as oils

FOR WORKPLACE/OCCUPATIONAL USE ONLY

OIL PROOF (Use according to manufacturer's time use restrictions when oil aerosols are present)

INTENDED FOR the professional removal of mold, lead-based paints, woodworking and working with fiberglass insulation

APPROVED FOR USE WITH 3M™ 6000, 6500 AND 7500 SERIES FACEPIECES

EASY-TO-ATTACH DESIGN

Replace your filter when it's dirty, damaged or difficult to breathe through

Facepiece is not included

Use this product is in accordance with all applicable respiratory protection requirements including OSHA Lead Standard and US-EPA Guidelines for mold

Filter Color: Magenta

Package contents:

WARNING: Workplace/Occupational Applications: This respirator helps protect against certain airborne contaminants. Misuse may result in sickness or death.

For correct use, consult supervisor and User Instructions, or call 3M in USA at 1-800-243-4630. In Canada, call 1-800-267-4414

Typical properties

Application

Mold Remediation, Sanding and scraping lead-based paint

Cartridge or Filter Included

Yes

Cartridge or Filter Type

Particulate

Clip-on Welding Shield

No

Compatible with 3M™ PAPR Systems

No

Compatible with 3M™ Supplied Air System

No

Dimensions and Classifications

Overall Height (Imperial)

2 in

Overall Height (Metric)

5.08 cm

Overall Length (Imperial)

7 in

Overall Length (Metric)

17.78 cm
Overall Width (Imperial)
6 in
Overall Width (Metric)
15.24 cm

3M™ Non-vented Hard Hat with Pinlock Adjustment, Yellow 91296-80025T
12/case

3M ID 70005087765 UPC 10078371612303

Details

Yellow

Pinlock allows easy size adjustment

Four-point, fully adjustable nylon suspension

Large, pillow-padded sweatband for extra comfort

Dielectric will not conduct electrical current

Meets the requirements of ANSI Z89.1-2003, Type 1, Class G and E

Meets the requirements of CSA Z94.1-2005, Type 1, Class G and E

Typical properties

Brands

3M™

Factory ISO Certification

No ISO Certification information available

eClass 14 Classification Group

40300202

3M™ Replacement Cartridges for Household Multi-purpose Respirator 60921HB1-A, 1 pr/pk, 5 packs/cs

3M ID 70005079929 UPC 00051141900230

Details

NIOSH-APPROVED OV CARTRIDGE WITH P100 FILTER filters at least 99.97% of solids and liquid aerosols as well as certain organic vapors

Filter is OIL PROOF (Use according to manufacturer's time use restrictions when oil aerosols are present)

EASY-TO-ATTACH DESIGN

USE FOR ODOR REDUCTION and with certain non-harmful sprays/vapors from latex and oil-based paints, stains, varnishes, coatings and sealants

ALSO HELPS PROTECT against certain pesticides*. *Refer to Pesticide Product Label for Respirator Guidance or call 3M at 1-800-243-4630 or In Canada, call 1-800-267-4414

APPROVED FOR use with 3M™ 6000, 6500 and 7500 series facepieces

For help in determining when to change your cartridge visit 3M.com/ServiceLife

Facepiece is not included

Cartridge Color: magenta and black

Package Contents:

DIY/Home Use: Use ONLY in NON-HARMFUL environments

Occupational/Hazardous Use: Use under a government regulated (e.g. OSHA) respiratory protection program

WARNING: Limitations apply; Misuse may result in sickness or death. See product packaging and insert or call 3M in USA at 1-800-243-4630. In Canada, call 1-800-267-4414

Typical properties

Application

Applying pesticides, Coatings and sealants, Spraying certain non-harmful sprays, Varnishes

Brands

3M™

Factory ISO Certification

No ISO Certification information available

NIOSH Filter Approval Rating

OV/P100

Product Type

Speciality Ki

3M™ ANSI Class 2 Two-Tone Safety Vest, Yellow

3M ID CBGNAWUS2197 UPC 00051141376646

Details

3M™ Scotchlite™ Reflective Material offers high visibility when illuminated by a light source
360 degrees of reflectivity offers exceptional visibility on the job
Lightweight design for a comfortable fit
Neon fabric offers great visibility during the daytime
For occupational workers who are exposed to roadway traffic and who work in an environment with moving equipment/vehicles
Designed for moderate-risk activities like construction, utility, school crossing and traffic direction
3M™ Safety Vest is machine washable
Intended for professional use
Compatible with many types of additional PPE
Class 2 vest meets the requirements of ANSI/ISEA 107-2010
Complies with the Federal Highway Mandate (2009) Manual of Uniform and Traffic Control Devices
One size fits most
Color: Yellow
Package Contents: 1 Vest

Typical properties

ANSI Class Level
Class 2
Factory ISO Certification
No ISO Certification information available
Flame Resistance (ASTM D2859-96)
No
Garment Hood
No
Garment Lined
No
Garment Reversible
No
Material
Polyester
Product Type
High Visibility
Size

Dimensions and Classifications

Overall Height (Imperial)
8.2 in
Overall Height (Metric)
20.8 cm

Overall Length (Imperial)

7.4 in

Overall Length (Metric)

18.8 cm

Overall Width (Imperial)

1 in

Overall Width (Metric)

2.54 cm

Peltor™ Sport Bull's Eye™ Hearing Protector, 97041-PEL-6C, 27 NRR Black/Gray

3M ID 70006956695 UPC 00051125005654

Details

Mid-range NRR with low to moderate profile
Lightweight and comfortable for extended wear
Fully adjustable headband ergonomically engineered to reduce pressure points
Open frame reduces heat buildup and improves comfort when worn with hats/caps
Soft, conformable rings provide a better seal
Stylish, two-color design

Typical properties

Brands
PELTOR™
Catalog Number
97041-PEL-6C
Factory ISO Certification
No ISO Certification information available
Product Type
Earmuff
Project Applications
DIY and Professional, Installing Flooring and Trim, Laying tile, Refinishing Floors,
Refinis

3M™ Pro-Grade Earmuff 90565-4DC-PS, 4 each/case

3M ID 70006963535 UPC 00076308873356

Details

Our #1 noise-reducing earmuff (highest noise reduction rating (NRR) 3M™ Earmuff in retail stores)

Noise Reduction Rating (NRR) of 30 dB*

Helps protect against harmful noises that are at 85 dB and above

Steel wire headband with rubber overmold design for durability and comfort

Lightweight, adjustable design reduces pressure points for all-day comfort

Premium cushioning and pivoting cups to help ensure a good fit

Flexible headband adjusts to multiple head sizes

Vented headband design improves comfort when worn with hats (see insert regarding proper fit)

Helps lower your risk of noise-induced hearing loss

Great for use in noisy workshops, factories, construction sites and during landscaping

Package Contents: 1/Pack

Typical properties

Bluetooth

No

Brands

3M™

Built In FM and or AM Radio

No

Built in 2-Way Radio

No

Catalog Number

90565-4DC-PS

Communication via External 2-Way Radio

No

Earmuff Style

Over the Head

External Audio Input

No

Factory ISO Certification

No ISO Cert

Dimensions and Classifications

Overall Height (Imperial)

7 in

Overall Height (Metric)

17.78 cm

Overall Length (Imperial)

3.9 in

Overall Length (Metric)

9.906 cm

Overall Width (Imperial)

5.4 in

Overall Width (Metric)

13.716 cm

FUTURO™ Performance Compression Arm Sleeve

3M ID CBGBLRUS1488 UPC 00051131204935

Details

Provides all over, even compression to areas covered by the sleeve
Four-way stretch fabric and ergonomic construction enable a wide range of motion
Low-profile, breathable fabric helps keep air flowing
Great for everyday use and during athletic activities
Simply hand wash with mild soap and air dry
Supported by our expert panel of engineers and medical professionals
Includes one compression sleeve
Size: S/M, L/XL

Typical properties

Body Part
Arm
Brands
FUTURO™
Factory ISO Certification
No ISO Certification information available
Injury
General Soreness, Swelling
Product Color
Gray
Product Type
Sleeve
Product Usage
Fitness Activity
Product Use
Brace & Support
Size
Lar

3M™ Mold Remediation Respirator Kit 69097, Large 2 Kits EA/Case

3M Product Number 68097 3M ID 7010316002 UPC 50051131527930

Details

Full facepiece respirator assembly
Includes P100, nuisance organic vapor particulate filters
Large lens for wide field of view
Lightweight, balanced design
Silicone face seal for greater comfort and durability

Typical properties

Accessories
No
Brands
3M™
Case Quantity
2
Clip-on Welding Shield
No
Compatible with 3M™ PAPR Systems
No
Compatible with 3M™ Supplied Air System
No
Compatible with Welding Shield
No
Connection Type
Bayonet
Cool Flow™ Exhalation Valve
No
D

3M™ Mold Remediation Respirator Kit 68097, Medium 2 Kits EA/Case

3M Product Number 68097 3M ID 7000144916 UPC 50051131527923

Details

Full facepiece respirator assembly
Includes P100, nuisance organic vapor particulate filters
Large lens for wide field of view
Lightweight, balanced design
Silicone face seal for greater comfort and durability

Typical properties

Accessories
No
Brands
3M™
Case Quantity
2
Clip-on Welding Shield
No
Compatible with 3M™ PAPR Systems
No
Compatible with 3M™ Supplied Air System
No
Compatible with Welding Shield
No
Connection Type
Bayonet
Cool Flow™ Exhalation Valve
No
D

3M™ DBI-SALA® Permanent Roof Top Anchor For Single Ply Bitumen Membrane/Built-Up 2100142, with Weather Proof Shroud

Part Number 2100142 3M Product Number 2100142 3M ID 7100314285

Details

Durable materials and hardware designed to help stand up to harsh working conditions
Compatible with various fall arrest systems, not compliant for use with Horizontal Lifelines
Suitable for use in general industrial and construction industries
Compact, lightweight design
Meets the requirements for 29 CFR OSHA 1910.140 and 29 CFR OSHA 1926.502
Features corrosion-resistant, steel and aluminum construction for durability
This safety equipment is designed for use with additional personal protective equipment (PPE)
Installs to single ply bitumen membrane and built-up type roofs. Complete with shroud for bitumen offering maximum weather proofing
Multi-person use with horizontal lifeline system. Load distributing design protects roof and user
Can be used with multiple fastener options
Fastens through membrane, insulation and into metal, wood or concrete with aesthetic design to compliment the roof

Typical properties

Anchor Install Type
Permanent
Anchor Type
Roofing
Attachment Type
Toggle Bolt
Brands
DBI-SALA®
Case Quantity
1
Connected Safety ID Equipped
No
Dimensions
16.00x16.00x9.00in
For Use With
Bitumin Roofs
Install Type
Permanent
Material
Zinc

3M™ DBI-SALA® Rollgliss™ R550 Edge Protector 3320046

3M Product Number 3320046 3M ID 7012818868 UPC 03660570058336

Details

Rollgliss™ R550 Rescue Edge Protector used to protect rope from sharp edges

Typical properties

Brands
DBI-SALA®
Descent Type
None
For Use With
Rescue & Descent Devices
Maximum Number of Users
Two
Net Weight (Imperial)
0.82 lb
Net Weight (Metric)
0.37 kg
Product Color
Orange
Product Series
Rollgliss™ R550
Product Type
Edge Protector

Dimensions and Classifications

Overall Length (Imperial)
0.416 ft
Overall Length (Metric)
0.127 m

3M™ Breathe Easy™ Battery Adapter Upgrade Kit RBE-600, 1 EA/Case

3M Product Number RBE-600 3M ID 7100144938 UPC 00051131275386

Details

Easy to use

Easy to clean

Works with 3M™ Standard Battery TR-630 providing longer run time than the 3M™ Breathe Easy™ Turbo Powered Air Purifying Respirator (PAPR) NiMH Battery Pack BP-15

Comfortable

Replaces BP-15 Battery

Typical properties

Battery Life

5.5 to 13 hours

Battery Type

High Capacity Lithium Ion - Rechargeable

Brands

Breathe Easy™

Breathing Tube Type

Back-Mounted

Case Quantity

1/case

Compatible With

3M™ Versaflo™ TR-600 Series Battery

Includes

battery adapter (TR-659)

3M™ Versaflo™ Battery Adapter TR-659, 1 EA/Case

3M Product Number TR-659 3M ID 7100127544 UPC 00051131275362

Details

Easy to use

Replaces BP-15 battery for certain GVP and Breathe Easy RBE & FR Systems

Works with 3M™ Standard Battery TR-630

Typical properties

Battery Life

9 Hours

Battery Type

High Capacity Lithium Ion - Rechargeable

Brands

Versaflo™

Case Quantity

1/case

Compatible Respirator Type

PAPR

Compatible With

3M™ Breathe Easy™ PAPR, 3M™ GVP-Series PAPR

Enhanced Comfort

Yes

Intrinsically S

3M™ Versaflo™ Premium Visor M-927/37324(AAD), 5 EA/Case

3M Product Number M-927 3M ID 7000052876 UPC 00051131373242

Details

Scratch and chemical resistant
For use on all M-Series helmets

Typical properties

Brands
Versaflo™
Case Quantity
5
Compatible With
3M™ Versaflo™ M-Series Helmet
Headgear Type
Headcover
High Heat
No
Material
Polycarbonate
Product Color
Transparent
Product Series
M-Series
Product Type
Faceshield
Recommended Application

3M™ Adflo™ High Efficiency Starter Kit 15-1101-99/37147(AAD), 1 EA/Case

3M Product Number 15-1101-99 3M ID 7000126735 UPC 00051131371477

Details

Starter Kit
Replacement Part

Typical properties

Brands

Adflo™

Cartridge or Filter Included

Pre-filter, HE Filter

Case Quantity

1

Features

Respiratory Accessory

NIOSH Cartridge or Filter Assigned Color Coding

Magenta

Product Series

Adflo

Recommended Application

Assembly, Facility Maintenanc

3M™ Versaflo™ Cleaning & Storage Kit TR-653/37373(AAD), for TR-600/800 PAPR, 1 EA/Case

Part Number 37373 3M Product Number TR-653 3M ID 7100035841

Details

- Enables TR-600 PAPR to be rinsed under running water
- Enables TR-600 to be submerged for cleaning
- Helps protect TR-600 from internal contamination during cleaning
- Helps protect TR-600 from internal contamination during storage

Typical properties

- Brands
Versaflo™
- Case Quantity
1/pack
- Compatible With
3M™ Versaflo™ TR-600 Series PAPR, 3M™ Versaflo™ TR-800 Series PAPR
- Hazard Type
Silica
- Product Series
TR-600
- Product Type
Cleaning & Storage Kit
- Recommended Application
Composite Finishing,

3M™ Versaflo™ Visor Attachment Clips (Left and Right) for Premium Head Suspension, S-952 1 Pair/Case

3M Product Number S-952 3M ID 7100077600 UPC 00051131373044

Details

Replacement part for S-950 Premium Head Suspension
Each box contains one left clip and one right clip

Typical properties

Brands
Versaflo™
Compatible With
3M™ Adflo™ PAPR
Headgear Type
Hood
Product Color
Gray
Product Series
S-Series, Versaflo
Product Type
Attachment Clip
Recommended Application
General Maintenance, Material Handling
Recommended Industry
Marine

3M™ Scott™ EPIC 3 RI Voice Communication System

3M ID B5005046023

Details

Operates with a broad range of field radios to provide clear communication when and where you need it

Works with compatible 3M Scott SCBA and other respiratory equipment

User friendly set-up and operation helps to minimize training

Durable, high-heat rated construction to withstand the rigors of the fireground

Same operational and performance benefits of the EPIC 3 Voice Amplifier

NFPA- and NIOSH-compliant as an accessory to compatible Air-Pak SCBA models

Compatible with Scott SCBA and facepieces for increased long-term value

Add enhanced communications to new and legacy Scott Safety SCBA and PPE, providing additional safety benefits and value

Easy-to-use utilities make programming virtually effortless

All EPIC 3 Voice Amplifiers and Lapel Speaker Microphones can be easily software configured to meet specific customer use case and radio interoperability requirements if required. Device firmware and features can be upgraded while in the field, extending device utility while reducing device administration costs

Durable high-heat rated construction withstands the rigors of firefighting

All EPIC 3 Voice Amplifiers and Lapel Speaker Microphone housings and cables are purpose built to withstand the demands and high temperatures (up to 500° F) associated with interior firefighting, ensuring years of reliable operation and low maintenance costs

Typical properties

Brands

Scott™

Product Type

Respiratory Communication System

3M™ Scott™ Ska-Pak Plus Supplied-Air Respirator

3M ID B5005047151

Details

Combination Type C positive pressure respirator with escape cylinder for entry into or escape from hazardous, confined space, or immediately dangerous to life or health (IDLH) situations

Available with either a padded Kevlar® harness, a padded nylon harness or integrated full-body harness for fall protection

E-Z Klip cylinder retention system for quick and easy cylinder changes

Available in 2216, 3000 and 4500 psi and 5, 10 or 15 minute rated-cylinder egress options for versatility based on job at hand

The E-Z Flo regulator is designed for easy use with gloved hands, enables easy breathing, and has a two-step secure attachment and removal to help ensure worker confidence

NIOSH approved for use with 3M Scott AV series facepieces that can also be used for APR, PAPR, supplied air, and SCBA applications

Padded Nylon that is designed to be comfortable and lightweight

Padded fire-resistant Kevlar® for high heat environments or when there is potential for sparking

Integrated full-body harness combines 3M's Fall Protection technology with the 3M™ Scott™ Ska-Pak Supplied-Air Respirator. This integrated solution is a NIOSH-approved respirator and suitable for confined spaces and working at height applications, providing workers with fall and respiratory protection in hazardous conditions

Typical properties

Brands

Scott™

Compatible Facepiece

AV-3000 SureSeal

Connection Type

Compressed Air Line

Gauge Type

Mechanical

In-line Air Filter Included

No

Product Type

Supplied Air Respirator

Specifications Met

NIOSH 42 CFR

3M™ Scott™ RIT-Pak Fast Attack Emergency Air Supply System

3M ID B5005047168

Details

- Small, lightweight, and compact
- Available in 4.5 or 5.5 cylinder pressures
- Available in two bag sizes: small and medium
- Compatible with 15-min and 30-min cylinders
- Compatible with Air-Pak SCBA equipped with Universal EBSS
- Hi-Viz orange with 3M™ Scotchlite™ Reflective Material
- Tactile feel pull handles for easy identification
- External pressure gauge with photoluminescent display
- Distinct, audible low-pressure whistle alarm
- Low-pressure hose and EBSS manifold with auxiliary ports
- Color-coded storage pouches for easy identification
- Carabiners w/captive bar: never lose the carabiner
- Easy-to-remove, adjustable length shoulder strap
- The facepiece, a modified AV-3000 with SureSeal, has a simple-to-use donning handle, making it quick and easy to strap onto a downed firefighter or victim

Typical properties

- Airline Connector Brand
- Hansen
- Brands
- Scott™
- Included Regulator
- E-Z Flo
- Product Type
- Self-contained Breathing Apparatus

3M™ PELTOR™ Electronic Earplug, EEP-100

3M Product Number EEP-100 3M ID 7100193144 UPC 00051131277434

Details

Helps provide hearing protection in environments with hazardous noise
External microphones help you hear communication and environmental sounds
Designed by 3M PELTOR and built tough for the working professional
Intuitive one-button operation powers earpiece on/off and selects volume level
Rechargeable lithium-ion battery, charging cable included
Weather-resistant earpieces and charging case (IP54)
Small and lightweight design
Compatible with most headborne Personal Protective Equipment such as helmets, hardhats, eyewear and faceshields
Choice of replaceable communications eartips designed to fit most ear canal sizes: UltraFit™ Communication Tip (23dB), Triple C Communication Tip (27dB), and Skull Screw Communication Tip (30dB)
3M strongly recommends individual fit testing of hearing protectors. If the NRR is used to estimate typical workplace protection, 3M recommends that the noise reduction value be reduced by 50% or in accordance with applicable regulations

Typical properties

Battery Life
16 hr
Battery Type
Lithium-ion Rechargeable
Bluetooth
No
Brands
PELTOR™
Built In FM and or AM Radio
No
Built in 2-Way Radio
No
Communication Type
Ambient Listening
Communication via External 2-Way Radio
No
External Audio Input

3M™ PELTOR™ Level Dependent Earplug, LEP-200

3M Product Number LEP-200 3M ID 7010316631 UPC 00093045938254

Details

Allow audio signals to be received wirelessly from a neckloop accessory

Helps provide hearing protection

Environmental Microphones for Level-dependent hearing protection and situational awareness

The ear pieces are rechargeable via Micro USB or 3-AA Alkaline Batteries

Typical properties

Auxiliary Port

Micro USB Charging Port

Battery Type

Lithium-Ion

Bluetooth

No

Brands

PELTOR™

Built In FM and or AM Radio

No

Built in 2-Way Radio

No

Communication Type

Environmental Listening, Listen Only, Two-way Radio

Communication via Exter

3M™ Over-the-Glass Eyewear, 47110H1-C, Clear, Clear Lens, Anti-Scratch, 10/case

3M ID 70006985348 UPC 00076308729943

Details

Durable Lens Helps Provide Limited Protection From Light To Moderate Impact Hazards

Accommodates Most Personal Eyewear

Lightweight, Durable Design

Scratch-Resistant Coating Helps Keep Vision Clear

Impact-Resistant Lens Blocks 99.9% Of Uv Rays

Excellent Protection Option For Those Who Wear Prescription Eyewear

Great For Use Indoors And Outdoors

Easy-Care Design Cleans With Soap And Water Or A Soft Cloth

Meets The Requirements Of Ansi Z87.1 (Model #47110 Only: Also Meets Csa Z94.3)

Clear Lens Provides Excellent Visibility

Typical properties

Brands

3M™

Catalog Number

47110H1-C

Diopter

0

Factory ISO Certification

No ISO Certification information available

Frame Material

Polycarbonate

Gasket Included

No

Seal Type

No Seal

Temple Color

Clear

Temple Style

Accented

eClass 14 Class

3M™ Over-the-Glass Eyewear, Clear Frame, Clear Lens, 1 Eyewear/Pack

3M ID 70006987823 UPC 00638060080788

Details

Durable Lens Helps Provide Limited Protection From Light To Moderate Impact Hazards

Accommodates Most Personal Eyewear

Lightweight, Durable Design

Scratch-Resistant Coating Helps Keep Vision Clear

Impact-Resistant Lens Blocks 99.9% Of Uv Rays

Excellent Protection Option For Those Who Wear Prescription Eyewear

Great For Use Indoors And Outdoors

Easy-Care Design Cleans With Soap And Water Or A Soft Cloth

Meets The Requirements Of Ansi Z87.1 (Model #47110 Only: Also Meets Csa Z94.3)

Clear Lens Provides Excellent Visibility

Typical properties

Brands

3M™

Catalog Number

47110G1-DC

Factory ISO Certification

No ISO Certification information available

Frame Material

Polycarbonate

eClass 14 Classification Group

40230101

3M™ Eyeglass Protectors Anti-Scratch, 47032H1-DC, Gray, Gray Lens, 6/case

3M ID 70006987948 UPC 00051141981178

Details

Durable lens helps provide limited protection from light to moderate impact hazards

Accommodates most personal eyewear

Lightweight, durable design

Scratch resistant coating helps keep vision clear

Impact resistant lens blocks 99.9% of UV rays

Excellent protection option for those who wear prescription eyewear

Great for use indoors and outdoors

Easy care design cleans with soap and water or a soft cloth

Meets the requirements of ANSI Z87.1

Gray lens helps reduce sunlight and is popular for outdoor use

Typical properties

Brands

3M™

Catalog Number

47032H1-DC

Factory ISO Certification

No ISO Certification information available

Frame Material

Polycarbonate

Material

Polycarbonate

eClass 14 Classification Group

40230101

3M™ Over-the-Glass Safety Eyewear, Clear, Clear Len

3M ID 70006982733 UPC 00076308729943

Details

Durable Lens Helps Provide Limited Protection From Light To Moderate Impact Hazards
Accommodates Most Personal Eyewear
Lightweight, Durable Design
Scratch-Resistant Coating Helps Keep Vision Clear
Impact-Resistant Lens Blocks 99.9% Of Uv Rays
Excellent Protection Option For Those Who Wear Prescription Eyewear
Great For Use Indoors And Outdoors
Easy-Care Design Cleans With Soap And Water Or A Soft Cloth
Meets The Requirements Of Ansi Z87.1 (Model #47110 Only: Also Meets Csa Z94.3)
Clear Lens Provides Excellent Visibility
Lens Color: Clear

Typical properties

Anti Fog Lens
No
Brands
3M™
Catalog Number
47110H1-DC
Factory ISO Certification
No ISO Certification information available
Frame Material
Polycarbonate
Frame Style
Wraparound
Hard Coat Lens
No
Material
Polycarbonate
Sealed Eyewear
No
Spl

Dimensions and Classifications

Overall Height (Imperial)
2.5 in
Overall Height (Metric)
63.5 mm
Overall Length (Imperial)
6.25 in
Overall Length (Metric)
158.75 mm

Overall Width (Imperial)

4 in

Overall Width (Metric)

101.6 mm

3M™ Eyeglass Protectors Safety Eyewear, Clear, Clear Lens

3M ID 70006987930 UPC 00051141981185

Details

Durable lenses help provide limited protection from light to moderate impact hazards

Contoured design

Lightweight – weighs less than 1 ounce

Scratch-resistant coating helps keep vision clear

Meets the requirements of ANSI Z87.1

Clear lenses help provide excellent visibility and can be used indoors or outdoors

Color: Clear

Quantity: 1

Typical properties

Brands

3M™

Catalog Number

47031H1-DC

Factory ISO Certification

No ISO Certification information available

eClass 14 Classification Group

40230101

3M™ Indoor Safety Eyewear, Clear Frame, Clear Lenses, 1/Pack

3M ID 70006947397 UPC 00078371908379

Details

Weighs less than 1 oz
Designed with polycarbonate lenses, the strongest, most impact-resistant eyewear lens material available
Impact-resistant lenses provide 99.9% UV protection
Meets the requirements of ANSI Z87.1-2003
For indoor or outdoor use

Typical properties

Anti Fog Lens
Yes
Brands
3M™
Catalog Number
90953-BU10-NA
Factory ISO Certification
No ISO Certification information available
Frame Material
Polycarbonate
Frame Style
Wraparound
Hard Coat Lens
No
Product Type
Safety Glasses
Sealed Eyewear

Dimensions and Classifications

Overall Height (Imperial)
6 in
Overall Height (Metric)
152.4 mm
Overall Length (Imperial)
2.5 in
Overall Length (Metric)
63.5 mm
Overall Width (Imperial)
8 in
Overall Width (Metric)
203.2 mm

3M™ Safety Eyewear, Clear Frame, Clear lens

3M ID 70006987963 UPC 00051141332185

Details

Durable lenses help provide limited protection from light to moderate impact hazards
Contoured design
Lightweight – weighs less than 1 ounce
Scratch-resistant coating helps keep vision clear
Impact-resistant lenses block 99.9% of UV rays
Meets the requirements of ANSI Z87.1
Clear lenses help provide excellent visibility and can be used indoors or outdoors
Lens Color: Clear
Quantity: 1

Typical properties

Brands
SecureFit™
Catalog Number
90953H1-DC-20
Factory ISO Certification
No ISO Certification information available
Frame Material
Polycarbonate
Frame Style
Wraparound
Hard Coat Lens
No
Material
Polycarbonate
Product Type
Protective Eyewear

Dimensions and Classifications

Overall Height (Imperial)
4 in
Overall Height (Metric)
101.6 mm
Overall Length (Imperial)
2.375 in
Overall Length (Metric)
60.33 mm
Overall Width (Imperial)
8.5 in
Overall Width (Metric)
215.9 mm

3M™ Versaflo™ M-Series Helmet Cover M-978, 1 EA/Case

3M Product Number M-978 3M ID 7100168652 UPC 00076308942793

Details

Compatible with M-400 helmets
Available as replacement part
Designed to provide additional protection to both the wearer and the safety helmet
Optional shroud for use with Versaflo™ M-407SG helmets featuring L-153SG Speedglas™ attachment

Typical properties

Brands
Versaflo™
For Use With
3M™ Versaflo™ Respiratory M-400 Series Helmet Assembly
Headgear Type
Headcover, No Headgear Included
Net Weight (Imperial)
0.8 lb
Net Weight (Metric)
370.6 g
Product Color
Black
Product Series
M-Series
Product T

Dimensions and Classifications

Overall Height (Imperial)
7.8 in
Overall Height (Metric)
198.8 mm
Overall Length (Imperial)
3.33 in
Overall Length (Metric)
84.68 mm
Overall Width (Imperial)
11 in
Overall Width (Metric)
279.4 mm

3M™ DBI-SALA® Floor Mount Cast-in-Place Sleeve Davit Base

Details

Floor mount cast-in-place sleeve davit base
Built-in pins for fresh concrete
Flush mount design
360 degree davit mast rotation
PVC davit mast sleeve liner
Permanent installation with standard tools
Corrosion resistant plated hardware
Also available in stainless steel

Typical properties

Case Quantity
1
Connected Safety ID Equipped
No
Dimensions
30.40x20.30x23.60cm
Install Type
Portable
Net Weight (Imperial)
20.1 lb, 21.4 lb
Net Weight (Metric)
9.1 kg, 9.7 kg
Product Series
Advanced™
Product Type
Core Mount Sleeve Davit Bas

3M™ E-A-R™ One Touch™ Pro Adapter Plate 391-0010

3M Product Number 391-0010 3M ID 7100077665 UPC 00078371670504

Details

Mounting plate allows the 3M™ One Touch™ Pro Dispenser to be wall hung using the same hole locations as some other dispensers on the market. Hole layout on the plate eliminates the need to drill new holes when mounting a new dispenser.

This accessory is not needed to wall mount the 3M™ One Touch™ Pro Dispenser in a new location or to replace other dispensers.

*The NRR may overestimate the hearing protection provided during typical use.

Typical properties

Brands

E-A-R™

Case Quantity

1

Hearing Protection Style

Dispenser

Material

Metal

Metal Detectable

Yes

Product Color

Blue

Product Type

Accessory

Recommended Application

Assembly, Blasting, Cleaning, Demolition, Electrical, Facility Maintenance

3M™ E-A-R™ One Touch™ Pro Earplug Dispensing Mechanism, 391-0011, 1 ea/Case

3M Product Number 391-0000 3M ID 7010528303 UPC 00051131277489

Details

Dispenser makes it easy for workers to access earplugs
A simple turn of the hand drops earplug into a worker's hand one at a time
Drained catch tray, wind side shields and durable plastic construction safeguards earplugs in outdoor locations
Versatile design allows for placing on countertops or wall mounting
Bulk style dispenser eliminates waste from individually wrapped earplugs
Accepts 8 different 3M™ Earplugs in refill bottles
Refill bottle not included

Typical properties

Brands
E-A-R™
Product Color
Blue
eClass 14 Classification Group
40270102

3M™ Versaflo™ Back Pack Adaptor TR-655/37385 (AAD), for TR-600/800 PAPR, 1 EA

Part Number 37385 3M Product Number TR-655 3M ID 7100035843

Details

Enables TR-600 PAPR to be mounted on backpack BPK-01
Securely holds TR-600 in place
Multi-layer construction secures TR-600 in place

Typical properties

Brands

3M™

Case Quantity

1/pack

Compatible With

3M™ Versaflo™ TR-600 Series PAPR, 3M™ Versaflo™ TR-800 Series PAPR

Hazard Type

Silica

Product Series

TR-600

Product Type

Adapter

Recommended Application

Assembly & Mechanical, Paint Preparation,

3M™ Speedglas™ Welding Filter 9002NC 04-0000-21NC, 1 EA/Case

3M ID 7010386299 UPC 00051131276093

Details

Precision optics provide a view that appears lighter, brighter and more realistic for better control of the weld puddle
User interface easy to operate and maintain
Runs on CR2032 Lithium 3V batteries
Shade 3 light state with adjustable dark shades 8-12
Increase the service life of your equipment by checking it regularly

Typical properties

ADF Model
9002NC
Battery Type
ADF: CR2032
Brands
Speedglas™
Case Quantity
1
Compatible Welding Helmet
9000 Series
For Use With
3M™ Speedglas™ Welding Helmet 9002NC 04-0100-20NC
Headgear Type
Welding
Lens Shade
8 - 12
Lens Type
Auto-darken

3M™ Thumbscrew Clamp W-5102-2, 2/Case

3M Product Number W-5102-2 3M ID 7000130672 UPC 50051138153194

Details

For use with 3M™ Whitecap Helmets

Typical properties

Brands

3M™

CFM Capacity per Minute

100 CFM, 50 CFM

Compatible With

3M™ Breathe Easy™ PAPR

Product Color

Metal

Product Series

Whitecap

Product Type

Clamp

Supplied Air Respirator Style

MST Portable and Fixed Panels, Versaflo™ AP-600 Portable Pa

3M™ E-A-R™ Push-Ins™ SofTouch™ Earplugs 318-4001, Corded, Poly Bag, 2000 Pair/Case

3M Product Number 318-4001 3M ID 7000127215 UPC 10080529180183

Details

Soft, flexible foam conforms to the unique shape of each ear for comfortable noise reduction

Flexible stem makes fitting easy without touching the foam tip, keeping the tip clean even when hands are dirty

Poly bag keeps earplugs clean before use

Noise Reduction Rating (NRR)* 31 dB. CSA Class AL

Typical properties

Attenuation Rating

31.0 Decibel

Banded

No

Brands

E-A-R™

Case Quantity

2000

Cord Color

Blue

Cord Material

Vinyl

Cord Type

Vinyl

Corded

Yes

Dielectric

No

Dispenser Available

No

Earplug Color

Yellow/Blue

Earplug Material

Foam/Thermopla

3M™ Pomp Plus™ Probed Test Plugs 393-2017-50, 50 Pair/Case

3M ID 7010301959 UPC 10078371666085

Details

Test Probe for Pomp Plus™ Earplug

50 PR Per Case

3M PSD products are for occupational use only

*The NRR may overestimate the hearing protection provided during typical use

Typical properties

Brands

Pomp Plus™

Product Color

Orange

Product Type

Probed Test Earplug

Recommended Application

Health & Safety Testing

eClass 14 Classification Group

40270102

3M™ Speedglas™ Welding Helmet Cleaning Wipe 130100, 2/Bag

Part Number 130100 3M Product Number 130100 3M ID 7100243075

Details

To be used for cleaning the welding helmet inside and outside after use

Machine washable up to 200 times at 95 °C

To optimize the effective lifetime of your welding equipment and avoid the additional cost of replacement, regular maintenance is important

Typical properties

Brands

Speedglas™

Case Quantity

2/Bag

Compatible Welding Helmet

G5-02 Welding Helmets

Part Type

Accessory

Product Series

G5

Recommended Application

Welding

Recommended Industry

Construction, General Manufacturing, Military Maintenance, Repair

**3M™ PELTOR™ CH-5 High Attenuation Headset - MT73H450P3E-77
GB - Flex
Connector - Hard Hat Attached - 29dB NRR**

3M Product Number MT73H450P3E-77 GB 3M ID 7100099881 UPC 07318640067073

Details

Professional Hearing Protection with one of the Highest NRR values on the market (NRR 29dB)

High visibility color provide increased safety in exposed environments

Designed by 3M PELTOR and built tough for the working professional

Noise attenuating ear cups help provide hearing protection in environments with extreme hazardous noise

The Flex connector offers a wide range of options for customizing the headset to the radios available on the market

Typical properties

Attenuation Rating

29 dB

Audio Type

Communication

Auxiliary Port

Flex

Bluetooth

No

Brands

PELTOR™

Built In FM and or AM Radio

No

Built in 2-Way Radio

No

Case Quantity

1

Communication Direction

Two-way

Communication Type

Two-way Radio

C

3M™ PELTOR™ CH-5 High Attenuation Headset - MT73H450A-86 - NATO Wired - Headband - 31dB NRR

3M Product Number MT73H450A-86 3M ID 7100099883 UPC 07318640067066

Details

Professional Hearing Protection with one of the Highest NRR values on the market (NRR 31dB)

Low visibility Grey color blend in to the equipment used by defense professionals

Designed by 3M PELTOR and built tough for the Military professional

Noise attenuating ear cups help provide hearing protection in environments with extreme hazardous noise

Robust reinforced down lead cable with NATO wired NEXUS® TP-120 plug

Typical properties

Attenuation Rating

31 dB

Audio Type

Communication

Bluetooth

No

Brands

PELTOR™

Built In FM and or AM Radio

No

Built in 2-Way Radio

No

Case Quantity

1

Communication Direction

Two-way

Communication Type

Two-way Radio

Communication via Exter

3M™ DBI-SALA® Rollgliss™ Staggered Step Rescue Ladder 8516294, Web, 8 ft

Part Number 8516294 3M Product Number 8516294 3M ID 7012595692

Details

8 ft. (2.4 m) synthetic web rescue ladder with loops at both ends
Reinforced steps are staggered for easier descent and ascent
Compact, portable, and lightweight design
Length can be extended by combining ladder with more sections
Three strong carabiners provide a secure anchoring point
Optional anchorage plate designed for confined-space entry, sold separately
Recommended for use in construction, mining, oil and gas, transportation, and general industrial applications

Typical properties

Brands
DBI-SALA®
Case Quantity
1
CoWorker Controlled Ascent
No
CoWorker Controlled Descent
No
Connected Safety ID Equipped
No
Descent Type
Manual
Maximum Number of Users
One
Net Weight (Imperial)
5.07 lb
Net Weight (Metric)
2.3 kg
Produc

Dimensions and Classifications

Overall Length (Imperial)
8 ft
Overall Length (Metric)
2.4 m

3M™ DBI-SALA® Rollgliss™ 3:1 Rescue Positioning Device

Details

Rescue and positioning kit with pulley, two anchor slings, two carabiners, and carrying bag
Designed for raising, lowering, and positioning
3/8 in. (9.5 mm) kernmantle rope lifeline comes in varying lengths: 50 ft. (15.2 m), 100 ft. (30.5 m), 150 ft. (45.7 m), 200 ft. (61.0 m), and 400 ft. (121.9 m)
Manual control makes the ascent and descent smooth and secure
3:1 lifting ratio configuration (4:1 also available)
Pre-rigged system with unique speed-sensing braking mechanism makes the job more efficient
Integrated lock-out mechanism allows user to start and stop from anywhere
Corrosion-resistant construction is compact but strong
Recommended for use in the construction, transportation, mining, and utilities industries

Typical properties

Case Quantity

1

CoWorker Controlled Ascent

Yes

CoWorker Controlled Descent

Yes

Connected Safety ID Equipped

Yes

Descent Type

Vertical

Dimensions

11.40x3.80x25.40cm,4.50x1.50x10.00in

Lifeline Material

Kernmantle, Braided Polyester Cover with N

Dimensions and Classifications

Overall Length (Imperial)

50 ft, 100 ft, 150 ft, 200 ft, 400 ft

Overall Length (Metric)

15 m

3M™ DBI-SALA® Bare Steel Uni-Anchor 8510816

Part Number 8510816 3M Product Number 8510816 3M ID 7100157153

Details

Designed for use with the 3M™ DBI-SALA® Confined Space Portable Fall Arrest Post
Welds to steel floors or structures
Weldable, Bare steel construction
Permanent installation with standard welding processes
Available with or without tie-off anchor point
Recommended for use in multiple industries
Suitable for fall protection in electrical transformer applications

Typical properties

Anchor Install Type
Permanent
Brands
DBI-SALA®
Case Quantity
1
Connected Safety ID Equipped
No
Dimensions
25.40x20.30x73.00cm
For Use With
Fall Arrest Posts
Install Type
Permanent
Material
Steel
Net Weight (Imperial)
12 lb
Net Weight (Me

3M™ DBI-SALA® Confined Space Bare Steel Uni-Anchor with Tie-Off 8517412

Part Number 8517412 3M Product Number 8517412 3M ID 7100157154

Details

Designed for use with the 3M™ DBI-SALA® Confined Space Portable Fall Arrest Post

Welds to steel floors or structures

Weldable, Bare steel construction

Permanent installation with standard welding processes

Available with or without tie-off anchor point

Recommended for use in multiple industries

Suitable for fall protection in electrical transformer applications

Typical properties

Anchor Install Type

Permanent

Brands

DBI-SALA®

Case Quantity

1

Connected Safety ID Equipped

No

Dimensions

25.40x20.30x73.00cm

For Use With

Fall Arrest Posts

Install Type

Permanent

Material

Steel

Net Weight (Imperial)

12.3 lb

Net Weight (

3M™ DBI-SALA® SSB Cable Climb Assist System Lifeline Assembly 3512350, 1/4 in Galvanized Steel 7 x 19, 350 ft

Part Number 3512350 3M Product Number 3512350 3M ID 7012819344

Details

No limit to length of system
Aluminum housing
Aids workers and provides fall protection while climbing lengthy ladders and towers

Typical properties

Attachment Type
None
Brands
DBI-SALA®
Case Quantity
1
Connected Safety ID Equipped
No
Install Type
Permanent
Lifeline Length (Imperial)
350 ft
Lifeline Length (Metric)
106.68 m
Lifeline Material
Galvanized Steel
Maximum Number of Users
On

Dimensions and Classifications

Overall Length (Imperial)
350 ft

3M™ DBI-SALA® SSB Cable Climb Assist System Lifeline Assembly 3530300, 1/4 in Stainless Steel 7 x 19, 300 ft

Part Number 3530300 3M Product Number 3530300 3M ID 7012819384

Details

No limit to length of system
Aluminum housing
Aids workers and provides fall protection while climbing lengthy ladders and towers

Typical properties

Attachment Type
None
Brands
DBI-SALA®
Connected Safety ID Equipped
No
Install Type
Permanent
Lifeline Length (Imperial)
300 ft
Lifeline Length (Metric)
91.44 m
Lifeline Material
Stainless Steel
Maximum Number of Users
One
Product Series
S

Dimensions and Classifications

Overall Length (Imperial)
300 ft

3M™ DBI-SALA® SSB Cable Climb Assist System Lifeline Assembly 3530150, 1/4 in Stainless Steel 7 x 19, 150 ft

Part Number 3530150 3M Product Number 3530150 3M ID 7012819382

Details

No limit to length of system
Aluminum housing
Aids workers and provides fall protection while climbing lengthy ladders and towers

Typical properties

Attachment Type
None
Brands
DBI-SALA®
Case Quantity
1
Connected Safety ID Equipped
No
Install Type
Permanent
Lifeline Length (Imperial)
150 ft
Lifeline Length (Metric)
45.72 m
Lifeline Material
Stainless Steel
Maximum Number of Users
One

Dimensions and Classifications

Overall Length (Imperial)
150 ft

3M™ DBI-SALA® SSB Cable Climb Assist System Lifeline Assembly 3512100, 1/4 in Galvanized Steel 7 x 19, 100 ft

Part Number 3512100 3M Product Number 3512100 3M ID 7012819326

Details

No limit to length of system
Aluminum housing
Aids workers and provides fall protection while climbing lengthy ladders and towers

Typical properties

Attachment Type
None
Brands
DBI-SALA®
Case Quantity
1,1 EA/Case
Connected Safety ID Equipped
No
Install Type
Permanent
Lifeline Length (Imperial)
100 ft
Lifeline Length (Metric)
30.48 m
Lifeline Material
Galvanized Steel
Maximum Number of

Dimensions and Classifications

Overall Length (Imperial)
100 ft

3M™ DBI-SALA® SSB Cable Climb Assist System Lifeline Assembly 3512300, 1/4 in Galvanized Steel 7 x 19, 300 ft

Part Number 3512300 3M Product Number 3512300 3M ID 7012819341

Details

No limit to length of system
Aluminum housing
Aids workers and provides fall protection while climbing lengthy ladders and towers

Typical properties

Attachment Type
None
Brands
DBI-SALA®
Case Quantity
1
Connected Safety ID Equipped
No
Install Type
Permanent
Lifeline Length (Imperial)
300 ft
Lifeline Length (Metric)
91.44 m
Lifeline Material
Galvanized Steel
Maximum Number of Users
One

Dimensions and Classifications

Overall Length (Imperial)
300 ft

3M™ DBI-SALA® SSB Cable Climb Assist System Lifeline Assembly 3512150, 1/4 in Galvanized Steel 7 x 19, 150 ft

Part Number 3512150 3M Product Number 3512150 3M ID 7012819331

Details

No limit to length of system
Aluminum housing
Aids workers and provides fall protection while climbing lengthy ladders and towers

Typical properties

Attachment Type
None
Brands
DBI-SALA®
Case Quantity
1
Connected Safety ID Equipped
No
Dimensions
150 ft
Install Type
Permanent
Lifeline Length (Imperial)
150 ft
Lifeline Length (Metric)
45.72 m
Lifeline Material
Galvanized Steel
Maximum

Dimensions and Classifications

Overall Length (Imperial)
150 ft
Overall Length (Metric)
45.7 m

3M™ Scott™ RIT-Pak III Emergency Air Supply System

3M ID B5005047164

Details

High-pressure charging wand compatible with all SCBA equipped with a RIC/UAC

Compatible with 3M Scott Air-Pak SCBA models equipped with EBSS or Dual EBSS

Compatible with all SCBA compliant to the NFPA 1981, 2018 Edition standard and equipped with Universal EBSS

Low-pressure hose and manifold provides compatibility with other non-3M Scott SCBA, using separate adapters and airline fittings

Hi-Viz orange with 3M™ Scotchlite™ Reflective Material

Skid plate for ease of dragging and added durability

External pressure gauge with HUD-style lights

Audible bell alarm to differentiate low-air alarm from other firefighters SCBA

Available in 2.2, 4.5, or 5.5 cylinder pressures

Accommodates up to a 75-min cylinder duration

Typical properties

Brands

Scott™

Product Type

Self-contained Breathing Apparatus

3M™ DBI-SALA® Lad-Saf™ Static Wire Rope Grab 5000338, 1 EA

Part Number 5000338 3M Product Number 5000338 3M ID 7100207470

Details

Manual design allows user to position in place
Ideal for work positioning or restraint
Extremely rugged all-metal system
Cam locking system for safety
Detachable anywhere along the lifeline
Durable and lightweight construction
For use with 3/8 in. (9.5 mm) 7x19 cable lifeline
Use with 3 ft. (0.9 m) shock absorbing lanyard

Typical properties

Attachment Type
None
Brands
DBI-SALA®
Case Quantity
1
Connected Safety ID Equipped
No
For Use With
3/8 in Wire Rope Lifeline
Install Type
Temporary
Lifeline Material
Galvanized Steel
Maximum Number of Users
One
Net Weight (Imperial)
2.5 l

Dimensions and Classifications

Overall Height (Imperial)
5.5 in
Overall Height (Metric)
14 cm
Overall Length (Imperial)
2.5 in
Overall Length (Metric)
6.4 cm
Overall Width (Imperial)
10.5 in
Overall Width (Metric)
26.7 cm

3M™ PELTOR™ Replacement Case TEP-300C CY, Coyote Brown, 20 ea/Case

3M Product Number TEP-300C CY 3M ID 7100227630 UPC 00638060430019

Details

Micro USB-C Charging Port enables the charging of the earplugs when plugged into a computer or wall socket (cable not included)

Portable Charging Compartment provides up to 10 recharging cycles with AA or AAA batteries

Rubber sealing ring helps protect earplugs and charging case in wet and dirty environments

Typical properties

Brands

PELTOR™

Case Quantity

20 ea / cs

Compatible With

TEP-300 Tactical Earplug

Product Color

Coyote Brown

Product Type

Case

eClass 14 Classification Group

40270191

3M™ PELTOR™ Replacement Case TEP-300C GE, Gray, 20 ea/Case

3M Product Number TEP-300C GE 3M ID 7100227638 UPC 00638060429990

Details

Micro USB-C Charging Port enables the charging of the earplugs when plugged into a computer or wall socket (cable not included)
Portable Charging Compartment provides up to 10 recharging cycles with AA or AAA batteries
Rubber sealing ring helps protect earplugs and charging case in wet and dirty environments

Typical properties

Brands
PELTOR™
Case Quantity
20 ea / cs
Compatible With
TEP-300 Tactical Earplug
Product Color
Gray
Product Type
Case
eClass 14 Classification Group
40270191

3M™ Scott™ E-Z Airline Supplied Air Respirator

3M ID B5005047149

Details

Type C pressure demand respirator for non-IDLH environments
Ideal for use where extended wear times are needed in environments that are not immediately dangerous to life or health (non-IDLH), such as painting, plant maintenance operations and welding
NIOSH approved with 3M Scott AV-Series and Weld-O-Vista facepieces
Available with a wide range of fittings and approved hoses, up to 300 ft
EZ-Flo Regulator with Modulair™ Quick Connect option enables easy removal when needed
E-Z Flo Modulair regulator allows for personal issue regulators that can also be used with the Industrial SCBA (ISCBA), ACSi SCBA, and Ska-Pak Plus respirators for reduced training and inventory costs

Typical properties

Brands
Scott™
Compatible Facepiece
AV-3000 SureSeal
Connection Type
Compressed Air Line
Gauge Type
None
In-line Air Filter Included
No
Product Type
Supplied Air Respirator
Specifications Met
NIOSH 42 CFR

3M™ Scott™ Air-Pak™ 75i SCBA

3M ID B5005047165

Details

Redundant safety features include Vibralert (end-of-service-time indicator) and a dual redundant pressure reducer for user peace of mind

Vibralert end-of-service time indicator provides audible and tactile alert that user can feel, to help ensure the user knows when they need to take action

The E-Z Flo regulator is designed for gloved hands, enables easy breathing, and has a two step secure attachment to help ensure worker confidence

NIOSH approved for use with 3M Scott AV series facepieces that can also be used for APR, PAPR, supplied air, and SCBA applications

Available in 2216, 4500 or 5500 psi variants and 30, 45, 60 or 75 minute durations

Optional extended duration airline for added respirator versatility

Typical properties

Brands

Scott™

Buckle Type

Parachute

Harness Material

Kevlar®

Included Regulator

E-Z Flo

Product Type

Self-contained Breathing Apparatus

3M™ Powered & Supplied Air Breathing Tubes

Details

Quickly allows attachment between headgear and PAPR air filter unit
NIOSH approved when used as part of a complete system

Typical properties

Brands

3M™

CFM Capacity per Minute

100 CFM, 50 CFM, 51 CFM, 54 CFM

Case Quantity

1

Clip-on Welding Shield

No

Compatible Respirator Type

PAPR

Compatible With

3M™ Breathe Easy™ PAPR, 3M™ Versaflo™ TR-300 Series PAPR, 3M™
Versaflo™ TR-600 Series P

3M™ X5-S4PTCS1 Standard 4 Point Chin Strap with buckle for SecureFit™ Safety Helmet

3M Product Number X5-S4PTCS1 3M ID 7100207831 UPC 50076308944983

Details

Easy adjustment
Fits 3M™ SecureFit™ X5000 Series Safety Helmets

Typical properties

Brands
SecureFit™
Case Quantity
10
Compatible Hard Hat
X5000
For Use With
Hard Hats
Material
Nylon
Product Color
Black
Product Series
X5000
Product Type
Chin Strap, Hard Hat Accessory
Recommended Application
Demolition, Forestry, Oil & Ga

3M™ DBI-SALA® Lad-Saf™ Mobile Rope Grab Kit

Details

Complete rope grab fall protection kit
Portable and hands-free mobile rope grab
Lightweight and compact 3 ft. (0.9 m) shock absorbing lanyard
Durable and lightweight blended rope lifeline with snap hook
Compact, removable counterweight keeps lifeline taut
Reusable and extremely durable tie-off adaptor
Durable carrying bag with handles
Equipped with 3M™ Connected Safety ID (CSID)

Typical properties

Brands
DBI-SALA®
Case Quantity
1
Connected Safety ID Equipped
Yes
Harness Connection Hook Material
Zinc Plated Steel
Harness Connection Type
Snap Hook
Install Type
Temporary
Kit Includes
Carrying Bag, Counterweight, Mobile Rope Grab, Rope Lif

3M™ Scott™ EPIC 3 Voice Amplifier

3M ID B5005218009

Details

Automatic shut-off feature reduces costs of battery replacement and improves equipment readiness

Intrinsically safe for use with commercially available alkaline and NiMH AAA batteries

Durable, rugged design is robust enough to withstand day-to-day rigors, even in the most extreme applications

Ribbed, textured surface establishes more secure handling even with wet-gloved hands

Power button with tactile surface makes it easy to recognize activation with a gloved hand

Angled, directional speaker projects an amplified voice in the direction the user is facing

Upgradeable to include radio interface and radio direct interface functionality
NFPA- and NIOSH-compliant as an accessory to compatible Air-Pak SCBA models

Typical properties

Brands

Scott™

3M™ SecureFit™ 100 Series Safety Glasses

Details

3M's innovative temple design features slotted ribs that provide comfortable pressure equalization, allowing the temples to flex and self-adjust to the size of the wearer's head

Curved temples apply pressure to the less sensitive back of the head, instead of the temples, achieving a comfortable fit even during rapid head movement

Sporty design with contemporary lens shape and a sleek profile

SecureFit's flat and flexible temple design combines well with 3M™ Protective Earmuffs

Choose from models with anti-scratch or anti-fog/anti-scratch coating

Bulk packaging available (100 per case)

U6 rated polycarbonate lenses absorb 99.9% of UVA, UVB, and UVC rays between 200 nm and 380 nm

Workers can feel confident wearing 3M eye protection that meets the Impact-Rated Protector requirement of the ANSI-ISEA Z87.1-2020 Standard

Typical properties

Anti Fog Lens

No, Yes

Brands

SecureFit™

Case Quantity

100,20

Class

Economy

Comfort Features

3M™ Pressure Diffusion Temple Technology

Frame Color

Clear

Frame Material

Polycarbonate

Frame Style

Frameless

Gasket Included

No

Hard Coat Lens

3M™ DBI-SALA® FlexiGuard™ M200 Adjustable Height Mast

Details

- Powder coated steel upright and gusset components
- Extended rail-length increases safe working area compared to our previous jib systems
- Extended anchor height enhances capabilities in various applications compared to our previous jib systems
- Automatic mast lock helps prevents uncontrolled mast movement
- Aluminum extruded trolley rail
- Rotating mast up to 360 degrees with flip up rotation handle
- Permanent or portable mounted designs available
- Stainless steel / nylon construction
- Power assisted height adjustment capability for adjustable models
- Integrated level indicators (Counterweight Bases). Removable counterweight box (Counterweight Bases) with built in fork pockets and lifting ring attachment points (Lifting Kit sold separately). Open multi-directional base designed to accommodate a wide array of fork shapes and sizes
- 3M™ Safety-Walk™ Slip Resistant walking surface (counterweight Bases)
- Additional system mobility with optional caster wheel kit

Typical properties

- Connected Safety ID Equipped
No
- Install Type
Temporary/Portable
- Manufacturing Origin
USA
- Maximum Height (Imperial)
15 ft, 20 ft, 25 ft, 30 ft
- Maximum Height (Metric)
4.6 m, 6.1 m, 7.6 m, 9.1 m
- Maximum Number of Users
One, Two
- Minimum Height (I

Dimensions and Classifications

- Overall Height (Metric)
0 mm, 640 mm
- Overall Length (Metric)
0 mm, 6150 mm
- Overall Width (Metric)
0 mm, 122 mm

3M™ E-A-R™ UltraFit™ 27 Earplugs 340-8002, Corded, 400 Pair/Case

3M Product Number 340-8002 3M ID 7000127188 UPC 10080529400557

Details

Ergonomic pistol grip for an easier fit
Triple-flange provides proven protection without rolling or touching plug during insertion
Conforms well to the ear's natural oval shape
Washable and reusable
Corded Earplugs
Noise Reduction Rating (NRR)*: 27 dB. CSA Class AL

Typical properties

Attenuation Rating
27.0 Decibel
Banded
No
Brands
E-A-R™
Case Quantity
400
Cord Color
Clear
Cord Type
Vinyl
Corded
Yes
Dielectric
No
Dispenser Available
No
Earplug Color
Yellow
Earplug Material
Elastomeric Polymer
Earplug Shape
Flang

3M™ E-A-R™ UltraFit™ 27 Earplugs 340-8001, Uncorded, 400 Pair/Case

3M Product Number 340-8001 3M ID 7000127189 UPC 10080529400540

Details

Ergonomic pistol grip for an easier fit
Triple-flange provides proven protection without rolling or touching plug during insertion
Washable and reusable
Noise Reduction Rating (NRR)*: 27 dB. CSA Class AL

Typical properties

Attenuation Rating
27.0 Decibel
Banded
No
Brands
E-A-R™
Case Quantity
400
Cord Type
None
Corded
No
Dielectric
No
Dispenser Available
No
Earplug Color
Yellow
Earplug Material
Elastomeric Polymer
Earplug Shape
Flanged
Earplug Size
Reg

3M™ Skull Screws™ Probed Test Plugs 393-2012-50, 50 pair/case, 10 pair/bag, 5 bags/case

3M Product Number 393-2012-50 3M ID 7000128264 UPC 10093045937131

Details

pecially probed version of the standard plug
his product works with the E-A-Rfit™ Validation System
allows you to conduct an earplug fit test for the P1300 and P1301 earplugs
*The NRR may overestimate the hearing protection provided during typical use

Typical properties

Brands
3M™
Case Quantity
5
Insertion Style
Push-to-fit
Material
Polyurethane
Product Color
Silver
Product Series
E-A-Rfit
Product Type
Probed Test Earplug
Recommended Application
Health & Safety Testing
Recommended Industry
Commercial Bui

3M™ H-700 Cap Style and H-800 Full Brim Series Hard Hat Scotchlite™ Reflective Striping Kit H-SR-S, 20 each set

3M Product Number H-SR-S 3M ID 7010341312 UPC 00078371670238

Details

3M™ Scotchlite™ Reflective is bright, durable, and high quality
Safety of workers due to enhanced visibility in low light
Easy application
Approximately 12 square inches of total reflective material

Typical properties

Brands
Scotchlite™
Compatible Hard Hat
H-700, H-800
For Use With
Hard Hats
Material
3M™ Scotchlite™ Reflective
Product Color
Silver
Product Type
Reflective Striping Kit
Recommended Application
Furnace Operation
Recommended Industry
Construc

3M™ X5-REFKIT reflective sticker kit for SecureFit™ Safety Helmet 10 KITS /CASE

3M Product Number X5-REFKIT 3M ID 7100175590 UPC 04054596595521

Details

Increases visibility in low-light conditions

Designed to fit SecureFit™ Safety Helmet series X5000 and X5500

Pressure-sensitive adhesive backed pieces

3M™ SecureFit™ X5000 Safety Helmet Pressure Diffusion Ratchet Suspension fits hat sizes 6-1/4 to 7-7/8 inches (50 to 63 cm) head circumference

Typical properties

Brands

SecureFit™

Case Quantity

10

Compatible Hard Hat

X5000

For Use With

3M™ Safety Helmet

Product Color

Silver

Product Series

X5000

Product Type

Reflective Striping Kit

Recommended Application

Construction, Demolition, Forestry, Oil & Gas

3M™ Scott™ Airline Hose Assemblies

Details

Available fittings include Hansen, Schrader, Foster, Hansen HK, or Cejn
Available in designated segments with quick-disconnect couplings
Black neoprene rubber material

Typical properties

Airline Connector Brand
CEJN, Foster, Hansen, Hansen HK, Schrader
Airline Hose Length (Imperial)
6 ft, 10 ft, 25 ft, 50 ft, 100 ft, 150 ft, 300 ft
Airline Hose Length (Metric)
1.8 m, 3 m, 7.6 m, 15.2 m, 30.5 m, 45.7 m, 91.4 m
Airline Hose Material

3M™ DBI-SALA® D-ring Attachment 0.5" x 2.25" 1500003, 10 EA/PACK

3M Product Number 1500003 3M ID 7100214250 UPC 00852684930636

Details

Compatible with 3M™ DBI-SALA® Fall Protection for Tools accessories
Provides workers an attachment point to secure tools and accessories while working at height
Multiple attachment point and capacity options designed for a variety of applications

Typical properties

Brands
DBI-SALA®
Case Quantity
10
Connected Safety ID Equipped
No
Dimensions
0.50 x 2.25 inch
Manufacturing Origin
Taiwan
Net Weight (Imperial)
0.3 lb
Net Weight (Metric)
0.13 kg
Product Type
D-ring Attachment 0.5 in x 2.25 in
Recommended

Dimensions and Classifications

Overall Height (Metric)
8.78 mm
Overall Length (Metric)
304.8 mm

3M™ DBI-SALA® D-Ring Attachment with Cord 1500009, 10 EA/PACK

3M Product Number 1500009 3M ID 7100214245 UPC 00852684930735

Details

Compatible with 3M™ DBI-SALA® Fall Protection for Tools accessories
Provides workers an attachment point to secure tools and accessories while working at height
Multiple attachment point and capacity options designed for a variety of applications

Typical properties

Brands
DBI-SALA®
Case Quantity
10
Connected Safety ID Equipped
No
Dimensions
1.00 x 3.50 inch
Manufacturing Origin
Taiwan
Net Weight (Metric)
0.28 kg
Product Type
D-ring Attachment with Cord
Recommended Industry
Construction, General Indust

Dimensions and Classifications

Overall Height (Metric)
35.56 mm
Overall Length (Metric)
307.34 mm

3M™ Cinch Tool Attachment Point 1500011, 35 lb Capacity

3M Product Number 1500011 3M ID 7012818069 UPC 00852684933002

Details

Compatible with 3M™ DBI-SALA® Fall Protection for Tools accessories
Provides workers an attachment point to secure tools and accessories while working at height
Multiple attachment point and capacity options designed for a variety of applications

Typical properties

Brands

DBI-SALA®

Case Quantity

1

Connected Safety ID Equipped

No

Product Color

Yellow

Product Type

Tool Cinch Medium Duty

Recommended Industry

Construction, General Industrial, Mining, Oil & Gas, Transportation, Utilities, Wind Energy
Specific

3M™ Single Wing Cinch Tool Attachment Point 1500013, 35 lb Capacity

3M Product Number 1500013 3M ID 7100258130 UPC 00852684932920

Details

Compatible with 3M™ DBI-SALA® Fall Protection for Tools accessories
Provides workers an attachment point to secure tools and accessories while working at height
Multiple attachment point and capacity options designed for a variety of applications

Typical properties

Brands

DBI-SALA®

Case Quantity

1

Connected Safety ID Equipped

No

Product Color

Yellow

Product Type

Tool Cinch - Single Wing Medium Duty

Recommended Industry

Construction, General Industrial, Mining, Oil & Gas, Transportation, Utilities, Wind En

3M™ Dual Wing Cinch Tool Attachment Point 1500017, 80 lb Capacity

3M Product Number 1500017 3M ID 7100241914 UPC 00852684934580

Details

Compatible with 3M™ DBI-SALA® Fall Protection for Tools accessories
Provides workers an attachment point to secure tools and accessories while working at height
Multiple attachment point and capacity options designed for a variety of applications

Typical properties

Brands

DBI-SALA®

Case Quantity

1

Connected Safety ID Equipped

No

Product Color

Yellow

Product Type

Tool Cinch - Dual Wing - Heavy Duty

Recommended Industry

Construction, General Industrial, Mining, Oil & Gas, Transportation, Utilities, Wind Ene

3M™ DBI-SALA® Quick Wrap Tape II 1500171, Blue 1"x216"

3M Product Number 1500171 3M ID 7100204331 UPC 00840779151332

Details

Compatible with 3M™ DBI-SALA® Fall Protection for Tools accessories
Provides workers an attachment point to secure tools and accessories while working at height
Multiple attachment point and capacity options designed for a variety of applications

Typical properties

Brands

DBI-SALA®

Case Quantity

1

Connected Safety ID Equipped

No

Dimensions

2.87 x 2.87 x 1.00 inch

Net Weight (Imperial)

0.21 lb

Product Type

Quick Wrap Tape

Recommended Industry

Construction, General Industrial, Mining, Oil & Gas, Transport

Dimensions and Classifications

Overall Length (Imperial)

18 ft

3M™ Dual Wing Cinch Tool Attachment Point 1500015, 35 lb Capacity

3M Product Number 1500015 3M ID 7100260275 UPC 00852684932968

Details

Compatible with 3M™ DBI-SALA® Fall Protection for Tools accessories
Provides workers an attachment point to secure tools and accessories while working at height
Multiple attachment point and capacity options designed for a variety of applications

Typical properties

Brands
DBI-SALA®
Case Quantity
1
Connected Safety ID Equipped
No
Manufacturing Origin
Taiwan
Net Weight (Metric)
0.09 kg
Product Color
Yellow
Product Type
Tool Cinch - Dual Wing Medium Duty
Recommended Industry
Construction, General Industr

Dimensions and Classifications

Overall Height (Metric)
5.94 mm
Overall Length (Metric)
192.09 mm

3M™ Hook2Quick-Ring Coil Tool Tether with Tail 1500065, 2 lb Capacity, 3 - 62 in

3M Product Number 1500065 3M ID 7100270184 UPC 00852684930988

Details

Compatible with 3M™ DBI-SALA® Fall Protection for Tools accessories
Provides workers an attachment point to secure tools and accessories while working at height
Multiple attachment point and capacity options designed for a variety of applications

Typical properties

Brands
DBI-SALA®
Case Quantity
1
Connected Safety ID Equipped
No
Net Weight (Imperial)
0.2 lb
Product Color
Black, Yellow
Product Type
Hook2Quick Ring Coil Tool Tether with Tail
Recommended Industry
Construction, General Industrial, Mining, O

3M™ Medium Quick Ring Tool Attachment Point 1500025, 2 lb Capacity, 1 in, 25 ea/Pack

3M Product Number 1500025 3M ID 7100275356 UPC 00852684932579

Details

Compatible with 3M™ DBI-SALA® Fall Protection for Tools accessories
Provides workers an attachment point to secure tools and accessories while working at height
Multiple attachment point and capacity options designed for a variety of applications

Typical properties

Brands
DBI-SALA®
Case Quantity
25
Connected Safety ID Equipped
No
Dimensions
1.00 x 0.14 inch
Manufacturing Origin
USA
Net Weight (Metric)
0.13 kg
Product Type
Quick Ring
Recommended Industry
Construction, General Industrial, Mining, Oil &

Dimensions and Classifications

Overall Height (Metric)
6.44 mm
Overall Length (Metric)
177.8 mm

3M™ PELTOR™ WS™ ProTac XPI Headsets

Details

Protective communication solution for hands-free, clear communication in noisy environments

Helps provide hearing protection when exposed to hazardous noise

Bluetooth® multipoint technology for simultaneous, wireless connection to two devices

Environmental listening technology assists workers to hear environmental sounds in low noise and helps provide protection when it's loud

Water and dust-proof noise-cancelling microphone (IP68) for clear speech transmission in noisy and harsh environments

Typical properties

Attenuation Rating

26 dB, 24 dB

Audio Type

Communication

Auxiliary Port

FLX2

Battery Life

45 Hours

Battery Type

AA or Rechargeable NiMH Pack, Disposable AA

Bluetooth

Yes

Built In FM and or AM Radio

No

Built in 2-Way Radio

No

CSA Class

CSA

3M™ BX™ Reader Protective Eyewear 11375-00000-20, Clear Lens, Silver Frame, +2.0 Diopter, 20 ea/Case

3M Product Number 11375-00000-20 3M ID 7000052794 UPC 10078371620476

Details

Sleek, contoured design combines style and function
Magnifying +1.5 diopters combine eye protection with reading enhancement
Adjustable length temples and lens angle allow for customized fit
Polycarbonate lenses absorb 99.9% UVA and UVB up to 380 nm

Typical properties

ANSI Requirements

ANSI Z87.1-2003 and CSA Z94.3-2007

Anti Fog Lens

No

Brands

BX™

Case Quantity

20

Class

Value

Comfort Features

Adjustable length temples, Adjustable lens angles, Soft adjustable nose bridge

Diopter

2.0

Eyewear Range

Value

F

Dimensions and Classifications

Overall Height (Imperial)

2 in

Overall Height (Metric)

5.08 cm

Overall Length (Imperial)

2 in

Overall Length (Metric)

5.08 cm

Overall Width (Imperial)

2.2 in

Overall Width (Metric)

5.588 cm

3M™ BX™ Dual Reader Protective Eyewear 11459-00000-20, Clear Anti-Fog Lens, Silver/Black Frame, +2.5 Top/Bottom Diopter, 20 ea/Case

3M Product Number 11459-00000-20 3M ID 7000127663 UPC 10078371114593

Details

Molded-in magnifying diopters on upper and lower lens
Sleek, contoured and fully adjustable
Clear anti fog lens

Typical properties

Anti Fog Lens

Yes

Brands

BX™

Case Quantity

20

Class

Value

Comfort Features

Adjustable length temples, Adjustable lens angles, Soft adjustable nose bridge

Diopter

2.5

Eyewear Range

Value

Frame Color

Silver and Black

Frame Material

Plastic

3M™ BX™ Reader Protective Eyewear 11379-00000-20, Grey Lens, Silver Frame, +2.5 Diopter, 20 ea/Case

3M Product Number 11379-00000-20 3M ID 7000127494 UPC 10078371620513

Details

Sleek, contoured design combines style and function
Magnifying +1.5 diopters combine eye protection with reading enhancement
Adjustable length temples and lens angle allow for customized fit
Polycarbonate lenses absorb 99.9% UVA and UVB up to 380 nm

Typical properties

ANSI Requirements

ANSI Z87.1-2003 and CSA Z94.3-2007

Anti Fog Lens

No

Brands

BX™

Case Quantity

20

Class

Value

Comfort Features

Adjustable length temples, Adjustable lens angles, Soft adjustable nose bridge

Diopter

2.5

Eyewear Range

Value

F

Dimensions and Classifications

Overall Height (Imperial)

2 in

Overall Height (Metric)

5.08 cm

Overall Length (Imperial)

2 in

Overall Length (Metric)

5.08 cm

Overall Width (Imperial)

2.2 in

Overall Width (Metric)

5.588 cm

3M™ BX™ Reader Protective Eyewear 11376-00000-20, Clear Lens, Silver Frame, +2.5 Diopter, 20 ea/Case

3M Product Number 11376-00000-20 3M ID 7000127491 UPC 10078371620483

Details

Sleek, contoured design combines style and function
Magnifying +1.5 diopters combine eye protection with reading enhancement
Adjustable length temples and lens angle allow for customized fit
Polycarbonate lenses absorb 99.9% UVA and UVB up to 380 nm

Typical properties

ANSI Requirements

ANSI Z87.1-2003 and CSA Z94.3-2007

Anti Fog Lens

No

Brands

BX™

Case Quantity

20

Class

Value

Comfort Features

Adjustable length temples, Adjustable lens angles, Soft adjustable nose bridge

Diopter

2.5

Eyewear Range

Value

F

Dimensions and Classifications

Overall Height (Imperial)

2 in

Overall Height (Metric)

5.08 cm

Overall Length (Imperial)

2 in

Overall Length (Metric)

5.08 cm

Overall Width (Imperial)

2.2 in

Overall Width (Metric)

5.588 cm

3M™ BX™ Dual Reader Protective Eyewear 11457-00000-20, Clear Anti-Fog Lens, Silver/Black Frame, +1.5 Top/Bottom Diopter. 20 ea/Case

3M Product Number 11457-00000-20 3M ID 7000127661 UPC 10078371114579

Details

Molded-in magnifying diopters on upper and lower lens
Sleek, contoured and fully adjustable
Clear anti fog lens

Typical properties

Anti Fog Lens

Yes

Brands

BX™

Case Quantity

20

Class

Value

Comfort Features

Adjustable length temples, Adjustable lens angles, Soft adjustable nose bridge

Diopter

1.5

Eyewear Range

Value

Frame Color

Silver and Black

Frame Material

Plastic

3M™ BX™ Reader Protective Eyewear 11377-00000-20, Grey Lens, Silver Frame, +1.5 Diopter, 20 ea/Case

3M Product Number 11377-00000-20 3M ID 7000127492 UPC 10078371620490

Details

Sleek, contoured design combines style and function
Magnifying +1.5 diopters combine eye protection with reading enhancement
Adjustable length temples and lens angle allow for customized fit
Polycarbonate lenses absorb 99.9% UVA and UVB up to 380 nm

Typical properties

ANSI Requirements

ANSI Z87.1-2003 and CSA Z94.3-2007

Anti Fog Lens

No

Brands

BX™

Case Quantity

20

Class

Value

Comfort Features

Adjustable length temples, Adjustable lens angles, Soft adjustable nose bridge

Diopter

1.5

Eyewear Range

Value

F

Dimensions and Classifications

Overall Height (Imperial)

2 in

Overall Height (Metric)

5.08 cm

Overall Length (Imperial)

2 in

Overall Length (Metric)

5.08 cm

Overall Width (Imperial)

2.2 in

Overall Width (Metric)

5.588 cm

3M™ BX™ Reader Protective Eyewear 11378-00000-20, Grey Lens, Silver Frame, +2.0 Diopter, 20 ea/Case

3M Product Number 11378-00000-20 3M ID 7000127493 UPC 10078371620506

Details

Sleek, contoured design combines style and function
Magnifying +1.5 diopters combine eye protection with reading enhancement
Adjustable length temples and lens angle allow for customized fit
Polycarbonate lenses absorb 99.9% UVA and UVB up to 380 nm

Typical properties

ANSI Requirements

ANSI Z87.1-2003 and CSA Z94.3-2007

Anti Fog Lens

No

Brands

BX™

Case Quantity

20

Class

Value

Comfort Features

Adjustable length temples, Adjustable lens angles, Soft adjustable nose bridge

Diopter

2.0

Eyewear Range

Value

F

Dimensions and Classifications

Overall Height (Imperial)

2 in

Overall Height (Metric)

5.08 cm

Overall Length (Imperial)

2 in

Overall Length (Metric)

5.08 cm

Overall Width (Imperial)

2.2 in

Overall Width (Metric)

5.588 cm

3M™ BX™ Dual Reader Protective Eyewear 11458-00000-20, Clear Anti-Fog Lens, Silver/Black Frame, +2.0 Top/Bottom Diopter, 20 ea/Case

3M Product Number 11458-00000-20 3M ID 7000127662 UPC 10078371114586

Details

Molded-in magnifying diopters on upper and lower lens
Sleek, contoured and fully adjustable
Clear anti fog lens

Typical properties

Anti Fog Lens

Yes

Brands

BX™

Case Quantity

20

Class

Value

Comfort Features

Adjustable length temples, Adjustable lens angles, Soft adjustable nose bridge

Diopter

2.0

Eyewear Range

Value

Frame Color

Silver and Black

Frame Material

Plastic

3M™ Welding Clear Visors/Plates

Details

Replacement parts for original plates and visors
Helps protect the welding lens from welding sparks and spatter
Replace when parts become deeply pitted or too dirty to clean
Regularly clean with a lint-free cloth
Increase the service life of your equipment by checking it regularly

Typical properties

Brands

3M™

Case Quantity

5

Compatible Welding Helmet

9100 FX Welding Helmets, 9100 FX-Air Welding Helmets, 9100 MP Welding Helmets

Features

9100 Series Accessory, Eye & Face Protection

For Use With

3M™ Speedglas™ 9100MP Welding Helmets
Headgear

3M™ Protecta® P50 Safety Harness

Details

Parachute torso adjusters
Polyester web
Available in a variety of configurations

Typical properties

Body Belt
No
Brands
PROTECTA®
Buckle Type
Pass-through, Tongue Buckle
Case Quantity
1
Chest Buckle Material
Zinc Plated Steel
Connected Safety ID Equipped
No
D-ring Placement
Back, Front, Side
Harness Application
Climbing, General Purpose,

**3M™ Advanced Particulate Filter 2296, P100, with Nuisance Level
Acid Gas
Relief 100 EA/Case**

3M Product Number 2296 3M ID 7000127450 UPC 50051131171713

Typical properties

Accessories

Yes

Aerosol Type

Oil and Non-Oil

Brands

3M™

Cartridge or Filter Type

Particulate

Case Quantity

100/case

Clip-on Welding Shield

Yes

Compatible Respirator

3M™ Full Facepieces 6000, 3M™ Full Facepieces 7800 Series, 3M™ Full
Facepiece

Dimensions and Classifications

Overall Height (Imperial)

4.3 in

Overall Length (Imperial)

4.3 in

3M™ Rugged Comfort 6581 / 55886 Head Harness Assembly, System Component

3M Product Number 6581 3M ID 7000128251 UPC 50051141558863

Details

Optimum fit and comfort with four point adjustable cradle
Lasting performance and improved elasticity Polyester/Spandex straps
Replacement part for the standard 3M™ 6500 Series
20 each per case

Typical properties

Accessories

No

Boxes per Case

20

Brands

3M™

Case Quantity

20/case

Clip-on Welding Shield

No

Compatible with 3M™ PAPR Systems

No

Compatible with 3M™ Supplied Air System

No

Compatible with Welding Shield

Yes

Cool Flow™ Exhalation Valve

Yes

3M™ Comfort Cradle Head Harness Attachment FF-400-06, 5 EA/Case

3M Product Number FF-400-06 3M ID 7000052737 UPC 50051135894786

Details

Replacement part to use with 3M Ultimate FX Full Facepiece Reusable Respirators FF-401, FF-402, and FF-403 (sold separately)
Designed for use with the 3M Ultimate FX Full Facepiece Reusable Respirators (sold separately)
Maintains original performance standards of facepiece
Lightweight frame weighs only .8 ounces
Replaceable part can potentially result in respiratory equipment cost savings

Typical properties

Accessories
Yes
Boxes per Case
5
Brands
3M™
Case Quantity
5/case
Clip-on Welding Shield
No
Compatible Respirator
FF-400 Series
Compatible with 3M™ PAPR Systems
No
Compatible with 3M™ Supplied Air System
Yes
Compatible with Welding Shield

3M™ Head Strap/Harness Assembly 7893S, Silicone, 2 EA/Case

3M Product Number 7893S 3M ID 7000051828 UPC 50051138213409

Details

Approved 3M replacement part
Six point head suspension for 3M Full Facepiece 7800 Series (sold separately)
Silicone construction for comfort and durability
Replacement part can extend respiratory equipment service life
Replaceable part can potentially result in respiratory equipment cost savings

Typical properties

Accessories
No
Boxes per Case
2
Brands
3M™
Case Quantity
2/case
Clip-on Welding Shield
No
Compatible with 3M™ PAPR Systems
No
Compatible with 3M™ Supplied Air System
No
Compatible with Welding Shield
No
Cool Flow™ Exhalation Valve
No
Dro

3M™ No Touch™ Probed Test Plugs, 393-2013-50, 50/PR

3M Product Number 393-2013-50 3M ID 7100033339 UPC 10093045937483

Details

Test Probe for No Touch™ earplugs

50 pair per case

3M PSD products are for occupational use only

*The NRR may overestimate the hearing protection provided during typical use

Typical properties

Brands

3M™

Product Color

Purple

Product Series

E-A-Rfit

Product Type

Probed Test Earplug

Recommended Application

Health & Safety Testing

eClass 14 Classification Group

40270102

3M™ Scotchlite™ Reflective Material 9586 Series

Details

Compliant brightness designed for enhancing visibility of wearer in low light and nighttime conditions
Certified to major flame-resistance standards
Fluorescent properties help ensure high visibility in daylight, dawn, and dusk
Sew-on application
Printed with 3M trademarks for easy identification

Typical properties

Adhesive
None
Attachment Type
Sew On
Backing
None
Backing Material
Aramid
Brands
Scotchlite™
Certified Performance Required
CGSB, NFPA
Daytime Color
Orange/Silver
Dry-Cleaning Cycles at ANSI Certified Standards
30
Flame Resistant
Yes
Hom

Dimensions and Classifications

Overall Length (Imperial)
109.36 yd
Overall Length (Metric)
100 m
Overall Width (Imperial)
2 in, 3 in
Overall Width (Metric)
50.8 mm, 76.2 mm

3M™ E-A-R™ EXPRESS™ Pod Plugs™ Earplugs 321-2100, Uncorded, Blue Grips, Pillow Pack, 400 Pair/Case

3M Product Number 321-2100 3M ID 7000127178 UPC 10080529210002

Details

Reusable Pillow Pack helps keep earplugs clean when they are not being worn
All Blue Grips - Yellow Foam
Noise Reduction Rating (NRR)* 25 dB. CSA Class AL
Test compatible with 3M™ E-A-Rfit™ Validation System

Typical properties

Attenuation Rating
25.0 Decibel
Banded
No
Brands
E-A-R™
Case Quantity
400
Cord Type
None
Corded
No
Dielectric
No
Dispenser Available
No
Earplug Color
Yellow
Earplug Material
Foam/Thermoplastic
Earplug Shape
Round
Earplug Size
Regula

3M™ E-A-R™ EXPRESS™ Pod Plugs™ Earplugs 311-1114, Corded, Blue Grips, Pillow Pack, 400 Pair/Case

3M Product Number 311-1114 3M ID 7000002309 UPC 10080529110104

Details

Paddle-style grips provide quick, clean, and consistent placement of earplugs
No-roll design keeps earplugs, and ears clean, even when fingers or gloves are dirty
Earplug design keeps tip clean even if hands are dirty
Slow recovery foam easily goes into earcanal and then seats and stays in place
Noise reduction rating (NRR) 25 dB CSA Class AL

Typical properties

Attenuation Rating
25.0 Decibel
Banded
No
Brands
E-A-R™
Case Quantity
400
Cord Color
Blue
Cord Material
Vinyl
Cord Type
Vinyl
Corded
Yes
Dielectric
No
Dispenser Available
No
Earplug Color
Yellow/Blue
Earplug Material
Foam/Thermoplas

3M™ E-A-R™ EXPRESS™ Pod Plugs™ Earplugs 311-1115, Corded, Assorted Color Grips, Pillow Pack, 400 Pair/Case

3M Product Number 311-1115 3M ID 7000127179 UPC 10080529110111

Details

Paddle-style grips provide quick, clean, and consistent placement of earplugs
No-roll design keeps earplugs, and ears clean, even when fingers or gloves are dirty
Earplug design keeps tip clean even if hands are dirty
Slow recovery foam easily goes into ear canal and then seats and stays in place
Cord allows earplugs to be stored conveniently around the neck in between uses
Noise reduction rating (NRR) 25 dB CSA Class AL

Typical properties

Attenuation Rating
25.0 Decibel
Banded
No
Brands
E-A-R™
Case Quantity
400
Cord Color
Blue
Cord Type
Vinyl
Corded
Yes
Dielectric
No
Dispenser Available
No
Earplug Color
Yellow
Earplug Material
Foam/Thermoplastic
Earplug Shape
Round

3M™ E-A-R™ EXPRESS™ Pod Plugs™ Earplugs 321-2200, Uncorded, Assorted Color Grips, Pillow Pack, 400 Pair/Case

3M Product Number 321-2200 3M ID 7000002308

Details

Paddle-style grips make fitting easier than ever
No-roll design helps keep earplugs and ears clean even if hands are dirty
Slow recovery foam inserts easily then seals the earcanal for comfortable hearing protection
Assorted Color Grips - Yellow Foam
Noise reduction rating (NRR) 25 dB CSA Class AL
Reusable Pillow Pack helps keep earplugs clean when they are not being worn

Typical properties

Attenuation Rating
25.0 Decibel
Banded
No
Brands
E-A-R™
Case Quantity
400
Cord Type
None
Corded
No
Dielectric
No
Dispenser Available
No
Earplug Color
Yellow
Earplug Material
Foam/Thermoplastic
Earplug Shape
Round
Earplug Size
Regula

3M™ E-A-R™ EXPRESS™ Pod Plugs™ Earplugs 311-1127, Metal Detectable, Corded, Pillow Pack, 400 Pair/Case

3M Product Number 311-1127 3M ID 7000127208 UPC 10080529110524

Details

Implanted stainless steel ball bearings aid in locating lost earplugs
Designed for food processing and other industries where it is critical to keep earplugs from contaminating products and processes
Paddle-style grips provide quick, clean, and consistent placement of earplugs
No-roll design keeps fingers, earplugs, and ears clean
Noise reduction rating (NRR) 26 dB CSA Class AL
Test compatible with 3M™ E-A-Rfit™ Validation System

Typical properties

Attenuation Rating
26.0 Decibel
Banded
No
Brands
E-A-R™
Case Quantity
400
Cord Color
Blue
Cord Material
Vinyl
Cord Type
Vinyl
Corded
Yes
Dielectric
No
Dispenser Available
No
Earplug Color
Yellow/Blue
Earplug Material
Foam/Thermoplas

3M™ PELTOR™ Throat Microphone MT90, 1 ea/cs

3M Product Number MT90 3M ID 7000127275 UPC 00093045979219

Details

Throat microphone for use on the 3M™ PELTOR™ COMTAC™ III
Communication Headsets

Can be used as an alternative to the boom microphone

A practical solution when boom microphones are ineffective or can't be used,
such as when wearing other personal protective equipment or headborne objects

Picks up vibrations from user's voice box for voice transmission

Effective in noisy environments

Offers stretchable strap with adjustments for different neck sizes

Plugs into the same auxiliary port as the flexible boom mic

Typical properties

Brands

PELTOR™

Microphone Class/Type

Dynamic

Plug Type

J22

Product Color

Black

Product Type

Microphone

Purpose

Exclude

eClass 14 Classification Group

40270191

3M™ PELTOR™ Lite-Com Pro II Dynamic Throat Microphone MT90-02, 1 EA/Case

3M Product Number MT90-02 3M ID 7000040037 UPC 04046719397938

Details

Throat microphone for use on 3M™ PELTOR™ Communication Headsets that feature an dynamic microphone
Can be used as an alternative to the boom microphone
A practical solution when boom microphones are ineffective or can't be used, such as when wearing other personal protective equipment or headborne objects
Picks up vibrations from user's voice box for voice transmission
Effective in noisy environments
Offers stretchable strap with adjustments for different neck sizes
Plugs into the same auxiliary port as the boom mic

Typical properties

Brands
PELTOR™
Microphone Class/Type
Dynamic
Plug Type
J22
Product Color
Black
Product Type
Microphone
Recommended Industry
Agriculture
eClass 14 Classification Group
40270191

3M™ PELTOR™ Earplug Connecting Cord, TEP-CORD, 5 EA/Case

3M Product Number TEP-CORD 3M ID 7100074090 UPC 00093045937837

Details

For use with the 3M™ PELTOR™ electronic earplugs: TEP, LEP, and EEP
Optional earplug cord can be attached to earplug for additional security

Typical properties

Brands

PELTOR™

Case Quantity

1

Product Color

Black

Product Type

Cord

Recommended Application

Law Enforcement, Military, Tactical

Recommended Industry

Hunting, Law Enforcement, Military Maintenance, Repair & Operation (MRO),

Shooting

Tactical C

3M™ PELTOR™ Classics™ Replacement Tips 420-2097-50, Yellow, 50 EA/Case

3M Product Number 420-2097-50 3M ID 7000128157 UPC 10093045935496

Details

Replacement tips fit any 3M™ Peltor™ ORA TAC in-ear communications headset

Yellow Classics™ color provides high visibility in a variety of settings

50 pairs per case provides a lasting supply at a good value

Typical properties

Brands

PELTOR™

Product Type

Replacement Tip

Purpose

Exclude

Specifications Met

CE Approved

eClass 14 Classification Group

40270191

3M™ Secure Click™ Full Facepiece Reusable Respirator FF-801, Small, 4 EA/Case

Part Number FF-801 3M Product Number FF-801 3M ID 7100261327

Details

The quick, easy, one-touch positive pressure push button seal check helps provide improved confidence in respirator fit

Two dual-flow cartridges on each respirator combine to create the world's first quad flow cartridge systems with four airflow paths providing easy breathing and comfort

Large lens for excellent field of vision, and treated with Scotchgard™ Protector for improved paint and stain resistance

Six-strap harness helps provide a secure comfortable fit

Speaking diaphragm is designed to help provide easy communication

The FF-800 Series meets the requirements of ANSI Z87.1-2015 standard for eye and face protection

NIOSH, a Federal government regulatory agency, has tested and approved the FF-800 with 3M Secure Click cartridges and filters

Recommended applications include assembly, chemical clean-up, chemical handling, chipping, chiseling, cleaning, furnace operations, grinding, machining, masonry, painting, pouring/casting, sanding and sawing

Typical properties

Accessories

Yes

Assigned Protection Factor

50 Quantitative Fit Test

Brands

Secure Click™

Cartridge or Filter Included

No

Case Quantity

4

Clip-on Welding Shield

No

Compatible with 3M™ PAPR Systems

No

Compatible with 3M™ Supplied Air System

N

3M™ PELTOR™ Replacement Headset PIC-100HD, 20 ea/Case

3M Product Number PIC-100HD 3M ID 7100262876 UPC 00638060433096

Details

Features an in-ear speech microphone and is not dependent upon a boom microphone near the mouth to detect speech

The PIC-100 replacement headset is compatible with a wide range of personal protective equipment, including respirators

Typical properties

Brands

PELTOR™

Case Quantity

20

Compatible With

PIC-100 Communication Headset

Product Color

Black

Product Type

Communication Headset

eClass 14 Classification Group

40270191

3M™ DBI-SALA® Permanent Multi-Span Horizontal Lifeline System

Details

Available in galvanized and stainless steel 3/8 in. (9.5 mm) 7x19
Available in multiple lengths with many system components
Off the shelf permanent multi-span horizontal system designed for user installation
Metal energy absorber limits fall arrest forces
Flexible system capacity
Equipped with RFID
Sleeve provides hands-free operation (order model 7608002 separately)
Customizable multi-span configurations
Customizable multi-span configurations

Typical properties

Case Quantity
1
Connected Safety ID Equipped
Yes
Install Type
Permanent
Lifeline Length (Imperial)
20 ft, 40 ft, 60 ft
Lifeline Length (Metric)
6.09 m, 12.19 m, 18.28 m
Lifeline Material
Galvanized Cable, Stainless Steel Cable
Maximum Number o

Dimensions and Classifications

Overall Length (Imperial)
20 ft, 40 ft, 60 ft
Overall Length (Metric)
12.2 m, 18.3 m

3M™ DBI-Sala® Assisted Rescue Tool 3500100 for Ultra-Lok™, fork

3M Product Number 3500100 3M ID 7100208217 UPC 00840779002047

Details

Hardware kit for sloped high speed Rollgliss™ Descender
Suspension bars connect descender to guide cable
Braking trolley with snap hook for more control during descent
Designed to be compact and lightweight
Corrosion-resistant steel construction
Recommended for use in construction, oil and gas, and general industrial applications
11.2 lb. (5.1 kg)

Typical properties

Brands
Ultra-Lok™
Case Quantity
1
Connected Safety ID Equipped
No
Descent Type
Vertical
Maximum Number of Users
One
Product Color
Silver
Product Series
Rollgliss™
Product Type
Assisted Rescue Tool
Recommended Industry
Construction, Genera

3M™ DBI-SALA® Rollgliss™ Sloped High Speed Automatic Descender Hardware Kit 3302976, Stainless Steel Hook

Part Number 3302976 3M Product Number 3302976 3M ID 7012818831

Details

Hardware kit for sloped high speed Rollgliss™ Descender
Suspension bars connect descender to guide cable
Braking trolley with snap hook for more control during descent
Designed to be compact and lightweight
Corrosion-resistant steel construction
Recommended for use in construction, oil and gas, and general industrial applications
11.2 lb. (5.1 kg)

Typical properties

Brands
DBI-SALA®
Case Quantity
1
CoWorker Controlled Ascent
No
CoWorker Controlled Descent
No
Connected Safety ID Equipped
No
Descent Type
Vertical
Maximum Number of Users
One
Product Color
Silver
Product Series
Rollgliss™
Product Type

3M™ DBI-SALA® Rollgliss™ Sloped High Speed Automatic Descender Hardware Kit 3302977, Galvanized Steel Hook

Part Number 3302977 3M Product Number 3302977 3M ID 7012818832

Details

Hardware kit for sloped high speed Rollgliss™ Descender
Suspension bars connect descender to guide cable
Braking trolley with snap hook for more control during descent
Designed to be compact and lightweight
Corrosion-resistant steel construction
Recommended for use in construction, oil and gas, and general industrial applications
11.2 lb. (5.1 kg)

Typical properties

Brands
DBI-SALA®
Case Quantity
1
CoWorker Controlled Ascent
No
CoWorker Controlled Descent
No
Connected Safety ID Equipped
No
Descent Type
Vertical
Maximum Number of Users
One
Net Weight (Imperial)
11.2 lb
Net Weight (Metric)
5.1 kg
Prod

3M™ DBI-SALA® Edge Protector Bracket, Wind Energy Descent, 3320003

Part Number 3320003 3M Product Number 3320003 3M ID 7100224718

Details

Hardware kit for sloped high speed Rollgliss™ Descender
Suspension bars connect descender to guide cable
Braking trolley with snap hook for more control during descent
Designed to be compact and lightweight
Corrosion-resistant steel construction
Recommended for use in construction, oil and gas, and general industrial applications
11.2 lb. (5.1 kg)

Typical properties

Brands
DBI-SALA®
Descent Type
None
Maximum Number of Users
N/A
Product Series
Rollgliss™
Product Type
Replacement Parts & Accessories

3M™ DBI-SALA® Aluminum Rope Pulley for Rollgliss™ 9504733

Part Number 9504733 3M Product Number 9504733 3M ID 7100309558

Details

Hardware kit for sloped high speed Rollgliss™ Descender
Suspension bars connect descender to guide cable
Braking trolley with snap hook for more control during descent
Designed to be compact and lightweight
Corrosion-resistant steel construction
Recommended for use in construction, oil and gas, and general industrial applications
11.2 lb. (5.1 kg)

Typical properties

Brands
DBI-SALA®
For Use With
Rescue & Descent Devices
Product Series
Rollgliss™
Product Type
Pulley

3M™ Speedglas™ Heavy-Duty Welding Helmet G5-01 w 3M™ V-100 Vortex™ Cooling Valve Assembly, ADF VC, 46-5702-30iVC, 1 EA/Case

3M ID 7100259402 UPC 00638060433348

Details

Complete Supplied Air (SA) Respiratory Assembly with Speedglas™ G5-01 Heavy-Duty Welding Helmet
Contains the Vortex air-cooling valve, versatile Versaflo™ Premium Belt Holder, rugged leather belt, breathing tube, and complete 3M™ Speedglas™ G5-01 helmet assembly
Provides High-Efficiency particulate respiratory protection
Lightweight, compact design
Ergonomic, adjustable head suspension
Flip front welding shield allows for a clear, wide-view protective visor for grinding and setup
Lightweight belt-mounted valve permits welders to lower the temperature of air entering headpiece by up to 50°F; designed for hot, strenuous jobs
G5 Series storage/carry bag included

Typical properties

ADF Model
G5-01VC
Air Source
SAR
Battery Life
Turbo: approx. 7 - 9 Hours
Battery Type
Turbo: Lithium-ion
Brands
Speedglas™
Breathing Tube Grade
Heavy Duty
Cartridge or Filter Included
HE Filter
Case Quantity
1 EA/Case
Comes with Auto-Darke

3M™ PAPR Shrouds

Details

NIOSH approved when used as part of a complete system
Replacement part

Typical properties

Brands

3M™

Case Quantity

1

Compatible With

3M™ Versaflo™ M-407 Helmet

Flame Resistance (ASTM D2859-96)

No, Yes

High Heat

No, Yes

Material

Leather, Nomex, Nylon, Polypropylene Coated Non-woven Polypropylene,
Polyurethane Coated Knitted Polyamide

Dimensions and Classifications

Overall Height (Imperial)

12 in

Overall Height (Metric)

304.8 mm

Overall Width (Imperial)

18 in

Overall Width (Metric)

457.2 mm

3M™ DBI-SALA® Rollgliss™ Rescue Pick-Off Strap

3M ID B00032535

Details

- Pick-off strap has a 6:1 mechanical advantage
- Available with lightweight, strong polyester webbing or Kevlar® fiber webbing
- Used with technical rope rescue systems
- Leveraged lifting handle
- Adjustable length
- Compact and lightweight design
- Swivel ring adjuster
- Recommended for use in construction, mining, oil and gas, transportation, utilities, wind energy, and general industrial applications
- Meets the requirements of NFPA 1983 (2012) G

Typical properties

- eClass 14 Classification Group
- 15310100

3M™ Virtua™ Sport CCS Protective Eyewear

Details

The Cord Control System (CCS) is designed to help keep eyewear and earplugs attached, untangled, and ready to use
Wraparound design provides extended eye protection and unobstructed viewing
Contoured temples offer a snug fit
U6 rated polycarbonate lenses absorb 99.9% of UVA, UVB, and UVC rays between 200 nm and 380 nm
Meets the Impact-Rated Protector requirement of the ANSI-ISEA Z87.1-2020 Standard
Readers available in +1.5, +2.0, and +2.5 diopters
Optional foam gasket available

Typical properties

ANSI Requirements
ANSI Z87.1-2003 and CSA Z94.3-2007
Anti Fog Lens
Yes
Case Quantity
20
Class
Economy
Comfort Features
Contains foam gasket attachment, Cord Control System Temples for Earplug Attachment, Lightweight, Wraparound lens
Diopter
0

Dimensions and Classifications

Overall Height (Imperial)
6 in
Overall Height (Metric)
15.24 cm
Overall Length (Imperial)
6 in
Overall Length (Metric)
15.24 cm
Overall Width (Imperial)
2 in
Overall Width (Metric)
5.08 cm

3M™ Nuvo™ Protective Eyewear 11411-00000-20, Clear Anti-Fog Lens, Grey Frame, 20 ea/Case

3M ID 7000127497 UPC 10078371620599

Details

“Retro” styling gives the glasses a nostalgic look
Integral brow bar and side shields offer additional protection
Dual lens profile in a one-piece lens design combines style with durability
Soft nose bridge cushions a high contact point
Polycarbonate lenses absorb 99.9% UV

Typical properties

Anti Fog Lens

Yes

Brands

Nuvo™

Case Quantity

20

Class

Value

Comfort Features

Adjustable length temples, Integral sideshields and brow bar, Soft adjustable nose bridge

Eyewear Range

Value

Frame Color

Gray

Frame Material

Plastic

Frame Style

3M™ Safety Eyewear 90212-HZ4, Gray Frame Yellow Accent, Clr/AF & Scratch Resistant Lens, 4/cs

3M ID 70006984820 UPC 00638060081389

Details

Durable lenses help provide limited protection from light to moderate impact hazards

Lightweight, durable design for comfort and lasting use

Scratch-resistant lenses help keep vision clear

Impact-resistant lenses block 99.9% of UV rays

Includes a handy storage bag and lanyard to help prevent damage and loss

Meets the requirements of ANSI Z87.1, CSA Z94.3 and AS/NZS 1337

Typical properties

Brands

3M™

Catalog Number

90212-HZ4

Factory ISO Certification

No ISO Certification information available

Frame Material

Polycarbonate

Frame Style

Wraparound

Sealed Eyewear

No

Splash Protection

No

Standards and Specifications

ANSI Z87.1

Tem

Dimensions and Classifications

Overall Height (Imperial)

6 in

Overall Height (Metric)

152.4 mm

Overall Length (Imperial)

2.5 in

Overall Length (Metric)

63.5 mm

Overall Width (Imperial)

8 in

Overall Width (Metric)

203.2 mm

3M™ Performance Eyewear Dual-Lens Contoured Frame, Black frame with Gray Accents, Mirrored Lens

3M ID 70006984838 UPC 00638060081396

Details

Durable lenses help provide limited protection from light to moderate impact hazards

Lightweight, durable design for comfort and lasting use

Scratch-resistant lenses help keep vision clear

Impact-resistant lenses block 99.9% of UV rays

Includes a handy storage bag and lanyard to help prevent damage and loss

Meets the requirements of ANSI Z87.1, CSA Z94.3 and AS/NZS 1337

Indoor/outdoor mirrored lenses help reduce glare and are popular for inside and outside environments

Typical properties

Brands

3M™

Catalog Number

90213-HZ4-NA

Factory ISO Certification

No ISO Certification information available

Frame Material

Polycarbonate

Frame Style

Wraparound

Sealed Eyewear

No

Splash Protection

No

Standards and Specifications

AS/NZS 1337

Dimensions and Classifications

Overall Height (Imperial)

6 in

Overall Height (Metric)

152.4 mm

Overall Length (Imperial)

2.5 in

Overall Length (Metric)

63.5 mm

Overall Width (Imperial)

8 in

Overall Width (Metric)

203.2 mm

3M™ Safety Eyewear Soft Rubber Nose and Ear Pieces for Comfort, Black Frame with Yellow Accent, Clear lens

3M ID 70006984796 UPC 00638060081358

Details

Durable Lenses Help Provide Limited Protection From Light To Moderate Impact Hazards

Contoured Design

Lightweight – Weighs Less Than 1 Ounce

Scratch-Resistant Coating Helps Keep Vision Clear

Impact-resistant lenses block 99.9% of UV rays

Meets the requirements of ANSI Z87.1

Clear lenses help provide excellent visibility and can be used indoors or outdoors

Lens color: Clear

Quantity: 1

Typical properties

Brands

3M™

Catalog Number

90209-HV6-NA

Factory ISO Certification

No ISO Certification information available

eClass 14 Classification Group

40230101

3M™ Safety Eyewear Soft Rubber Nose and Ear Pieces for Comfort, Black Frame with Yellow Accent, Gray Lens

3M ID 70006984804 UPC 00638060081365

Details

Durable Lenses Help Provide Limited Protection From Light To Moderate Impact Hazards

Contoured Design

Lightweight – Weighs Less Than 1 Ounce

Scratch-Resistant Coating Helps Keep Vision Clear

Impact-resistant lenses block 99.9% of UV rays

Meets the requirements of ANSI Z87.1

Gray lenses help reduce sunlight and are popular for outdoor use

Typical properties

Brands

3M™

Catalog Number

90210-HV6-NA

Factory ISO Certification

No ISO Certification information available

eClass 14 Classification Group

40230101

3M™ DBI-SALA® Confined Space Winch with Power Drive Option

Details

- 9:1 and 4:1 gear ratio mechanical advantage
- Incorporated mounting bracket allows for attachment to 3M DBI SALA tripods and davits
- Built-in digital usage indicator
- Triple redundant braking system and brake wear indicator
- Bearings sealed at all contact points
- Swiveling snap hook includes impact indicator
- Drill-enabled Power drive option allows for more efficient retrieval available with select models
- Recommended for use in many industries
- Power Drive Option Available on select skus

Typical properties

- Cable Length (Imperial)
59.055 ft, 60 ft, 88.583 ft, 137.795 ft, 140 ft
- Cable Length (Metric)
18 m, 18.288 m, 27 m, 42 m, 42.672 m
- Cable Material
Galvanized Steel, Stainless Steel, Technora Rope
- Carabiner/Hook Material
Zinc Plated Steel
- Case Quant

Dimensions and Classifications

- Overall Length (Imperial)
18 ft, 60 ft, 90 ft, 140 ft, 190 ft, 240 ft, 290 ft
- Overall Length (Metric)
18 m, 18.288 m, 27 m, 42 m, 58 m, 73 m, 88 m, 347.98 mm

3M™ PROTECTA® Compliance in a Can™ Roofer's Fall Protection Kit

3M ID B00035926

Details

Complete personal fall arrest system designed for at height applications
Versatile Protecta® P50™ harness features pass-thru buckle legs and 5-point adjustment design
Reusable anchorage device or tie-off adapter conveniently secures connecting device
Compact rope adjuster with built-in PRO™ shock-absorbing lanyard or Rebel™ self-retracting lifeline help reduce fall arrest forces
Kits equipped with lanyards feature a blended lifeline with snap hook that measures 50 ft
Includes equipment storage bucket with handle for easy transport
Durable materials and hardware stand up to harsh working conditions
Meets the requirements of OSHA 1910.140 and OSHA 1926.502
Recommended for use in the construction industry

Typical properties

eClass 14 Classification Group
15310100

DBI-SALA SecuraSpan I-Beam Horizontal Lifeline System

3M ID B00036514

Details

- Rugged 3/8" (9.5mm) 7x19 galvanized cable lifeline
- Fits I-beam flanges 6 in. to 12 in. (15.2-30.5 cm) up to 2-1/4" (5.7 cm) thick
- Lightweight and portable design
- Top mounted adjustment system
- Simple clamp and wing nut installation
- Extremely durable construction
- Single and multi-span indefinite length system configurations
- Pass-thru 100% tie-off protection
- Flexible system capacity
- Stanchion is offset 15 degrees for easy passage
- Various lengths and individual components are available
- Equipped with 3M™ Connected Safety ID (CSID)

3M™ DBI-SALA® Confined Space Aluminum Ladder Section 8518508, 4 ft

Part Number 8518508 3M Product Number 8518508 3M ID 7012820787

Details

Aluminum ladder
Built-in connector channels and pin locks
Connect up to 5 sections together
Lightweight, durable aluminum construction
Bracket available to attach ladder to confined space system (model 8518506)

Typical properties

Brands
DBI-SALA®
Case Quantity
1
Connected Safety ID Equipped
No
Dimensions
13.00x2.50x55.00in
Net Weight (Imperial)
9.8 lb
Product Color
Silver
Recommended Industry
Construction, General Industrial, Mining, Oil & Gas, Transportation, Utiliti

Dimensions and Classifications

Overall Length (Imperial)
4 ft

3M™ Speedglas™ G5-03 Pro-Air Welding Helmet 45-0099-33, No Headband, No ADF, 1 EA/Case

3M Product Number 45-0099-33 3M ID 7100312616 UPC 00076308401795

Details

Robust, compact design
Ergonomic, adjustable head suspension
GRIND and CUT mode functionality, when using G5 auto darkening filters
Available in two different Auto-Darkening Lens options (VC/TW)
Compatible with multiple accessories
Suitable for most types of arc welding

Typical properties

Air Source
PAPR/SAR
Brands
Speedglas™
Case Quantity
1
Comes with Auto-Darkening Filter (ADF)
No
Compatible Respirator
Adflo, TR-300 Series, TR-600 Series
Headgear Type
Welding Helmet
Lens Type
No Lens
Product Series
G5
Recommended Industry

3M™ Speedglas™ G5-03 Pro-Air Welding Helmet 45-0099-35, No ADF, 1 EA/Case

3M Product Number 45-0099-35 3M ID 7100306444 UPC 00638060430507

Details

Robust, compact design
Ergonomic, adjustable head suspension
GRIND and CUT mode functionality, when using G5 auto darkening filters
Available in two different Auto-Darkening Lens options (VC/TW)
Compatible with multiple accessories
Suitable for most types of arc welding

Typical properties

Air Source
PAPR/SAR
Brands
Speedglas™
Case Quantity
1
Comes with Auto-Darkening Filter (ADF)
No
Compatible Respirator
Adflo, TR-300 Series, TR-600 Series
Headgear Type
Welding Helmet
Lens Type
No Lens
Product Series
G5
Recommended Applicat

3M™ Versaflo™ Size Reducing Comfort Pad for Premium Head Suspension S-954, 20 EA/Case

3M Product Number S-954 3M ID 7100010371 UPC 50051131373063

Details

May make S-950 Premium Head Suspension more comfortable for smaller wearers

Typical properties

Brands
Versaflo™
Compatible With
3M™ Premium Head Suspension, S-950
Headgear Type
Head Suspension
High Heat
No
Product Color
Black
Product Series
S-Series
Product Type
Comfort Pad
Recommended Industry
Marine

3M™ Versaflo™ Comfort Pad for Premium Head Suspension, S-953, 20 EA/Case

3M Product Number S-953 3M ID 7000127438 UPC 50051131373056

Details

For use with S-950 Premium Head Suspension
Helps create a more comfortable fit and absorbs sweat

Typical properties

Brands
Versaflo™
Compatible With
3M™ Premium Head Suspension, S-950
Headgear Type
Head Suspension
High Heat
No
Product Color
Gray
Product Series
S-Series
Product Type
Comfort Pad
Recommended Industry
Marine

3M™ Versaflo™ Size Reducing Ratchet Comfort Pad M-956/37327(AAD), 10 EA/Case

3M Product Number M-956 3M ID 7000127693 UPC 50051131373278

Details

For use on all 3M™ Versaflo™ M-Series helmets
Attaches to ratchet on back of helmet

Typical properties

Brands
Versaflo™
Case Quantity
10
Compatible With
3M™ Versaflo™ M-Series Headgear
Headgear Type
Headcover
High Heat
No
Product Color
Black
Product Series
M-Series
Product Type
Comfort Pad
Recommended Industry
Marine

3M™ Speedglas™ G5-03 Welding Helmet Powered Air System

Details

Robust, compact design
Ergonomic, adjustable head suspension
GRIND and CUT mode functionality, when using G5 auto darkening filters
Available in two different Auto-Darkening Lens options (VC/TW)

Typical properties

ADF Model
G5-01/03TW, G5-01/03VC, G5TW, G5VC, None
ADF Technology
Natural Color, TAP, Tack Weld Mode, Variable Color
Air Source
PAPR
Assigned Protection Factor
25
Battery Type
ADF: Lithium 3V (CR2450), PAPR: Lithium ion, Turbo: Lithium-ion, Turbo

3M™ E-A-Rfit™ Dual-Ear 1/4-20 to 5/8-27 Speaker Stand Adaptor 073-096

3M Product Number 073-096 3M ID 7100077868 UPC 00078371670153

Details

Speaker stand adapter for use with 3M™ E-A-Rfit™ Dual-Ear Validation System Adapter has 5/8" end to attach to black speaker stand and 1/4" end to screw into bottom of speaker

3M PSD products are for occupational use only

NOTE: 3M strongly recommends fit testing of hearing protectors. Research suggests that many users will receive less noise reduction than indicated by the NRR due to variation in hearing protector fit, fitting skill and motivation of the user. If the NRR is used, 3M recommends that it be reduced by 50% or in accordance with applicable regulations

Typical properties

Brands

E-A-R™

Case Quantity

1

Product Type

Adapter

Recommended Application

Health & Safety Testing

Recommended Industry

Automotive, General Manufacturing, Metal Fabrication, Military Maintenance, Repair & Operation (MRO), Mining, Oil & Gas, Pharm

3M™ Dual Airline Front-Mounted Adapter Kit SA-1000LP, Low Pressure 1 EA/Case

3M Product Number SA-1000LP 3M ID 7000126159 UPC 00051138462710

Details

This kit, with facepiece, filters/cartridges and air hose, makes a 3M™ Dual Airline Supplied Air Respirator

Typical properties

Brands

3M™

Breathing Tube Type

Front-Mounted

CFM Capacity per Minute

100 CFM, 50 CFM

Cartridge or Filter Included

No

Case Quantity

1/case

Coupling Size

0.25" MPT, 3/8" Body Size, Industrial Interchange

Fitting Type

Industrial Interchange

Hos

3M™ Combination Dual Airline Back-Mounted Adapter Kit SA-2100LP, Low Pressure, 1 EA/Case

3M Product Number SA-2100LP 3M ID 7000126198 UPC 00051138542436

Details

Works with certain 3M™ Full face piece respirators

Typical properties

Brands

3M™

Breathing Tube Type

Back-Mounted Combination

CFM Capacity per Minute

100 CFM, 50 CFM

Cartridge or Filter Included

No

Case Quantity

1/case

Coupling Size

0.25" MPT, 3/8" Body Size, Industrial Interchange

Fitting Type

Industrial Inter

3M™ Combination Dual Airline Back-Mounted Adapter Kit SA-2100, High Pressure, 1 EA/Case

3M Product Number SA-2100 3M ID 7000052039 UPC 00051138542429

Typical properties

Brands

3M™

Breathing Tube Type

Back-Mounted Combination

CFM Capacity per Minute

100 CFM, 50 CFM

CFM Capacity per Minute (Metric)

113 to 425 litres per min

Cartridge or Filter Included

No

Case Quantity

1/case

Compatible With

3M™ Supplied Air S

3M™ Dual Airline Front-Mounted Adapter Kit SA-1000 1 EA/Case

3M Product Number SA-1000 3M ID 7000126158 UPC 00051138462703

Details

This kit, with facepiece, filters/cartridges and air hose, makes a 3M™ Dual Airline Supplied Air Respirator

Typical properties

Brands

3M™

CFM Capacity per Minute

100 CFM, 50 CFM

Cartridge or Filter Included

No

Case Quantity

1/case

Coupling Size

0.25" MPT, 0.25" Body Size, Industrial Interchange

Fitting Type

Industrial Interchange

Hose Type

Straight

Mounting Type

Fr

3M™ Suspenders TR-329, for Versaflo™ TR-300 & Speedglas™ TR-300-SG PAPR, 1 EA/Case

Part Number 17362 3M Product Number TR-329 3M ID 7100004866

Details

For use with certain 3M Versaflo TR-300 PAPR configurations
May reduce weight of blower unit around the waist

Typical properties

Brands

Versaflo™

Case Quantity

1/pack

Compatible With

3M™ Versaflo™ TR-300 Series PAPR, 3M™ Versaflo™ TR-300N+ Series PAPR

Hazard Type

Silica

Mounting Type

Suspenders

Product Color

Black

Product Series

TR-300, TR-300+

Product Type

Suspender

3M™ Prefilter TR-3600, for Versaflo™ TR-300 PAPR 100 EA/Case

3M Product Number TR-3600 3M ID 7000127713 UPC 50051131173694

Details

May extend life of HE filter by capturing large particles that may clog the filter
For use with the 3M™ Versaflo™ TR-300 PAPR
Discard when clogged or damaged
Genuine 3M™ Accessory

Typical properties

Brands
Versaflo™
Cartridge or Filter Type
Particulate
Compatible Respirator
TR-300 Series
Hazard Type
Silica
NIOSH Cartridge or Filter Assigned Color Coding
Magenta
Product Series
TR-300, TR-300+
Product Type
Filter
Protection Type
Particul

3M™ Organic Vapor Cartridge 07046

Part Number 07046 3M ID 7000002011 UPC 00051131070462

Details

NIOSH approved for protection against certain organic vapors
Swept-back design allows an enhanced field of view and comfort
Bayonet compatibility allows use with many 3M half and full facepiece designs
Wide range of applications reduces inventory needs
Simple installation and usage requirements reduces training requirements

Typical properties

Brands

3M™

Compatible Respirator

3M™ Full Facepieces 6000, 3M™ Full Facepieces 7800 Series, 3M™ Full Facepieces FF-400, 3M™ Half Facepiece Reusable Respirators 6000 Series, 3M™ Half Facepiece Reusable Respirators 6500 Series, 3M™ Half Facepiece Reusable

3M(TM) Replacement Cartridge/Filter Packout 07195, Organic Vapor/P95

Part Number 07195 3M ID 7010341030 UPC 00051131071957

Details

Packaged with 1 pair 07046 organic vapor cartridges and 2 pairs of 07194 P95 filters
swept back cartridge design
Spray paint applications
For occupational use only

Typical properties

Brands

3M™

Compatible Respirator

3M™ Full Facepieces 6000, 3M™ Full Facepieces 7800 Series, 3M™ Full Facepieces FF-400, 3M™ Half Facepiece Reusable Respirators 6000 Series, 3M™ Half Facepiece Reusable Respirators 6500 Series, 3M™ Half Facepiece Reusabl

3M™ Versaflo™ Prefilter TR-6600/37354(AAD), for TR-600 PAPR, 50 EA/Case

Part Number 37354 3M Product Number TR-6600 3M ID 7100021255

Details

May reduce operating costs by extending the life of TR-6000 series filters and cartridges
Easy to use due to simple maintenance free design
Flexible application because TR-6600 may be used with TR-662 spark arrestor
Genuine 3M™ Accessory

Typical properties

Brands
Versaflo™
Cartridge or Filter Type
Particulate
Case Quantity
50
Compatible Respirator
TR-600 Series
Hazard Type
Silica
Intrinsically Safe
Yes
Net Weight (Metric)
1 g
Product Series
TR-600
Product Type
Filter & Pre-filter
Recommend

Dimensions and Classifications

Overall Height (Metric)
0.167 m
Overall Length (Metric)
0.289 m
Overall Width (Metric)
0.226 m

3M™ Bayonet Assembly FF-400-08, 10 EA/Case

3M Product Number FF-400-08 3M ID 7000052739 UPC 50051135894809

Details

Replacement part to use with 3M Ultimate FX Full Facepiece Reusable Respirators FF-401, FF-402, and FF-403 (sold separately)
Designed for use with the 3M Ultimate FX Full Facepiece Reusable Respirators (sold separately)
Maintains original performance standards of facepiece
Assembly includes inhalation valve
Replaceable part can potentially result in respiratory equipment cost savings

Typical properties

Accessories
Yes
Boxes per Case
10
Brands
3M™
Case Quantity
10/case
Clip-on Welding Shield
No
Compatible Respirator
FF-400 Series
Compatible with 3M™ PAPR Systems
No
Compatible with 3M™ Supplied Air System
Yes
Compatible with Welding Shield

3M™ Nose Cup Valve Assembly 7882, Replacement Part 20 EA/Case

3M Product Number 7882 3M ID 7000125976 UPC 50021200603391

Details

Approved 3M replacement part

Recommended for 3M Nose Cup Assembly 7881S

Recommended for 3M Nose Cup Assembly 7981S, Small

Replacement nose cup valve assembly can extend service life of nose cup assembly

Replaceable part can potentially result in respiratory equipment cost savings

Typical properties

Accessories

No

Boxes per Case

20

Brands

3M™

Case Quantity

20/case

Clip-on Welding Shield

No

Compatible with 3M™ PAPR Systems

No

Compatible with 3M™ Supplied Air System

No

Compatible with Welding Shield

No

Cool Flow™ Exhalation Valve

No

D

3M™ Speedglas™ SL Auto-Darkening Filter 05-0000-41, Shade 8-12, 1 EA/Case

3M Product Number 05-0000-41 3M ID 7010384893 UPC 00051131985575

Details

Variable Shades 8-12

1.68" x 3.57" ADF viewing area

Thanks to its motion detector sensor, the welding filter turns on as soon as you grab the helmet and then turns off automatically after fifteen minutes of non use

Typical properties

ADF Dark State Shades

Variable 8-12

ADF Shade Range

Variable 8-12

ADF Viewing Area (Metric)

42x93 mm

ADF Viewing Area (hwxw)

1.68x3.57in

Battery Life

2500 hours

Battery Type

CR2032

Brands

Speedglas™

Case Quantity

1

Dark Shades

Shades 9-13

3M™ Speedglas™ G5-01 Starter Kit, 45-1101-99, 1 EA/Case

3M Product Number 45-1101-99 3M ID 7100214377 UPC 00076308944872

Details

A collection of some of the most common consumables for the 3M™ Speedglas™ Heavy-Duty Welding Helmet G5-01
Replace worn out or damaged parts

Typical properties

Brands

Speedglas™

Compatible Welding Helmet

G5-01 Welding Helmets

Product Color

Black

Product Series

G5

Product Type

Starter Kit

Recommended Application

Grinding, Metal Processing, Metal Repair, Welding

Recommended Industry

General Manufactur

3M™ Welding Sweatbands

Details

For use with 3M™ Helmets and Protective Visors

Original 3M™ Accessory

Replaces worn or unhygienic parts

Helps ensure you get the correct level of comfort

For highest possible safety and comfort, regularly check your equipment for worn or damaged parts

Typically replaced once per month or more often if sweatband becomes unhygienic

Typical properties

Brands

3M™

Case Quantity

2,3

Compatible Welding Helmet

100 Series, 9002NC, G5-01 Welding Helmets, G5-02 Welding Helmets

Features

100 Series Accessory

Headgear Type

Welding Helmet

Material

Fleece

Part Type

Spare Part

Product Series

100, 9002

3M™ Speedglas™ 9100 Series Welding Helmets

Details

Available Auto Darkening Lenses with seven variable dark shades (5, 8 and 9-13) for most types of arc welding
Available in multiple models with various viewing area sizes
Available with or without side windows
Compatible with many 3M™ Safety Spectacles and/or 3M™ Disposable or Reusable Welding Particulate Respirators
Ergonomically-designed head suspension

Typical properties

ADF Model
9100X, 9100XXi, None
ADF Viewing Area (Metric)
54 mm x 107 mm, 73 mm x 107 mm
Battery Life
2500 hours, ADF: up to 1800 Hours
Battery Type
ADF: CR2032, CR2032
Case Quantity
1
Comes with Auto-Darkening Filter (ADF)
No, Yes
Features
Ad

Dimensions and Classifications

ADF Viewing Area (Imperial)
2.1 in x 4.2 in, 2.8 in x 4.2 in

3M™ 334 Series Splash Safety Goggles

Details

Economical safety goggles

Choose from models with direct vent ports for impact protection and indirect vent ports for dust and splash protection

Safety goggles fit over most prescription eyewear

Adjustable elastic strap

Uncoated or anti-fog polycarbonate lens absorbs 99.9% of UV rays

Meets the Impact-Rated Protector requirement of the ANSI-ISEA Z87.1-2020 Standard

Typical properties

Anti Fog Lens

No, Yes

Case Quantity

10

Class

Economy

Comfort Features

Adjustable elastic strap, Fits over most glasses, Indirect ventilation,

Polycarbonate lens, Splash shield

Eyewear Range

Economy

Frame Color

Clear

Frame Style

Goggle

Hard C

3M™ DBI-SALA® Flame Resistant Pass-Thru Web Tie-Off Adapter Anchor 1002207, Kevlar® Fiber, 12 ft

Part Number 1002207 3M Product Number 1002207 3M ID 7012815122

Details

Lightweight and durable polyester web construction
Meets the requirements for 29 CFR OSHA 1910.140, and OSHA 1926.502
Recommended for use in multiple industries including construction, mining, oil and gas, transportation, utilities, and wind energy
Adjustable designs available to accommodate a variety of different sized structures
Compatible with various fall arrest systems
This safety equipment is designed for use with additional personal fall arrest systems
Features high-strength steel hardware
Portable and reusable
Ideal anchorage device for scaffolding or piping

Typical properties

Anchor Install Type
Reusable
Attachment Type
Pass-through/Choker
Brands
DBI-SALA®
Case Quantity
1
Connected Safety ID Equipped
No
Install Type
Reusable
Material
Kevlar®
Product Color
Black
Product Type
Web Tie-Off Adaptor
Recommended Ind

Dimensions and Classifications

Overall Length (Imperial)
12 ft

3M™ DBI-SALA® Pass-Thru Adjustable Web Tie-Off Adapter Anchor 1002130, Polyester, 30 ft

Part Number 1002130 3M Product Number 1002130 3M ID 7012815117

Details

Lightweight and durable polyester web construction
Meets the requirements for 29 CFR OSHA 1910.140, and OSHA 1926.502
Recommended for use in multiple industries including construction, mining, oil and gas, transportation, utilities, and wind energy
Adjustable designs available to accommodate a variety of different sized structures
Compatible with various fall arrest systems
This safety equipment is designed for use with additional personal fall arrest systems
Features high-strength steel hardware
Portable and reusable
Ideal anchorage device for scaffolding or piping

Typical properties

Anchor Install Type
Reusable
Attachment Type
Pass-through/Choker
Brands
DBI-SALA®
Case Quantity
1
Connected Safety ID Equipped
No
Install Type
Reusable
Material
Polyester Web
Product Color
Yellow
Product Type
Web Tie-Off Adaptor
Recommen

Dimensions and Classifications

Overall Length (Imperial)
30 ft

3M™ DBI-SALA® Pass-Thru Adjustable Web Tie-Off Adapter Anchor 1002120, Polyester, 20 ft

Part Number 1002120 3M Product Number 1002120 3M ID 7012815116

Details

Lightweight and durable polyester web construction
Meets the requirements for 29 CFR OSHA 1910.140, and OSHA 1926.502
Recommended for use in multiple industries including construction, mining, oil and gas, transportation, utilities, and wind energy
Adjustable designs available to accommodate a variety of different sized structures
Compatible with various fall arrest systems
This safety equipment is designed for use with additional personal fall arrest systems
Features high-strength steel hardware
Portable and reusable
Ideal anchorage device for scaffolding or piping

Typical properties

Anchor Install Type
Reusable
Attachment Type
Pass-through/Choker
Brands
DBI-SALA®
Case Quantity
1
Connected Safety ID Equipped
No
Install Type
Reusable
Material
Polyester Web
Product Color
Yellow
Product Type
Web Tie-Off Adaptor
Recommen

Dimensions and Classifications

Overall Length (Imperial)
20 ft

3M™ DBI-SALA® Pass-Thru Adjustable Web Tie-Off Adapter Anchor 1002110, Polyester, 10 ft

Part Number 1002110 3M Product Number 1002110 3M ID 7012815113

Details

Lightweight and durable polyester web construction
Meets the requirements for 29 CFR OSHA 1910.140, and OSHA 1926.502
Recommended for use in multiple industries including construction, mining, oil and gas, transportation, utilities, and wind energy
Adjustable designs available to accommodate a variety of different sized structures
Compatible with various fall arrest systems
This safety equipment is designed for use with additional personal fall arrest systems
Features high-strength steel hardware
Portable and reusable
Ideal anchorage device for scaffolding or piping

Typical properties

Anchor Install Type
Reusable
Attachment Type
Pass-through/Choker
Brands
DBI-SALA®
Case Quantity
1
Connected Safety ID Equipped
No
Install Type
Reusable
Material
Polyester Web
Product Color
Yellow
Product Type
Web Tie-Off Adaptor
Recommen

Dimensions and Classifications

Overall Length (Imperial)
10 ft

3M™ DBI-SALA® Confined Space One-Piece Offset Davit Mast

Details

Integrated 5,000 lb. (22 kN) mast anchorage point
Depending on davit base, rated for fall arrest in different davit offset mast positions
Adjustable vertical height
Integrated secondary fall arrest anchorage point
For use with portable and permanent bases
Recommended for use in many industries

Typical properties

Case Quantity
1
Connected Safety ID Equipped
No
Install Type
Portable
Net Weight (Imperial)
31 lb, 40 lb, 43.5 lb, 45 lb, 48 lb, 50 lb
Net Weight (Metric)
14.1 kg, 18 kg, 19.7 kg, 20.4 kg, 21.7 kg, 22.6 kg
Product Color
Green, Silver
Product S

Dimensions and Classifications

Overall Height (Imperial)
89.5 in, 101.5 in, 103.08 in, 113.5 in, 115.08 in, 126.78 in
Overall Height (Metric)
227.33 cm, 257.81 cm, 261.82 cm, 288.29 cm, 292.3 cm, 322.02 cm

3M™ PELTOR™ Lite-Com Pro II Power Supply for IS Battery FR08, 1 EA/Case

3M Product Number FR08 3M ID 7000108521 UPC 07318640063044

Details

Power supply adapter for use with AL2AI and AL2AH charging cables
For charging 3M™ PELTOR™ Batteries
1 EA/Case

Typical properties

Brands
PELTOR™
Product Color
Black
Product Type
Power Supply
eClass 14 Classification Group
40270191

3M™ PELTOR™ ProTac Shooter Headset, Green, Headband

3M Product Number MT13H223A 3M ID 7100088425 UPC 04054596123168

Details

Professional-Quality Hearing Protection (26dB NRR)

Environmental microphones for level-dependent hearing protection and ambient listening

3.5 mm listen-only stereo input for connection to external devices (e.g. cell phone, two-way radio, Ipad)

Voice guided menu system for ease of use and adjusting settings

Auto power off, the headset will turn off after 4 hrs of non-use to save battery

Low-battery warning to inform you when to change batteries

To reduce corrosion caused by sweat and moisture, the electronics are located in a separate compartment of the cup

Typical properties

Attenuation Rating

26 dB

Audio Type

Communication

Auxiliary Port

3.5mm

Battery Life

100 Hours

Bluetooth

No

Brands

PELTOR™

Built In FM and or AM Radio

No

Built in 2-Way Radio

No

Case Quantity

10

Communication Direction

Listen-only

Commu

3M™ Protective Coverall 4545

Details

Constructed from microporous PE laminate material for Type 5 and Type 6 protection

Anti-static treatment can help reduce static build-up

Reinforced gusset between the legs helps provide increased durability while bending and squatting

Knit cuffs provide a soft wrist closure for increased comfort compared to elastic closures

Recommended for use in multiple industries including sewage, hazardous biological aerosol, and more

20 units included in each case

Typical properties

Additional Protection Features

Antistatic Protection, Biological Protection, Radioactive Particulate Protection

Closure Method

Two-way Zipper

Coverall Style

Hooded

Features

3 Panel Hood, Elastic Waist, Enhanced Gusset, Knitted Cuff

Hazard Type

Ce

3M™ Aura™ Particulate Respirator 9205+

3M ID B00051022 UPC 00051131224766

Details

NIOSH APPROVED for at least 95 percent filtration efficiency against certain non-oil based particles

FITS A WIDE RANGE OF FACE SHAPES AND SIZES

CURVED LOW-PROFILE DESIGN conforms well to nose and eye contours, allowing more room for eyewear

EMBOSSSED TOP PANEL designed to help reduce eyewear fogging

INNOVATIVE CHIN TAB designed for ease of positioning, donning and adjustment

3-PANEL DESIGN ACCOMMODATES FACIAL MOVEMENTS to help you work and talk comfortably

SOFT INNER MATERIALS feel comfortable against the skin

ADJUSTABLE NOSECLIP helps provide a custom secure seal

INDIVIDUAL PACKAGING and flat fold design provide convenient storage and portability prior to use

SUGGESTED APPLICATIONS: For grinding, sanding, sweeping, bagging and other dusty or arid operations

HELPS FILTER CERTAIN AIRBORNE PARTICLES including dust & debris, smoke & smog particles, airborne germs, cough & sneeze debris and other particulate matter

COMPATIBLE WITH A VARIETY OF EYEWEAR

Available in 3, 10, and 20 packs

Typical properties

Brands

3M™

Exhalation Valve

No

Factory ISO Certification

No ISO Certification information available

Filter Class

N95

Product Color

White

Registered Medical Device

No

Respirator Size

Standard

Specifications Met

Assigned Protection Factor (AD)

3M™ SecureFit™ Safety Helmet X5001X-ANSI, White, Reflective

3M ID 70007073821 UPC 00051131225169

Details

Patented Pressure Diffusion Technology reduces forehead pressure by 20% on average compared to 3M conventional helmets
Smooth, easy-turning ratchet suspension system sits low on the head for greater comfort and security
Proprietary UV indicator that lets wearer know when to replace helmet due to UV exposure
Chinstrap is designed with quick and smooth adjustment features for custom fit
3M™ Scotchlite™ Reflective Material for enhanced visibility under low light
Works with a variety of 3M visors, faceshields, reflective kits, and other accessories available to help meet specific job requirements
Meets ANSI Z89.1 Type 1 Class G and E
Low-profile brimless design helps with upward visibility and movement around overhead objects
For industrial/occupational use only. Not for consumer sale or use

Typical properties

Brands
SecureFit™
Factory ISO Certification
No ISO Certification information available
eClass 14 Classification Group
40300202

3M™ SecureFit™ Hard Hat Non-Vented Full Brim with Ratchet Adjustment, White, 1 Ea/Pk

3M ID 70007082905 UPC 00051131226746

Details

Patented 3M™ Pressure Diffusion Technology incorporates self-adjusting front paddles along your forehead
Suspension flexes and self-adjusts, reducing forehead pressure and increasing comfort for all-day wear
Smooth-turning 4-point ratchet suspension system for custom, on-head sizing
Suspension sits low on the head to increase comfort and security
Customize your fit with multiple levels of height and head-shape adjustments
Fits hat sizes 6 ¼ to 8 (50 to 64cm head circumference)
Breathable, washable sweatband – to help keep you cool and dry
Full brim model helps protect neck and ears from UV rays
Non-vented hard hat meets ANSI Z89.1/CSA Z94.1 Type I, Class G and E requirements
Made in USA with globally sourced materials

Typical properties

Brands
3M™
Factory ISO Certification
No ISO Certification information available
eClass 14 Classification Group
40300202

3M™ SecureFit™ Hard Hat Non-Vented Cap Style with Ratchet Adjustment, Yellow, 1 Ea/Pk

3M ID 70007082939 UPC 00051131226753

Details

Patented 3M™ Pressure Diffusion Technology incorporates self-adjusting front paddles along your forehead
Suspension flexes and self-adjusts, reducing forehead pressure and increasing comfort for all-day wear
Smooth-turning 4-point ratchet suspension system for custom, on-head sizing
Suspension sits low on the head to increase comfort and security
Customize your fit with multiple levels of height and head-shape adjustments
Fits hat sizes 6 ¼ to 8 (50 to 64cm head circumference)
Breathable, washable sweatband – to help keep you cool and dry
Cap style hard hat is ANSI compliant when worn forward or reverse
Non-vented hard hat meets ANSI Z89.1/CSA Z94.1 Type I, Class G and E requirements
Made in USA with globally sourced materials

Typical properties

Brands
3M™
Factory ISO Certification
No ISO Certification information available
eClass 14 Classification Group
40300202

3M™ SecureFit™ Hard Hat Non-Vented Cap Style with Ratchet Adjustment, White, 1 Ea/Pk

3M ID 70007082681 UPC 00051131226692

Details

Patented 3M™ Pressure Diffusion Technology incorporates self-adjusting front paddles along your forehead

Suspension flexes and self-adjusts, reducing forehead pressure and increasing comfort for all-day wear

Smooth-turning 4-point ratchet suspension system for custom, on-head sizing

Suspension sits low on the head to increase comfort and security

Customize your fit with multiple levels of height and head-shape adjustments

Fits hat sizes 6 ¼ to 8 (50 to 64cm head circumference)

Breathable, washable sweatband – to help keep you cool and dry

Cap style hard hat is ANSI compliant when worn forward or reverse

Non-vented hard hat meets ANSI Z89.1/CSA Z94.1 Type I, Class G and E requirements

Made in USA with globally sourced materials

Typical properties

Brands

3M™

Factory ISO Certification

No ISO Certification information available

eClass 14 Classification Group

40300202

3M™ Cool Flow™ Valve Respirator Paint Protection - Advanced Comfort 7512 (M)

3M ID 70006963048 UPC 00051131527652

Details

NIOSH-APPROVED 6001 OV CARTRIDGE for use against certain organic vapors
NIOSH-APPROVED 5P71 P95 RATED filters for at least 95% filtration efficiency against solids and liquid aerosols, as well as oil-based particulates
FOR WORKPLACE/OCCUPATIONAL USE ONLY
OIL PROOF P-series particulate filter
3M™ COOL FLOW™ VALVE helps direct exhaled breath downward
ADJUSTABLE HEAD STRAPS allow for a personalized fit
KIT CONTENTS: one facepiece, one pair of 6001 cartridges, one pair of 501 retainers and two pairs of 5P71 filters
CONVENIENT, REUSABLE DESIGN
DURABLE DESIGN for lasting wear
LIGHTWEIGHT, SILICONE FACESEAL for premium comfort
3M™ BAYONET CONNECTION compatible with 3M™ cartridges and filters
VALVE COVER DESIGN directs exhaled breath downward
SMOOTH SURFACE for quick & easy cleaning
6001 OV CARTRIDGE HELPS REDUCE EXPOSURE to certain organic vapors encountered during activities involving latex and oil-based painting, including paint spraying*, varnishes, stains, sealants, solvents, certain solvent-based cleaners or pesticides** *Use a prefilter when spraying **Refer to Pesticide Product Label for Respirator Guidance or call 3M at 1-800-243-4630 or In Canada, call 1-800-267-4414
5P71 FILTER HELPS REDUCE EXPOSURE to certain particles from paint spraying*, spray adhesives and pesticides**. **Refer to Pesticide Product Label for Respirator Guidance or call 3M at 1-800-243-4630 or In Canada, call 1-800-267-4414

Typical properties

Application Type
Paint Project
Brands
3M™
Cartridge or Filter Included
Yes
Cartridge or Filter Type
Gas & Vapor
Catalog Number
7512PA1-A-PS
Clip-on Welding Shield
No
Compatible with 3M™ PAPR Systems
No
Compatible with 3M™ Supplied Air System

Dimensions and Classifications

Overall Height (Imperial)

9.6 in

Overall Height (Metric)

24.384 cm

Overall Length (Imperial)

5.5 in

Overall Length (Metric)

13.97 cm

Overall Width (Imperial)

8.5 in

Overall Width (Metric)

25.4 cm

3M™ Cool Flow™ Valve Respirator Paint Protection - Advanced Comfort 7513 (L)

3M ID 70006963055 UPC 00051131527669

Details

NIOSH-APPROVED 6001 OV CARTRIDGE for use against certain organic vapors
NIOSH-APPROVED 5P71 P95 RATED filters for at least 95% filtration efficiency against solids and liquid aerosols, as well as oil-based particulates
FOR WORKPLACE/OCCUPATIONAL USE ONLY
OIL PROOF P-series particulate filter
3M™ COOL FLOW™ VALVE helps direct exhaled breath downward
ADJUSTABLE HEAD STRAPS allow for a personalized fit
KIT CONTENTS: one facepiece, one pair of 6001 cartridges, one pair of 501 retainers and two pairs of 5P71 filters
CONVENIENT, REUSABLE DESIGN
DURABLE DESIGN for lasting wear
LIGHTWEIGHT, SILICONE FACESEAL for premium comfort
3M™ BAYONET CONNECTION compatible with 3M™ cartridges and filters
VALVE COVER DESIGN directs exhaled breath downward
SMOOTH SURFACE for quick & easy cleaning
6001 OV CARTRIDGE HELPS REDUCE EXPOSURE to certain organic vapors encountered during activities involving latex and oil-based painting, including paint spraying*, varnishes, stains, sealants, solvents, certain solvent-based cleaners or pesticides**. *Use a prefilter when spraying **Refer to Pesticide Product Label for Respirator Guidance or call 3M at 1-800-243-4630 or In Canada, call 1-800-267-4414
5P71 FILTER HELPS REDUCE EXPOSURE to certain particles from paint spraying*, spray adhesives and pesticides**. **Refer to Pesticide Product Label for Respirator Guidance or call 3M at 1-800-243-4630 or In Canada, call 1-800-267-4414

Typical properties

Application Type
Paint Project
Brands
3M™
Cartridge or Filter Included
Yes
Cartridge or Filter Type
Gas & Vapor
Catalog Number
7513PA1-A-PS
Clip-on Welding Shield
No
Compatible with 3M™ PAPR Systems
No
Compatible with 3M™ Supplied Air System

Dimensions and Classifications

Overall Height (Imperial)

9.6 in

Overall Height (Metric)

24.384 cm

Overall Length (Imperial)

5.5 in

Overall Length (Metric)

13.97 cm

Overall Width (Imperial)

8.5 in

Overall Width (Metric)

25.4 cm

3M™ Cool Flow™ Valve Respirator Paint Protection - Advanced Comfort 7511 (S)

3M ID 70006963030 UPC 00051131527645

Details

NIOSH-APPROVED 6001 OV CARTRIDGE for use against certain organic vapors
NIOSH-APPROVED 5P71 P95 RATED filters for at least 95% filtration efficiency against solids and liquid aerosols, as well as oil-based particulates
FOR WORKPLACE/OCCUPATIONAL USE ONLY
OIL PROOF P-series particulate filter
3M™ COOL FLOW™ VALVE helps direct exhaled breath downward
ADJUSTABLE HEAD STRAPS allow for a personalized fit
KIT CONTENTS: one facepiece, one pair of 6001 cartridges, one pair of 501 retainers and two pairs of 5P71 filters
CONVENIENT, REUSABLE DESIGN
DURABLE DESIGN for lasting wear
LIGHTWEIGHT, SILICONE FACE SEAL for premium comfort
3M™ BAYONET CONNECTION compatible with 3M™ cartridges and filters
VALVE COVER DESIGN directs exhaled breath downward
SMOOTH SURFACE for quick & easy cleaning
6001 OV CARTRIDGE HELPS REDUCE EXPOSURE to certain organic vapors encountered during activities involving latex and oil-based painting, including paint spraying*, varnishes, stains, sealants, solvents, certain solvent-based cleaners or pesticides** *Use a prefilter when spraying **Refer to Pesticide Product Label for Respirator Guidance or call 3M at 1-800-243-4630 or In Canada, call 1-800-267-4414
5P71 FILTER HELPS REDUCE EXPOSURE to certain particles from paint spraying*, spray adhesives and pesticides**. **Refer to Pesticide Product Label for Respirator Guidance or call 3M at 1-800-243-4630 or In Canada, call 1-800-267-4414

Typical properties

Application Type
Paint Project
Brands
3M™
Cartridge or Filter Included
Yes
Cartridge or Filter Type
Gas & Vapor
Catalog Number
7511PA1-A-PS
Connection Type
Bayonet
Facepiece Material
Silicone
Factory ISO Certification
No ISO Certification i

Dimensions and Classifications

Overall Height (Imperial)

9.625 in

Overall Height (Metric)

24.384 mm

Overall Length (Imperial)

5.5 in

Overall Length (Metric)

13.97 mm

Overall Width (Imperial)

10 in

Overall Width (Metric)

25.4 mm

3M™ DBI-SALA® Wall Mount Sleeve Davit Base

Details

Wall mount sleeve davit base
Bolt or weld to vertical walls
360 degree davit mast rotation
PVC davit mast sleeve liner
Permanent installation with standard tools
Durable stainless steel hardware
Also available in stainless steel

Typical properties

Case Quantity
1
Connected Safety ID Equipped
No
Dimensions
10.00x4.30x9.30lbs,25.40x10.90x23.60cm
Install Type
Portable
Material
Galvanized Steel, Stainless Steel
Product Series
Advanced™
Product Type
Wall Mount Sleeve Davit Base
Recommended

3M™ Versaflo™ Easy Clean Holster TR-657, 1 EA/Case

3M Product Number TR-657 3M ID 7100127542 UPC 00051131275348

Details

Easy Clean

Provides protection and stability for 3M™ Versaflo™ Battery Adapter TR-659

Typical properties

Brands

Versaflo™

Case Quantity

1/pack

Compatible Respirator Type

PAPR

Compatible With

3M™ Breathe Easy™ PAPR, 3M™ GVP-Series PAPR

Enhanced Comfort

Yes

Intrinsically Safe

No

Mounting Type

Belt-mounted

Product Series

Versaflo

Product Type

H

3M™ Versaflo™ Heavy Duty Holster TR-656, 1 EA/Case

3M Product Number TR-656 3M ID 7100127543 UPC 00051131275355

Details

Heavy Duty

Durable

Provides protection and stability for 3M™ Versaflo™ Battery Adapter TR-659

Typical properties

Brands

Versaflo™

Case Quantity

1/pack

Compatible Respirator Type

PAPR

Compatible With

3M™ Breathe Easy™ PAPR, 3M™ GVP-Series PAPR

Enhanced Comfort

Yes

Intrinsically Safe

No

Material

Leather

Mounting Type

Belt-mounted

Product Series

GVP, V

3M™ Powerflow™ High Efficiency SP3 Particulate Filter System Component 450-01-01R20 20 EA/Case

3M Product Number 450-01-01R20 3M ID 7000131701 UPC 50051138720037

Details

For use with 3M™ Powerflow™ Powered Air Purifying Respirator (PAPR)
Systems
NIOSH-approved

Typical properties

Brands
Powerflow™
Case Quantity
20
Compatible Respirator
Powerflow
Compatible with 3M™ PAPR Systems
Yes
Headgear Type
Full Facepiece
NIOSH Cartridge or Filter Assigned Color Coding
Magenta
Product Color
Black
Product Series
Powerflow
Produ

3M™ Goggle Clip For Hard Hat, 46448-00000, 10 Pair/Case

3M Product Number 46448-00000 3M ID 7000127229 UPC 10078371464483

Details

Clips allow connection to hard hat

Goggles can go below brim when in use or slide above brim when not in use

Typical properties

Brands

3M™

Compatible Hard Hat

H-700, H-800

For Use With

Hard Hats

Material

Plastic

Product Color

Transparent

Product Type

Goggle Clip

eClass 14 Classification Group

46080105

3M™ Adflo™ Powered Air Purifying Respirator System with a Versaflo™ M-Series Helmet and Speedglas™ Welding Shield Upgrade Kit

Details

PAPR includes a blower unit, breathing tube, flow indicator, spark arrestor, belt, filters, filter cover, lithium ion battery, and charger

Versaflo™ M-Series Helmet has a tough leather shroud to help protect welding arc, sparks and spatter

Selectable Shades 5, 8-13 and Shade 3 light state

Wide, transparent faceshield for a clear view

Hard headcover helps protect against falling objects and flying debris

Recommended for heavy industrial, metal fabrication, metal production, and fabrication industries

Applications include arc gouging, plasma cutting, grinding, MIG, TIG, and GMAW welding

Option to buy protection headgear with or without Speedglas™ Welding ADF

Typical properties

ADF Model

9100XXi, None

Air Source

PAPR

Comes with Auto-Darkening Filter (ADF)

No, Yes

Features

Dual Face Protection, Eye & Face Protection, Head Protection

Grinding Option

Flip-up with Clear Visor

Headgear Type

Hardhat with Faceshield and Weld

3M™ PROTECTA® PRO™ Concrete D-ring Anchor with Bolt 2190055, 1 EA

Part Number 2190055 3M Product Number 2190055 3M ID 7100207457

Details

Rugged and corrosion resistant material construction for durability with compact and lightweight design
Use vertically in wall or horizontally in ceiling (both components)
High strength steel construction
Compatible with various fall arrest systems
Meets the requirements for 29 CFR OSHA 1910.140, and OSHA 1926.502
Recommended for use in the construction, general industrial, mining, oil and gas, and utilities industries
This safety equipment is designed for use with additional personal fall protection systems (PPE)
Installs into 3/4 in. or 18 mm concrete holes
Reusable detent D-ring assembly - extra sockets (#2101000) and detent D-rings (#2101002) also available
Install as temporary or permanent anchor
Swiveling D-ring tie-off point

Typical properties

Anchor Install Type
Permanent
Attachment Type
Screw
Brands
PROTECTA®
Case Quantity
1
Connected Safety ID Equipped
No
Dimensions
5.70x5.70x4.40in
Install Type
Reusable or Permanent
Material
Galvanized Steel
Product Color
Silver
Product Se

3M™ DBI-SALA® Suspension Seats

Details

Intended for use with personal protective equipment, including fall arrest systems and other safety supplies
Robust range of suspension seats designed for enhanced comfort while suspended
Helps meet safety requirements for fall protection applications

Typical properties

Belly Pad
No
Belt Type
None, Waist
Board/Seat Cushion
No, Yes
Board/Seat Material
13-Ply Maple Plywood, 15-Ply Apple Plywood, Nylon Web
Buckle Material
Stainless Steel Grommet, Zinc Plated Steel
Buckle Type
None, Pass-through, Tongue Buckle
Ca

Dimensions and Classifications

Overall Length (Imperial)
18 in, 24 in, 30 in
Overall Length (Metric)
45.72 cm, 47.72 cm, 60.96 cm, 76.2 cm
Overall Width (Imperial)
8 in, 12 in, 15 in
Overall Width (Metric)
20.32 cm, 30.48 cm, 38.1 cm

3M™ DBI-SALA® Vehicle Hitch Mount Sleeve Davit Base

Details

Installs into 2-in. vehicle receiver hitch
Adjustable height T-bar
Set up and dismantle without tools
Durable construction
Available in two options: 27.5 in. maximum offset davit mast and 42.5 in. maximum offset davit mast
Recommended for use in all industries
Set-up and dismantle without tools
Durable and corrosion resistant construction

Typical properties

Case Quantity
1
Connected Safety ID Equipped
No
Dimensions
102.50x131.40x91.40cm,102.50x253.30x91.40cm
Install Type
Portable
Product Color
Green, Silver
Product Type
Replacement Parts & Accessories
Recommended Industry
Construction, General I

3M™ DBI-SALA® Lad-Saf™ Grab Bar Extension Top Bracket

Details

Top Bracket Grab Bar Extension for 3M™ DBI-SALA® Lad-Saf™
Durable Steel construction
Various options of brackets for different bracket styles and sizes

Typical properties

Attachment Type
Bolt-On, Four Rungs, None
Case Quantity
1
Connected Safety ID Equipped
No, Yes
Dimensions
1.5 in x 5.5 in x 66.5 in, 3 in x 2 in x 49.5 in
For Use With
Fixed Ladders
Install Type
Permanent
Maximum Number of Users
1-4 Users, One

3M™ PELTOR™ Hard Hat Guide Arms Assembly P3EG-PK, 1 Pair/Case

3M Product Number P3EG-PK 3M ID 7010384839 UPC 00093045937202

Details

Guide arms for Select 3M™ PELTOR™ Headsets

Typical properties

Brands
PELTOR™
For Use With
Hard Hats
Product Type
Guide Arm Assembly
eClass 14 Classification Group
46080105

3M™ Scott™ Cylinders

3M ID B5005047162

Details

Carbon fiber and aluminum cylinder designs
Available in 2216, 4500, or 5500 psig
Snap-Change or CGA-threaded cylinder connection
Optional custom-logo cylinder identification bands
30-year-life cylinders--available in certain markets
Optional protective cylinder sleeves and end caps available

Typical properties

Brands
Scott™
eClass 14 Classification Group
51010302

3M™ DBI-SALA® Incline Winch/SRL Adaptor Bracket

Details

Winch/SRL mating mounting bracket adaptor

Offers quick mount system to structure

Durable zinc plated steel construction

Compact and lightweight design

Available in 30 and 40 degree incline to fit 11-1/2 in. to 27-1/2 in. (29.2 to 69.8 cm) and 23-1/2 in. to 42-1/2 in. (59.7 to 108 cm) offset upper davit masts

Typical properties

Case Quantity

1

Connected Safety ID Equipped

No

Net Weight (Imperial)

2.4 lb, 2.7 lb

Net Weight (Metric)

1.1 kg, 1.2 kg

Product Color

Silver

Product Series

Advanced™

Product Type

30 Degree Incline Winch/SRL Adaptor Bracket, 40 Degree Incline

3M™ SecureFit™ X5000 Series Short Visors

Details

Molded out of polycarbonate for impact protection in a variety of applications
Features an anti-fog, anti-scratch coating
Available in clear, grey, and amber
Fits 3M™ SecureFit™ X5000 Series Safety Helmets

Typical properties

Brands

3M™

Case Quantity

10

Product Type

Short Faceshield

Recommended Application

Demolition, Forestry, Grinding, Remediation

Recommended Industry

Construction, General Manufacturing, Heavy Infrastructure, Industrial

Maintenance, Oil & Gas

Shape

Dimensions and Classifications

Overall Height (Imperial)

4 in

Overall Height (Metric)

10 cm

Overall Length (Imperial)

16.92 in

Overall Length (Metric)

42.98 cm

3M™ DBI-SALA® Nano-Lok™ Self-Retracting Lifeline

Details

- Compact & lightweight design
- Quick activating speed sensing brake system
- Durable thermoplastic housing
- Swivelling anchorage loop
- Built-in connector for direct attachment to harness
- High capacity external energy absorber and impact indicator
- RFID equipped and compatible with inventory management system
- Available in multiple styles and configurations

Typical properties

- ANSI Class Level
- Class 1
- Anchor Connection Type
- Cab-mount Bracket, Carabiner, Rebar Hook, Tie-back Snap Hook
- Anchor Hook Material
- Zinc Plated Steel
- Anchor Hook Material
- Steel & Stainless Steel, Zinc Plated Steel
- Average Arrest Force (Imperial)
- 11

Dimensions and Classifications

- Overall Length (Imperial)
- 6 ft, 8 ft, 9 ft, 11 ft
- Overall Length (Metric)
- 1.83 m, 2.4 m

3M™ Scotchlite™ Reflective Material 9945 Series

Details

Brightness: Compliant brightness designed for enhancing visibility of wearer in low light and nighttime conditions. 5545 construction enables material to be brighter longer throughout washings
Off-Angle Brightness: 32-angle table brightness compliance to help keep wearers visible from many angles
Wash Durability: Next generation wash longevity and brightness over the life of the material
Flame-Resistance: Certified to major flame-resistance standards

Typical properties

Attachment Type
Sew On
Backing
100% Aramid
Backing Material
Aramid
Brands
Scotchlite™
Configurable
No, Yes
Daytime Color
Silver
Dry-Cleaning Cycles at ANSI Certified Standards
50
Dry-Cleaning Cycles at ISO Certified Standards
50
Flame Res

Dimensions and Classifications

Overall Length (Imperial)
54.68 yd, 109.36 yd, 218.72 yd
Overall Length (Metric)
50 m, 100 m, 200 m
Overall Width (Imperial)
0.5 in, 0.75 in, 1 in, 1.18 in, 1.575 in, 2 in, 2.36 in, 2.75 in, 36 in, 50 in
Overall Width (Metric)
12.7 mm, 19.05 mm, 25

3M™ DBI-SALA® Fixed Ladder SRL Anchor

Details

Easy to transport. Under 30 lbs. for ease of transport and installation
Simple to setup up installs on the ladder in 5 minutes or less. Versatile installation allows the ladder anchor to be mounted to front or behind the ladder with left, right or center alignments
Compatible with your existing fall protection harness. Unlike a fixed cable system, this solution doesn't require a front D-ring, which can reduce overall implementation costs
Designed for durability and built to withstand permanent or temporary applications
Meets requirements of 29 CFR OSHA 1910 Walking Working Surfaces Section 1910.27
Available in galvanized or stainless steel

Typical properties

Anchor Hook Material
Metal
Anchor Install Type
Permanent & Reusable
Anchor Type
Stainless Steel
Carabiner/Hook Material
Metal
Case Quantity
1 each
Connected Safety ID Equipped
No
For Use With
3M™ DBI-SALA® Smart Lock 3503800, 30 ft., 3M™ DBI-

Dimensions and Classifications

Overall Length (Imperial)
6 ft, 6.67 ft, 8.75 ft
Overall Length (Metric)
1.828 m, 2.03 m, 2.67 m

3M™ Tri-Flange™ Probed Test Plugs 393-2011-50, 10 Pair/Bag, 5 Bags EA/Case, 50 EA/Case

3M Product Number 393-2011-50 3M ID 7000128263 UPC 10093045937124

Details

pecially probed version of the standard plug
works with the E-A-Rfit™ Validation System
allows you to conduct an earplug fit test for the Tri-Flange and UltraFit Plus
earplugs

*The NRR may overestimate the hearing protection provided during typical use

Typical properties

Brands

3M™

Case Quantity

5

Earplug Shape

Flanged

Material

Elastomeric Polymer

Product Color

Transparent

Product Series

E-A-Rfit

Product Type

Probed Test Earplug

Recommended Application

Health & Safety Testing

eClass 14 Classification Group

3M™ PELTOR™ WS™ LiteCom Plus Headset MT73H7P3E4610WS6NA, Hard Hat Attached, 5 ea/Case

3M Product Number MT73H7P3E4610WS6NA 3M ID 7100204436 UPC 07318640069633

Details

Protective communication solution for hands-free, clear communication in noisy environments

Helps provide hearing protection when exposed to hazardous noise

Analog two-way communication radio with 22 pre-programmed FRS channels

Environmental listening technology helps provide protection when it's loud, as well as helps workers hear environmental sounds when it's not

Bluetooth® multipoint technology for simultaneous, wireless connection to two devices

Water and dust-proof noise-cancelling microphone (IP68) for clear speech transmission in noisy and harsh environments

Auxiliary port and a PTT button on the earcup allows for a wired connection to a wide variety of 2-way radios

Built tough for the working professional

Headset is water and dust resistant (IP54)

Comfortable for all day wearability

Typical properties

Attenuation Rating

25 dB

Audio Type

Communication

Auxiliary Port

4-pin XLR

Battery Life

Approx. 18 hours

Battery Type

Lithium-Ion

Bluetooth

Yes

Brands

PELTOR™

Built in 2-Way Radio

Yes

CSA Class

CSA Class A

Case Quantity

5/Case

Communic

3M™ PELTOR™ WS™ LiteCom Plus Headset MT73H7B4610WS6NA, Neckband, 5 ea/Case

3M Product Number MT73H7B4610WS6NA 3M ID 7100204390 UPC 07318640069626

Details

Protective communication solution for hands-free, clear communication in noisy environments

Helps provide hearing protection when exposed to hazardous noise

Analog two-way communication radio with 22 pre-programmed FRS channels

Environmental listening technology helps provide protection when it's loud, as well as helps workers hear environmental sounds when it's not

Bluetooth® multipoint technology for simultaneous, wireless connection to two devices

Water and dust-proof noise-cancelling microphone (IP68) for clear speech transmission in noisy and harsh environments

Auxiliary port and a PTT button on the earcup allows for a wired connection to a wide variety of 2-way radios

Built tough for the working professional

Headset is water and dust resistant (IP54)

Comfortable for all day wearability

Typical properties

Attenuation Rating

27 dB

Audio Type

Communication

Auxiliary Port

4-pin XLR

Battery Life

Approx. 18 hours

Battery Type

Lithium-Ion

Bluetooth

Yes

Brands

PELTOR™

Built in 2-Way Radio

Yes

CSA Class

CSA Class A

Case Quantity

5/Case

Communic

3M™ PELTOR™ WS™ LiteCom Plus Headset MT73H7A4610WS6NA, Headband, 5 ea/Case

3M Product Number MT73H7A4610WS6NA 3M ID 7100204433 UPC 07318640069619

Details

Protective communication solution for hands-free, clear communication in noisy environments

Helps provide hearing protection when exposed to hazardous noise

Analog two-way communication radio with 22 pre-programmed FRS channels

Environmental listening technology helps provide protection when it's loud, as well as helps workers hear environmental sounds when it's not

Bluetooth® multipoint technology for simultaneous, wireless connection to two devices

Water and dust-proof noise-cancelling microphone (IP68) for clear speech transmission in noisy and harsh environments

Auxiliary port and a PTT button on the earcup allows for a wired connection to a wide variety of 2-way radios

Built tough for the working professional

Headset is water and dust resistant (IP54)

Comfortable for all day wearability

Typical properties

Attenuation Rating

27 dB

Audio Type

Communication

Auxiliary Port

4-pin XLR

Battery Life

Approx. 18 hours

Battery Type

Lithium-Ion

Bluetooth

Yes

Brands

PELTOR™

Built in 2-Way Radio

Yes

CSA Class

CSA Class A

Case Quantity

5/Case

Communic

3M™ Hard Hat Replacement Brow-Pad H-700BP, 20 EA/Case

3M Product Number H-700-BP 3M ID 7000030093 UPC 10078371654914

Details

Approved replacement part for 3M™ H-700 series hard hats
Soft pad cushions contact point with forehead
Ventilation holes allow air circulation to keep worker cooler
Designed for quick and simple replacement
Replacement part can extend service life of hard hat

Typical properties

Brands
3M™
Case Quantity
20
Compatible Hard Hat
H-700, H-700T, H-800
For Use With
3M™ Headgear Systems, Hard Hats
High Heat
Yes
Material
Vinyl
Product Color
Black
Product Series
H-700
Product Type
Brow Pad
Recommended Industry
Commercial

Dimensions and Classifications

Overall Height (Imperial)
0.25 in
Overall Height (Metric)
0.64 cm
Overall Length (Imperial)
11 in
Overall Length (Metric)
27.94 cm
Overall Width (Imperial)
5 in
Overall Width (Metric)
12.7 cm

3M™ SecureFit™ Hard Hat Replacement Brow-Pad SFH-700-BP, 20 ea/Case

Part Number SFH-700-BP 3M Product Number SFH-700-BP 3M ID 7100247652

Details

Approved replacement part for 3M™ SecureFit™ SFH-700 series and SFH-800 series hard hats

Designed for quick and simple replacement

Soft pad cushions contact point with forehead

Ventilation holes allow air circulation

Replacement part can extend service life of hard hat

Typical properties

Brands

SecureFit™

Case Quantity

20

Compatible Hard Hat

H-700, H-800

Product Type

Brow Pad

eClass 14 Classification Group

46080105

3M™ PELTOR™ Probed Electronic Earplugs

Details

These test earpieces are modified with a probe tube for use during fit testing with the 3M™ E-A-Rfit™ Dual-Ear Validation System
Contains 10 probed earpieces and 50 pair of eartips per case
3M PSD products are occupational use only

Typical properties

Case Quantity
10 Earpieces and 50 Pair of Eartips
Earplug Shape
Flanged, Tapered
Earplug Size
Large, Medium, One Size Fits Most, Small
Material
ABS/Elastomeric Polymer, Polyurethane
Product Color
Brown, Gray, Tan
Product Type
Probed Test Earplu

3M™ DBI-SALA® Fall Protection for Tools Body Tethers

Details

Compatible with 3M™ DBI-SALA® Fall Protection for Tools accessories
Enable workers to secure tools and accessories while working at height
Multiple capacities, materials, lengths, and connector options designed for a variety of applications

Typical properties

Case Quantity

1,100,10

Connected Safety ID Equipped

No

Dimensions

6.00 x 12 x 0.25 inch,36 x 0.50 inch,9.00 x 4.00 x 1.00 inch,10.00 x 2.75 x 1.12 inch,12 x 0.50 inch,24 x 0.50 inch

Manufacturing Origin

Taiwan, USA

Net Weight (Imperial)

0.11 lb,

Dimensions and Classifications

Overall Height (Imperial)

2.15 in

Overall Height (Metric)

15.24 mm, 21.44 mm, 25.4 mm, 30.48 mm, 31.75 mm, 35.57 mm, 41.91 mm, 42.75 mm, 45.72 mm, 53.34 mm, 54.61 mm, 57.15 mm, 60 mm, 80.01 mm

Overall Length (Imperial)

10 in, 12.3 in, 62 in

Overall

3M™ SecureFit™ Elevated Temperature Hard Hat

Details

Suspension system incorporates exclusive patented SecureFit™ Pressure Diffusion Technology

Designed to withstand radiant heat loads up to but not exceeding 375°F (190°C)

Compatible with cap-attached 3M hearing protection and communication products, a variety of 3M faceshields and other accessories

Customize your fit with multiple levels of height and head-shape adjustments

Premium washable and replaceable sweatband with moisture-wicking material is designed to help keep workers cool and dry

Meets ANSI Z89.1 and CSA Z94.1 Safety Compliance Standards

Typical properties

Case Quantity

10

Electrical Class

E, G

Features

Pressure Diffusion Technology

Hard Hat Type

Type I

Product Type

Cap Style Hard Hat

Suspension Type

4 Point Ratchet

Vented

No

eClass 14 Classification Group

40300202

3M™ PELTOR™ SCU-300 Attachment Clip TKD8003/1, 20 ea/Case

3M Product Number TKD8003/1 3M ID 7100228539 UPC 07318640070936

Details

Replacement SCU Attachment Clip
Ruggedized

Typical properties

Brands
PELTOR™
Case Quantity
20
Compatible With
SCU-300 System Control Unit
Product Color
Metallic Silver
Product Type
Attachment Clip
eClass 14 Classification Group
40270191

3M™ Adflo™ Powered Air Purifying Respirator Battery Promotional Kit

35-1099-17, 1 Kit EA/Case

3M Product Number 35-1099-17 3M ID 7100025243 UPC 00051141563305

Details

Adflo Promotional Kit
Rechargeable
Standard or heavy duty

Typical properties

Battery Life
PAPR: up to 12 hours
Battery Type
PAPR: Lithium ion
Brands
Adflo™
Cartridge or Filter Included
HE Filter
Case Quantity
1
Compatible With
3M™ Adflo™ PAPR
Features
Upgrade Kit
Intrinsically Safe
No
NIOSH Cartridge or Filter Assi

3M™ Secure Click™ Particulate Filter N95 D7N11, 200 EA/Case

3M Product Number D7N11 3M ID 7100213450 UPC 50051131278092

Details

Works with 3M™ Secure Click™ Cartridges D8000 Series
Held in place by required 3M™ Secure Click™ Filter Retainer D701
NIOSH-approved N95 particulate filter for respiratory protection against certain non-oil based particulates
Allows for replacement of filters prior to change out of cartridges for cost savings
Use two D7N11 filters per D8000 Series cartridge for a total of 4 filters per facepiece
For workplace/occupational use only
Package contents: 1 case contains 10 boxes of 20 filter each (200 each total)

Typical properties

Accessories
No
Brands
Secure Click™
Cartridge or Filter Type
Particulate
Clip-on Welding Shield
No
Compatible Respirator
3M™ Secure Click™ Half Facepiece Reusable Respirators HF-800 Series
Compatible with 3M™ PAPR Systems
No
Compatible with 3M

Dimensions and Classifications

Overall Height (Metric)
5 mm
Overall Length (Metric)
81 mm
Overall Width (Metric)
85 mm

3M™ E-A-Rsoft™ Yellow Neons™ Earplugs

Details

Tapered shape and smooth soft texture for fit and comfort

Slow-recovery foam designed for easier insertion

Compatible with the 3M™ E-A-Rfit™ Validation System

Available with and without cords

Available in two sizes-regular and large

Features a Noise Reduction Rating (NRR)* of 33 dB for regular and large size in combination; 32 dB for regular size alone

CSA Class AL

*U.S. EPA specifies the NRR as the measure of hearing protector noise reduction. However, 3M makes no warranties as to the suitability of the NRR for this purpose. 3M strongly recommends personal fit testing of hearing protectors. Research suggests that users may receive less noise reduction than indicated by the attenuation label value(s) on the packaging due to variation in fit, fitting skill, and motivation of the user. Refer to applicable regulations or guidance on how to adjust attenuation label values. It is recommended that the NRR be reduced by 50% to better estimate typical protection

Typical properties

Attenuation Rating

33.0 Decibel,32.0 Decibel

Banded

No

Brands

E-A-R™

Case Quantity

1600 Pair,2000 Pair

Cord Color

Blue

Cord Material

Metal Detectable Cord, Vinyl

Cord Type

Metal Detectable Cord, None, Vinyl

Corded

No, Yes

Dielectric

No

D

3M™ PELTOR™ LiteCom FRS Headset MT53H7P3E4602-NA, Hard Hat Attached, 10 ea/Case

3M Product Number MT53H7P3E4602-NA 3M ID 7100204440 UPC 07318640069688

Details

Protective communication solution for hands-free, clear communication in noisy environments

Helps provide hearing protection when exposed to hazardous noise

Analog two-way communication radio with 22 pre-programmed FRS channels

Noise-cancelling microphone for clear speech transmission in noisy environments

Push-to-Talk (PTT) or hands-free Voice Operated (VOX) transmit options

Operates on AA batteries or rechargeable NiMH battery pack

Voice guided headset menu for easy operation

Built tough for the working professional

Comfortable for all day wearability

Typical properties

Attenuation Rating

24 dB

Audio Type

Communication

Auxiliary Port

J22

Battery Life

Approx. 20 hours

Battery Type

AA or Rechargeable NiMH Pack, Disposable AA

Bluetooth

No

Brands

PELTOR™

Built in 2-Way Radio

Yes

CSA Class

CSA Class B

Commun

3M™ Solus™ 1000 Series Replacement TPE Gasket S1000-TPE, 20 ea/Case

Part Number S1000-TPE 3M Product Number S1000-TPE 3M ID 7100232857

Details

Flexible TPE gasket adapts to wearer's face contours to provide a seal and help protect against debris, dust and splash

TPE Gasket Accessory can be used to replace or add a sealed gasket to any Solus 1000 model

Compatible with all Solus(TM) 1000 Series models

Typical properties

Brands

Solus™

Case Quantity

20

For Use With

3M™ Solus™ 1000 Series Protective Eyewear

Material

TPE Foam

Product Series

1000

Product Type

Gasket

Recommended Application

Assembly, Automotive, Aviation, Chemical Handling, Chemicals, Chiseling, C

3M™ SecureFit™, Replacement Foam Gasket, SF-FOAM, 20/bag

3M Product Number SF-FOAM 3M ID 7100112132 UPC 00051131274761

Details

Removable foam-lined gasket helps keep debris out of your eyes while providing comfort and cushioning. Fits 3M™ SecureFit™ protective eyewear 400-series
3M™ SecureFit™ Protective Eyewear offers 3M™ Pressure Diffusion Technology
3M™ SecureFit™ Protective Eyewear 400 Series offers anti-fog/Anti-Scratch Lens Coating
3M™ SecureFit™ Protective Eyewear 400 Series offers soft one-piece nose bridge

Typical properties

Brands

SecureFit™

Dimensions

1.7" L x 5.4" W x 1.9" H

Eyewear Range

Value

For Use With

3M™ SecureFit™ 400 Series Protective Eyewear

Material

Foam

Product Series

400

Product Type

Gasket

Recommended Industry

Automotive, Aviation, Construction

3M™ Solus™ Replacement Foam Gasket, 10 ea/Bag

3M Product Number Solus-Foam 3M ID 7100079749

Details

Replacement part for use with 3M™ Solus™ 1000 Series Safety Eyewear
Removable feature allows gasket to be taken off glasses
Ventilation holes help reduce fogging
10ea/bag

Typical properties

Brands

Solus™

For Use With

3M™ Solus™ 1000 Series Safety Glasses

Material

Foam

Product Series

1000

Product Type

Gasket

Recommended Application

Assembly, Cleaning, Demolition, Drilling, Facility Maintenance, Grinding,
Machining, Masonary, Remedi

Dimensions and Classifications

Overall Height (Imperial)

3.25 in

Overall Height (Metric)

8.26 cm

Overall Length (Imperial)

6.87 in

Overall Length (Metric)

17.46 cm

Overall Width (Imperial)

5.87 in

Overall Width (Metric)

14.92 cm

3M™ DBI-SALA® SecuraSpan™ Rebar/Shear Stud Horizontal Lifeline System

7400650, 50 ft. (15.2 m), 1 ea

Part Number 7400650 3M Product Number 7400650 3M ID 7100220319

Details

Complete 50 ft. (15.2m) system includes two stanchions with tie-back and cable assemblies
Adjustable stanchion can be offset 20 degrees left or right or set completely horizontal for transport
Rugged 3/8" (9.5mm) 7x19 galvanized cable lifeline
Metal energy absorber limits fall arrest forces
Fits 1/2 in. (12.7 mm) to 1 in. (25.4 mm) diameter (#4 to #8 rebar) and 4 in. to 12 in. center to center (10.1-30.5 cm)
Single and multi-span indefinite length system configurations
Flexible system capacity
Equipped with RFID
Top mounted adjustment system
Simple chain tie-back connection

Typical properties

Brands
DBI-SALA®
Case Quantity
1
Connected Safety ID Equipped
Yes
For Use With
3M™ DBI-SALA® SecuraSpan™ Rebar/Shear Stud HLL System
Install Type
Temporary/Portable
Lifeline Material
Galvanized Cable
Maximum Number of Workers
2 Per Span, 6 To

Dimensions and Classifications

Overall Length (Imperial)
50 ft
Overall Length (Metric)
15.2 m

3M™ DBI-SALA® Adjustable Web Positioning Lanyard for Nano-Lok™ SRL 1231076, 3 ft

Part Number 1231076 3M Product Number 1231076 3M ID 7012817016

Details

Adjustable single-leg lanyard
Ideal for restraint in lift equipment
Abrasion resistant polyester webbing
Integrated Nano-Lok™ twin leg connector at one end
Built-in wear indicator

Typical properties

Anchor Connection Type
Rebar Hook
Anchor Hook Material
Zinc Plated Steel
Brands
DBI-SALA®
Case Quantity
1
Connected Safety ID Equipped
No
Energy Absorber Class
None
For Use With
Nano-Lok™
Harness Connection Hook Material
Zinc Plated Steel

Dimensions and Classifications

Overall Length (Imperial)
3 ft

3M™ DBI-SALA® Nano-Lok™ Web Adjustable Restraint Lanyard 1231077, 1 EA

3M Product Number 1231077 3M ID 7100224724 UPC 00648250168103

Details

Adjustable single-leg lanyard
Ideal for restraint in lift equipment
Abrasion resistant polyester webbing
Integrated Nano-Lok™ twin leg connector at one end
Built-in wear indicator

Typical properties

Anchor Connection Type
Rebar Hook
Anchor Hook Material
Zinc Plated Steel
Brands
DBI-SALA®
Case Quantity
1
Connected Safety ID Equipped
No
Energy Absorber Class
None
For Use With
Nano-Lok™
Harness Connection Hook Material
Zinc Plated Steel

Dimensions and Classifications

Overall Length (Imperial)
6 ft

3M™ DBI-SALA® Roof Top Anchor - For Standard Membrane Roofs 2100139

Part Number 2100139 3M Product Number 2100139 3M ID 7100228425

Details

Durable materials and hardware designed to help stand up to harsh working conditions
Compatible with various fall arrest systems
Suitable for use in general industrial and construction industries
Compact, lightweight design
Meets the requirements for 29 CFR OSHA 1910.140 and 29 CFR OSHA 1926.502
Features corrosion-resistant, steel and aluminum construction for durability
This safety equipment is designed for use with additional personal protective equipment (PPE)
Installs to standard membrane and built-up type roofs for use on flat or sloped (up to 3:12 pitch). Fastens through membrane, insulation and into metal, wood or concrete
Swiveling tie-off point for complete mobility. Load distributing design protects roof and user
Multi-person use with horizontal lifeline system with multiple fastener options available
Aesthetic design compliments the roof - Thermal efficient design and construction. Complete with shroud offering maximum weather proofing

Typical properties

Anchor Install Type
Permanent
Attachment Type
Toggle Bolt
Brands
DBI-SALA®
Case Quantity
1
Connected Safety ID Equipped
No
Dimensions
(16.00x16.00x9.00)in
For Use With
Standard Membrane Roofs
Install Type
Permanent
Material
Zinc Plated St

3M™ DBI-SALA® Parts Pouch, Canvas Black 1500119, Small

3M Product Number 1500119 3M ID 7100156938 UPC 00852684932241

Details

Compatible with 3M™ DBI-SALA® and Protecta® Fall Protection systems and components

Enable workers to secure tools and accessories while working at height

Multiple materials, closure systems, and attachment point options designed for a variety of applications

Typical properties

Brands

DBI-SALA®

Case Quantity

1

Connected Safety ID Equipped

No

Manufacturing Origin

Taiwan

Net Weight (Metric)

0.22 kg

Product Color

Black

Product Type

Small Parts Pouch

Recommended Industry

Construction, General Industrial, Mining, Oil &

Dimensions and Classifications

Overall Height (Metric)

80.01 mm

Overall Length (Metric)

284.48 mm

3M™ DBI-SALA® Parts Pouch, Canvas Camo 1500120, Small, 1 EA

3M Product Number 1500120 3M ID 7100214255 UPC 00852684932265

Details

Compatible with 3M™ DBI-SALA® and Protecta® Fall Protection systems and components
Enable workers to secure tools and accessories while working at height
Multiple materials, closure systems, and attachment point options designed for a variety of applications

Typical properties

Brands
DBI-SALA®
Case Quantity
1
Connected Safety ID Equipped
No
Manufacturing Origin
Taiwan
Net Weight (Metric)
0.22 kg
Product Color
Brown
Product Type
Small Parts Pouch - Canvas Camo
Recommended Industry
Construction, General Industrial,

Dimensions and Classifications

Overall Height (Metric)
82.55 mm
Overall Length (Metric)
285.75 mm

3M™ DBI-SALA® Parts Pouch, Canvas Orange 1500121, Small, 1 EA

3M Product Number 1500121 3M ID 7100214256 UPC 00852684932296

Details

Compatible with 3M™ DBI-SALA® and Protecta® Fall Protection systems and components

Enable workers to secure tools and accessories while working at height

Multiple materials, closure systems, and attachment point options designed for a variety of applications

Typical properties

Brands

DBI-SALA®

Case Quantity

1

Connected Safety ID Equipped

No

Manufacturing Origin

Taiwan

Net Weight (Metric)

0.22 kg

Product Color

Orange

Product Type

Small Parts Pouch - Canvas Orange

Recommended Industry

Construction, General Industri

Dimensions and Classifications

Overall Height (Metric)

67.31 mm

Overall Length (Metric)

286.26 mm

3M™ DBI-SALA® Parts Pouch, Canvas Black, Extra Deep 1500123, Small

3M Product Number 1500123 3M ID 7100157156 UPC 00852684932357

Details

Compatible with 3M™ DBI-SALA® and Protecta® Fall Protection systems and components

Enable workers to secure tools and accessories while working at height

Multiple materials, closure systems, and attachment point options designed for a variety of applications

Typical properties

Brands

DBI-SALA®

Case Quantity

1

Connected Safety ID Equipped

No

Manufacturing Origin

Taiwan

Net Weight (Metric)

0.25 kg

Product Color

Black

Product Type

Small Parts Pouch

Recommended Industry

Construction, General Industrial, Mining, Oil &

Dimensions and Classifications

Overall Height (Metric)

63.5 mm

Overall Length (Metric)

403.86 mm

3M™ Tool Pouch with D-ring and Retractors 1500125, Canvas, Black, 7.5 in x 11 in

3M Product Number 1500125 3M ID 7010595550 UPC 00852684932418

Details

Compatible with 3M™ DBI-SALA® and Protecta® Fall Protection systems and components

Enable workers to secure tools and accessories while working at height

Multiple materials, closure systems, and attachment point options designed for a variety of applications

Typical properties

Brands

DBI-SALA®

Case Quantity

1

Connected Safety ID Equipped

No

Dimensions

7.00 x 5.00 x 10.00 inch

Manufacturing Origin

Taiwan

Net Weight (Metric)

0.61 kg

Product Type

Tool Pouch with D-Ring and Retractors (2)

Recommended Industry

Constru

Dimensions and Classifications

Overall Height (Metric)

58.42 mm

Overall Length (Metric)

285.75 mm

3M™ DBI-SALA® Long Safe Bucket 100 lb. Load Rated Hook and Loop Canvas

1500137, 1 ea

3M Product Number 1500137 3M ID 7100220234 UPC 00852684934764

Details

Compatible with 3M™ DBI-SALA® and Protecta® Fall Protection systems and components

Enable workers to secure tools and accessories while working at height

Multiple materials, closure systems, and attachment point options designed for a variety of applications

Typical properties

Brands

DBI-SALA®

Case Quantity

1

Connected Safety ID Equipped

No

Manufacturing Origin

China

Net Weight (Metric)

2.47 kg

Product Color

Black, Yellow

Product Type

Long Safe Bucket Hook & Loop Canvas

Recommended Industry

Construction, General

Dimensions and Classifications

Overall Height (Metric)

2311.4 mm

Overall Length (Imperial)

6 ft

Overall Length (Metric)

241.3 mm

3M™ Spill Control Long Safe Bucket with Hook and Loop Closure 1500138, 100 lb Capacity, Canvas, 120 in

3M Product Number 1500138 3M ID 7100312708 UPC 00852684934788

Details

Compatible with 3M™ DBI-SALA® and Protecta® Fall Protection systems and components

Enable workers to secure tools and accessories while working at height

Multiple materials, closure systems, and attachment point options designed for a variety of applications

Typical properties

Brands

DBI-SALA®

Case Quantity

1

Connected Safety ID Equipped

No

Manufacturing Origin

China

Net Weight (Metric)

2.47 kg

Product Color

Black, Yellow

Product Type

Long Safe Bucket Hook & Loop Canvas

Recommended Industry

Construction, General

Dimensions and Classifications

Overall Height (Metric)

222.25 mm

Overall Length (Imperial)

10 ft

Overall Length (Metric)

3098.8 mm

3M™ Spill Control Hard-Body Safe Bucket Insert with Integrated Pockets 1500141

3M Product Number 1500141 3M ID 7100260276 UPC 00840779112333

Details

Compatible with 3M™ DBI-SALA® and Protecta® Fall Protection systems and components

Enable workers to secure tools and accessories while working at height

Multiple materials, closure systems, and attachment point options designed for a variety of applications

Typical properties

Brands

DBI-SALA®

Case Quantity

1

Connected Safety ID Equipped

No

Manufacturing Origin

China

Net Weight (Metric)

0.59 kg

Product Color

Black, Yellow

Product Type

Hard Body Safe Bucket Insert with Pockets

Recommended Industry

Construction, Ge

Dimensions and Classifications

Overall Height (Metric)

2.16 mm

Overall Length (Metric)

263.53 mm

3M™ Spill Control 2:1 Safe Bucket with Drawstring Closure 1500182, 100 lb Capacity, Canvas, 12.5 in dia x 16 in

3M Product Number 1500182 3M ID 7012818198 UPC 00840779173761

Details

Compatible with 3M™ DBI-SALA® and Protecta® Fall Protection systems and components
Enable workers to secure tools and accessories while working at height
Multiple materials, closure systems, and attachment point options designed for a variety of applications

Typical properties

Brands
DBI-SALA®
Case Quantity
1
Connected Safety ID Equipped
No
Net Weight (Imperial)
4.83 lb
Net Weight (Metric)
2.19 kg
Product Color
Black, Yellow
Recommended Industry
Construction, Transportation, Utilities, Wind Energy
Specifications M

Dimensions and Classifications

Overall Diameter (Imperial)
12.5 in
Overall Diameter (Metric)
31.75 cm
Overall Height (Imperial)
16 in
Overall Height (Metric)
40.64 cm

3M™ DBI-SALA® Parts Pouch, Vinyl Yellow 1500122, Small, 1 EA

3M Product Number 1500122 3M ID 7100214257 UPC 00852684932333

Details

Compatible with 3M™ DBI-SALA® and Protecta® Fall Protection systems and components

Enable workers to secure tools and accessories while working at height

Multiple materials, closure systems, and attachment point options designed for a variety of applications

Typical properties

Brands

DBI-SALA®

Case Quantity

1

Connected Safety ID Equipped

No

Manufacturing Origin

Taiwan

Net Weight (Metric)

0.27 kg

Product Color

Yellow

Product Type

Small Parts Pouch - Vinyl Yellow

Recommended Industry

Construction, General Industria

Dimensions and Classifications

Overall Height (Metric)

74.93 mm

Overall Length (Metric)

541.02 mm

3M™ Tool Pouch with D-ring 1500127, Canvas, Black, 8.75 in x 13 in

3M Product Number 1500127 3M ID 7012596550 UPC 00852684932487

Details

Compatible with 3M™ DBI-SALA® and Protecta® Fall Protection systems and components

Enable workers to secure tools and accessories while working at height

Multiple materials, closure systems, and attachment point options designed for a variety of applications

Typical properties

Brands

DBI-SALA®

Case Quantity

1

Connected Safety ID Equipped

No

Dimensions

8.50 x 5.00 x 13.00 inch

Product Color

Black

Product Type

Tool Pouch Extra Deep with D-Ring

Recommended Industry

Construction, General Industrial, Mining, Oil & Gas,

3M™ Spill Control Safe Bucket with Drawstring Closure 1500133, 100 lb Capacity, Canvas, 12.5 in dia x 15 in

3M Product Number 1500133 3M ID 7100270185 UPC 00852684930254

Details

Compatible with 3M™ DBI-SALA® and Protecta® Fall Protection systems and components

Enable workers to secure tools and accessories while working at height

Multiple materials, closure systems, and attachment point options designed for a variety of applications

Typical properties

Brands

DBI-SALA®

Case Quantity

1

Connected Safety ID Equipped

No

Manufacturing Origin

China

Net Weight (Metric)

0.45 kg

Product Color

Black, Yellow

Product Type

Safe Bucket Drawstring Canvas

Recommended Industry

Construction, General Indust

Dimensions and Classifications

Overall Height (Metric)

374.65 mm

Overall Length (Metric)

323.85 mm

3M™ Utility Tool Pouch with Zipper Closure 1500130, Canvas, White

3M Product Number 1500130 3M ID 7100258403 UPC 00852684935112

Details

Compatible with 3M™ DBI-SALA® and Protecta® Fall Protection systems and components

Enable workers to secure tools and accessories while working at height

Multiple materials, closure systems, and attachment point options designed for a variety of applications

Typical properties

Brands

DBI-SALA®

Case Quantity

1

Connected Safety ID Equipped

No

Dimensions

11.00 x 5.00 x 10.50 inch

Net Weight (Imperial)

1.15 lb

Net Weight (Metric)

0.52 kg

Product Color

White

Product Type

Utility Pouch with Zipper

Recommended Industry

3M™ DBI-SALA® Safe Bucket 100 lb. Load Rated Hook and Loop Canvas 1500134, 1 EA

3M Product Number 1500134 3M ID 7100209335 UPC 00852684930292

Details

Compatible with 3M™ DBI-SALA® and Protecta® Fall Protection systems and components

Enable workers to secure tools and accessories while working at height

Multiple materials, closure systems, and attachment point options designed for a variety of applications

Typical properties

Brands

DBI-SALA®

Case Quantity

1

Connected Safety ID Equipped

No

Manufacturing Origin

China

Net Weight (Metric)

1.83 kg

Product Color

Black, Yellow

Product Type

Safe Bucket Hook and Loop Canvas

Recommended Industry

Construction, General Ind

Dimensions and Classifications

Overall Height (Metric)

147.32 mm

Overall Length (Metric)

448.31 mm

3M™ Spill Control 5-Gallon Safe Bucket with Hook and Loop Closure 1500135, 100 lb Capacity, Canvas

3M Product Number 1500135 3M ID 7100237394 UPC 00852684934801

Details

Compatible with 3M™ DBI-SALA® and Protecta® Fall Protection systems and components
Enable workers to secure tools and accessories while working at height
Multiple materials, closure systems, and attachment point options designed for a variety of applications

Typical properties

Brands
DBI-SALA®
Case Quantity
1
Connected Safety ID Equipped
No
Manufacturing Origin
China
Net Weight (Metric)
2.4 kg
Product Color
Black, Yellow
Product Type
5 gal Safe Bucket Hook & Loop Canvas
Recommended Industry
Construction, General

Dimensions and Classifications

Overall Height (Metric)
187.27 mm
Overall Length (Metric)
539.75 mm

3M™ DBI-SALA® ExoFit™ STRATA™ Tool Bag Hanger for Harness 9512724, 40 lb Capacity

3M Product Number 9512724 3M ID 7100310706

Details

Compatible with 3M™ DBI-SALA® and Protecta® Fall Protection systems and components

Enable workers to secure tools and accessories while working at height

Multiple materials, closure systems, and attachment point options designed for a variety of applications

Typical properties

Brands

DBI-SALA®

Case Quantity

1

Connected Safety ID Equipped

No

Dimensions

(6.25x3.62x)Unknown

Net Weight (Imperial)

0.1 lb

Net Weight (Metric)

0.04 kg

Product Color

Black

Product Type

Tool Bag Hanger for Harness

Recommended Industry

Con

3M™ PROTECTA® PRO™ Aluminum Tripod AK105A, 1 EA

Part Number AK105A 3M Product Number AK105A 3M ID 7100188839

Details

- 8 ft. (2.4 m) aluminum tripod
- Telescoping adjustable locking legs
- Slip-resistant rubber tripod feet
- Safety leg support chain
- Integrated 5,000 lb. (22 kN) anchor point
- Durable, lightweight, and portable aluminum design
- Recommended for use in construction and general industrial applications
- The Protecta 3-way SRL with emergency retrieval or winch attach easily to mounting bracket

Typical properties

- Brands
- PROTECTA®
- Case Quantity
- 1
- Connected Safety ID Equipped
- No
- Install Type
- Portable
- Maximum Base Radius (Imperial)
- 8.75 ft
- Maximum Base Radius (Metric)
- 2.66 m
- Minimum Base Radius (Imperial)
- 5 ft
- Minimum Base Radius (Metric)
- 1.52 m
- Net W

3M™ Fit Test Adapter 601, 1 EA/Case

3M Product Number 601 3M ID 7000001945 UPC 00051138290184

Details

Use to conduct quantitative fit testing (QNFT) on 3M™ Reusable Respirators with certain sampling instruments, such as a TSI® PortaCount® Respirator Fit Tester Designed to be used with the 3M™ Half Facepieces 6000, 6500/6500QL and 7500 Series, and Full Facepieces 6000, FF-400 and 7800 Series

Quantitative fit testing is required to obtain an OSHA assigned protection factor (APF) of 50 for full facepieces in negative-pressure air-purifying mode

Fit tests should be performed per OSHA Regulation 29 CFR 1910.134 - Appendix A

Package contents: adaptor, plastic tubing, suction cups, and a retainer clip
For workplace/occupational use only

Typical properties

Accessories

No

Brands

3M™

Case Quantity

1/pack

Clip-on Welding Shield

No

Product Series

6000, 7000

Product Type

Fit Test Adapter

Purpose

Parts and Accessories

Spare Parts

No

Specifications Met

CE

Test Format

Quantitative

eClass 14 Clas

3M™ DBI-SALA® Rollgliss™ RPD Rescue Positioning Device, 4:1 Ratio 3602050, 1 EA

Part Number 3602050 3M Product Number 3602050 3M ID 7100204312

Details

Designed for raising, lowering, and positioning
Manual control for ascent and descent
Pre-rigged system with speed-sensing braking mechanism
High strength corrosion resistant construction

Typical properties

Brands
DBI-SALA®
Case Quantity
1
CoWorker Controlled Ascent
Yes
CoWorker Controlled Descent
Yes
Connected Safety ID Equipped
Yes
Descent Type
Vertical
Dimensions
11.40x3.80x25.40cm
Lifeline Material
Kernmantle, Braided Polyester Cover with

Dimensions and Classifications

Overall Length (Imperial)
15 ft
Overall Length (Metric)
15 m

3M™ DBI-SALA® Rollgliss™ RPD 4:1 Ratio Rescue Positioning Device Kit 3602150, 3/8 in Nylon Kernmantle Rope, 150 ft

Part Number 3602150 3M Product Number 3602150 3M ID 7012819485

Details

Designed for raising, lowering, and positioning
Manual control for ascent and descent
Pre-rigged system with speed-sensing braking mechanism
High strength corrosion resistant construction

Typical properties

Brands
DBI-SALA®
Case Quantity
1
CoWorker Controlled Ascent
Yes
CoWorker Controlled Descent
Yes
Connected Safety ID Equipped
Yes
Descent Type
Vertical
Dimensions
4.50x1.50x10.00in
Lifeline Material
Kernmantle, Braided Polyester Cover with N

Dimensions and Classifications

Overall Length (Imperial)
150 ft
Overall Length (Metric)
45 m

3M™ DBI-SALA® Rollgliss™ RPD 4:1 Ratio Rescue Positioning Device Kit 3602200, 3/8 in Nylon Kernmantle Rope, 200 ft

Part Number 3602200 3M Product Number 3602200 3M ID 7012819486

Details

Designed for raising, lowering, and positioning
Manual control for ascent and descent
Pre-rigged system with speed-sensing braking mechanism
High strength corrosion resistant construction

Typical properties

Brands
DBI-SALA®
Case Quantity
1
CoWorker Controlled Ascent
Yes
CoWorker Controlled Descent
Yes
Connected Safety ID Equipped
Yes
Descent Type
Vertical
Dimensions
4.50x1.50x10.00in
Lifeline Material
Kernmantle, Braided Polyester Cover with N

Dimensions and Classifications

Overall Length (Imperial)
200 ft

3M™ DBI-SALA® Rollgliss™ RPD Rescue Positioning Device, 4:1 Ratio 3602100, 1 EA

Part Number 3602100 3M Product Number 3602100 3M ID 7100204311

Details

Designed for raising, lowering, and positioning
Manual control for ascent and descent
Pre-rigged system with speed-sensing braking mechanism
High strength corrosion resistant construction

Typical properties

Brands
DBI-SALA®
Case Quantity
1
CoWorker Controlled Ascent
Yes
CoWorker Controlled Descent
Yes
Connected Safety ID Equipped
Yes
Descent Type
Vertical
Dimensions
11.40x3.80x25.40cm
Lifeline Material
Kernmantle, Braided Polyester Cover with

Dimensions and Classifications

Overall Length (Imperial)
100 ft
Overall Length (Metric)
30 m

3M™ DBI-SALA® Rollgliss™ RPD 4:1 Ratio Rescue Positioning Device Kit 3602300, 3/8 in Nylon Kernmantle Rope, 300 ft

Part Number 3602300 3M Product Number 3602300 3M ID 7012819488

Details

Designed for raising, lowering, and positioning
Manual control for ascent and descent
Pre-rigged system with speed-sensing braking mechanism
High strength corrosion resistant construction

Typical properties

Brands
DBI-SALA®
CoWorker Controlled Ascent
Yes
CoWorker Controlled Descent
Yes
Connected Safety ID Equipped
Yes
Lifeline Material
Kernmantle, Braided Polyester Cover with Nylon Filament Core
Maximum Number of Users
Two
Product Color
Blue
Pr

Dimensions and Classifications

Overall Length (Imperial)
300 ft

3M™ DBI-SALA® Lad-Saf™ X3 Detachable Cable Sleeve 6160054, 9.5MM

Part Number 6160054 3M Product Number 6160054 3M ID 7100188819

Details

Sleeve/Traveler for 3M™ DBI-SALA® Lad-Saf™ 9.5 mm. (3/8 in.) cable vertical safety system

Approved for use on galvanized or stainless steel 9.5 mm (3/8 in.) cable vertical safety system

Mobile hands-free design helps follow the user for added climbing protection

Installs and detaches anywhere along the vertical lifeline

Dual-independent locking mechanism

Laser-cut stainless steel built-in energy absorber and fall indicator

Manufactured from stainless steel which helps to resist corrosion in harsh conditions

Can be used on various installations of 3M™ DBI-SALA® Lad-Saf™ 9.5 mm. (3/8 in.) vertical cable systems

Portable and compact design allows for transportation to and from the job site

Equipped with 3M™ Connected Safety ID (CSID)

Equipped with anti-inversion features to reduce the possibility of misuse

Typical properties

Attachment Type

None

Brands

DBI-SALA®

Carabiner/Hook Material

Zinc Plated Steel

Case Quantity

1

Connected Safety ID Equipped

Yes

Dimensions

4.7 in x 1.3 in x 6 in

Install Type

Temporary

Maximum Number of Users

One

Net Weight (Imperial)

2.

3M™ DBI-SALA® Temporary Rebar/Shear Stud Horizontal Lifeline Intermediate Retro-Fit Kit 7400054

Part Number 7400054 3M Product Number 7400054 3M ID 7012820228

Details

Includes a rebar/shear stud base and pass-through bracket; stanchions and lifelines are sold separately

Compatible with single-span and multi-span lifeline configurations

Single-span systems hold up to 2 workers; multi-span systems hold up to 6 workers

Horizontal lifelines offer workers exceptional mobility on the job

Portable design is durable, yet lightweight, for easy transport

This safety equipment is intended for use with additional personal protective equipment (PPE)

Recommended for use in multiple industries including construction, facilities, general manufacturing, heavy infrastructure, and more

Typical properties

Anchor Install Type

Reusable

Brands

DBI-SALA®

Case Quantity

1

Connected Safety ID Equipped

No

Install Type

Temporary/Portable

Material

Zinc Plated Steel

Maximum Number of Workers

2 Per Span, 6 Total

Product Series

SecuraSpan™

Product Type

3M™ DBI-SALA® SecuraSpan™ Pour-in-Place HLL Concrete Sleeve 7400201, 1 ea

Part Number 7400201 3M Product Number 7400201 3M ID 7100220293

Details

Compatible with single-span and multi-span lifeline configurations
Lightweight, portable design for easy transport
Recommended for use in multiple industries including construction, facilities, general manufacturing, heavy infrastructure, and more
Single-span systems hold up to 2 workers; multi-span systems hold up to 6 workers
Designed for use in 3M™ DBI-SALA® Temporary Cable Horizontal Lifeline Pour-in-Place Post Systems
This safety equipment is intended for use with additional personal protective equipment (PPE)

Typical properties

Brands
DBI-SALA®
Case Quantity
1
Connected Safety ID Equipped
No
For Use With
3M™ DBI-SALA® SecuraSpan™ Pour-in-Place/Fasten-in-Place HLL system
Install Type
Temporary/Portable
Lifeline Material
Order separately
Maximum Number of Workers
2 Pe

3M™ DBI-SALA® Flexiguard™ Counterweight Rail Fixed Height Anchor System with Concrete 8517763, 2 User, 22 ft High, 42 ft Wide

3M Product Number 8517763 3M ID 7012777009

Details

Counterweighted overhead rail fall protection system

Aluminum and steel construction

Complete hardware provided

Portable with use of a forklift

Includes four steel leveling jacks; built-in slope indicators available as option

Recommended for a variety of applications within the transportation, construction, utilities, and mining industries

3M™ DBI-SALA® FlexiGuard™ Systems are available in multiple sizes, both fixed and adjustable heights

One part of your fall protection system; intended for use with other personal protective equipment (PPE) including (but not limited to) harnesses and self-retracting lifelines

Specialized installation and training available

Typical properties

Brands

DBI-SALA®

Case Quantity

1

Connected Safety ID Equipped

Yes

Install Type

Temporary/Portable

Maximum Height (Imperial)

23.55 ft

Maximum Height (Metric)

7.18 m

Maximum Number of Users

Two

Net Weight (Imperial)

3980 lb

Product Color

Si

Dimensions and Classifications

Overall Width (Imperial)

42 ft

Overall Width (Metric)

12.8 m

3M™ Peltor™ Optime™ 98 Cap-Mount Earmuffs, Hearing Conservation H9P3E 10 EA/Case

3M Product Number H9P3E 3M ID 7000002326 UPC 10093045080936

Details

For noise levels up to 98 dBA
Universal mounting attachment fits most hard hats
Earcup pivot points tilt for optimum comfort and efficiency
Ultra light with liquid/foam filled earmuff cushions
Noise Reduction Rating (NRR)*: 23 dB. CSA Class A

Typical properties

Attenuation Rating
23.0 Decibel
Bluetooth
No
Brands
PELTOR™
Dielectric
No
Earmuff Style
Hard Hat Attached
Electrically Insulated
No
Hearing Protection Style
Hard Hat Attached
Hearing Protection Type
cap-mount earmuffs
Material
ABS
Metal

3M™ PELTOR™ Optime™ 98 Earmuffs H9A, Over-the-Head, 10 EA/Case

Part Number 08091 3M Product Number H9A 3M ID 7000009670

Details

Recommended for TWA noise exposures up to 98 dBA
Stainless steel headband distributes weight for low pressure fit
Earcup pivot points tilt for comfort that adjusts to individual wearers
Noise Reduction Rating (NRR) 25 decibels
Earcups with liquid and foam filled cushions offer comfort for long wear and optimum seal

Typical properties

Attenuation Rating
25.0 Decibel
Bluetooth
No
Brands
PELTOR™
Case Quantity
10
Corded
No
Dielectric
No
Earmuff Style
Over the Head
Electrically Insulated
No
Hearing Protection Style
Over-the-Head
Material
ABS
Metal Detectable
No
Moisture

**3M™ E-A-RLINK™ Foam Eartips 3C 420-2028-5, with Black Tube,
Large Size,
Yellow, 24 EA/Case**

3M Product Number 420-2028 3M ID 7010384795 UPC 10080529510065

Details

Designed for use with 3M™ E-A-RTONE™ 3A and 5A Insert Earphone
Disposable
3M PSD products are for occupational use only

Typical properties

Brands
E-A-R™
Case Quantity
24
Hearing Protection Style
Probed for Fit Testing
Product Series
E-A-RLINK
Product Type
Foam Eartip
Shape
Cylinder

**3M™ E-A-RLINK™ Foam Plug-With-Hole Eartips 5LS 420-2067, 3/4
Inch
Height, Yellow, 500 EA/Case**

3M Product Number 420-2067 3M ID 7010296240 UPC 10080529191264

Details

Designed for use with 3M™ E-A-RTONE™ 3A and 5A Insert Earphone
Disposable
3M PSD products are for occupational use only

Typical properties

Brands
E-A-R™
Case Quantity
500
Corded
No
Hearing Protection Style
Probed for Fit Testing
Product Series
E-A-RLINK
Product Type
Earplugs
Shape
Cylinder

3M™ Versaflo™ Easy Clean Belt TR-627/37345(AAD), for TR-600/800 PAPR

Part Number 37345 3M Product Number TR-627 3M ID 7100035833

Details

Comfortable due to ergonomic design
Easy to use
Designed to make cleaning easy

Typical properties

Brands
Versaflo™
Case Quantity
1/pack
Compatible With
3M™ Versaflo™ TR-600 Series PAPR, 3M™ Versaflo™ TR-800 Series PAPR
Hazard Type
Silica
Product Color
Gray
Product Series
TR-600, TR-800
Product Type
Belt
Recommended Application
Composite

3M™ Versaflo™ High Durability Belt TR-626, for TR-600/800 PAPR, 1 EA/Case

3M Product Number TR-626 3M ID 7100035831 UPC 00051131373433

Details

Comfortable due to ergonomic design
Easy to use
Durable construction

Typical properties

Brands
Versaflo™
Case Quantity
1/case
Compatible With
3M™ Versaflo™ TR-600 Series PAPR
Hazard Type
Silica
Product Color
Gray
Product Series
TR-600
Product Type
Belt
Recommended Application
Composite Finishing, Final Finish, Paint Preparatio

3M™ Versaflo™ Belt Extender TR-627X/37346(AAD), for TR-627 Easy Clean Belt

Part Number 37346 3M Product Number TR-627X 3M ID 7100035834

Details

Comfortable due to ergonomic design
Easy to use
Extendable

Typical properties

Brands
Versaflo™
Case Quantity
1/pack
Compatible With
3M™ Versaflo™ TR-600 Series Belt, 3M™ Versaflo™ TR-800 Series Belt
Hazard Type
Silica
Product Color
Gray
Product Series
TR-600, TR-800
Product Type
Belt
Recommended Industry
Animal proce

3M™ Portable Compressed Air Filter and Reg Panel 256-02-00, 50 cfm, 4 outlets, w/Carbon Monoxide Filtration and Monitor 1 EA/Case

Part Number 66307 3M Product Number 256-02-00 3M ID 7100009683

Details

This panel is a four outlet panel that filters and monitors carbon monoxide (CO) It is packaged in a protective carrying case for total portability

Typical properties

Battery Type
Alkaline 9V
Brands
3M™
CFM Capacity per Minute
50 CFM
Case Quantity
10/pack
Compatible Respirator
256-02-01
Intrinsically Safe
No
Number of Outlets
4
Product Color
Blue
Product Series
Supplied Air
Product Type
Filter
Recom

3M™ Full Facepiece Reusable Respirator 7800S-L, Large, Silicone 1 EA/Case

3M Product Number 7800S-L 3M ID 7000126201 UPC 00051138542597

Details

Recommended for use in multiple industries including construction, general manufacturing, heavy infrastructure, industrial maintenance, mining, oil and gas, welding, and more

Meets the requirements of ANSI Z87.1-2003 standard for eye and face protection

Silicone face seal helps provide comfort and durability, and is easy to clean

Six-strap harness helps provide a secure comfortable fit

Use with 3M™ Particle Filters 2000, 2200, 7000, or 5000 Series to help filter certain particulates

Use with 3M 6000 Series Gas/Vapor Cartridges to help filter a broad range of gases and vapors

Use with 3M 6000 Series Combination Cartridges to help filter particulates in addition to gases and vapors

Compatible with 3M™ TR-600 and TR-800 powered air and Dual Airline supplied air systems against a variety of gases, vapors, and particulate hazards

For workplace/occupational use only

Typical properties

Accessories

Yes

Assigned Protection Factor

10 Qualitative Fit Test, 50 Quantitative Fit Test

Brands

3M™

Cartridge or Filter Included

No

Case Quantity

1/case

Clip-on Welding Shield

Yes

Compatible with 3M™ PAPR Systems

Yes

Compatible with 3M™

3M™ Full Facepiece Reusable Respirator 7800S-M, Medium, Silicone 1 EA/Case

3M Product Number 7800S-M 3M ID 7000002045 UPC 00051138542580

Details

Recommended for use in multiple industries including construction, general manufacturing, heavy infrastructure, industrial maintenance, mining, oil and gas, welding, and more

Meets the requirements of ANSI Z87.1-2003 standard for eye and face protection

Silicone face seal helps provide comfort and durability, and is easy to clean

Six-strap harness helps provide a secure comfortable fit

Use with 3M™ Particle Filters 2000, 2200, 7000, or 5000 Series to help filter certain particulates

Use with 3M 6000 Series Gas/Vapor Cartridges to help filter a broad range of gases and vapors

Use with 3M 6000 Series Combination Cartridges to help filter particulates in addition to gases and vapors

Compatible with 3M™ TR-600 and TR-800 powered air and Dual Airline supplied air systems against a variety of gases, vapors, and particulate hazards

For workplace/occupational use only

Typical properties

Accessories

Yes

Assigned Protection Factor

10 Qualitative Fit Test, 50 Quantitative Fit Test

Brands

3M™

Cartridge or Filter Included

No

Case Quantity

1/pack

Clip-on Welding Shield

Yes

Compatible with 3M™ PAPR Systems

Yes

Compatible with 3M™

3M™ Universal Spectacle Kit 102, 1 ea/Case

Part Number 102 3M Product Number 102 3M ID 7100254233

Details

Spectacle Kit for 3M™ Full Facepiece FF-400 and 6000 series
Permits wearer to use corrective lenses and to make position adjustment that is most comfortable
1 each per case
Easy installation
For occupational use only

Typical properties

Accessories
Yes
Brands
3M™
Clip-on Welding Shield
No
Compatible Respirator
6000 Series, FF-400 Series, FF-800 Series
Compatible with 3M™ PAPR Systems
Yes
Compatible with 3M™ Supplied Air System
Yes
Compatible with Welding Shield
No
Cool Flow

3M™ Filter Retainer 501, 100 EA/Case

3M Product Number 501 3M ID 7100211073 UPC 50051138176681

Details

Approved 3M system component

Designed to hold 3M Particulate Filter 5N11 and 5P71/07194 (AAD) (sold separately)

Component works with 3M Respirator 5000 Series, 3M Cartridges 6000 Series and 3M™ Filter Adapter 603

Color: Translucent white

Measures 4" high x 8.5" long x 4.5" wide

Refer to the Filter/Cartridge User Instructions for further information

Typical properties

Accessories

Yes

Brands

3M™

Case Quantity

20/pack

Compatible Respirator

6000 Series, 6500QL Series, 7500 Series, FF-400 Series

Maintenance Free

Yes

Material

Polypropylene

Product Color

Translucent White

Product Type

Filter Retainer

Recommen

3M™ Rugged Comfort Half Facepiece Reusable Respirator 6502/49489, Medium, 10 EA/Case

3M Product Number 6502 3M ID 7000128238 UPC 50051131494898

Details

Recommended industries include construction, general manufacturing, heavy infrastructure, industrial maintenance, mining, oil and gas, transportation, and more

Use with 3M™ Particle Filters 2000, 2200, 7000, or 5000 Series to filter certain particulates

Use with 3M 6000 Series Gas/Vapor Cartridges to help filter a broad range of gases and vapors

Use with 3M 6000 Series Combination Cartridges to help filter particulates in addition to gases and vapors

Compatible with 3M™ TR-600 and TR-800 powered air purifying respirators and Dual Airline supplied air systems against a variety of gases, vapors, and particulate hazards

Silicone face seal keeps its shape even in hot work conditions

Low-profile half facepiece design is compatible with many welding and grinding shields

For workplace/occupational use only

Typical properties

Accessories

No

Aerosol Type

Oil and Non-Oil

Assigned Protection Factor

10

Brands

3M™

Case Quantity

10/case

Clip-on Welding Shield

No

Compatible With

Line Compressed Air System SA Series

Compatible with 3M™ PAPR Systems

No

Compatible with 3

3M™ Speedglas™ Hard Hat Adapter 9100 FX 06-0614-00NR, for 9100 FX Welding Helmets, No Hard Hat, 1 EA/Case

3M Product Number 06-0614-00NR 3M ID 7000148536 UPC 00051141561066

Details

Adjustable adaptor attaches 3M™ Speedglas™ Welding Helmet 9100 FX to most hard hats

All mounting hardware included

Allows for easy integration of headcover for welding

One adapter per case

Applications include assembly, facility maintenance, grinding, machine operations, sanding, and welding

For use in the construction, heavy infrastructure, and industrial maintenance industries

Typical properties

Brands

Speedglas™

Case Quantity

1

Compatible Welding Helmet

9100 FX Welding Helmets

Features

Head Protection

Headgear Type

Hard Hats

Product Color

Black

Product Type

Hard Hat Adapter

Recommended Application

Assembly, Facility Maintenance, G

3M™ Speedglas™ G5-01 Head Suspension Assembly, 46-0400-51, 1 EA/Case

3M Product Number 46-0400-51 3M ID 7100259734 UPC 00638060433386

Details

Adjustable adaptor attaches 3M™ Speedglas™ Welding Helmet 9100 and 9100 FX to most hard hats
All mounting hardware included
Allows for easy integration of headcover for welding
One adapter per case
Applications include assembly, facility maintenance, grinding, machine operations, sanding, and welding
For use in the construction, heavy infrastructure, and industrial maintenance industries

Typical properties

Brands
Speedglas™
Case Quantity
1
Compatible Welding Helmet
G5-01 Welding Helmets
Product Color
Black
Product Series
G5
Product Type
Suspension Assembly
Recommended Application
Grinding, Metal Processing, Metal Repair, Welding
Recommended In

3M™ Speedglas™ 100/9002 Hard Hat Adapter 07-0014-00NR, for 3M™ Speedglas™ 100/9002 Welding Helmets, No Hard Hat

3M Product Number 07-0014-00NR 3M ID 7100291856 UPC 00638060434789

Details

Adjustable adaptor attaches 3M™ Speedglas™ Welding Helmet 9100 and 9100 FX to most hard hats
All mounting hardware included
Allows for easy integration of headcover for welding
One adapter per case
Applications include assembly, facility maintenance, grinding, machine operations, sanding, and welding
For use in the construction, heavy infrastructure, and industrial maintenance industries

Typical properties

Brands
Speedglas™
Case Quantity
1
Compatible Welding Helmet
100 Series, 9002NC
Features
Head Protection
Headgear Type
Hard Hats
Product Color
Black
Product Type
Hard Hat Adapter
Recommended Application
Assembly, Facility Maintenance, Grindi

3M™ DBI-SALA® Concrete Parapet Anchor 8523178, 1 ea

Part Number 8523178 3M Product Number 8523178 3M ID 7100220317

Details

Installs onto multiple widths of concrete parapets
Corrosion-resistant steel construction for durability
Features an integrated D-ring tie-off point
Low-profile design stays out of the way as you work
Recommended for use in the construction, general industrial, mining, and oil and gas industries
Meets the requirements for OSHA 1910.140 and OSHA 1926.502
This safety equipment is designed for use with additional personal protective equipment (PPE)
Compatible with various personal fall arrest systems except horizontal lifelines

Typical properties

Anchor Install Type
Reusable
Anchor Type
D-ring Anchorage Plate
Attachment Type
Clamp
Brands
DBI-SALA®
Case Quantity
1
Connected Safety ID Equipped
No
Dimensions
22.00x2.50x15.00in
Install Type
Reusable
Material
Galvanized Steel
Product

3M™ DBI-SALA® Confined Space Adjustable Ladder Bracket 8518506

Part Number 8518506 3M Product Number 8518506 3M ID 7012820785

Details

For use with 8518507 and 8518508 aluminum ladders
Attaches ladder to confined space system
Lightweight, corrosion resistant aluminum construction

Typical properties

Brands

DBI-SALA®

Case Quantity

1

Connected Safety ID Equipped

No

Net Weight (Imperial)

29 lb

Net Weight (Metric)

13.2 kg

Product Color

Silver

Recommended Industry

Construction, General Industrial, Mining, Oil & Gas, Transportation, Utilities,

3M™ Respirator Cleaning Wipe 504/07065(AAD), 500 EA/Case

Part Number 07065 3M Product Number 504 3M ID 7000001938

Details

Moist towelettes clean dirt and perspiration off facepiece respirators
Individually packaged and sealed to ensure uncompromised sanitary quality
Disposable, one-time-use for convenience
Convenient for respirator hygiene and sanitary protection between uses
Alcohol-free towelettes contain no alcohol or harsh chemical

Typical properties

Accessories

No

Brands

3M™

Case Quantity

1/pack

Clip-on Welding Shield

No

Compatible Respirator

6500QL Series

Compatible with 3M™ PAPR Systems

No

Compatible with 3M™ Supplied Air System

No

Compatible with Welding Shield

No

Cool Flow™ Exhala

3M™ DBI-SALA® Remote Power Tagline 8102101, 110 Volt, Galvanized Cable, 100 ft

Part Number 8102101 3M Product Number 8102101 3M ID 7012776992

Details

Remote power tagline system for self retracting lifeline
100 ft. (30.5 m) 3/16" (5 mm) galvanized lifeline
High speed 75 ft. (22.9 m) per minute travel distance
Attach up to 3 self retracting lifelines
Wireless and corded controls included
Heavy-duty construction
Automatic shut off
Operates on standard 110 volt power
Mounting brackets included

Typical properties

Brands
DBI-SALA®
Case Quantity
1
Connected Safety ID Equipped
No
Net Weight (Imperial)
96.8 lb
Net Weight (Metric)
43.9 kg
Product Color
Black, Yellow
Product Type
Remote Power Tagline for Self Retracting Lifeline
Recommended Industry
Const

3M™ Hex Head Cap Screw 9501215, Stainless Steel, 1/2 in-13 x 3 in

3M Product Number 9501215 3M ID 7100310339

Details

Bag sizes to accommodate user needs
Keep your fall protection equipment together
Keep your fall protection equipment stored away from dirt and debris

Typical properties

Brands
Railok 90™
Case Quantity
1
Connected Safety ID Equipped
No
Dimensions
200.00x230.00x230.00mm
For Use With
Harnesses
Product Color
Black
Product Type
Harness Laundry Wash Bag
Recommended Industry
Construction, General Industrial, Oil

3M™ DBI-SALA® Equipment Carrying and Storage Bag 9511597, 7.5 in x 6.5 in x 15.5 in

Part Number 9511597 3M Product Number 9511597 3M ID 7100311235

Details

Bag sizes to accommodate user needs
Keep your fall protection equipment together
Keep your fall protection equipment stored away from dirt and debris

Typical properties

Brands
DBI-SALA®
Case Quantity
1
Connected Safety ID Equipped
No
Dimensions
7.50x6.50x15.50in
Product Color
Blue
Product Type
Equipment Carrying & Storage Bag
Recommended Industry
Construction, General Industrial, Oil & Gas, Transportation, U

Dimensions and Classifications

Overall Length (Imperial)
12.5 in
Overall Length (Metric)
31.75 cm
Overall Width (Imperial)
7.5 in
Overall Width (Metric)
19.1 cm

3M™ PROTECTA® PRO™ Confined Space Pulley AK020A1, 1 ea

Part Number AK020A1 3M Product Number AK020A1 3M ID 7100220244

Details

Pulley for confined space entry
Routes winch/SRL lifeline
Aluminum and galvanized options available
Self closing/locking steel carabiner
Fits up to 1/2 in. (13 mm) lifelines
Sintered bronze bearings
Accommodates lifelines up to 1/2 in. (13 mm)

Typical properties

Brands
PROTECTA®
Carabiner/Hook Material
Zinc Plated Steel
Case Quantity
1
Connected Safety ID Equipped
No
Dimensions
3.50x1.30x5.10in
Product Color
Anodized Yellow, Yellow Zinc
Product Series
PRO™
Product Type
Confined Space Pulley
Recomm

3M™ DBI-SALA® Temporary Loop Rebar Horizontal Lifeline Stanchion with Base 7400045

Part Number 7400045 3M Product Number 7400045 3M ID 7012820224

Details

Base conveniently adjusts from the top of the beam to promote ease of use and safety

Portable design is durable, yet lightweight, for easy transport

Equipped with RFID

Designed for use with 3M™ DBI-SALA® HLL Rebar systems

Recommended for use in multiple industries including construction, general industrial, general manufacturing, and more

This safety equipment is intended for use with additional personal protective equipment (PPE)

Single-span systems hold up to 2 workers; multi-span systems hold up to 6 workers

Intended for use as a temporary horizontal lifeline system

Typical properties

Brands

DBI-SALA®

Case Quantity

1

Connected Safety ID Equipped

Yes

Install Type

Temporary/Portable

Lifeline Material

Order separately

Maximum Number of Workers

2 Per Span, 6 Total

Product Series

SecuraSpan™

Product Type

Loop Rebar HLL Stanch

3M™ Chin Strap H-114-2 2/Case

3M Product Number H-114-2 3M ID 7000052083 UPC 50051138660906

Details

For use with 3M™ Hoods H-Series

Typical properties

Brands

3M™

Compatible With

3M™ H-Series Headgear

Headgear Type

Hood

High Heat

No

Product Color

White

Product Series

H-Series

Product Type

Chinstrap

3M™ Versaflo™ Powered Air Purifying Respirator Unit TR-802N/94242(AAD), Intrinsically Safe 1 EA/Case

Part Number 94242 3M Product Number TR-802N 3M ID 7100150821

Details

Top of the line IS protection - The TR-800 is a PAPR blower rated at Division I for Classes I,II, and III under the most current UL standard (UL 60079, 6th Edition, 2013)

More options for more tasks - Choose from particulate filters or gas and vapor combination cartridges for protection in a variety of environments

Work with ease - Intuitive, colored touchpoints plus visual and audible low flow indicators help make the TR-800 easy to use

Work at your own speed - Multiple airflow rates put you in control of your comfort

When clean is critical - Easy-to-clean belt and disposable breathing tube covers save time and effort, paving the way for more productivity

Typical properties

Battery Life

4 - 8 Hours

Brands

Versaflo™

Case Quantity

1/case

Compatible With

3M™ Versaflo™ TR-800 Series PAPR

Intrinsically Safe

Yes

Mounting Type

Belt-mounted

Product Series

TR-800, TR-Series

Product Type

Respirator

Recommended Applicat

3M™ DBI-SALA® EZ-Stop™ III Web Shock-Absorbing Lanyard 1244024, 6 ft

3M Product Number 1244024 3M ID 7012817118 UPC 00648250160985

Details

Abrasion resistant tubular polyester webbing
Compact and integral energy absorber
Energy absorbing design limits fall arrest forces

Typical properties

Anchor Connection Type
Rebar Hook
Anchor Hook Material
Aluminum
Brands
DBI-SALA®
Case Quantity
1
Connected Safety ID Equipped
Yes
Energy Absorber Class
6 ft (1.8 m) Free Fall/MAAF 900 lbs. (4 kN)
Harness Connection Hook Material
Zinc Plated S

Dimensions and Classifications

Overall Length (Imperial)
6 ft

3M™ Hard Hat Terry Cloth Sweatband TCS1, White, For Use Over Standard Browpad, 10 ea/Case

Part Number TCS1 3M Product Number TCS1 3M ID 7100213827

Details

Works with all 3M hard hat suspensions giving workers more options
Absorbent and soft
Washable

Typical properties

Brands
3M™
Compatible Hard Hat
H-700, H-700T, H-800
For Use With
Hard Hats
High Heat
Yes
Material
Cotton/Synthetics
Product Color
White
Product Type
Sweatband
Recommended Application
Casting, Furnace, Sampling, Tapping
eClass 14 Classifica

3M™ PELTOR™ Hard Hat Attached Electrically Insulated Earmuffs X2P5E, 10 EA/Case

3M Product Number X2P5E 3M ID 7100097448 UPC 10078371671010

Details

Electrically insulated: Appropriate for a wide range of applications*
High-performance arms: Balance durability and flexibility
Easy click in/ click out: Move cups on and off ears easily
Convenient storage: Store with cups clicked in or out
Compatibility with hard hats: Designed for use with a standard hard hat slot**
Fit can be confirmed: Verify with 3M™ E-A-Rfit™ Dual-Ear Validation System***
Series has a wide range of attenuation: Choose from 21 dB NRR to 31 dB NRR
*These earmuff cups are made of non-conductive (sometimes referred to as “dielectric”) material while the metal components of the headbands and the helmet attachment mechanisms are covered in non-conductive material. This product was found to be electrically insulated, withstanding a voltage up to 1.2 kV, at an external laboratory against a modified test method based on EN 397:2012 under dry conditions. The user must determine the overall suitability of this product for the intended application taking into account any hazards other than noise for which this product is tested and approved. **This product was designed and tested with a 3M Hard Hat H700. For information on other hard hat models contact 3M. ***3M strongly recommends fit testing of hearing protectors. Research suggests that many users will receive less noise reduction than indicated by the NRR due to variation in earmuff fit, earmuff fitting skill and motivation of the user. If NRR is used, 3M recommends that it be reduced by 50% or in accordance with applicable regulations

Typical properties

Attenuation Rating
24.0 Decibel
Bluetooth
No
Brands
PELTOR™
Case Quantity
10
Corded
No
Dielectric
Yes
Earmuff Style
Hard Hat Attached
Electrically Insulated
Yes
Hearing Protection Style
Hard Hat Attached
Hearing Protection Type
Hard Hat

3M™ PELTOR™ X2 Earmuffs X2P3E/37276(AAD), Hard Hat Attached, 10 EA/Case

3M Product Number X2P3E 3M ID 7000104076 UPC 10093045937292

Details

Hard hat attached hearing protection with Noise Reduction Rating (NRR) of 24 dB for moderately high noise exposures
Fits a wide range of industrial safety hard hats, including 3M™ H-700 Series Hard Hats (sold separately)
Attaches directly to many hard hats without an adapter
Earcups tilt to ensure a customized fit and comfort for individual users
Adjustable earcups may be placed in three positions: 1) Usage position 2) Stand-by position, or 3) Storage position

Typical properties

Attenuation Rating
24.0 Decibel
Brands
PELTOR™
Case Quantity
10
Corded
No
Dielectric
No
Earmuff Style
Hard Hat Attached
Electrically Insulated
No
Hearing Protection Style
Hard Hat Attached
Metal Detectable
No
Moisture Resistant
No
Prod

3M™ PELTOR™ X2 Earmuffs X2A/37271(AAD), Over-the-Head, 10 EA/Case

3M Product Number X2A 3M ID 7000104071 UPC 10093045937247

Details

Over-the-head hearing protection with Noise Reduction Rating (NRR) of 24 dB for moderately high noise exposures

Twin headband design helps reduce heat buildup with good fit and balance

Wire headband offers comfortable pressure during prolonged usage

Earcups tilt to ensure a customized fit and comfort for individual users

Electrically insulated (dielectric) wire headband helps reduce exposure to electrical hazards

Typical properties

Attenuation Rating

24.0 Decibel

Bluetooth

No

Brands

PELTOR™

Case Quantity

10

Corded

No

Dielectric

Yes

Earmuff Style

Over the Head

Electrically Insulated

Yes

Hearing Protection Style

Over-the-Head

Hygiene Kit

HYX2

Metal Detectable

No

3M™ E-A-Rfit™ Dual-Ear Validation System 393-1100

3M Product Number 393-1100 3M ID 7100062125 UPC 00051141567648

Details

Dual-element, dual-microphone assembly is the key to the system, measuring sound levels inside and outside the hearing protector
Science-based, quantitative testing gives accurate reports of hearing protection
Fast, clear, accurate results are obtained in just seconds and can be printed or saved electronically for future reference
System determines personal attenuation rating (PAR) of individual workers and helps remove measurement, fitting, and spectral uncertainty
Dual-ear design saves time by measuring both ears simultaneously in under five seconds
System tests across 7 standard frequencies (125, 250, 500, 1000, 2000, 4000, 8000 Hz)
Works with a large variety of 3M Hearing Protection Products; earplugs, banded hearing protectors, and earmuffs
Simple, easy-to-use intuitive software
Worker and company reports created
Includes Software, Speaker And Impact Resistant Carrying Case
Free online training and user support
Requires probed test plugs, pods, or cushions

Typical properties

Brands
E-A-Rfit™
Case Quantity
1
Product Series
E-A-Rfit
Product Type
Fit Test Kit
Recommended Application
Health & Safety Testing
Recommended Industry
Automotive, Food Processing, Food Safety, General Manufacturing, Metal Fabrication, Military

3M™ Protecta® PRO™ Eyebolt Anchor, Threaded AN112A

Part Number AN112A 3M Product Number AN112A 3M ID 7100208214

Details

Easy to bolt or weld to various structures for a compact fall arrest anchor point
Corrosion-resistant, steel construction for durability
Recommended for construction, general industrial, mining, and oil and gas industries
Compatible with various fall arrest systems
Low-profile design stays out of the way as you work
This safety equipment is designed for use with additional personal fall protection systems
Meets the requirements of 29 CFR OSHA 1910.140, and OSHA 1926.502
Corrosion resistant stainless steel

Typical properties

Anchor Install Type
Permanent
Attachment Type
Bolt/Weld
Brands
PROTECTA®
Case Quantity
1
Connected Safety ID Equipped
No
Install Type
Permanent
Material
Zinc Plated Steel
Product Color
Silver
Product Series
PRO™
Product Type
Eyebolt Anc

3M™ Ultimate FX Full Facepiece Reusable Respirator FF-402 Medium 4 EA/Case

Part Number 89421 3M Product Number FF-402 3M ID 7000002284

Details

Recommended applications include assembly, chemical cleanup/handling, furnace operations, grinding, laboratories, machining, masonry, painting, sanding, sawing, and more

Meets the requirements of ANSI Z87.1-2003 standard for eye and face protection
Large lens for excellent field of vision, and treated with Scotchgard™ Protector to help cause some liquids to bead up for easier removal

Silicone face seal helps provide comfort and durability, and is easy to clean

Six-strap harness helps provide a secure comfortable fit

Use with 3M™ Particle Filters 2000, 2200, 7000, or 5000 Series to help filter certain particulates

Use with 3M 6000 Series Gas/Vapor Cartridges to help filter a broad range of gases and vapors

Use with 3M 6000 Series Combination Cartridges to help filter particulates in addition to gases and vapors

Compatible with 3M™ TR-600 and TR-800 powered air and Dual Airline supplied air systems against a variety of gases, vapors, and particulate hazards

Head cradle helps reduce pressure points and hair pulling

For workplace/occupational use only

Typical properties

Accessories

Yes

Assigned Protection Factor

10 Qualitative Fit Test, 50 Quantitative Fit Test

Brands

3M™

Cartridge or Filter Included

No

Case Quantity

4/case

Clip-on Welding Shield

No

Compatible with 3M™ PAPR Systems

Yes

Compatible with 3M™ S

3M™ Ultimate FX Full Facepiece Reusable Respirator FF-403, Large, 4 EA/Case

Part Number 89424 3M Product Number FF-403 3M ID 7100001847

Details

Recommended applications include assembly, chemical cleanup/handling, furnace operations, grinding, laboratories, machining, masonry, painting, sanding, sawing, and more

Meets the requirements of ANSI Z87.1-2003 standard for eye and face protection
Large lens for excellent field of vision, and treated with Scotchgard™ Protector to help cause some liquids to bead up for easier removal

Silicone face seal helps provide comfort and durability, and is easy to clean

Six-strap harness helps provide a secure comfortable fit

Use with 3M™ Particle Filters 2000, 2200, 7000, or 5000 Series to help filter certain particulates

Use with 3M 6000 Series Gas/Vapor Cartridges to help filter a broad range of gases and vapors

Use with 3M 6000 Series Combination Cartridges to help filter particulates in addition to gases and vapors

Compatible with 3M™ TR-600 and TR-800 powered air and Dual Airline supplied air systems against a variety of gases, vapors, and particulate hazards

Head cradle helps reduce pressure points and hair pulling

For workplace/occupational use only

Typical properties

Accessories

Yes

Assigned Protection Factor

10 Qualitative Fit Test, 50 Quantitative Fit Test

Brands

3M™

Cartridge or Filter Included

No

Case Quantity

4/case

Clip-on Welding Shield

No

Compatible with 3M™ PAPR Systems

Yes

Compatible with 3M™ S

3M™ Ultimate FX Full Facepiece Reusable Respirator FF-401, Small 4 EA/Case

3M Product Number FF-401 3M ID 7000029940 UPC 50051135894182

Details

Recommended applications include assembly, chemical cleanup/handling, furnace operations, grinding, laboratories, machining, masonry, painting, sanding, sawing, and more

Meets the requirements of ANSI Z87.1-2003 standard for eye and face protection
Large lens for excellent field of vision, and treated with Scotchgard™ Protector to help cause some liquids to bead up for easier removal

Silicone face seal helps provide comfort and durability, and is easy to clean

Six-strap harness helps provide a secure comfortable fit

Use with 3M™ Particle Filters 2000, 2200, 7000, or 5000 Series to help filter certain particulates

Use with 3M 6000 Series Gas/Vapor Cartridges to help filter a broad range of gases and vapors

Use with 3M 6000 Series Combination Cartridges to help filter particulates in addition to gases and vapors

Compatible with 3M™ TR-600 and TR-800 powered air and Dual Airline supplied air systems against a variety of gases, vapors, and particulate hazards

Head cradle helps reduce pressure points and hair pulling

For workplace/occupational use only

Typical properties

Accessories

Yes

Assigned Protection Factor

10 Qualitative Fit Test, 50 Quantitative Fit Test

Brands

3M™

Cartridge or Filter Included

No

Case Quantity

4/case

Clip-on Welding Shield

No

Compatible with 3M™ PAPR Systems

Yes

Compatible with 3M™ S

3M™ Filter Adapter 502, 100 EA/Case

3M Product Number 502 3M ID 7000001931 UPC 50051138215113

Details

Approved 3M system component
Designed to attach 3M™ Particulate Filters 2000/2200 Series and 7093/7093C to 3M gas/vapor respirators and cartridges
Component works with 3M Respirator 5000 Series and 3M Cartridges 6000 Series (sold separately)
Particle filter adapters increases scope of potential applications
Color: translucent white
Refer to Filter/Cartridge User Instructions for more information

Typical properties

Accessories
Yes
Brands
3M™
Case Quantity
20/pack
Clip-on Welding Shield
Yes
Compatible Respirator
6500QL Series
Compatible with 3M™ PAPR Systems
Yes
Compatible with 3M™ Supplied Air System
Yes
Compatible with Welding Shield
Yes
Connection

3M™ Filter Adapter 603, 100 ea/Case

3M Product Number 603 3M ID 7100162621

Details

Reusable: can be wiped down between uses

3M™ 603 Filter Adapters has a bayonet attachment

Easy installation

For attaching 5N11 and 5P71 filters and 501 retainers to 3M™ 6000, 7000 and FF-400 series reusable respirator facepieces or 3M™ Scott™ AV-3000 HT and AV-3000 SureSeal facepiece with 3M™ Scott™ AV-632 Bayonet Adapter

Typical properties

Accessories

No

Brands

3M™

Case Quantity

100/case

Clip-on Welding Shield

No

Compatible with 3M™ PAPR Systems

No

Compatible with 3M™ Supplied Air System

No

Compatible with Welding Shield

No

Cool Flow™ Exhalation Valve

No

Drop-down Feature

N

3M™ DBI-SALA® Nano-Lok™ Twin-Leg Fixed D-ring Connector 3100087, Zinc Plated Steel

Part Number 3100107 3M Product Number 3100107 3M ID 7012818428

Details

Enables connecting a second self-retracting lifeline to the safety harness
Available in steel and aluminum models
High strength construction

Typical properties

Brands
DBI-SALA®
Connected Safety ID Equipped
No
Dimensions
4.30x2.30x0.80in
Housing Type
None
Mounting Type
Direct to Harness Back
Product Series
Nano-Lok™
Product Type
Twin-Leg Fixed D-ring Connector
Recommended Industry
Construction, Gen

3M™ Lens Assembly 6898/37006(AAD), Replacement Part 5 EA/Case

Part Number 37006 3M Product Number 6898 3M ID 7000002036

Details

Approved 3M replacement part
Recommended for 3M Full Facepiece 6000 Series (sold separately)
Replacement part can extend service life of facepiece
Replaceable lens assembly can potentially result in respiratory equipment cost savings
Assembly maintains original service performance of facepiece

Typical properties

Accessories
No
Boxes per Case
5
Brands
3M™
Case Quantity
5/case
Clip-on Welding Shield
No
Compatible Respirator
6000 Series
Compatible with 3M™ PAPR Systems
No
Compatible with 3M™ Supplied Air System
No
Compatible with Welding Shield
No

3M™ Lens Replacement FF-400-03, Replacement Part 5 EA/Case

Part Number 89475 3M Product Number FF-400-03 3M ID 7100009686

Details

Replacement part to use with 3M Ultimate FX Full Facepiece Reusable Respirators FF-401, FF-402, and FF-403 (sold separately)
Designed for use with the 3M Ultimate FX Full Facepiece Reusable Respirators (sold separately)
Maintains original performance standards of facepiece
Weighs only 8.2 ounces
Replaceable part can potentially result in respiratory equipment cost savings

Typical properties

Accessories
Yes
Boxes per Case
5
Brands
3M™
Case Quantity
5/case
Clip-on Welding Shield
No
Compatible Respirator
FF-400 Series
Compatible with 3M™ PAPR Systems
No
Compatible with 3M™ Supplied Air System
Yes
Compatible with Welding Shield

3M™ 332 Impact Safety Goggles Anti-Fog 40651-00000-10, Clear Anti Fog Lens, 10 EA/Case

3M Product Number 40651-00000-10 3M ID 7000030007 UPC 10078371621381

Details

Economical goggle
Direct venting system that circulates air and helps minimize fogging
Over-the-glass coverage
Clear lens

Typical properties

ANSI Requirements
ANSI Z87.1-2003
Anti Fog Lens
Yes
Brands
3M™
Case Quantity
10
Class
Economy
Comfort Features
Adjustable elastic strap, Direct Ventilation, Fits over most glasses
Eyewear Range
Economy
Frame Color
Clear
Frame Style
Goggle

3M™ Protecta® Pro™ Concrete Anchor Strap 2190063, 25 ea/Pack

Part Number 2190063 3M Product Number 2190063 3M ID 7100232043

Details

- 42 in. (1m) concrete anchor strap
- Loop slips over rebar for fast installation
- Durable polyester construction
- Abrasion resistant polyester wear pad
- Web loop for carabiner and fall arrest system
- Compact and lightweight design
- Economical disposable design
- 25-pack for added value

Typical properties

- Anchor Install Type
Permanent
- Attachment Type
Pass-through/Choker
- Brands
PROTECTA®
- Case Quantity
1
- Connected Safety ID Equipped
No
- Install Type
Disposable
- Material
Polyester Web
- Product Color
Blue
- Product Series
PRO™
- Product Type
Concre

Dimensions and Classifications

- Overall Length (Imperial)
42 in

3M™ Protecta® Pass-Thru Web Concrete Strap Anchor with D-ring 2190064, Polyester, 6 ft

Part Number 2190064 3M Product Number 2190064 3M ID 7012818374

Details

- 72 in. (1.8m) concrete anchor strap
- Loop slips over rebar for fast installation
- Durable polyester construction
- Abrasion resistant polyester wear pad
- High strength steel D-ring
- Compact and lightweight design
- Economical disposable design
- 25-pack for added value

Typical properties

- Anchor Install Type
Permanent
- Attachment Type
Pass-through/Choker
- Brands
PROTECTA®
- Case Quantity
25
- Connected Safety ID Equipped
No
- Install Type
Disposable
- Material
Polyester Web
- Product Color
Red
- Product Series
PRO™
- Product Type
Concre

Dimensions and Classifications

- Overall Length (Imperial)
72 in

3M™ Protecta® Pro™ Concrete Anchor Strap 2190057, 25 ea/Pack

Part Number 2190057 3M Product Number 2190057 3M ID 7100232042

Details

- 42 in. (1m) concrete anchor strap
- Loop slips over rebar for fast installation
- Durable polyester construction
- Abrasion resistant polyester wear pad
- High strength steel D-ring
- Compact and lightweight design
- Economical disposable design
- 25-pack for added value

Typical properties

- Anchor Install Type
Permanent
- Attachment Type
Pass-through/Choker
- Brands
PROTECTA®
- Case Quantity
25
- Connected Safety ID Equipped
No
- Install Type
Disposable
- Material
Polyester Web
- Product Color
Red
- Product Series
PRO™
- Product Type
Concre

Dimensions and Classifications

- Overall Length (Imperial)
42 in

3M™ PROTECTA® PRO™ Knock-Down Disposable Roof Anchor 2103680, 12/Pack

Part Number 2103680 3M Product Number 2103680 3M ID 7100221375

Details

Durable materials and hardware designed to help stand up to harsh working conditions
Compatible with various fall arrest systems, not compliant for use with Horizontal Lifelines
Suitable for use in general industrial and construction industries
Compact, lightweight design
Meets the requirements for 29 CFR OSHA 1910.140 and 29 CFR OSHA 1926.502
Features corrosion-resistant, steel and aluminum construction for durability
This safety equipment is designed for use with additional personal protective equipment (PPE)
Optimal installation is located at the roof peak
Includes fastener kit for fast and easy nail installation
Fall arrest- and restraint-rated for one worker
Includes 12 units in each pack

Typical properties

Anchor Install Type
Permanent
Attachment Type
Nail
Brands
PROTECTA®
Case Quantity
12
Connected Safety ID Equipped
No
Dimensions
(23.20x2.00x0.07)in
Install Type
Disposable
Material
Zinc Plated Steel
Product Color
Yellow Zinc
Product Seri

3M™ DBI-SALA® Roof Top Anchor - For Metal, Concrete, Wood Roofs 2100133, Silver

Part Number 2100133 3M Product Number 2100133 3M ID 7100228409

Details

Durable materials and hardware designed to help stand up to harsh working conditions

Compatible with various fall arrest systems

Suitable for use in general industrial and construction industries

Compact, lightweight design

Meets the requirements for 29 CFR OSHA 1910.140 and 29 CFR OSHA 1926.502

Features corrosion-resistant, steel and aluminum construction for durability

This safety equipment is designed for use with additional personal protective equipment (PPE)

Installs to 24 gauge or thicker metal, 5/8 in. (1.6 cm) wood and 3,000 PSI (21 MPa) concrete roofs. For use on flat or sloped (up to 3:12 pitch) roof decks

Accommodates roof ribs 10-20 in. (25.4-50.1cm) apart in 1 in. (2.5cm) increments

Swiveling tie-off point for complete mobility. Load distributing design protects roof and user

Multi-person use with horizontal lifeline system with multiple fastener options available

Typical properties

Anchor Install Type

Permanent

Attachment Type

Rivet/Fablok/Teks Screw

Brands

DBI-SALA®

Case Quantity

1

Connected Safety ID Equipped

No

Dimensions

(21.70x17.70x10.00)in

For Use With

Concrete, Metal, Wood Roofs

Install Type

Permanent

Material

3M™ DBI-SALA® Reusable Hinged Roof Anchor For Wood/Metal 2103676, with Fastener Kit

Part Number 2103676 3M Product Number 2103676 3M ID 7100309981

Details

Durable materials and hardware designed to help stand up to harsh working conditions
Compatible with various fall arrest systems, not compliant for use with Horizontal Lifelines
Suitable for use in general industrial and construction industries
Compact, lightweight design
Meets the requirements for 29 CFR OSHA 1910.140 and 29 CFR OSHA 1926.502
Features corrosion-resistant, steel and aluminum construction for durability
This safety equipment is designed for use with additional personal protective equipment (PPE)
Installs to sloped or flat wood and metal decking roofs
Fast and easy nail or screw installation - Fastener kit included
Hinged design with D-ring
Portable and reusable

Typical properties

Anchor Install Type
Reusable
Anchor Type
Roofing
Attachment Type
Nail/Screw
Brands
DBI-SALA®
Case Quantity
1
Connected Safety ID Equipped
No
Dimensions
17.00x0.60x4.00in
Install Type
Reusable
Material
Steel
Product Color
Yellow Zinc
Pr

3M™ DBI-SALA® SecuraSpan™ Rebar/Shear Stud HLL Stanchion with Base

7400215, 1 ea

Part Number 7400215 3M Product Number 7400215 3M ID 7100220295

Details

Zinc-plated steel materials are and stand up to harsh environments
Single-span systems hold up to 2 workers; multi-span systems hold up to 6 workers
Top-mounted bolt and clamp adjustment system for easy installation, safety, and convenience
Portable design is durable, yet lightweight, for easy transport
Equipped with RFID identification tag for convenient equipment tracking
This safety equipment is intended for use with additional personal protective equipment (PPE)
Recommended for use in multiple industries including construction, facilities, power plants, general manufacturing, heavy infrastructure, and more

Typical properties

Brands
DBI-SALA®
Case Quantity
1
Connected Safety ID Equipped
Yes
For Use With
3M™ DBI-SALA® SecuraSpan™ Rebar/Shear Stud HLL System
Install Type
Temporary/Portable
Lifeline Material
Order separately
Maximum Number of Workers
2 Per Span, 6 To

3M™ Protecta® Rope Lifeline with Swivel Snap Hook 1299991, 5/8 in Polyester and Polypropylene Blend, White, 30 ft

Part Number 1299991 3M Product Number 1299991 3M ID 7012817329

Details

Provides freedom of movement operation
Detachable
Brake locks rope grab onto lifeline in case of a fall

Typical properties

Attachment Type
None
Brands
PROTECTA®
Case Quantity
1
Connected Safety ID Equipped
No
Connector Material
Swiveling Snap Hook
Install Type
Temporary
Lifeline Length (Imperial)
30 ft
Lifeline Length (Metric)
9.14 m
Lifeline Material
Polyest

Dimensions and Classifications

Overall Length (Imperial)
30 ft

3M™ Protecta® Rope Lifeline with Swivel Snap Hook 1299992, 5/8 in Polyester and Polypropylene Blend, White, 75 ft

Part Number 1299992 3M Product Number 1299992 3M ID 7012529203

Details

Provides freedom of movement operation
Detachable
Brake locks rope grab onto lifeline in case of a fall

Typical properties

Attachment Type
None
Brands
PROTECTA®
Case Quantity
1
Connected Safety ID Equipped
No
Connector Material
Swiveling Snap Hook
Install Type
Temporary
Lifeline Length (Imperial)
75 ft
Lifeline Length (Metric)
22.86 m
Lifeline Material
Polyes

Dimensions and Classifications

Overall Length (Imperial)
75 ft

3M™ DBI-SALA® Confined Space Heavy-Duty Sleeve Cap For Davit Mast Base 8510827, Stainless Steel

3M Product Number 8510827 3M ID 7100278722 UPC 00648250238653

Details

Designed to reduce water intrusion into the davit base
Available in zinc-plated steel and stainless steel
Recommended for use in multiple industries

Typical properties

Brands
DBI-SALA®
Material
Stainless Steel
Product Type
Heavy Duty Sleeve Cap for Permanent Davit Bases
eClass 14 Classification Group
13090401

3M™ DBI-SALA® Confined Space Heavy-Duty Sleeve Cap For Davit Mast Base 8510826, Zinc Plated Steel

Part Number 8510826 3M Product Number 8510826 3M ID 7100280642

Details

Designed to reduce water intrusion into the davit base
Available in zinc-plated steel and stainless steel
Recommended for use in multiple industries

Typical properties

Brands
DBI-SALA®
Case Quantity
1
Connected Safety ID Equipped
No
Dimensions
3.50x3.50x1.40lbs
For Use With
Permanent Davit Bases
Install Type
Portable
Net Weight (Imperial)
1.1 lb
Product Color
Yellow Zinc
Product Type
Heavy Duty Sleeve C

3M™ DBI-SALA® Web D-ring Extension Anchor 1231123, Polyester, 2 ft

Part Number 1231123 3M Product Number 1231123 3M ID 7012817028

Details

- Extends dorsal harness D-ring (or overhead anchor point)
- High strength D-ring tie-off point
- Constructed with abrasion resistant materials
- Built-in wear indicator

Typical properties

- Anchor Hook Material
 - Zinc Plated Steel
- Brands
 - DBI-SALA®
- Case Quantity
 - 1
- Connected Safety ID Equipped
 - Yes
- Harness Connection Hook Material
 - Zinc Plated Steel
- Lanyard Material
 - Polyester Web
- Material
 - Polyester Web
- Product Color
 - Yellow
- Product

Dimensions and Classifications

- Overall Length (Imperial)
 - 2 ft

3M™ DBI-SALA® Web D-ring Extension Anchor 1231135, Polyester, 3 ft

Part Number 1231135 3M Product Number 1231135 3M ID 7012817030

Details

Extends dorsal harness D-ring (or overhead anchor point)
High strength D-ring tie-off point
Constructed with abrasion resistant materials
Built-in wear indicator

Typical properties

Anchor Hook Material
Zinc Plated Steel
Brands
DBI-SALA®
Case Quantity
1
Connected Safety ID Equipped
Yes
Harness Connection Hook Material
Zinc Plated Steel
Lanyard Material
Polyester Web
Material
Polyester Web
Product Color
Yellow
Product

Dimensions and Classifications

Overall Length (Imperial)
3 ft

3M™ DBI-SALA® Web D-ring Extension Anchor 1231156, Polyester, 6 ft

Part Number 1231156 3M Product Number 1231156 3M ID 7012817033

Details

Extends dorsal harness D-ring (or overhead anchor point)
High strength D-ring tie-off point
Constructed with abrasion resistant materials
Built-in wear indicator

Typical properties

Anchor Hook Material
Zinc Plated Steel
Brands
DBI-SALA®
Case Quantity
1
Connected Safety ID Equipped
Yes
Harness Connection Hook Material
Zinc Plated Steel
Lanyard Material
Polyester Web
Material
Polyester Web
Product Color
Yellow
Product

Dimensions and Classifications

Overall Length (Imperial)
6 ft

3M™ DBI-SALA® Web D-ring Extensioin Anchor 1231141, Polyester, 4 ft

Part Number 1231141 3M Product Number 1231141 3M ID 7012817032

Details

Extends dorsal harness D-ring (or overhead anchor point)
High strength D-ring tie-off point
Constructed with abrasion resistant materials
Built-in wear indicator

Typical properties

Anchor Hook Material
Zinc Plated Steel
Brands
DBI-SALA®
Case Quantity
1
Connected Safety ID Equipped
Yes
Harness Connection Hook Material
Zinc Plated Steel
Lanyard Material
Polyester Web
Material
Polyester Web
Product Color
Yellow
Product

Dimensions and Classifications

Overall Length (Imperial)
4 ft

3M™ Probed Reusable Respirator Assembly 6200Q Medium 4 EA/Case

3M Product Number 6200Q 3M ID 7000126030 UPC 50051138289206

Details

Respirator assembly for quantitative fit testing on 3M Respirators 6000 Series
Assembly includes probed facepiece and P100 filters
Fit test assesses the fit of respirator to wearer's face
Probe inside the facemask allows measurement of leakage into the respirator
Quantitative fit testing provides numerical results for documentation purposes

Typical properties

Accessories

No

Brands

3M™

Case Quantity

4

Clip-on Welding Shield

No

Compatible with 3M™ PAPR Systems

No

Compatible with 3M™ Supplied Air System

Yes

Compatible with Welding Shield

Yes

Cool Flow™ Exhalation Valve

No

Drop-down Feature

Yes

E

3M™ BX™ Protective Eyewear 11380-00000-20, Clear Anti-Fog Lens, Silver/Black Frame, 20 ea/Case

3M Product Number 11380-00000-20 3M ID 7000052795 UPC 10078371620520

Details

Sleek, contoured design combines style and function
Soft nose bridge offers pleasant extended wear
Adjustable length temples and lens angle allow for customized fit
Polycarbonate lenses absorb 99.9% UVA and UVB up to 380 nm
Polycarbonate lenses absorb 99.9% UVA and UVB up to 380 nm

Typical properties

ANSI Requirements

ANSI Z87.1-2003

Anti Fog Lens

Yes

Brands

BX™

Case Quantity

20

Class

Value

Comfort Features

Adjustable length temples, Lens angle adjustment, Soft nose bridge

Diopter

0

Eyewear Range

Value

Frame Color

Silver/Black

Frame

Dimensions and Classifications

Overall Height (Imperial)

2 in

Overall Height (Metric)

5.08 cm

Overall Length (Imperial)

2 in

Overall Length (Metric)

5.08 cm

Overall Width (Imperial)

2.2 in

Overall Width (Metric)

5.588 cm

3M™ BX™ Protective Eyewear 11381-00000-20, Grey Anti-Fog Lens, Silver/Black Frame, 20 ea/Case

3M Product Number 11381-00000-20 3M ID 7000052796 UPC 10078371620537

Details

Sleek, contoured design combines style and function
Soft nose bridge offers pleasant extended wear
Adjustable length temples and lens angle allow for customized fit
Polycarbonate lenses absorb 99.9% UVA and UVB up to 380 nm
Polycarbonate lenses absorb 99.9% UVA and UVB up to 380 nm

Typical properties

ANSI Requirements
ANSI Z87.1-2003 and CSA Z94.3-2007
Anti Fog Lens
Yes
Brands
BX™
Case Quantity
20
Class
Value
Comfort Features
Adjustable length temples, Lens angle adjustment, Soft nose bridge
Diopter
0
Eyewear Range
Value
Frame Color
S

Dimensions and Classifications

Overall Height (Imperial)
2 in
Overall Height (Metric)
5.08 cm
Overall Length (Imperial)
2 in
Overall Length (Metric)
5.08 cm
Overall Width (Imperial)
2.2 in
Overall Width (Metric)
5.588 cm

3M™ DBI-SALA® Confined Space Carrying Bag for 7 ft Aluminum Tripod KK0RM3094

Part Number 9503094 3M Product Number 9503094 3M ID 7100240883

Details

- Portable davit base includes three pieces
- Adjustable width base
- Adjustable foot-leveling system
- Built-in level indicator
- Corrosion-resistant aluminum construction
- Easy to set-up and dismantle without tools

Typical properties

- Brands
DBI-SALA®
- Case Quantity
1
- CoWorker Controlled Ascent
No
- CoWorker Controlled Descent
No
- Connected Safety ID Equipped
No
- Descent Type
None
- For Use With
Aluminum Tripods
- Net Weight (Imperial)
1.5 lb
- Net Weight (Metric)
0.7 kg
- Product

Dimensions and Classifications

- Overall Length (Imperial)
7 ft
- Overall Length (Metric)
2.1 m
- Overall Width (Imperial)
10 in
- Overall Width (Metric)
25.4 cm

3M™ DBI-SALA® Confined Space Carrying Bag Set For 5-Piece Davit Hoist 8518513

Part Number 8518513 3M Product Number 8518513 3M ID 7100280646

Details

- Portable davit base includes three pieces
- Adjustable width base
- Adjustable foot-leveling system
- Built-in level indicator
- Corrosion-resistant aluminum construction
- Easy to set-up and dismantle without tools

Typical properties

- Brands
DBI-SALA®
- Case Quantity
1
- Connected Safety ID Equipped
No
- For Use With
5-piece Davit Hoist
- Net Weight (Imperial)
7.3 lb
- Net Weight (Metric)
3.3 kg
- Product Color
Black
- Product Series
Advanced™
- Product Type
Equipment Carrying & Stora

3M™ DBI-SALA® Confined Space Carrying Bag for 9 ft. Aluminum Tripod 9503095

Part Number 9503095 3M Product Number 9503095 3M ID 7100240884

Details

- Portable davit base includes three pieces
- Adjustable width base
- Adjustable foot-leveling system
- Built-in level indicator
- Corrosion-resistant aluminum construction
- Easy to set-up and dismantle without tools

Typical properties

- Brands
DBI-SALA®
- Case Quantity
1
- Connected Safety ID Equipped
No
- For Use With
Aluminum Tripods
- Net Weight (Imperial)
1.8 lb
- Net Weight (Metric)
0.8 kg
- Product Color
Blue
- Product Series
Advanced™
- Product Type
Equipment Carrying & Storage B

Dimensions and Classifications

- Overall Length (Imperial)
104 in
- Overall Length (Metric)
264.2 cm
- Overall Width (Imperial)
10 in
- Overall Width (Metric)
25.4 cm

3M™ DBI-SALA® Confined Space Carrying Bag For Davit Mast/Extension 8513564

Part Number 8513564 3M Product Number 8513564 3M ID 7010616062

Details

- Portable davit base includes three pieces
- Adjustable width base
- Adjustable foot-leveling system
- Built-in level indicator
- Corrosion-resistant aluminum construction
- Easy to set-up and dismantle without tools

Typical properties

- Brands
DBI-SALA®
- Case Quantity
1
- Connected Safety ID Equipped
No
- For Use With
Offset Davit Mast and Extensions
- Net Weight (Imperial)
3.4 lb
- Net Weight (Metric)
1.5 kg
- Product Color
Black
- Product Series
Advanced™
- Product Type
Equipment Car

Dimensions and Classifications

- Overall Length (Imperial)
52 in
- Overall Length (Metric)
132.1 cm
- Overall Width (Imperial)
14 in
- Overall Width (Metric)
35.6 cm

3M™ DBI-SALA® Advanced™ Carrying Bag 8517565, 1 EA

Part Number 8517565 3M Product Number 8517565 3M ID 7100214172

Details

Carrying bags for Confined Space equipment
Polyester construction
Built-in web carrying handles
Zipper closure
Recommended for use in multiple industries

Typical properties

Brands
DBI-SALA®
Case Quantity
1
Connected Safety ID Equipped
No
For Use With
Portable Fall Arrest Post
Install Type
None
Net Weight (Imperial)
3 lb
Net Weight (Metric)
1.4 kg
Product Series
Advanced™
Product Type
Carrying Bag
Recommendations

3M™ DBI-SALA® Confined Space Carrying Bag for 3-Piece Davit Base 8513565

Part Number 8513565 3M Product Number 8513565 3M ID 7100274753

Details

Carrying bags for Confined Space equipment
Polyester construction
Built-in web carrying handles
Zipper closure
Recommended for use in multiple industries

Typical properties

Brands
DBI-SALA®
Net Weight (Imperial)
5.1 lb
Net Weight (Metric)
2.3 kg
Product Series
Advanced™
Recommended Industry
Construction, General Industrial, Mining, Oil & Gas, Transportation, Utilities
eClass 14 Classification Group
13090401

3M™ DBI-SALA® Flexiguard™ Box-Frame Rail Adjustable Height Anchor System 8530288, 2 User, 12 - 18 ft High, 12 ft Wide

Part Number 8530288 3M Product Number 8530288 3M ID 7012820910

Details

Secure fall protection with intuitive pin-height selection system. The system can be adjusted using an overhead crane, forklift or other powered system
Provides an overhead sliding anchor point for one, two or more personnel, maximum one person per trolley
Fixed and Adjustable height systems
Solid rubber wheels available
Aluminum and steel construction
Requires clearance over equipment being accessed
Accessories available to suit worksite needs including optional tow bar
Conforms to OSHA 1926.502 and OSHA 1910.66 requirements
Overhead anchoring can improve at-height work safety; an effective fall arrest system
Recommended for numerous applications within the transportation, construction, utilities, and mining industries

Typical properties

Brands
DBI-SALA®
Case Quantity
1
Connected Safety ID Equipped
Yes
Install Type
Temporary/Portable
Maximum Height (Imperial)
19.27 ft
Maximum Height (Metric)
5.87 m
Maximum Number of Users
Two
Product Color
Silver, Yellow
Product Series
FI

Dimensions and Classifications

Overall Width (Imperial)
23.28 ft
Overall Width (Metric)
7.06 m

3M™ PELTOR™ Optime™ 95 Earmuffs H6A/V, Over-the-Head, 10 EA/Case

3M Product Number H6A/V 3M ID 7000009667 UPC 10093045080615

Details

Earmuff provide hearing protection against high-frequency noise up to 95 dBA
Ultra-light hearing protectors are less noticeable to wear
Folding design offers compact storage
Earmuffs provide relief with Noise Reduction Rating (NRR) of 21 decibels

Typical properties

Attenuation Rating
21.0 Decibel
Bluetooth
No
Brands
PELTOR™
Case Quantity
10
Corded
No
Dielectric
No
Earmuff Style
Over the Head
Electrically Insulated
No
Hearing Protection Style
Over-the-Head
Material
ABS
Metal Detectable
No
Moisture

3M™ PELTOR™ Optime™ 95 Earmuffs H6B/V, Behind-the-Head, 10 EA/Case

Part Number 08062 3M Product Number H6B/V 3M ID 7000009666

Details

For noise levels up to 95 dBA
Stainless steel construction resists bending and warping
Earcup pivot points tilt for optimum comfort and efficiency
Noise Reduction Rating (NRR)*: 21dB. CSA Class B

Typical properties

Attenuation Rating
21.0 Decibel
Bluetooth
No
Brands
PELTOR™
Case Quantity
10
Corded
No
Dielectric
No
Earmuff Style
Behind the Head
Electrically Insulated
No
Hearing Protection Style
Behind-the-Head
Hearing Protection Type
Headband
Mate

3M™ Versaflo™ Spark Arrestor TR-662, for TR-600/800 PAPR 2/BAG

Part Number 37355 3M Product Number TR-662 3M ID 7100035845

Details

Protects TR-6000 series filters and cartridges from potential damage due to sparks

May reduce operating costs by extending the life of TR-6000 series filters and cartridges

May lower operating costs when used as a cleanable pre-filter

Flexible application because TR-662 may be used with TR-6600 prefilter

Typical properties

Brands

Versaflo™

Case Quantity

2/pack

Compatible With

3M™ Versaflo™ TR-600 Series PAPR, 3M™ Versaflo™ TR-800 Series PAPR

Hazard Type

Silica

Intrinsically Safe

No

Mounting Type

Belt-mounted

Net Weight (Metric)

5 g

Product Series

TR-600, TR-8

3M™ Full Facepiece Reusable Respirator 6900 Large 4 EA/Case

Part Number 54159 3M Product Number 6900 3M ID 7000002037

Details

Recommended applications include assembly, chemical cleanup/handling, chemical splash, chiseling, cleaning, furnace operations, grinding, laboratories, machining, masonry, painting, sanding, sawing, and more

Meets the requirements of the ANSI Z87.1-2010 standard, high impact level for eye and face protection

Large lens for excellent field of vision

Silicone face seal helps provide comfort and durability, and is easy to clean

Four-point harness provides a secure, comfortable fit

Use with 3M™ Particle Filters 2000, 2200, 7000, or 5000 Series to filter certain particulates

Use with 3M 6000 Series Gas/Vapor Cartridges to help filter a broad range of gases and vapors

Use with 3M 6000 Series Combination Cartridges to help filter particulates in addition to gases and vapors

Compatible with 3M™ TR-600 and TR-800 powered air and Dual Airline supplied air systems against a variety of gases, vapors, and particulate hazards

For workplace/occupational use only

Typical properties

Accessories

Yes

Assigned Protection Factor

10 Qualitative Fit Test, 50 Quantitative Fit Test

Brands

3M™

Cartridge or Filter Included

No

Case Quantity

4/case

Clip-on Welding Shield

No

Compatible with 3M™ PAPR Systems

Yes

Compatible with 3M™ S

3M™ Full Facepiece Reusable Respirator 6700DIN Small 4 EA/Case

Part Number 6700DIN 3M Product Number 6700DIN 3M ID 7000126399

Details

Recommended applications include assembly, chemical cleanup/handling, chemical splash, chiseling, cleaning, furnace operations, grinding, laboratories, machining, masonry, painting, sanding, sawing, and more

Meets the requirements of the ANSI Z87.1-2010 standard, high impact level for eye and face protection

Large lens for excellent field of vision

Silicone face seal helps provide comfort and durability, and is easy to clean

Four-point harness provides a secure, comfortable fit

Use with 3M™ Particle Filters 2000, 2200, 7000, or 5000 Series to filter certain particulates

Use with 3M 6000 Series Gas/Vapor Cartridges to help filter a broad range of gases and vapors

Use with 3M 6000 Series Combination Cartridges to help filter particulates in addition to gases and vapors

Compatible with 3M™ TR-600 and TR-800 powered air and Dual Airline supplied air systems against a variety of gases, vapors, and particulate hazards

For workplace/occupational use only

Typical properties

Accessories

Yes

Assigned Protection Factor

10 Qualitative Fit Test, 50 Quantitative Fit Test

Brands

3M™

Cartridge or Filter Included

No

Case Quantity

4/case

Clip-on Welding Shield

No

Compatible with 3M™ PAPR Systems

Yes

Compatible with 3M™ S

3M™ Full Facepiece Reusable Respirator 6700 Small 4 EA/Case

3M Product Number 6700 3M ID 7000002029 UPC 50051138541458

Details

Recommended applications include assembly, chemical cleanup/handling, chemical splash, chiseling, cleaning, furnace operations, grinding, laboratories, machining, masonry, painting, sanding, sawing, and more

Meets the requirements of the ANSI Z87.1-2010 standard, high impact level for eye and face protection

Large lens for excellent field of vision

Silicone face seal helps provide comfort and durability, and is easy to clean

Four-point harness provides a secure, comfortable fit

Use with 3M™ Particle Filters 2000, 2200, 7000, or 5000 Series to filter certain particulates

Use with 3M 6000 Series Gas/Vapor Cartridges to help filter a broad range of gases and vapors

Use with 3M 6000 Series Combination Cartridges to help filter particulates in addition to gases and vapors

Compatible with 3M™ TR-600 and TR-800 powered air and Dual Airline supplied air systems against a variety of gases, vapors, and particulate hazards

For workplace/occupational use only

Typical properties

Accessories

Yes

Assigned Protection Factor

10 Qualitative Fit Test, 50 Quantitative Fit Test

Brands

3M™

Cartridge or Filter Included

No

Case Quantity

4/case

Clip-on Welding Shield

No

Compatible with 3M™ PAPR Systems

Yes

Compatible with 3M™ S

3M™ Full Facepiece Reusable Respirator 6800 Medium 4 EA/Case

Part Number 54146 3M Product Number 6800 3M ID 7000002030

Details

Recommended applications include assembly, chemical cleanup/handling, chemical splash, chiseling, cleaning, furnace operations, grinding, laboratories, machining, masonry, painting, sanding, sawing, and more

Meets the requirements of the ANSI Z87.1-2010 standard, high impact level for eye and face protection

Large lens for excellent field of vision

Silicone face seal helps provide comfort and durability, and is easy to clean

Four-point harness provides a secure, comfortable fit

Use with 3M™ Particle Filters 2000, 2200, 7000, or 5000 Series to filter certain particulates

Use with 3M 6000 Series Gas/Vapor Cartridges to help filter a broad range of gases and vapors

Use with 3M 6000 Series Combination Cartridges to help filter particulates in addition to gases and vapors

Compatible with 3M™ TR-600 and TR-800 powered air and Dual Airline supplied air systems against a variety of gases, vapors, and particulate hazards

For workplace/occupational use only

Typical properties

Accessories

Yes

Assigned Protection Factor

10 Qualitative Fit Test, 50 Quantitative Fit Test

Brands

3M™

Cartridge or Filter Included

No

Case Quantity

4/case

Clip-on Welding Shield

No

Compatible with 3M™ PAPR Systems

Yes

Compatible with 3M™ S

3M™ Full Facepiece Reusable Respirator 6800DIN, Medium 4 EA/Case

3M Product Number 6800DIN 3M ID 7000029682 UPC 50051138767025

Details

Recommended applications include assembly, chemical cleanup/handling, chemical splash, chiseling, cleaning, furnace operations, grinding, laboratories, machining, masonry, painting, sanding, sawing, and more

Meets the requirements of the ANSI Z87.1-2010 standard, high impact level for eye and face protection

Large lens for excellent field of vision

Silicone face seal helps provide comfort and durability, and is easy to clean

Four-point harness provides a secure, comfortable fit

Use with 3M™ Particle Filters 2000, 2200, 7000, or 5000 Series to filter certain particulates

Use with 3M 6000 Series Gas/Vapor Cartridges to help filter a broad range of gases and vapors

Use with 3M 6000 Series Combination Cartridges to help filter particulates in addition to gases and vapors

Compatible with 3M™ TR-600 and TR-800 powered air and Dual Airline supplied air systems against a variety of gases, vapors, and particulate hazards

For workplace/occupational use only

Typical properties

Accessories

Yes

Assigned Protection Factor

10 Qualitative Fit Test, 50 Quantitative Fit Test

Brands

3M™

Cartridge or Filter Included

No

Case Quantity

4/case

Clip-on Welding Shield

No

Compatible with 3M™ PAPR Systems

Yes

Compatible with 3M™ S

3M™ Full Facepiece Reusable Respirator 6900DIN Large 4 EA/Case

Part Number 76703 3M Product Number 6900DIN 3M ID 7000126400

Details

Recommended applications include assembly, chemical cleanup/handling, chemical splash, chiseling, cleaning, furnace operations, grinding, laboratories, machining, masonry, painting, sanding, sawing, and more

Meets the requirements of the ANSI Z87.1-2010 standard, high impact level for eye and face protection

Large lens for excellent field of vision

Silicone face seal helps provide comfort and durability, and is easy to clean

Four-point harness provides a secure, comfortable fit

Use with 3M™ Particle Filters 2000, 2200, 7000, or 5000 Series to filter certain particulates

Use with 3M 6000 Series Gas/Vapor Cartridges to help filter a broad range of gases and vapors

Use with 3M 6000 Series Combination Cartridges to help filter particulates in addition to gases and vapors

Compatible with 3M™ TR-600 and TR-800 powered air and Dual Airline supplied air systems against a variety of gases, vapors, and particulate hazards

For workplace/occupational use only

Typical properties

Accessories

Yes

Assigned Protection Factor

10 Qualitative Fit Test, 50 Quantitative Fit Test

Brands

3M™

Cartridge or Filter Included

No

Case Quantity

4/case

Clip-on Welding Shield

No

Compatible with 3M™ PAPR Systems

Yes

Compatible with 3M™ S

3M™ Speedglas™ Auto-Darkening Filter ADF 100V 07-0001-31/37246 (AAD), Variable Shade 8-12, 1 EA/Case

3M Product Number 39113 3M ID 7010342243 UPC 00051131372467

Details

1.73 in. x 3.66 in. ADF viewing area
Variable shade 8-12
Low battery indicator

Typical properties

ADF Dark State Shades
Variable 8-12
ADF Shade Range
Variable 8-12
ADF Viewing Area (Metric)
44 mm x 93 mm
ADF Viewing Area (hwx)
1.73x3.66in
Brands
Speedglas™
Case Quantity
1
Dark Shades
Shades 8-12
Features
100 Series Accessory, ADF Access

3M™ DBI-SALA® Smart Lock Self-Retracting Lifeline 3503804, Stainless Steel Cable, Blue, 20 ft. (6m) 1 Ea/Case

Part Number 3503804 3M Product Number 3503804 3M ID 7100204321

Details

Available in multiple lifeline lengths and lifeline material configurations
Lightweight thermoplastic housing with built in carrying handle
Swiveling anchorage point and carabiner included
Patent pending dual label system located within ergonomic cable bumper stop to simplify inspections and reduce the need for replacement
Swiveling snap hook with impact indicator
RFID located in cable handle

Typical properties

Anchor Connection Type
Swivel Snap Hook
Anchor Hook Material
Stainless Steel
Brands
DBI-SALA®
Carabiner/Hook Material
Stainless Steel
Connected Safety ID Equipped
Yes
Connector
Swivel Hook
Dimensions
23.5" x 9" x 4"
Features
420 lb Capacity

Dimensions and Classifications

Overall Length (Imperial)
20 ft

3M™ DBI-SALA® Smart Lock Edge Self Retracting Lifeline 3503881, Galvanized Cable, Steel Swivel Snap Hook, 30 ft, Class 2

3M Product Number 3503881 3M ID 7100311417 UPC 00648250239483

Details

Available in multiple lifeline lengths and lifeline material configurations
Lightweight thermoplastic housing with built in carrying handle
Swiveling anchorage point and carabiner included
Patent pending dual label system located within ergonomic cable bumper stop to simplify inspections and reduce the need for replacement
Swiveling snap hook with impact indicator
RFID located in cable handle

Typical properties

ANSI Class Level
Class 2
Anchor Connection Type
Carabiner
Anchor Hook Material
Zinc Plated Steel
Average Arrest Force (Imperial)
1125 lbf (ANSI), 1125 lbf (OSHA 130 lb - 310 lb)
Average Arrest Force (Metric)
5 kN (ANSI), 5 kN (OSHA 130 lb - 310 l

Dimensions and Classifications

Overall Length (Imperial)
30 ft
Overall Length (Metric)
9.14 m

3M™ DBI-SALA® Smart Lock Edge Self Retracting Lifeline 3503880, Galvanized Cable, Steel Swivel Snap Hook, 20 ft, Class 2

3M Product Number 3503880 3M ID 7100311415 UPC 00648250239476

Details

Available in multiple lifeline lengths and lifeline material configurations
Lightweight thermoplastic housing with built in carrying handle
Swiveling anchorage point and carabiner included
Patent pending dual label system located within ergonomic cable bumper stop to simplify inspections and reduce the need for replacement
Swiveling snap hook with impact indicator
RFID located in cable handle

Typical properties

ANSI Class Level
Class 2
Anchor Connection Type
Carabiner
Anchor Hook Material
Zinc Plated Steel
Average Arrest Force (Imperial)
1125 lbf (ANSI), 1125 lbf (OSHA 130 lb - 310 lb)
Average Arrest Force (Metric)
5 kN (ANSI), 5 kN (OSHA 130 lb - 310 l

Dimensions and Classifications

Overall Length (Imperial)
20 ft
Overall Length (Metric)
6.09 m

3M™ DBI-SALA® Smart Lock Self-Retracting Lifeline 3503874, 30 ft, Galvanized Cable, Class 1

3M Product Number 3503874 3M ID 7100306994 UPC 00648250239414

Details

Available in multiple lifeline lengths and lifeline material configurations
Lightweight thermoplastic housing with built in carrying handle
Swiveling anchorage point and carabiner included
Patent pending dual label system located within ergonomic cable bumper stop to simplify inspections and reduce the need for replacement
Swiveling snap hook with impact indicator
RFID located in cable handle

Typical properties

ANSI Class Level
Class 1
Anchor Connection Type
Carabiner
Anchor Hook Material
Zinc Plated Steel
Anchor Hook Material
Zinc Plated Steel
Average Arrest Force (Imperial)
1125 lbf (ANSI), 1125 lbf (OSHA 130 lb - 310 lb)
Average Arrest Force (Metric)

Dimensions and Classifications

Overall Length (Imperial)
30 ft
Overall Length (Metric)
9.14 m

3M™ DBI-SALA® Smart Lock Edge Modular Self Retracting Lifeline 3503850, Galvanized Cable, Steel Swivel Snap Hook, 20 ft, Class 2

3M Product Number 3503850 3M ID 7100311416 UPC 00840779195923

Details

Available in multiple lifeline lengths and lifeline material configurations
Lightweight thermoplastic housing with built in carrying handle
Swiveling anchorage point and carabiner included
Patent pending dual label system located within ergonomic cable bumper stop to simplify inspections and reduce the need for replacement
Swiveling snap hook with impact indicator
RFID located in cable handle

Typical properties

ANSI Class Level
Class 2
Anchor Connection Type
Carabiner
Anchor Hook Material
Zinc Plated Steel
Average Arrest Force (Imperial)
1125 lbf (ANSI), 1125 lbf (OSHA 130 lb - 310 lb)
Average Arrest Force (Metric)
5 kN (ANSI), 5 kN (OSHA 130 lb - 310 l

Dimensions and Classifications

Overall Length (Imperial)
20 ft
Overall Length (Metric)
6.1 m

3M™ DBI-SALA® Smart Lock Edge Modular Self Retracting Lifeline 3503890, Galvanized Cable, Steel Swivel Snap Hook, 30 ft, Class 2

3M Product Number 3503890 3M ID 7100311418 UPC 00648250244531

Details

Available in multiple lifeline lengths and lifeline material configurations
Lightweight thermoplastic housing with built in carrying handle
Swiveling anchorage point and carabiner included
Patent pending dual label system located within ergonomic cable bumper stop to simplify inspections and reduce the need for replacement
Swiveling snap hook with impact indicator
RFID located in cable handle

Typical properties

ANSI Class Level
Class 2
Anchor Connection Type
Carabiner
Anchor Hook Material
Zinc Plated Steel
Average Arrest Force (Imperial)
1125 lbf (ANSI), 1125 lbf (OSHA 130 lb - 310 lb)
Average Arrest Force (Metric)
5 kN (ANSI), 5 kN (OSHA 130 lb - 310 l

Dimensions and Classifications

Overall Length (Imperial)
30 ft
Overall Length (Metric)
9.1 m

3M™ DBI-SALA® Smart Lock Self-Retracting Lifeline 3503875, Stainless Steel Cable, 25 ft. (7.6 m)

3M Product Number 3503875 3M ID 7100307004 UPC 00648250239421

Details

Available in multiple lifeline lengths and lifeline material configurations
Lightweight thermoplastic housing with built in carrying handle
Swiveling anchorage point and carabiner included
Patent pending dual label system located within ergonomic cable bumper stop to
simplify inspections and reduce the need for replacement
Swiveling snap hook with impact indicator
RFID located in cable handle

Typical properties

ANSI Class Level
Class 1
Anchor Connection Type
Swivel Snap Hook
Anchor Hook Material
Zinc Plated Steel
Anchor Hook Material
Stainless Steel
Average Arrest Force (Imperial)
1125 lbf (ANSI), 1125 lbf (OSHA 130 lb - 310 lb)
Average Arrest Force (M)

Dimensions and Classifications

Overall Length (Imperial)
25 ft
Overall Length (Metric)
7.62 m

3M™ DBI-SALA® Standing Seam Roof Anchor 2190073

Part Number 2190073 3M Product Number 2190073 3M ID 7100231994

Details

Durable materials and hardware designed to help stand up to harsh working conditions
Compatible with various fall arrest systems, not compliant for use with Horizontal Lifelines
Suitable for use in general industrial and construction industries
Compact, lightweight design
Meets the requirements for 29 CFR OSHA 1910.140 and 29 CFR OSHA 1926.502
Features corrosion-resistant, steel and aluminum construction for durability
This safety equipment is designed for use with additional personal protective equipment (PPE)
The lightweight anchor system installs in minutes and restricts damage the rooftop. Installs to flat or sloped standing seam roofs. System clamps to standing seams without special tools, providing an anchorage point for an SRL, including the 3M™ DBI-SALA® Smart Lock Self-Retracting Lifeline
Built-in non-penetrating clamp design with four seam clamps allow for quick attachment without damaging the roof
Slide on the tube legs fit 12,24, 30, 32 and 36 in. seam spacing (30.5, 61, 76.2, 81.3 and 91.4 cm)
Portable and Reusable. Anchor can be removed and simply reinstalled in a new location for added jobsite flexibility

Typical properties

Anchor Hook Material
Metal
Anchor Install Type
Reusable
Brands
DBI-SALA®
Case Quantity
1 EA
Connected Safety ID Equipped
No
For Use With
3M™ DBI-SALA® Smart Lock Self-Retracting Lifeline (SRL)
Housing Material
Aluminum & Stainless Steel
Hous

3M™ DBI-SALA® Lad-Saf™ Swaged Cable 6104260, 3/8 Inch, 1x7, Galvanized Steel, 260 FT

Part Number 6104260 3M Product Number 6104260 3M ID 7100184410

Details

Robust cable tensioning and termination
Durable, high-strength steel construction that allows for maintenance-free longevity
Cable comes pre-cut and swaged, allowed for quick and easy installation and tensioning
Comes in stainless or galvanized steel, and in 1x7 or 7x19 versions

Typical properties

Brands
DBI-SALA®
Cable Preformation
Left, Regular Lay
Cable Strand
1 x 7
Case Quantity
1
Connected Safety ID Equipped
No
Install Type
Permanent
Lifeline Length (Imperial)
260 ft
Lifeline Length (Metric)
79.24 m
Lifeline Material
Galvanize

Dimensions and Classifications

Overall Width (Imperial)
0.375 in
Overall Width (Metric)
9.525 mm

3M™ DBI-SALA® Lad-Saf™ Swaged Cable 6104190, 3/8 Inch, 1x7, Galvanized Steel, 190 FT

Part Number 6104190 3M Product Number 6104190 3M ID 7100184406

Details

Robust cable tensioning and termination

Durable, high-strength steel construction that allows for maintenance-free longevity

Cable comes pre-cut and swaged, allowed for quick and easy installation and tensioning

Comes in stainless or galvanized steel, and in 1x7 or 7x19 versions

Typical properties

Brands

DBI-SALA®

Cable Preformation

Left, Regular Lay

Cable Strand

1 x 7

Case Quantity

1

Connected Safety ID Equipped

No

Install Type

Permanent

Lifeline Length (Imperial)

190 ft

Lifeline Length (Metric)

57.91 m

Lifeline Material

Galvanize

Dimensions and Classifications

Overall Width (Imperial)

0.375 in

Overall Width (Metric)

9.525 mm

3M™ DBI-SALA® Lad-Saf™ Swaged Cable 6104200, 3/8 Inch, 1x7, Galvanized Steel, 200 FT

Part Number 6104200 3M Product Number 6104200 3M ID 7100184407

Details

Robust cable tensioning and termination
Durable, high-strength steel construction that allows for maintenance-free longevity
Cable comes pre-cut and swaged, allowed for quick and easy installation and tensioning
Comes in stainless or galvanized steel, and in 1x7 or 7x19 versions

Typical properties

Brands
DBI-SALA®
Cable Preformation
Left, Regular Lay
Cable Strand
1 x 7
Case Quantity
1
Connected Safety ID Equipped
No
Install Type
Permanent
Lifeline Length (Imperial)
200 ft
Lifeline Length (Metric)
60.96 m
Lifeline Material
Galvanize

Dimensions and Classifications

Overall Width (Imperial)
0.375 in
Overall Width (Metric)
9.525 mm

3M™ DBI-SALA® Lad-Saf™ Swaged Cable 6104220, 3/8 Inch, 1x7, Galvanized Steel, 220 FT

Part Number 6104220 3M Product Number 6104220 3M ID 7100184408

Details

Robust cable tensioning and termination

Durable, high-strength steel construction that allows for maintenance-free longevity

Cable comes pre-cut and swaged, allowed for quick and easy installation and tensioning

Comes in stainless or galvanized steel, and in 1x7 or 7x19 versions

Typical properties

Brands

DBI-SALA®

Cable Preformation

Left, Regular Lay

Cable Strand

1 x 7

Case Quantity

1

Connected Safety ID Equipped

No

Install Type

Permanent

Lifeline Length (Imperial)

220 ft

Lifeline Length (Metric)

67.05 m

Lifeline Material

Galvanize

Dimensions and Classifications

Overall Width (Imperial)

0.375 in

Overall Width (Metric)

9.525 mm

3M™ DBI-SALA® Lad-Saf™ Swaged Cable 6104160, 3/8 Inch, 1x7, Galvanized Steel, 160 FT

Part Number 6104160 3M Product Number 6104160 3M ID 7100184403

Details

Robust cable tensioning and termination
Durable, high-strength steel construction that allows for maintenance-free longevity
Cable comes pre-cut and swaged, allowed for quick and easy installation and tensioning
Comes in stainless or galvanized steel, and in 1x7 or 7x19 versions

Typical properties

Brands
DBI-SALA®
Cable Preformation
Left, Regular Lay
Cable Strand
1 x 7
Case Quantity
1
Connected Safety ID Equipped
No
Install Type
Permanent
Lifeline Length (Imperial)
160 ft
Lifeline Length (Metric)
48.76 m
Lifeline Material
Galvanize

Dimensions and Classifications

Overall Width (Imperial)
0.375 in
Overall Width (Metric)
9.525 mm

3M™ DBI-SALA® Lad-Saf™ Swaged Cable 6104170, 3/8 Inch, 1x7, Galvanized Steel, 170 FT

Part Number 6104170 3M Product Number 6104170 3M ID 7100184404

Details

Robust cable tensioning and termination

Durable, high-strength steel construction that allows for maintenance-free longevity

Cable comes pre-cut and swaged, allowed for quick and easy installation and tensioning

Comes in stainless or galvanized steel, and in 1x7 or 7x19 versions

Typical properties

Brands

DBI-SALA®

Cable Preformation

Left, Regular Lay

Cable Strand

1 x 7

Case Quantity

1

Connected Safety ID Equipped

No

Install Type

Permanent

Lifeline Length (Imperial)

170 ft

Lifeline Length (Metric)

51.81 m

Lifeline Material

Galvanize

Dimensions and Classifications

Overall Width (Imperial)

0.375 in

Overall Width (Metric)

9.525 mm

3M™ DBI-SALA® Lad-Saf™ Swaged Cable 6104130, 3/8 Inch, 1x7, Galvanized Steel, 130 FT

Part Number 6104130 3M Product Number 6104130 3M ID 7100184400

Details

Robust cable tensioning and termination
Durable, high-strength steel construction that allows for maintenance-free longevity
Cable comes pre-cut and swaged, allowed for quick and easy installation and tensioning
Comes in stainless or galvanized steel, and in 1x7 or 7x19 versions

Typical properties

Brands
DBI-SALA®
Cable Preformation
Left, Regular Lay
Cable Strand
1 x 7
Case Quantity
1
Connected Safety ID Equipped
No
Install Type
Permanent
Lifeline Length (Imperial)
130 ft
Lifeline Length (Metric)
39.62 m
Lifeline Material
Galvanize

Dimensions and Classifications

Overall Width (Imperial)
0.375 in
Overall Width (Metric)
9.525 mm

3M™ DBI-SALA® Lad-Saf™ Swaged Cable 6104075, 3/8 Inch, 1x7, Galvanized Steel, 75 FT

Part Number 6104075 3M Product Number 6104075 3M ID 7100184395

Details

Robust cable tensioning and termination

Durable, high-strength steel construction that allows for maintenance-free longevity

Cable comes pre-cut and swaged, allowed for quick and easy installation and tensioning

Comes in stainless or galvanized steel, and in 1x7 or 7x19 versions

Typical properties

Brands

DBI-SALA®

Cable Preformation

Left, Regular Lay

Cable Strand

1 x 7

Case Quantity

1

Connected Safety ID Equipped

No

Install Type

Permanent

Lifeline Length (Imperial)

75 ft

Lifeline Length (Metric)

22.86 m

Lifeline Material

Galvanized

Dimensions and Classifications

Overall Width (Imperial)

0.375 in

Overall Width (Metric)

9.525 mm

3M™ DBI-SALA® Lad-Saf™ Swaged Cable 6104110, 3/8 Inch, 1x7, Galvanized Steel, 110 FT

Part Number 6104110 3M Product Number 6104110 3M ID 7100184398

Details

Robust cable tensioning and termination

Durable, high-strength steel construction that allows for maintenance-free longevity

Cable comes pre-cut and swaged, allowed for quick and easy installation and tensioning

Comes in stainless or galvanized steel, and in 1x7 or 7x19 versions

Typical properties

Brands

DBI-SALA®

Cable Preformation

Left, Regular Lay

Cable Strand

1 x 7

Case Quantity

1

Connected Safety ID Equipped

No

Install Type

Permanent

Lifeline Length (Imperial)

110 ft

Lifeline Length (Metric)

33.52 m

Lifeline Material

Galvanize

Dimensions and Classifications

Overall Width (Imperial)

0.375 in

Overall Width (Metric)

9.525 mm

3M™ DBI-SALA® Lad-Saf™ Swaged Cable 6104045, 3/8 Inch, 1x7, Galvanized Steel, 45 FT

Part Number 6104045 3M Product Number 6104045 3M ID 7100184392

Details

Robust cable tensioning and termination

Durable, high-strength steel construction that allows for maintenance-free longevity

Cable comes pre-cut and swaged, allowed for quick and easy installation and tensioning

Comes in stainless or galvanized steel, and in 1x7 or 7x19 versions

Typical properties

Brands

DBI-SALA®

Cable Preformation

Left, Regular Lay

Cable Strand

1 x 7

Case Quantity

1

Connected Safety ID Equipped

No

Install Type

Permanent

Lifeline Length (Imperial)

45 ft

Lifeline Length (Metric)

13.71 m

Lifeline Material

Galvanized

Dimensions and Classifications

Overall Width (Imperial)

0.375 in

Overall Width (Metric)

9.525 mm

3M™ DBI-SALA® Lad-Saf™ Swaged Cable 6104055, 3/8 Inch, 1x7, Galvanized Steel, 55 FT

Part Number 6104055 3M Product Number 6104055 3M ID 7100184393

Details

Robust cable tensioning and termination

Durable, high-strength steel construction that allows for maintenance-free longevity

Cable comes pre-cut and swaged, allowed for quick and easy installation and tensioning

Comes in stainless or galvanized steel, and in 1x7 or 7x19 versions

Typical properties

Brands

DBI-SALA®

Cable Preformation

Left, Regular Lay

Cable Strand

1 x 7

Case Quantity

1

Connected Safety ID Equipped

No

Install Type

Permanent

Lifeline Length (Imperial)

55 ft

Lifeline Length (Metric)

16.76 m

Lifeline Material

Galvanized

Dimensions and Classifications

Overall Width (Imperial)

0.375 in

Overall Width (Metric)

9.525 mm

3M™ DBI-SALA® Lad-Saf™ Swaged Cable 6104015, 3/8 Inch, 1x7, Galvanized Steel, 15 FT

Part Number 6104015 3M Product Number 6104015 3M ID 7100184389

Details

Robust cable tensioning and termination
Durable, high-strength steel construction that allows for maintenance-free longevity
Cable comes pre-cut and swaged, allowed for quick and easy installation and tensioning
Comes in stainless or galvanized steel, and in 1x7 or 7x19 versions

Typical properties

Brands
DBI-SALA®
Cable Preformation
Left, Regular Lay
Cable Strand
1 x 7
Case Quantity
1
Connected Safety ID Equipped
No
Install Type
Permanent
Lifeline Length (Imperial)
15 ft
Lifeline Length (Metric)
4.57 m
Lifeline Material
Galvanized

Dimensions and Classifications

Overall Width (Imperial)
0.375 in
Overall Width (Metric)
9.525 mm

3M™ DBI-SALA® Lad-Saf™ Swaged Cable 6104025, 3/8 Inch, 1x7, Galvanized Steel, 25 FT

Part Number 6104025 3M Product Number 6104025 3M ID 7100184390

Details

Robust cable tensioning and termination
Durable, high-strength steel construction that allows for maintenance-free longevity
Cable comes pre-cut and swaged, allowed for quick and easy installation and tensioning
Comes in stainless or galvanized steel, and in 1x7 or 7x19 versions

Typical properties

Brands
DBI-SALA®
Cable Preformation
Left, Regular Lay
Cable Strand
1 x 7
Case Quantity
1
Connected Safety ID Equipped
No
Install Type
Permanent
Lifeline Length (Imperial)
25 ft
Lifeline Length (Metric)
7.62 m
Lifeline Material
Galvanized

Dimensions and Classifications

Overall Width (Imperial)
0.375 in
Overall Width (Metric)
9.525 mm

3M™ DBI-SALA® Lad-Saf™ Swaged Cable 6105160, 3/8 Inch, 1x7, Stainless Steel, 160 FT

Part Number 6105160 3M Product Number 6105160 3M ID 7100184427

Details

Robust cable tensioning and termination

Durable, high-strength steel construction that allows for maintenance-free longevity

Cable comes pre-cut and swaged, allowed for quick and easy installation and tensioning

Comes in stainless or galvanized steel, and in 1x7 or 7x19 versions

Typical properties

Anchor Connection Type

Swage

Brands

DBI-SALA®

Cable Preformation

Left, Regular Lay

Cable Strand

1 x 7

Case Quantity

1

Connected Safety ID Equipped

No

Install Type

Permanent

Lifeline Length (Imperial)

160 ft

Lifeline Length (Metric)

48.76

Dimensions and Classifications

Overall Width (Imperial)

0.375 in

Overall Width (Metric)

9.525 mm

3M™ DBI-SALA® Lad-Saf™ Swaged Cable 6105055, 3/8 Inch, 1x7, Stainless Steel, 55 FT

Part Number 6105055 3M Product Number 6105055 3M ID 7100184417

Details

Robust cable tensioning and termination

Durable, high-strength steel construction that allows for maintenance-free longevity

Cable comes pre-cut and swaged, allowed for quick and easy installation and tensioning

Comes in stainless or galvanized steel, and in 1x7 or 7x19 versions

Typical properties

Anchor Connection Type

Swage

Brands

DBI-SALA®

Cable Preformation

Left, Regular Lay

Cable Strand

1 x 7

Case Quantity

1

Connected Safety ID Equipped

No

Install Type

Permanent

Lifeline Length (Imperial)

55 ft

Lifeline Length (Metric)

16.76 m

Dimensions and Classifications

Overall Width (Imperial)

0.375 in

Overall Width (Metric)

9.525 mm

3M™ DBI-SALA® Lad-Saf™ Swaged Cable 6105075, 3/8 Inch, 1x7, Stainless Steel, 75 FT

Part Number 6105075 3M Product Number 6105075 3M ID 7100184419

Details

Robust cable tensioning and termination
Durable, high-strength steel construction that allows for maintenance-free longevity
Cable comes pre-cut and swaged, allowed for quick and easy installation and tensioning
Comes in stainless or galvanized steel, and in 1x7 or 7x19 versions

Typical properties

Brands
DBI-SALA®
Cable Preformation
Left, Regular Lay
Cable Strand
1 x 7
Case Quantity
1
Connected Safety ID Equipped
No
Install Type
Permanent
Lifeline Length (Imperial)
75 ft
Lifeline Length (Metric)
22.86 m
Lifeline Material
Stainless

Dimensions and Classifications

Overall Width (Imperial)
0.375 in
Overall Width (Metric)
9.525 mm

3M™ DBI-SALA® Lad-Saf™ Swaged Cable 6105085, 3/8 Inch, 1x7, Stainless Steel, 85 FT

Part Number 6105085 3M Product Number 6105085 3M ID 7100184420

Details

Robust cable tensioning and termination
Durable, high-strength steel construction that allows for maintenance-free longevity
Cable comes pre-cut and swaged, allowed for quick and easy installation and tensioning
Comes in stainless or galvanized steel, and in 1x7 or 7x19 versions

Typical properties

Brands
DBI-SALA®
Cable Preformation
Left, Regular Lay
Cable Strand
1 x 7
Case Quantity
1
Connected Safety ID Equipped
No
Install Type
Permanent
Lifeline Length (Imperial)
85 ft
Lifeline Length (Metric)
25.9 m
Lifeline Material
Stainless S

Dimensions and Classifications

Overall Width (Imperial)
0.375 in
Overall Width (Metric)
9.525 mm

3M™ DBI-SALA® Lad-Saf™ Swaged Cable 6105035, 3/8 Inch, 1x7, Stainless Steel, 35 FT

Part Number 6105035 3M Product Number 6105035 3M ID 7100184415

Details

Robust cable tensioning and termination
Durable, high-strength steel construction that allows for maintenance-free longevity
Cable comes pre-cut and swaged, allowed for quick and easy installation and tensioning
Comes in stainless or galvanized steel, and in 1x7 or 7x19 versions

Typical properties

Anchor Connection Type
Swage
Brands
DBI-SALA®
Cable Preformation
Left, Regular Lay
Cable Strand
1 x 7
Case Quantity
1
Connected Safety ID Equipped
No
Install Type
Permanent
Lifeline Length (Imperial)
35 ft
Lifeline Length (Metric)
10.66 m

Dimensions and Classifications

Overall Width (Imperial)
0.375 in
Overall Width (Metric)
9.525 mm

3M™ DBI-SALA® Lad-Saf™ Swaged Cable 6105045, 3/8 Inch, 1x7, Stainless Steel, 45 FT

Part Number 6105045 3M Product Number 6105045 3M ID 7100184416

Details

Robust cable tensioning and termination
Durable, high-strength steel construction that allows for maintenance-free longevity
Cable comes pre-cut and swaged, allowed for quick and easy installation and tensioning
Comes in stainless or galvanized steel, and in 1x7 or 7x19 versions

Typical properties

Anchor Connection Type
Swage
Brands
DBI-SALA®
Cable Preformation
Left, Regular Lay
Cable Strand
1 x 7
Case Quantity
1
Connected Safety ID Equipped
No
Install Type
Permanent
Lifeline Length (Imperial)
45 ft
Lifeline Length (Metric)
13.71 m

Dimensions and Classifications

Overall Width (Imperial)
0.375 in
Overall Width (Metric)
9.525 mm

3M™ DBI-SALA® Lad-Saf™ Swaged Cable 6106045, 3/8 Inch, 7x19, Galvanized Steel, 45 FT

3M Product Number 6106045 3M ID 7100184440 UPC 00840779165810

Details

Robust cable tensioning and termination

Durable, high-strength steel construction that allows for maintenance-free longevity

Cable comes pre-cut and swaged, allowed for quick and easy installation and tensioning

Comes in stainless or galvanized steel, and in 1x7 or 7x19 versions

Typical properties

Brands

DBI-SALA®

Cable Preformation

Right. Regular Lay

Cable Strand

7 x 19

Case Quantity

1

Connected Safety ID Equipped

No

Install Type

Permanent

Lifeline Length (Imperial)

45 ft

Lifeline Length (Metric)

13.71 m

Lifeline Material

Galvaniz

Dimensions and Classifications

Overall Width (Imperial)

0.375 in

Overall Width (Metric)

9.525 mm

3M™ DBI-SALA® Lad-Saf™ Swaged Cable 6105080, 3/8 Inch, 1x7, Stainless Steel, 80 FT

Part Number 6105080 3M Product Number 6105080 3M ID 7100184367

Details

Robust cable tensioning and termination
Durable, high-strength steel construction that allows for maintenance-free longevity
Cable comes pre-cut and swaged, allowed for quick and easy installation and tensioning
Comes in stainless or galvanized steel, and in 1x7 or 7x19 versions

Typical properties

Brands
DBI-SALA®
Cable Preformation
Left, Regular Lay
Cable Strand
1 x 7
Case Quantity
1
Connected Safety ID Equipped
No
Install Type
Permanent
Lifeline Length (Imperial)
80 ft
Lifeline Length (Metric)
24.38 m
Lifeline Material
Stainless

Dimensions and Classifications

Overall Width (Imperial)
0.375 in
Overall Width (Metric)
9.525 mm

3M™ DBI-SALA® Lad-Saf™ Swaged Cable 6104070, 3/8 Inch, 1x7, Galvanized Steel, 70 FT

Part Number 6104070 3M Product Number 6104070 3M ID 7100184361

Details

Robust cable tensioning and termination
Durable, high-strength steel construction that allows for maintenance-free longevity
Cable comes pre-cut and swaged, allowed for quick and easy installation and tensioning
Comes in stainless or galvanized steel, and in 1x7 or 7x19 versions

Typical properties

Anchor Connection Type
Bracket/Nut
Brands
DBI-SALA®
Cable Preformation
Left, Regular Lay
Cable Strand
1 x 7
Case Quantity
1
Connected Safety ID Equipped
No
Install Type
Permanent
Lifeline Length (Imperial)
70 ft
Lifeline Length (Metric)
2

Dimensions and Classifications

Overall Width (Imperial)
0.375 in
Overall Width (Metric)
9.525 mm

3M™ DBI-SALA® Lad-Saf™ Swaged Cable 6104080, 3/8 Inch, 1x7, Galvanized Steel, 80 FT

Part Number 6104080 3M Product Number 6104080 3M ID 7100184362

Details

Robust cable tensioning and termination

Durable, high-strength steel construction that allows for maintenance-free longevity

Cable comes pre-cut and swaged, allowed for quick and easy installation and tensioning

Comes in stainless or galvanized steel, and in 1x7 or 7x19 versions

Typical properties

Brands

DBI-SALA®

Cable Preformation

Left, Regular Lay

Cable Strand

1 x 7

Case Quantity

1

Connected Safety ID Equipped

No

Install Type

Permanent

Lifeline Length (Imperial)

80 ft

Lifeline Length (Metric)

24.38 m

Lifeline Material

Galvanized

Dimensions and Classifications

Overall Width (Imperial)

0.375 in

Overall Width (Metric)

9.525 mm

3M™ DBI-SALA® Lad-Saf™ Swaged Cable 6107150, 3/8 Inch, 7x19, Stainless Steel, 150 FT

Part Number 6107150 3M Product Number 6107150 3M ID 7100184484

Details

Robust cable tensioning and termination

Durable, high-strength steel construction that allows for maintenance-free longevity

Cable comes pre-cut and swaged, allowed for quick and easy installation and tensioning

Comes in stainless or galvanized steel, and in 1x7 or 7x19 versions

Typical properties

Anchor Connection Type

Swage

Brands

DBI-SALA®

Cable Preformation

Right. Regular Lay

Cable Strand

7 x 19

Case Quantity

1

Connected Safety ID Equipped

No

Install Type

Permanent

Lifeline Length (Imperial)

150 ft

Lifeline Length (Metric)

45.7

Dimensions and Classifications

Overall Width (Imperial)

0.375 in

Overall Width (Metric)

9.525 mm

3M™ DBI-SALA® Lad-Saf™ Swaged Cable 6104090, 3/8 Inch, 1x7, Galvanized Steel, 90 FT

Part Number 6104090 3M Product Number 6104090 3M ID 7100184363

Details

Robust cable tensioning and termination

Durable, high-strength steel construction that allows for maintenance-free longevity

Cable comes pre-cut and swaged, allowed for quick and easy installation and tensioning

Comes in stainless or galvanized steel, and in 1x7 or 7x19 versions

Typical properties

Brands

DBI-SALA®

Cable Preformation

Left, Regular Lay

Cable Strand

1 x 7

Case Quantity

1

Connected Safety ID Equipped

No

Install Type

Permanent

Lifeline Length (Imperial)

90 ft

Lifeline Length (Metric)

27.43 m

Lifeline Material

Galvanized

Dimensions and Classifications

Overall Width (Imperial)

0.375 in

Overall Width (Metric)

9.525 mm

3M™ DBI-SALA® Lad-Saf™ Swaged Cable 6107050, 3/8 Inch, 7x19, Stainless Steel, 50 FT

Part Number 6107050 3M Product Number 6107050 3M ID 7100184359

Details

Robust cable tensioning and termination

Durable, high-strength steel construction that allows for maintenance-free longevity

Cable comes pre-cut and swaged, allowed for quick and easy installation and tensioning

Comes in stainless or galvanized steel, and in 1x7 or 7x19 versions

Typical properties

Brands

DBI-SALA®

Cable Preformation

Right. Regular Lay

Cable Strand

7 x 19

Case Quantity

1

Connected Safety ID Equipped

No

Install Type

Permanent

Lifeline Length (Imperial)

50 ft

Lifeline Length (Metric)

15.24 m

Lifeline Material

Stainles

Dimensions and Classifications

Overall Width (Imperial)

0.375 in

Overall Width (Metric)

9.525 mm

3M™ DBI-SALA® Lad-Saf™ Swaged Cable 6104060, 3/8 Inch, 1x7, Galvanized Steel, 60 FT

Part Number 6104060 3M Product Number 6104060 3M ID 7100184360

Details

Robust cable tensioning and termination

Durable, high-strength steel construction that allows for maintenance-free longevity

Cable comes pre-cut and swaged, allowed for quick and easy installation and tensioning

Comes in stainless or galvanized steel, and in 1x7 or 7x19 versions

Typical properties

Brands

DBI-SALA®

Cable Preformation

Left, Regular Lay

Cable Strand

1 x 7

Case Quantity

1

Connected Safety ID Equipped

No

Install Type

Permanent

Lifeline Length (Imperial)

60 ft

Lifeline Length (Metric)

18.28 m

Lifeline Material

Galvanized

Dimensions and Classifications

Overall Width (Imperial)

0.375 in

Overall Width (Metric)

9.525 mm

3M™ DBI-SALA® Lad-Saf™ Swaged Cable 6106050, 3/8 Inch, 7x19, Galvanized Steel, 50 FT

3M Product Number 6106050 3M ID 7100184354 UPC 00840779152995

Details

Robust cable tensioning and termination

Durable, high-strength steel construction that allows for maintenance-free longevity

Cable comes pre-cut and swaged, allowed for quick and easy installation and tensioning

Comes in stainless or galvanized steel, and in 1x7 or 7x19 versions

Typical properties

Anchor Connection Type

Swage

Brands

DBI-SALA®

Cable Preformation

Right. Regular Lay

Cable Strand

7 x 19

Case Quantity

1

Connected Safety ID Equipped

No

Install Type

Permanent

Lifeline Length (Imperial)

50 ft

Lifeline Length (Metric)

15.24

Dimensions and Classifications

Overall Width (Imperial)

0.375 in

Overall Width (Metric)

9.525 mm

3M™ DBI-SALA® Lad-Saf™ Swaged Cable 6107030, 3/8 Inch, 7x19, Stainless Steel, 30 FT

Part Number 6107030 3M Product Number 6107030 3M ID 7100184357

Details

Robust cable tensioning and termination

Durable, high-strength steel construction that allows for maintenance-free longevity

Cable comes pre-cut and swaged, allowed for quick and easy installation and tensioning

Comes in stainless or galvanized steel, and in 1x7 or 7x19 versions

Typical properties

Brands

DBI-SALA®

Cable Preformation

Right. Regular Lay

Cable Strand

7 x 19

Case Quantity

1

Connected Safety ID Equipped

No

Install Type

Permanent

Lifeline Length (Imperial)

30 ft

Lifeline Length (Metric)

9.14 m

Lifeline Material

Stainless

Dimensions and Classifications

Overall Width (Imperial)

0.375 in

Overall Width (Metric)

9.525 mm

3M™ DBI-SALA® Lad-Saf™ Swaged Cable 6105030, 3/8 Inch, 1x7, Stainless Steel, 30 FT

Part Number 6105030 3M Product Number 6105030 3M ID 7100184347

Details

Robust cable tensioning and termination
Durable, high-strength steel construction that allows for maintenance-free longevity
Cable comes pre-cut and swaged, allowed for quick and easy installation and tensioning
Comes in stainless or galvanized steel, and in 1x7 or 7x19 versions

Typical properties

Anchor Connection Type
Swage
Brands
DBI-SALA®
Cable Preformation
Left, Regular Lay
Cable Strand
1 x 7
Case Quantity
1
Connected Safety ID Equipped
No
Install Type
Permanent
Lifeline Length (Imperial)
30 ft
Lifeline Length (Metric)
9.14 m

Dimensions and Classifications

Overall Width (Imperial)
0.375 in
Overall Width (Metric)
9.525 mm

3M™ DBI-SALA® Lad-Saf™ Swaged Cable 6105050, 3/8 Inch, 1x7, Stainless Steel, 50 FT

Part Number 6105050 3M Product Number 6105050 3M ID 7100184349

Details

Robust cable tensioning and termination

Durable, high-strength steel construction that allows for maintenance-free longevity

Cable comes pre-cut and swaged, allowed for quick and easy installation and tensioning

Comes in stainless or galvanized steel, and in 1x7 or 7x19 versions

Typical properties

Anchor Connection Type

Swage

Brands

DBI-SALA®

Cable Preformation

Left, Regular Lay

Cable Strand

1 x 7

Case Quantity

1

Connected Safety ID Equipped

No

Install Type

Permanent

Lifeline Length (Imperial)

50 ft

Lifeline Length (Metric)

15.24 m

Dimensions and Classifications

Overall Width (Imperial)

0.375 in

Overall Width (Metric)

9.525 mm

3M™ DBI-SALA® Lad-Saf™ Swaged Cable 6107060, 3/8 Inch, 7x19, Stainless Steel, 60 FT

Part Number 6107060 3M Product Number 6107060 3M ID 7100184471

Details

Robust cable tensioning and termination

Durable, high-strength steel construction that allows for maintenance-free longevity

Cable comes pre-cut and swaged, allowed for quick and easy installation and tensioning

Comes in stainless or galvanized steel, and in 1x7 or 7x19 versions

Typical properties

Anchor Connection Type

Swage

Brands

DBI-SALA®

Cable Preformation

Right. Regular Lay

Cable Strand

7 x 19

Case Quantity

1

Connected Safety ID Equipped

No

Install Type

Permanent

Lifeline Length (Imperial)

60 ft

Lifeline Length (Metric)

18.28

Dimensions and Classifications

Overall Width (Imperial)

0.375 in

Overall Width (Metric)

9.525 mm

3M™ DBI-SALA® Lad-Saf™ Swaged Cable 6106010, 3/8 Inch, 7x19, Galvanized Steel, 10 FT

3M Product Number 6106010 3M ID 7100184350 UPC 00840779152957

Details

Robust cable tensioning and termination

Durable, high-strength steel construction that allows for maintenance-free longevity

Cable comes pre-cut and swaged, allowed for quick and easy installation and tensioning

Comes in stainless or galvanized steel, and in 1x7 or 7x19 versions

Typical properties

Brands

DBI-SALA®

Cable Preformation

Right. Regular Lay

Cable Strand

7 x 19

Case Quantity

1

Connected Safety ID Equipped

No

Install Type

Permanent

Lifeline Length (Imperial)

10 ft

Lifeline Length (Metric)

3.04 m

Lifeline Material

Galvanize

Dimensions and Classifications

Overall Width (Imperial)

0.375 in

Overall Width (Metric)

9.525 mm

3M™ DBI-SALA® Lad-Saf™ Swaged Cable 6105010, 3/8 Inch, 1x7, Stainless Steel, 10 FT

Part Number 6105010 3M Product Number 6105010 3M ID 7100184345

Details

Robust cable tensioning and termination
Durable, high-strength steel construction that allows for maintenance-free longevity
Cable comes pre-cut and swaged, allowed for quick and easy installation and tensioning
Comes in stainless or galvanized steel, and in 1x7 or 7x19 versions

Typical properties

Brands
DBI-SALA®
Cable Preformation
Left, Regular Lay
Cable Strand
1 x 7
Case Quantity
1
Connected Safety ID Equipped
No
Install Type
Permanent
Lifeline Length (Imperial)
10 ft
Lifeline Length (Metric)
3.04 m
Lifeline Material
Stainless S

Dimensions and Classifications

Overall Width (Imperial)
0.375 in
Overall Width (Metric)
9.525 mm

3M™ DBI-SALA® Lad-Saf™ Swaged Cable 6106240, 3/8 Inch, 7x19, Galvanized Steel, 240 FT

3M Product Number 6106240 3M ID 7100184462 UPC 00840779166039

Details

Robust cable tensioning and termination

Durable, high-strength steel construction that allows for maintenance-free longevity

Cable comes pre-cut and swaged, allowed for quick and easy installation and tensioning

Comes in stainless or galvanized steel, and in 1x7 or 7x19 versions

Typical properties

Brands

DBI-SALA®

Cable Preformation

Right. Regular Lay

Cable Strand

7 x 19

Case Quantity

1

Connected Safety ID Equipped

No

Install Type

Permanent

Lifeline Length (Imperial)

240 ft

Lifeline Length (Metric)

73.15 m

Lifeline Material

Galvani

Dimensions and Classifications

Overall Width (Imperial)

3 in

3M™ DBI-SALA® Lad-Saf™ Swaged Cable 6106180, 3/8 Inch, 7x19, Galvanized Steel, 180 FT

3M Product Number 6106180 3M ID 7100184458 UPC 00840779165995

Details

Robust cable tensioning and termination

Durable, high-strength steel construction that allows for maintenance-free longevity

Cable comes pre-cut and swaged, allowed for quick and easy installation and tensioning

Comes in stainless or galvanized steel, and in 1x7 or 7x19 versions

Typical properties

Brands

DBI-SALA®

Cable Preformation

Right. Regular Lay

Cable Strand

7 x 19

Case Quantity

1

Connected Safety ID Equipped

No

Install Type

Permanent

Lifeline Length (Imperial)

180 ft

Lifeline Length (Metric)

54.86 m

Lifeline Material

Galvani

Dimensions and Classifications

Overall Width (Imperial)

3 in

3M™ DBI-SALA® Lad-Saf™ Swaged Cable 6106200, 3/8 Inch, 7x19, Galvanized Steel, 200 FT

3M Product Number 6106200 3M ID 7100184460 UPC 00840779166015

Details

Robust cable tensioning and termination

Durable, high-strength steel construction that allows for maintenance-free longevity

Cable comes pre-cut and swaged, allowed for quick and easy installation and tensioning

Comes in stainless or galvanized steel, and in 1x7 or 7x19 versions

Typical properties

Brands

DBI-SALA®

Cable Preformation

Right. Regular Lay

Cable Strand

7 x 19

Case Quantity

1

Connected Safety ID Equipped

No

Install Type

Permanent

Lifeline Length (Imperial)

200 ft

Lifeline Length (Metric)

60.96 m

Lifeline Material

Galvani

Dimensions and Classifications

Overall Width (Imperial)

0.375 in

Overall Width (Metric)

9.525 mm

3M™ DBI-SALA® Reusable Compact Roof Anchor 2103677

Part Number 2103677 3M Product Number 2103677 3M ID 7100228427

Details

Durable materials and hardware designed to help stand up to harsh working conditions
Compatible with various fall arrest systems, not compliant for use with Horizontal Lifelines
Suitable for use in general industrial and construction industries
Compact, lightweight design
Meets the requirements for 29 CFR OSHA 1910.140 and 29 CFR OSHA 1926.502
Features corrosion-resistant, steel and aluminum construction for durability
This safety equipment is designed for use with additional personal protective equipment (PPE)
Installs to sloped or flat wood roofs
Includes 3 ea. lag screws for fast and easy installation
Built-in D-ring tie-off point
Portable and reusable

Typical properties

Anchor Install Type
Reusable
Attachment Type
Screw
Brands
DBI-SALA®
Case Quantity
1
Connected Safety ID Equipped
No
Dimensions
9.00x0.25x3.00in
Install Type
Reusable
Material
Steel
Product Color
Black
Product Type
Reusable Compact Roof

3M™ DBI-SALA® Confined Space Integrated Forklift Basket Davit Mase Base 8510568

Part Number 8510568 3M Product Number 8510568 3M ID 7012820528

Details

Accommodates offset davit masts
Model 8510568 features a removable backstop
Slip-resistant finish on walking surface
Spring loaded entry gate
Recommended for use in multiple industries
Aluminum and steel construction
Lightweight, corrosion resistant aluminum construction

Typical properties

Brands
DBI-SALA®
Case Quantity
1
Connected Safety ID Equipped
No
Dimensions
50.00x45.00x84.00lbs
Install Type
Portable
Maximum Number of Users
One
Net Weight (Imperial)
277 lb
Net Weight (Metric)
125.6 kg
Recommended Industry
Construction

3M™ DBI-SALA® Confined Space Permanent Core Mount Sleeve Davit Mast Base 8510110, Stainless Steel

Part Number 8510110 3M Product Number 8510110 3M ID 7100314311

Details

- Slips into 4 in. (10.1 cm) steel or concrete cored hole
- Allows for 360 degree davit mast rotation
- Available in zinc-plated steel and stainless steel
- Recommended for use in multiple industries
- Accommodates offset davit masts
- Permanent installation with standard tools

Typical properties

- Brands
 - DBI-SALA®
- Case Quantity
 - 1
- Connected Safety ID Equipped
 - No
- Dimensions
 - 10.20x10.20x23.60cm
- Install Type
 - Portable
- Net Weight (Imperial)
 - 7.6 lb
- Net Weight (Metric)
 - 3.4 kg
- Product Series
 - Advanced™
- Product Type
 - Core Mount Sleeve Davit Ba

3M™ DBI-SALA® Confined Space Permanent Core Mount Sleeve Davit Mast Base 8510109, Zinc Plated Steel

Part Number 8510109 3M Product Number 8510109 3M ID 7100311206

Details

- Slips into 4 in. (10.1 cm) steel or concrete cored hole
- Allows for 360 degree davit mast rotation
- Available in zinc-plated steel and stainless steel
- Recommended for use in multiple industries
- Accommodates offset davit masts
- Permanent installation with standard tools

Typical properties

- Brands
 - DBI-SALA®
- Case Quantity
 - 1
- Connected Safety ID Equipped
 - No
- Dimensions
 - 4.00x49.00x9.30lbs
- Install Type
 - Portable
- Net Weight (Imperial)
 - 7.6 lb
- Net Weight (Metric)
 - 3.4 kg
- Product Series
 - Advanced™
- Product Type
 - Core Mount Sleeve Davit Bas

3M™ Versaflo™ Battery Attachment Tool TR-838/94244(AAD), for TR-800 PAPR and TR-830 Battery, 1 EA

Part Number 94244 3M Product Number TR-838 3M ID 7100150921

Details

Enables attachment of TR-830 batteries to TR-802N PAPR blower motors

Typical properties

Brands

Versaflo™

Case Quantity

1/pack

Compatible With

3M™ Versaflo™ TR-800 Series Battery

Intrinsically Safe

N/A

Product Series

TR-800, TR-Series

Product Type

Battery Attachment Tool

Recommended Application

Composite Finishing, Final Finish,

3M™ Speedglas™ G5-01 Hinge Mechanism, 46-0400-56

3M Product Number 46-0400-56 3M ID 7100232457 UPC 00638060430668

Details

Replacement spare part to replace hinge mechanism(s)
For maximum safety and comfort, make it a habit to check your equipment regularly
Replace worn out or damaged parts

Typical properties

Brands
Speedglas™
Compatible Welding Helmet
G5-01 Welding Helmets
Product Series
G5
Product Type
Pivot & Sliding Mechanism
Recommended Application
Grinding, Metal Processing, Metal Repair, Welding
Recommended Industry
General Manufacturing, Hea

3M™ Speedglas™ 9100MP Welding Helmet 27-0099-35SW, with Hard Hat and SideWindows, No ADF, 1 EA/Case

3M Product Number 27-0099-35SW 3M ID 7000128221 UPC 00051141558103

Details

9100 MP Headtop
No ADF Included
Flip up assembly for grinding and prep work
Side Windows Shade 5 side filters that increase peripheral vision
To be combined with 3M™ Adflo™ Powered Air Respirator
Designed to be compatible with 3M™ PELTOR™ Earmuffs X-Series

Typical properties

ADF Dark State Shades
None
ADF Shade Range
None
Brands
Speedglas™
Case Quantity
1
Features
Hard Top
Headgear Type
Grinding Visor, Hard Hats, Respiratory Assembly, Welding Helmet
Lens Type
No Lens
Product Color
Black
Product Series
9100, 9

3M™ Double Locking Rebar Snap Hook 2109193, Zinc Plated Steel, 3600 lb Gate, 2 1/2 in Throat

3M Product Number 2109193 3M ID 7100311021

Details

Corrosion resistant plated steel hardware
High strength construction with 3,600 lb (16kN) rated gate
Double action and locking gate for added safety
Compact design
Designed to allow horizontal movement along the anchorage, but does not include capability to pass intersecting structures
Compatible with various fall arrest systems
Recommended for use in multiple industries including construction, oil and gas, and utilities
Meets the requirements for 29 CFR OSHA 1910.140, 29 CFR OSHA 1926.502

Typical properties

Anchor Install Type
Reusable
Anchor Type
Pipe
Attachment Type
Hook, None
Brands
DBI-SALA®
Carabiner/Hook Material
Zinc Plated Steel
Case Quantity
1
Connected Safety ID Equipped
No
Dimensions
110.00x73.00xmm
Install Type
None, Removable
M

3M™ Protecta® Tripod Mounting Base Bracket - For Retrieval SRL 8008005, Silver

Part Number 8008005 3M Product Number 8008005 3M ID 7100232969

Details

Tripod mounting base bracket for mechanical device
Zinc plated steel construction
Mates with DBI-SALA® Support Structure Mounting Base Bracket
Simple bolt-on attachment to SRL
Compact design can be left in place indefinitely
Fast and simple detent style mounting base attachment

Typical properties

Brands
PROTECTA®
Case Quantity
1
Connected Safety ID Equipped
No
For Use With
Rebel™ Retrieval SRL
Net Weight (Imperial)
4.9 lb
Net Weight (Metric)
2.2 kg
Product Color
Silver
Product Type
Tripod Mounting Base Bracket - For Retrieval SRL
R

3M™ DBI-SALA® Nano-Lok™ Twin-Leg Connector 3100087

Part Number 3100087 3M Product Number 3100087 3M ID 7100157031

Details

Twin-leg connector attaches Nano-Lok™ directly to harness
High strength steel construction
Corrosion resistant zinc plated design
Extremely compact, lightweight design
Triple locking and self closing gate
Single-leg, twin-leg and fixed D-ring connectors available

Typical properties

Brands
DBI-SALA®
Case Quantity
1
Connected Safety ID Equipped
No
Dimensions
4.30x2.50x1.00in
Housing Type
None
Material
Steel/Nylon
Mounting Type
Direct to Harness Back
Product Series
Nano-Lok™
Product Type
Twin-Leg Connector
Recommended

3M™ DBI-SALA® Lad-Saf™ Bottom Bracket For Ladder Mast/Ladder Anchor Post 6116027, Galvanized Steel

Part Number 6116027 3M Product Number 6116027 3M ID 7100250927

Details

Bottom Bracket Grab Bar for 3M™ DBI-SALA® Lad-Saf™
Durable Steel construction
Various options of brackets for different bracket styles and sizes

Typical properties

Attachment Type
Bolt on Three Rungs, Bolt-On, Three Rungs
Brands
DBI-SALA®
Case Quantity
1
Connected Safety ID Equipped
No
Dimensions
5 in x 2.5 in x 41 in
For Use With
Ladder Mast/Posts
Install Type
Permanent
Maximum Number of Users
1-4 Us

3M™ DBI-SALA® Permanent Multi-Span Horizontal Lifeline Sleeve 7608002

Part Number 7608002 3M Product Number 7608002 3M ID 7100301368

Details

Heavy-duty, Melonite-treated steel construction

Lifeline sleeve glides smoothly as you work

Recommended for use in multiple industries including construction, facilities, power plants, general manufacturing, heavy infrastructure, and more

Single-span systems hold up to 2 workers

Engineered for standard connecting subsystems that limit fall-arrest forces to 900 lbs. (4 kN) or less

This safety equipment is designed for use with additional personal protective equipment (PPE)

This lifeline sleeve is permanently attached to the lifeline during installation

Typical properties

Brands

DBI-SALA®

Case Quantity

1

Connected Safety ID Equipped

No

Features

Permanent System Shuttle

For Use With

Sayflite™ Permanent Multi-span HLL

Install Type

Permanent

Lifeline Material

Order separately

Maximum Number of Workers

2

Net We

3M™ Universal Headgear For Hard Hat H24M 82520-10000, 20 ea/Case

3M Product Number 82520-10000 3M ID 7000002292 UPC 10078371825208

Details

Two position system locks shield up and out of place when not in use
Does not interfere with cap mounted earmuffs
Fits most cap-style hard hats
Quick change system with no snaps, bands or cams offers easy window replacement
System gives users a wide choice of faceshield materials, sizes, shapes, and tints for task specific requirements
Requires protective eyewear, sold separately
Meets the requirements of ANSI Z87.1-2003

Typical properties

Brands
3M™
Case Quantity
20
Compatible Hard Hat
H-700, H-700T
For Use With
Faceshield Attachment, Hard Hats, Hardhat Attachment, Ratchet Suspension, W Series Faceshields
Material
Aluminum
Product Color
Blue
Product Type
Headgear
Recommended

Dimensions and Classifications

Overall Height (Imperial)
9 in
Overall Height (Metric)
22.86 cm
Overall Length (Imperial)
9 in
Overall Length (Metric)
22.86 cm
Overall Width (Imperial)
1 in
Overall Width (Metric)
2.54 cm

3M™ U5B-ANSI Faceshield Holder for SecureFit™ Safety Helmet 10 EA/Case

3M Product Number U5B-ANSI 3M ID 7100179142 UPC 00076308943172

Details

Connects a variety of 3M™ faceshields to the 3M™ SecureFit™ Safety Helmet series

Features a unique system that allows faceshield replacement in seconds

Fits 3M™ SecureFit™ Safety Helmet X5000

3M™ Safety Helmet Adaptor for Visors sold Separately. Can also be used with 3M™ PELTOR™ X-Series Earmuffs

Typical properties

Brands

SecureFit™

Case Quantity

10

Compatible Hard Hat

X5000

For Use With

Hard Hats

Material

Nylon

Product Color

Black

Product Series

X5000

Product Type

Faceshield Holder

Recommended Application

Demolition, Forestry, Grinding, Remediation

3M™ Elevated Temperature Universal Faceshield Holder For Hard Hat H24T, Black, 10 EA/Case

3M Product Number H24T 3M ID 7100113761 UPC 50051131275107

Details

Two position system locks shield up and out of place when not in use
Quick change system with no snaps, bands or cams offers easy window replacement
System gives users a wide choice of faceshield materials, and tints for task specific requirements

Typical properties

Brands
3M™
Compatible Hard Hat
H-700, H-700T, H24T
For Use With
Hard Hats
High Heat
Yes
Material
Heat Resistant 15% Glass Nylon
Product Color
Black
Product Type
Faceshield Holder
Recommended Application
Casting, Furnace, Sampling, Tapping

3M™ Versaflo™ M-930 Visor Lock Kit 5 EA/Bag

3M Product Number M930 3M ID 7100198700 UPC 00051131279315

Details

Restricts lifting the visor frame of an M-400 series helmet, helping to prevent lifting of the visor when preferred/needed for use

Locks M-400 series faceshield in the closed position

For use with all M-400 series helmets, including the M-401, M-405, M-407, M-407SG and M-409SG

Typical properties

Brands

Versaflo™

Case Quantity

5/Case

Clip-on Welding Shield

No

Compatible With

3M™ Versaflo™ M-Series Helmet

Eye Protection

Yes

Includes

5 Visor Locks, 10 screws, Drill Guide

Material

Metal

Product Color

Silver

Product Series

M-Series

P

3M™ Speedglas™ G5-01 Inner Grinding Visor 46-0700-51, Anti-Fog and Hardcoated

3M Product Number 46-0700-51 3M ID 7100232450 UPC 00638060430644

Details

Grinding Visor comes with premium anti-fog and scratch resistant coatings
Regularly clean with a soft cloth and replace if any pits or scratches occur
For maximum safety and comfort, make it a habit to check your equipment regularly. Replace worn out or damaged parts
Replace worn out or damaged parts

Typical properties

Brands
Speedglas™
Compatible Welding Helmet
G5-01 Welding Helmets
Product Series
G5
Product Type
Visor
Recommended Application
Grinding, Metal Processing, Metal Repair, Welding
Recommended Industry
General Manufacturing, Heavy Infrastructure, I

3M™ Protecta® Modular Connector Shock Pack 1340151, Steel Swivel Snap Hook

3M Product Number 1340151 3M ID 7100318430 UPC 00648250246146

Details

Only compatible with 3M™ Protecta® Modular Edge Self-Retracting Lifelines Modular connectivity to ensure proper connection between 3M™ Protecta® Leading Edge Self-Retracting Lifeline (50ft) and the 24" modular shock pack Icons on the 3M™ Protecta® Edge Self-Retracting Lifeline housing and 3M™ Protecta® Modular Connector shock pack provide easy identification of compatible system components

Typical properties

Brands

PROTECTA®

Connected Safety ID Equipped

No

Install Type

Removable

Product Type

Modular D-ring Extension

Recommended Industry

Construction, General Industrial, General Manufacturing, Mining, Oil & Gas, Transportation, Utilities

Style

Singl

3M™ DBI-SALA® Nano-Lok™ Edge Twin-Leg Personal Self Retracting Lifeline 3500283, Cable, Aluminum Comfort Hook, 7 ft., Class 2 ANSI

3M Product Number 3500283 3M ID 7012819229 UPC 00648250243510

Details

Designed for foot-level tie-off and leading edge applications
Compact Design
Quick activating speed sensing brake system
Durable thermoplastic housing
Built-in connector for direct attachment to harness
High capacity external energy absorber and impact indicator
RFID equipped and compatible with inventory management system
Available in multiple styles and configurations

Typical properties

ANSI Class Level
Class 2
Average Arrest Force (Imperial)
900 lbf (ANSI), 900 lbf (OSHA 130 lb - 310 lb)
Average Arrest Force (Metric)
4 kN (ANSI), 4 kN (OSHA 130 lb - 310 lb)
Brands
DBI-SALA®
Case Quantity
1.0 per Case
Connected Safety ID Equipp

Dimensions and Classifications

Overall Length (Imperial)
7 ft
Overall Length (Metric)
2.13 m

3M™ DBI-SALA® Nano-Lok™ Edge Twin-Leg Personal Self Retracting Lifeline 3500282, Cable, Steel Swivel Snap Hook, 8 ft. Class 2 ANSI

3M Product Number 3500282 3M ID 7012819228 UPC 00648250243503

Details

- Designed for foot-level tie-off and leading edge applications
- Compact Design
- Quick activating speed sensing brake system
- Durable thermoplastic housing
- Built-in connector for direct attachment to harness
- High capacity external energy absorber and impact indicator
- RFID equipped and compatible with inventory management system
- Available in multiple styles and configurations

Typical properties

- ANSI Class Level
- Class 2
- Average Arrest Force (Imperial)
- 900 lbf (ANSI), 900 lbf (OSHA 130 lb - 310 lb)
- Average Arrest Force (Metric)
- 4 kN (ANSI), 4 kN (OSHA 130 lb - 310 lb)
- Brands
- DBI-SALA®
- Case Quantity
- 1.0 per Case
- Connected Safety ID Equipp

Dimensions and Classifications

- Overall Length (Imperial)
- 8 ft
- Overall Length (Metric)
- 2.44 m

3M™ DBI-SALA® Nano-Lok™ Edge Twin-Leg Personal Self-Retracting Lifeline 3500281, Cable, Steel Rebar Hook, 6 ft., Class 2, ANSI

3M Product Number 3500281 3M ID 7012819227 UPC 00648250243497

Details

- Designed for foot-level tie-off and leading edge applications
- Compact Design
- Quick activating speed sensing brake system
- Durable thermoplastic housing
- Built-in connector for direct attachment to harness
- High capacity external energy absorber and impact indicator
- RFID equipped and compatible with inventory management system
- Available in multiple styles and configurations

Typical properties

- ANSI Class Level
- Class 2
- Average Arrest Force (Imperial)
- 900 lbf (ANSI), 900 lbf (OSHA 130 lb - 310 lb)
- Average Arrest Force (Metric)
- 4 kN (ANSI), 4 kN (OSHA 130 lb - 310 lb)
- Brands
- DBI-SALA®
- Case Quantity
- 1.0 per Case
- Connected Safety ID Equipp

Dimensions and Classifications

- Overall Length (Imperial)
- 6 ft
- Overall Length (Metric)
- 1.8 m

3M™ DBI-SALA® Nano-Lok™ Edge Twin-Leg Personal Self Retracting Lifeline 3500280, Cable, Aluminum Rebar Hook, 8 ft., Class 2, ANSI

3M Product Number 3500280 3M ID 7012819226 UPC 00648250243480

Details

- Designed for foot-level tie-off and leading edge applications
- Compact Design
- Quick activating speed sensing brake system
- Durable thermoplastic housing
- Built-in connector for direct attachment to harness
- High capacity external energy absorber and impact indicator
- RFID equipped and compatible with inventory management system
- Available in multiple styles and configurations

Typical properties

- ANSI Class Level
- Class 2
- Average Arrest Force (Imperial)
- 900 lbf (ANSI), 900 lbf (OSHA 130 lb - 310 lb)
- Average Arrest Force (Metric)
- 4 kN (ANSI), 4 kN (OSHA 130 lb - 310 lb)
- Brands
- DBI-SALA®
- Case Quantity
- 1.0 per Case
- Connected Safety ID Equipp

Dimensions and Classifications

- Overall Length (Imperial)
- 8 ft
- Overall Length (Metric)
- 2.44 m

3M™ DBI-SALA® Nano-Lok™ edge Twin-Leg Personal Self-Retracting Lifeline 3500286, Galvanized Cable, 8 ft

3M Product Number 3500286 3M ID 7012819232 UPC 00648250243541

Details

- Designed for foot-level tie-off and leading edge applications
- Compact Design
- Quick activating speed sensing brake system
- Durable thermoplastic housing
- Built-in connector for direct attachment to harness
- High capacity external energy absorber and impact indicator
- RFID equipped and compatible with inventory management system
- Available in multiple styles and configurations

Typical properties

- ANSI Class Level
- Class 2
- Average Arrest Force (Imperial)
- 900 lbf (ANSI), 900 lbf (OSHA 130 lb - 310 lb)
- Average Arrest Force (Metric)
- 4 kN (ANSI), 4 kN (OSHA 130 lb - 310 lb)
- Brands
- DBI-SALA®
- Case Quantity
- 1.0 per Case
- Connected Safety ID Equipp

Dimensions and Classifications

- Overall Length (Imperial)
- 8 ft
- Overall Length (Metric)
- 2.4 m

3M™ DBI-SALA® Nano-Lok™ edge Twin-Leg Personal Self-Retracting Lifeline 3500285, Galvanized Cable, 8 ft

3M Product Number 3500285 3M ID 7012819231 UPC 00648250243534

Details

- Designed for foot-level tie-off and leading edge applications
- Compact Design
- Quick activating speed sensing brake system
- Durable thermoplastic housing
- Built-in connector for direct attachment to harness
- High capacity external energy absorber and impact indicator
- RFID equipped and compatible with inventory management system
- Available in multiple styles and configurations

Typical properties

- ANSI Class Level
- Class 2
- Average Arrest Force (Imperial)
- 900 lbf (ANSI), 900 lbf (OSHA 130 lb - 310 lb)
- Average Arrest Force (Metric)
- 4 kN (ANSI), 4 kN (OSHA 130 lb - 310 lb)
- Brands
- DBI-SALA®
- Case Quantity
- 1.0 per Case
- Connected Safety ID Equipp

Dimensions and Classifications

- Overall Length (Imperial)
- 8 ft
- Overall Length (Metric)
- 2.44 m

3M™ DBI-SALA® Nano-Lok™ edge Twin-Leg Personal Self-Retracting Lifeline 3500284, Galvanized Cable, 7 ft

3M Product Number 3500284 3M ID 7012819230 UPC 00648250243527

Details

- Designed for foot-level tie-off and leading edge applications
- Compact Design
- Quick activating speed sensing brake system
- Durable thermoplastic housing
- Built-in connector for direct attachment to harness
- High capacity external energy absorber and impact indicator
- RFID equipped and compatible with inventory management system
- Available in multiple styles and configurations

Typical properties

- ANSI Class Level
- Class 2
- Average Arrest Force (Imperial)
- 900 lbf (ANSI), 900 lbf (OSHA 130 lb - 310 lb)
- Average Arrest Force (Metric)
- 4 kN (ANSI), 4 kN (OSHA 130 lb - 310 lb)
- Brands
- DBI-SALA®
- Case Quantity
- 1.0 per Case
- Connected Safety ID Equipp

Dimensions and Classifications

- Overall Length (Imperial)
- 7 ft
- Overall Length (Metric)
- 2.13 m

3M™ Versaflo™ Peel-Off Visor Covers M-928/37452(AAD), for M-927 Premium Visor, 40 ea/Bag

3M ID 7100138631 UPC 50051131374527

Details

Helps protect from scratching or overspray of paint and chemicals
Up to 5 can be attached at once

Typical properties

Brands

Versaflo™

Case Quantity

40

Compatible With

3M™ M-Series Headgear, 3M™ Versaflo™ M-927 Premium Visor

Headgear Type

Headcover

High Heat

No

Product Series

M-Series

Product Type

Faceshield Cover

Recommended Application

Assembly & Mechani

3M™ DBI-SALA® Nano-Lok™ Edge Twin-Leg Personal Self Retracting Lifeline 3500278, Cable, Steel Rebar Hook, 7.3 ft., Class 2, ANSI

3M Product Number 3500278 3M ID 7012819224 UPC 00648250243466

Details

- Designed for foot-level tie-off and leading edge applications
- Compact Design
- Quick activating speed sensing brake system
- Durable thermoplastic housing
- Built-in connector for direct attachment to harness
- High capacity external energy absorber and impact indicator
- RFID equipped and compatible with inventory management system
- Available in multiple styles and configurations

Typical properties

- ANSI Class Level
- Class 2
- Average Arrest Force (Imperial)
- 900 lbf (ANSI), 900 lbf (OSHA 130 lb - 310 lb)
- Average Arrest Force (Metric)
- 4 kN (ANSI), 4 kN (OSHA 130 lb - 310 lb)
- Brands
- DBI-SALA®
- Case Quantity
- 1.0 per Case
- Connected Safety ID Equipp

Dimensions and Classifications

- Overall Length (Imperial)
- 7.3 ft
- Overall Length (Metric)
- 2.2 m

3M™ DBI-SALA® Nano-Lok™ Edge Twin-Leg Personal Self Retracting Lifeline 3500277 Cable, Aluminum Rebar Lock Hook 8 ft. Class 2 ANSI

3M Product Number 3500277 3M ID 7012819223 UPC 00648250243459

Details

- Designed for foot-level tie-off and leading edge applications
- Compact Design
- Quick activating speed sensing brake system
- Durable thermoplastic housing
- Built-in connector for direct attachment to harness
- High capacity external energy absorber and impact indicator
- RFID equipped and compatible with inventory management system
- Available in multiple styles and configurations

Typical properties

- ANSI Class Level
- Class 2
- Average Arrest Force (Imperial)
- 900 lbf (ANSI), 900 lbf (OSHA 130 lb - 310 lb)
- Average Arrest Force (Metric)
- 4 kN (ANSI), 4 kN (OSHA 130 lb - 310 lb)
- Brands
- DBI-SALA®
- Case Quantity
- 1.0 per Case
- Connected Safety ID Equipp

Dimensions and Classifications

- Overall Length (Imperial)
- 8 ft
- Overall Length (Metric)
- 2.44 m

3M™ DBI-SALA® Nano-Lok™ edge Twin-Leg Personal Self-Retracting Lifeline 3500276, Galvanized Cable, 8 ft

3M Product Number 3500276 3M ID 7012819222 UPC 00648250243442

Details

- Designed for foot-level tie-off and leading edge applications
- Compact Design
- Quick activating speed sensing brake system
- Durable thermoplastic housing
- Built-in connector for direct attachment to harness
- High capacity external energy absorber and impact indicator
- RFID equipped and compatible with inventory management system
- Available in multiple styles and configurations

Typical properties

- ANSI Class Level
- Class 2
- Average Arrest Force (Imperial)
- 900 lbf (ANSI), 900 lbf (OSHA 130 lb - 310 lb)
- Average Arrest Force (Metric)
- 4 kN (ANSI), 4 kN (OSHA 130 lb - 310 lb)
- Brands
- DBI-SALA®
- Case Quantity
- 1.0 per Case
- Connected Safety ID Equipp

Dimensions and Classifications

- Overall Length (Imperial)
- 8 ft
- Overall Length (Metric)
- 2.4 m

3M™ DBI-SALA® Nano-Lok™ edge Twin-Leg Tie-Back Personal Self-Retracting Lifeline 3500287, Galvanized Cable, 9 ft

3M Product Number 3500287 3M ID 7012828690 UPC 00648250243558

Details

- Designed for foot-level tie-off and leading edge applications
- Compact Design
- Quick activating speed sensing brake system
- Durable thermoplastic housing
- Built-in connector for direct attachment to harness
- High capacity external energy absorber and impact indicator
- RFID equipped and compatible with inventory management system
- Available in multiple styles and configurations

Typical properties

- ANSI Class Level
Class 2
- Brands
DBI-SALA®
- Connected Safety ID Equipped
Yes
- Harness Connection Hook Material
Zinc Plated Steel
- Harness Connection Type
Single Pin Connector
- Housing Material
Nylon Thermoplastic
- Housing Type
Thermoplastic
- Instal

Dimensions and Classifications

- Overall Length (Imperial)
9 ft
- Overall Length (Metric)
2.7 m

3M™ Versaflo™ Peel-Off Visor Covers M-926/37322(AAD), for M-925 Standard Visor, 40 EA/Case

Part Number 37322 3M Product Number M-926 3M ID 7000127689

Details

Up to five covers can be attached, one on top of the other

Typical properties

Brands
Versaflo™
Case Quantity
40
Compatible With
3M™ Versaflo™ M-Series Helmet
Headgear Type
Headcover
High Heat
No
Product Color
Transparent
Product Series
M-Series
Product Type
Headgear Cover
Recommended Application
Assembly & Mechanic

3M™ Versaflo™ Peel-Off Visor Cover S-920S, Small - Medium, for Integrated Suspension Products 40 EA/Case

3M Product Number S-920S 3M ID 7000127435 UPC 50051131171003

Details

For use with certain S-Series headcovers, small/medium only
Helps protect visor from contaminants and scratches

Typical properties

Brands

Versaflo™

Compatible With

3M™ S-Series Headgear

Headgear Type

Hood

Product Color

Transparent

Product Series

S-Series, Versaflo

Product Type

Faceshield Cover

Recommended Application

Assembly & Mechanical, Cleaning, Facility Maintenance,

3M™ DBI-SALA® Nano-Lok™ edge Personal Self-Retracting Lifeline 3500288, Galvanized Cable, 8 ft

3M Product Number 3500288 3M ID 7012828691 UPC 00648250243565

Details

- Designed for foot-level tie-off and leading edge applications
- Compact Design
- Quick activating speed sensing brake system
- Durable thermoplastic housing
- Built-in connector for direct attachment to harness
- High capacity external energy absorber and impact indicator
- RFID equipped and compatible with inventory management system
- Available in multiple styles and configurations

Typical properties

- ANSI Class Level
- Class 2
- Average Arrest Force (Imperial)
- 900 lbf (ANSI), 900 lbf (OSHA 130 lb - 310 lb)
- Average Arrest Force (Metric)
- 4 kN (ANSI), 4 kN (OSHA 130 lb - 310 lb)
- Brands
- DBI-SALA®
- Connected Safety ID Equipped
- Yes
- Harness Connection H

Dimensions and Classifications

- Overall Length (Imperial)
- 8 ft
- Overall Length (Metric)
- 2.4 m

3M™ DBI-SALA® Nano-Lok™ edge Personal Self-Retracting Lifeline 3500289, Galvanized Cable, 8 ft

3M Product Number 3500289 3M ID 7012819233 UPC 00648250243572

Details

Designed for foot-level tie-off and leading edge applications
Compact Design
Quick activating speed sensing brake system
Durable thermoplastic housing
Built-in connector for direct attachment to harness
High capacity external energy absorber and impact indicator
RFID equipped and compatible with inventory management system
Available in multiple styles and configurations

Typical properties

ANSI Class Level
Class 2
Average Arrest Force (Imperial)
900 lbf (ANSI), 900 lbf (OSHA 130 lb - 310 lb)
Average Arrest Force (Metric)
4 kN (ANSI), 4 kN (OSHA 130 lb - 310 lb)
Brands
DBI-SALA®
Connected Safety ID Equipped
Yes
Harness Connection H

Dimensions and Classifications

Overall Length (Imperial)
8 ft
Overall Length (Metric)
2.4 m

3M™ DBI-SALA® Nano-Lok™ edge Personal Self-Retracting Lifeline 3500290, Galvanized Cable, 8 ft

3M Product Number 3500290 3M ID 7012819234 UPC 00648250243589

Details

- Designed for foot-level tie-off and leading edge applications
- Compact Design
- Quick activating speed sensing brake system
- Durable thermoplastic housing
- Built-in connector for direct attachment to harness
- High capacity external energy absorber and impact indicator
- RFID equipped and compatible with inventory management system
- Available in multiple styles and configurations

Typical properties

- ANSI Class Level
- Class 2
- Average Arrest Force (Imperial)
- 900 lbf (ANSI), 900 lbf (OSHA 130 lb - 310 lb)
- Average Arrest Force (Metric)
- 4 kN (ANSI), 4 kN (OSHA 130 lb - 310 lb)
- Brands
- DBI-SALA®
- Connected Safety ID Equipped
- Yes
- Harness Connection H

Dimensions and Classifications

- Overall Length (Imperial)
- 8 ft
- Overall Length (Metric)
- 2.4 m

3M™ DBI-SALA® Nano-Lok™ edge Twin-Leg Tie-Back Personal Self-Retracting Lifeline 3500228, Galvanized Cable, 9 ft

Part Number 3500228 3M Product Number 3500228 3M ID 7012819190

Details

- Designed for foot-level tie-off and leading edge applications
- Compact Design
- Quick activating speed sensing brake system
- Durable thermoplastic housing
- Built-in connector for direct attachment to harness
- High capacity external energy absorber and impact indicator
- RFID equipped and compatible with inventory management system
- Available in multiple styles and configurations

Typical properties

- Anchor Connection Type
 - Tie-back Snap Hook
- Brands
 - DBI-SALA®
- Connected Safety ID Equipped
 - Yes
- Harness Connection Type
 - Built-in Connector
- Housing Material
 - Nylon Thermoplastic
- Lifeline Hook Material
 - Zinc Plated Steel
- Lifeline Length (Imperial)
 - 9

Dimensions and Classifications

- Overall Length (Imperial)
 - 9 ft

3M™ DBI-SALA® Nano-Lok™ edge Personal Self-Retracting Lifeline 3500294, Galvanized Cable, 8 ft

3M Product Number 3500294 3M ID 7012828695 UPC 00648250243626

Details

- Designed for foot-level tie-off and leading edge applications
- Compact Design
- Quick activating speed sensing brake system
- Durable thermoplastic housing
- Built-in connector for direct attachment to harness
- High capacity external energy absorber and impact indicator
- RFID equipped and compatible with inventory management system
- Available in multiple styles and configurations

Typical properties

- ANSI Class Level
- Class 2
- Average Arrest Force (Imperial)
- 900 lbf (ANSI), 900 lbf (OSHA 130 lb - 310 lb)
- Average Arrest Force (Metric)
- 4 kN (ANSI), 4 kN (OSHA 130 lb - 310 lb)
- Brands
- DBI-SALA®
- Connected Safety ID Equipped
- Yes
- Harness Connection H

Dimensions and Classifications

- Overall Length (Imperial)
- 8 ft
- Overall Length (Metric)
- 2.4 m

3M™ DBI-SALA® Nano-Lok™ edge Personal Self-Retracting Lifeline 3500295, Galvanized Cable, 8 ft

3M Product Number 3500295 3M ID 7012828696 UPC 00648250243633

Details

Designed for foot-level tie-off and leading edge applications
Compact Design
Quick activating speed sensing brake system
Durable thermoplastic housing
Built-in connector for direct attachment to harness
High capacity external energy absorber and impact indicator
RFID equipped and compatible with inventory management system
Available in multiple styles and configurations

Typical properties

ANSI Class Level
Class 2
Average Arrest Force (Imperial)
900 lbf (ANSI), 900 lbf (OSHA 130 lb - 310 lb)
Average Arrest Force (Metric)
4 kN (ANSI), 4 kN (OSHA 130 lb - 310 lb)
Brands
DBI-SALA®
Connected Safety ID Equipped
Yes
Harness Connection H

Dimensions and Classifications

Overall Length (Imperial)
8 ft
Overall Length (Metric)
2.4 m

3M™ DBI-SALA® Nano-Lok™ edge Personal Self-Retracting Lifeline 3500296, Galvanized Cable, 7 ft

3M Product Number 3500296 3M ID 7012819235 UPC 00648250243640

Details

- Designed for foot-level tie-off and leading edge applications
- Compact Design
- Quick activating speed sensing brake system
- Durable thermoplastic housing
- Built-in connector for direct attachment to harness
- High capacity external energy absorber and impact indicator
- RFID equipped and compatible with inventory management system
- Available in multiple styles and configurations

Typical properties

- ANSI Class Level
- Class 2
- Average Arrest Force (Imperial)
- 900 lbf (ANSI), 900 lbf (OSHA 130 lb - 310 lb)
- Average Arrest Force (Metric)
- 4 kN (ANSI), 4 kN (OSHA 130 lb - 310 lb)
- Brands
- DBI-SALA®
- Connected Safety ID Equipped
- Yes
- Harness Connection H

Dimensions and Classifications

- Overall Length (Imperial)
- 7 ft
- Overall Length (Metric)
- 2.1 m

3M™ DBI-SALA® Nano-Lok™ edge Tie-Back Personal Self-Retracting Lifeline 3500297, Galvanized Cable, 9 ft

3M Product Number 3500297 3M ID 7012828697 UPC 00648250243657

Details

- Designed for foot-level tie-off and leading edge applications
- Compact Design
- Quick activating speed sensing brake system
- Durable thermoplastic housing
- Built-in connector for direct attachment to harness
- High capacity external energy absorber and impact indicator
- RFID equipped and compatible with inventory management system
- Available in multiple styles and configurations

Typical properties

- ANSI Class Level
- Class 2
- Average Arrest Force (Imperial)
- 900 lbf (ANSI), 900 lbf (OSHA 130 lb - 310 lb)
- Average Arrest Force (Metric)
- 4 kN (ANSI), 4 kN (OSHA 130 lb - 310 lb)
- Brands
- DBI-SALA®
- Connected Safety ID Equipped
- Yes
- Harness Connection H

Dimensions and Classifications

- Overall Length (Imperial)
- 9 ft
- Overall Length (Metric)
- 2.7 m

3M™ DBI-SALA® Nano-Lok™ edge Personal Self-Retracting Lifeline 3500291, Galvanized Cable, 8 ft

3M Product Number 3500291 3M ID 7012828692 UPC 00648250243596

Details

Designed for foot-level tie-off and leading edge applications
Compact Design
Quick activating speed sensing brake system
Durable thermoplastic housing
Built-in connector for direct attachment to harness
High capacity external energy absorber and impact indicator
RFID equipped and compatible with inventory management system
Available in multiple styles and configurations

Typical properties

ANSI Class Level
Class 2
Average Arrest Force (Imperial)
900 lbf (ANSI), 900 lbf (OSHA 130 lb - 310 lb)
Average Arrest Force (Metric)
4 kN (ANSI), 4 kN (OSHA 130 lb - 310 lb)
Brands
DBI-SALA®
Connected Safety ID Equipped
Yes
Harness Connection H

Dimensions and Classifications

Overall Length (Imperial)
8 ft
Overall Length (Metric)
2.4 m

3M™ DBI-SALA® Nano-Lok™ edge Personal Self-Retracting Lifeline 3500292, Galvanized Cable, 7.3 ft

3M Product Number 3500292 3M ID 7012828693 UPC 00648250243602

Details

- Designed for foot-level tie-off and leading edge applications
- Compact Design
- Quick activating speed sensing brake system
- Durable thermoplastic housing
- Built-in connector for direct attachment to harness
- High capacity external energy absorber and impact indicator
- RFID equipped and compatible with inventory management system
- Available in multiple styles and configurations

Typical properties

- ANSI Class Level
- Class 2
- Average Arrest Force (Imperial)
- 900 lbf (ANSI), 900 lbf (OSHA 130 lb - 310 lb)
- Average Arrest Force (Metric)
- 4 kN (ANSI), 4 kN (OSHA 130 lb - 310 lb)
- Brands
- DBI-SALA®
- Connected Safety ID Equipped
- Yes
- Harness Connection H

Dimensions and Classifications

- Overall Length (Imperial)
- 7.3 ft
- Overall Length (Metric)
- 2.2 m

3M™ Faceshield Cover 6885/07142(AAD), 100 ea/Bag

3M ID 7100138628 UPC 50051131071426

Details

Accessory to protect lenses from scratches and dust
Designed for use with 3M Full Facepiece 6000 Series
Also known as “tear away” or “peel-off” lens cover
Recommended for use in painting applications
Protects investment in respiratory equipment

Typical properties

Brands

3M™

Recommended Application

Composite Finishing, Final Finish, Paint Preparation, Painting, Welding

eClass 14 Classification Group

40220191

3M™ Tinted Lens Cover 6886, Accessory 25 EA/Bag

Part Number 66187 3M Product Number 6886 3M ID 7000052088

Details

Use with 3M™ Full Facepieces 6000 Series (sold separately)
Shields eyes from bright light to make it easier to focus on outdoor work
Not for use in welding or other applications that require reduction of UV or IR radiation beyond the capability of normal nonprescription sunglasses
Cover fits easily over lens
Approved 3M protection accessory

Typical properties

Accessories
No
Boxes per Case
25
Brands
3M™
Case Quantity
25/Bag
Clip-on Welding Shield
No
Compatible Respirator
6000 Series
Eye Protection
Yes
Facepiece Type
Full Facepiece Reusable
Product Code
6886
Product Series
6000
Product Type

3M™ Lens Cover FF-400-15, 100 ea/Bag

Part Number 89486 3M Product Number FF-400-15 3M ID 7000029958

Details

Replacement part to use with 3M Ultimate FX Full Facepiece Reusable Respirators FF-401, FF-402, and FF-403 (sold separately)
Designed for use with the 3M Ultimate FX Full Facepiece Reusable Respirators (sold separately)
Protects the lens of the facepiece
Easy to fit over lens
Measures 12.7 inches overall width x 6.4 inches overall height

Typical properties

Accessories
Yes
Boxes per Case
100
Brands
3M™
Case Quantity
100/case
Clip-on Welding Shield
No
Compatible Respirator
FF-800 Series
Compatible with 3M™ PAPR Systems
No
Compatible with 3M™ Supplied Air System
Yes
Compatible with Welding Shie

3M™ Semi-Permanent Lens Protector FF-400-17, 20 EA/Case

Part Number 89487 3M Product Number FF-400-17 3M ID 7000029959

Details

Scotchgard™ coating to help protect 3M™ Ultimate FX Full Facepiece Reusable Respirator Series FF-400 lens

For temporary use

Adhesive seals firmly around the perimeter of the lens to form a barrier against debris

Disposable accessory designed for temporary use

Protects investment in respiratory equipment

Typical properties

Accessories

Yes

Boxes per Case

20

Brands

3M™

Case Quantity

20/case

Clip-on Welding Shield

No

Compatible Respirator

FF-800 Series

Compatible with 3M™ PAPR Systems

No

Compatible with 3M™ Supplied Air System

Yes

Compatible with Welding Shield

3M™ Lens Cover 7899-100/7899-100-AM, Accessory 100 EA/Case

Part Number 60418 3M Product Number 7899-100/7899-100-AM 3M ID 7100189715

Details

Disposable accessory to protect lenses from scratches, dust and overspray
Designed for use with 3M Full Facepiece 7000 Series
Recommended for painting and other spray applications
Replaceable cover easily fits over lens
Protects investment in respiratory equipment

Typical properties

Accessories

No

Boxes per Case

100

Brands

3M™

Case Quantity

100/case

Clip-on Welding Shield

No

Compatible with 3M™ PAPR Systems

No

Compatible with 3M™ Supplied Air System

Yes

Compatible with Welding Shield

No

Cool Flow™ Exhalation Valve

No

3M™ DBI-SALA® EZ-Stop™ Leading Edge Self-Retracting Lifeline with Modular Rubber Shock Cover 1246512

3M Product Number 1246512 3M ID 7012817306

Details

Featuring an bright orange external energy absorber on 17.5 inch D-ring extension with Zinc plated steel modular connection and snap hook, for leading edge applications

Extends dorsal harness D-Ring for easy user attachment

3M™ DBI-SALA® Smart Lock Modular shock pack can be purchased as a replacement or as additional extension for other users

Icons on the 3M™ DBI-SALA® Smart Lock Modular Edge Icons on the 3M™ Smart Lock Edge Self-Retracting Lifeline housing and 3M™ Smart Lock Modular Connector shock-pack provide easy identification of compatible system components SRL housing and 3M™ DBI-SALA® Smart Lock Modular Shock

Absorber extension provide easy identification of compatible system components

Only compatible with 3M™ DBI-SALA® Smart Lock Modular Edge Self Retracting Lifelines

Icons on the SRL housing and D-ring extension provide easy identification of compatible system components

Typical properties

Brands

DBI-SALA®

Connected Safety ID Equipped

Yes

Install Type

Temporary/Portable

Material

Nitrile Butadiene Rubber

Maximum Number of Users

One

Product Color

Orange

Product Type

Modular D-ring Extension

Recommended Application

Decking, Lead

Dimensions and Classifications

Overall Length (Imperial)

17.5 in

Overall Length (Metric)

44.45 cm

3M™ DBI-SALA® EZ-Stop™ Modular Shock Absorber Assembly For Leading Edge Self-Retracting Lifeline 1246500

Part Number 1246500 3M Product Number 1246500 3M ID 7100260189

Details

14" Leading Edge D-Ring Extension with modular connector end
Engineered to allow a 14" D-ring extension in leading edge applications
Extends dorsal harness D-Ring for easy user attachment
Icons on the 3M™ DBI-SALA® Smart Lock Modular Edge Icons on the 3M™ Smart Lock Edge Self-Retracting Lifeline housing and 3M™ Smart Lock Modular Connector shock-pack provide easy identification of compatible system components
SRL housing and 3M™ DBI-SALA® Smart Lock Modular Shock Absorber extension provide easy identification of compatible system components
Only compatible with 3M™ DBI-SALA® Smart Lock Modular Edge Self Retracting Lifelines
Icons on the SRL housing and D-ring extension provide easy identification of compatible system components

Typical properties

Brands

DBI-SALA®

Connected Safety ID Equipped

No

Dimensions

3" x 2.5" x 16"

For Use With

Full Body Harness. Use only with Smartlock LE Modular SRL models 3503848, 3503850, 3503851, 3503852

Install Type

Temporary

Net Weight (Imperial)

1.6 lb

Pr

Dimensions and Classifications

Overall Length (Imperial)

14 in

3M™ Belt Loop with D-ring 1500116, 5 lb Capacity, 10 ea/Pack

3M Product Number 1500116 3M ID 7100310178 UPC 00852684930131

Details

Compatible with 3M™ DBI-SALA® Fall Protection for Tools accessories
Provides workers an attachment point to secure tools and accessories while working at height
Multiple attachment point and capacity options designed for a variety of applications

Typical properties

Brands
DBI-SALA®
Case Quantity
10
Connected Safety ID Equipped
No
Dimensions
4.00 x 1.00 inch
Manufacturing Origin
Taiwan
Net Weight (Metric)
0.27 kg
Product Color
Yellow
Product Type
Belt Loop D-ring
Recommended Industry
Construction, Ge

Dimensions and Classifications

Overall Height (Metric)
34.29 mm
Overall Length (Metric)
299.72 mm

3M™ DBI-SALA® Adjustable Wristband with Cord 1500085, 10/Pack

3M Product Number 1500085 3M ID 7100230443 UPC 00852684933101

Details

Compatible with 3M™ DBI-SALA® Fall Protection for Tools accessories
Provides workers an attachment point to secure tools and accessories while working at height
Multiple attachment point and capacity options designed for a variety of applications

Typical properties

Brands
DBI-SALA®
Case Quantity
10
Connected Safety ID Equipped
No
Manufacturing Origin
Taiwan
Net Weight (Imperial)
1.5 lb
Net Weight (Metric)
0.7 kg
Product Color
Black
Product Type
Adjustable Wristband, Adjustable Wristband with Cord
Rec

Dimensions and Classifications

Overall Height (Metric)
57.15 mm
Overall Length (Metric)
281.94 mm

3M™ Belt Loop with Trigger 1500118, 5 lb Capacity, 10 ea/Pack

3M Product Number 1500118 3M ID 7100249204 UPC 00852684930186

Details

Compatible with 3M™ DBI-SALA® Fall Protection for Tools accessories
Provides workers an attachment point to secure tools and accessories while working at height
Multiple attachment point and capacity options designed for a variety of applications

Typical properties

Brands
DBI-SALA®
Case Quantity
10
Connected Safety ID Equipped
No
Dimensions
4.00 x 1.00 inch
Manufacturing Origin
Taiwan
Net Weight (Metric)
0.47 kg
Product Color
Yellow
Product Type
Belt Loop with Trigger Attachment
Recommended Industry

Dimensions and Classifications

Overall Height (Metric)
39.37 mm
Overall Length (Metric)
298.45 mm

3M™ Adjustable Hook and Loop Wristband with Cord 1500084, 5 lb Capacity, Universal

3M Product Number 1500084 3M ID 7012818122 UPC 00852684933088

Details

Compatible with 3M™ DBI-SALA® Fall Protection for Tools accessories
Provides workers an attachment point to secure tools and accessories while working at height
Multiple attachment point and capacity options designed for a variety of applications

Typical properties

Brands
DBI-SALA®
Case Quantity
1
Connected Safety ID Equipped
No
Net Weight (Imperial)
1.5 lb
Net Weight (Metric)
0.7 kg
Product Color
Black
Product Type
Adjustable Wristband with Cord
Recommended Industry
Construction, General Industrial,

3M™ DBI-SALA® Harness Adaptor 1500161, 1 EA/PACK

Part Number 1500161 3M Product Number 1500161 3M ID 7100214238

Details

Compatible with 3M™ DBI-SALA® Fall Protection for Tools accessories
Provides workers an attachment point to secure tools and accessories while working at height
Multiple attachment point and capacity options designed for a variety of applications

Typical properties

Brands
DBI-SALA®
Connected Safety ID Equipped
No
Dimensions
(2.62x1.50x0.25)in,(2.62 x 1.50 x 0.25)in
Net Weight (Imperial)
0.04 lb
Net Weight (Metric)
0.02 kg
Product Type
Harness Adapter
Recommended Industry
Construction, General Industrial

3M™ Belt Loop with D-ring 1500115, 5 lb Capacity

3M Product Number 1500115 3M ID 7012818151 UPC 00852684930117

Details

Compatible with 3M™ DBI-SALA® Fall Protection for Tools accessories
Provides workers an attachment point to secure tools and accessories while working at height
Multiple attachment point and capacity options designed for a variety of applications

Typical properties

Brands

DBI-SALA®

Case Quantity

1

Connected Safety ID Equipped

No

Dimensions

4.00 x 1.00 inch

Product Color

Yellow

Product Type

Belt Loop D-ring

Recommended Industry

Construction, General Industrial, Mining, Oil & Gas, Transportation, Utilitie

3M™ DBI-SALA® FlexiGuard™ M200 Adjustable Upright Fork Pocket Kit 8530912

3M Product Number 8530912 3M ID 7100314340 UPC 00648250185094

Details

Enables mast to be separated from the base and transported vertically using a forklift

Designed to enable system transport

Helps maximize usage in various locations

Typical properties

Brands

DBI-SALA®

Connected Safety ID Equipped

No

Install Type

Temporary/Portable

Manufacturing Origin

USA

Net Weight (Imperial)

70 lb

Net Weight (Metric)

32 kg

Product Series

M200

Product Type

Modular Jib Accessory

Recommended Industry

Tr

Dimensions and Classifications

Overall Height (Metric)

0 mm

Overall Length (Metric)

0 mm

Overall Width (Metric)

0 mm

3M™ PELTOR™ Replacement Battery PIC-100BA, 20 ea/Case

3M Product Number PIC-100BA 3M ID 7100262644 UPC 00638060433102

Details

Battery lasts up to 16 hours
For use with PIC-100 EU and PIC-100 NA headsets

Typical properties

Battery Life
Approx. 16 Hours
Battery Type
Rechargeable Li-ion Pack
Brands
PELTOR™
Case Quantity
20
Compatible With
PIC-100 Communication Headset
Product Type
Battery
eClass 14 Classification Group
40270191

3M™ DBI-SALA® Lad-Saf™ Cable Vertical Safety System Cable Guide Support 6100136, Stainless Steel

Part Number 6100136 3M Product Number 6100136 3M ID 7012819665

Details

Cable guide support for Lad-Saf™ steel pole and angle leg tower ladder safety system

Bolts to cable guide for fast, easy and safe installation (order separately)

User installed weld-on bracket is fast, easy and safe

Extremely rugged and corrosion resistant stainless steel construction

Complete system accommodates up to 4 workers at one time

Customizable to suit almost any application

Order top bracket, stand-offs, cable, cable guide, and sleeve separately

Typical properties

Attachment Type

Bolt-On, Weld-On

Brands

DBI-SALA®

Case Quantity

1,1 EA/Case

Connected Safety ID Equipped

No

Dimensions

2.2 in x 2.2 in x 2.2 in

For Use With

Steel Pole/Tower

Install Type

Permanent

Maximum Number of Users

1-4 Users

Net Weig

3M™ DBI-SALA® Concrete Detent Anchor 2101004, 1 EA

Part Number 2101004 3M Product Number 2101004 3M ID 7100188833

Details

Rugged and corrosion resistant material construction for durability with compact and lightweight design
Use vertically in wall or horizontally in ceiling (both components)
High strength steel construction
Compatible with various fall arrest systems
Meets the requirements for 29 CFR OSHA 1910.140, and OSHA 1926.502
Recommended for use in the construction, general industrial, mining, oil and gas, and utilities industries
This safety equipment is designed for use with additional personal fall protection systems (PPE)
Installs into 7/8 in. (22 mm) concrete hole with adhesive
Swiveling D-ring tie-off point
Socket cover cap included
Reusable detent D-ring assembly - extra sockets (#2101000) and detent D-rings (#2101002) also available

Typical properties

Anchor Install Type
Permanent
Attachment Type
Screw/Adhesive
Brands
DBI-SALA®
Case Quantity
1
Connected Safety ID Equipped
No
Install Type
Permanent
Material
Stainless Steel
Product Color
Silver
Product Type
Concrete Detent Anchor
Recomm

3M™ DBI-SALA® Temporary Pour/Fasten-In-Place Horizontal Lifeline Intermediate Bracket 7400200

Part Number 7400200 3M Product Number 7400200 3M ID 7012820239

Details

Zinc-plated steel materials are durable and stand up to harsh environments
Portable design is durable, yet lightweight, for easy transport
Compatible with multi-span lifeline configurations
Intended for use in a temporary horizontal lifeline system
Designed for use in Pour-in-Place Post Horizontal Lifeline Systems or fasten-in-place steel applications
This safety equipment is intended for use with additional personal protective equipment (PPE)
Single-span systems hold up to 2 workers; multi-span systems hold up to 6 workers
Recommended for use in multiple industries including construction, facilities, general manufacturing, heavy infrastructure, and more

Typical properties

Brands
DBI-SALA®
Case Quantity
1
Connected Safety ID Equipped
No
For Use With
3M™ DBI-SALA® SecuraSpan™ Pour-in-Place/Fasten-in-Place HLL system
Install Type
Temporary/Portable
Lifeline Material
Order separately
Maximum Number of Workers
2 Pe

3M™ DBI-SALA® Flexiguard™ A-Frame Rail Adjustable Height Anchor System

8517780, 2 User, Yellow, 16 - 22.5 ft Height, 20 ft Width

Part Number 8517780 3M Product Number 8517780 3M ID 7100231968

Details

Multiple height and width configurations available
Aluminum and steel construction
Extruded aluminum rail requires minimal maintenance and includes two trolleys
System includes steel leveling jacks
Conforms to the requirements of OSHA 1926.502 and OSHA 1910.66
Suitable for numerous applications within the transportation, construction, utilities, and mining industries

Typical properties

Brands
DBI-SALA®
Case Quantity
1
Connected Safety ID Equipped
Yes
Install Type
Temporary/Portable
Maximum Height (Imperial)
24.38 ft
Maximum Height (Metric)
7.43 m
Maximum Number of Users
Two
Product Color
Silver, Yellow
Product Series
FI

Dimensions and Classifications

Overall Width (Imperial)
24.06 ft
Overall Width (Metric)
7.33 m

3M™ DBI-SALA® Detent Anchor D-ring/Pin For Concrete 2101002

Part Number 2101002 3M Product Number 2101002 3M ID 7012818270

Details

Rugged and corrosion resistant material construction for durability with compact and lightweight design
Use vertically in wall or horizontally in ceiling (both components)
High strength steel construction
Compatible with various fall arrest systems
Meets the requirements for 29 CFR OSHA 1910.140, and OSHA 1926.502
Recommended for use in the construction, general industrial, mining, oil and gas, and utilities industries
This safety equipment is designed for use with additional personal fall protection systems (PPE)
Detent pin for use with 2101000 concrete socket
Swiveling D-ring tie-off point

Typical properties

Anchor Install Type
Permanent
Attachment Type
Screw/Adhesive
Brands
DBI-SALA®
Case Quantity
1
Connected Safety ID Equipped
No
Install Type
Reusable or Permanent
Material
Stainless Steel
Product Color
Silver
Product Type
Concrete Detent Pi

3M™ PELTOR™ Optime™ 101 Earmuffs H7A, Over-the-Head, 10 EA/Case

Part Number 8071 3M Product Number H7A 3M ID 7000009669

Details

Earmuffs recommended for TWA noise exposures up to 101 dBA
Stainless steel headband distributes weight for low pressure fit
Earcup pivot points tilt for comfort that adjusts to individual wearers
Noise Reduction Rating (NRR) 27 decibels
Earcups with liquid and foam filled cushions offer comfort for long wear and optimum seal

Typical properties

Attenuation Rating
27.0 Decibel
Bluetooth
No
Brands
PELTOR™
Case Quantity
10
Corded
No
Dielectric
No
Earmuff Style
Over the Head
Electrically Insulated
No
Hearing Protection Style
Over-the-Head
Material
ABS
Metal Detectable
No
Moistu

3M™ PELTOR™ Optime™ 101 Earmuffs H7P3E, Hard Hat Attached, 10 EA/Case

3M Product Number H7P3E 3M ID 7000009668 UPC 10093045080738

Details

Cap-mounted design allows for easy use with most hard hats

Color-coding for compliance sighting

Noise Reduction Rating (NRR)*: 24 dB. CSA Class A

*The NRR may overestimate the hearing protection provided during typical use

Typical properties

Attenuation Rating

24.0 Decibel

Bluetooth

No

Brands

PELTOR™

Case Quantity

10

Corded

No

Dielectric

No

Earmuff Style

Hard Hat Attached

Electrically Insulated

No

Hearing Protection Style

Hard Hat Attached

Hearing Protection Type

cap-mount

3M™ Infant Eartip 3.5mm 420-2094, 10 Pair EA/Case

3M Product Number 420-2094 3M ID 7100133269 UPC 10080529510102

Details

3M PSD products are for occupational use only

*The NRR may overestimate the hearing protection provided during typical use

Typical properties

Brands

3M™

Case Quantity

10

Hearing Protection Style

Probed for Fit Testing

Product Type

Infant Eartip

Shape

Cylinder

3M™ DBI-SALA® Sliding Rail Anchor 2199938, Stainless Steel, Fits 2-3/4 – 3-1/4 in Rails

Part Number 2199938 3M Product Number 2199938 3M ID 7100246255

Details

Compatible with various fall protection systems
Compact, lightweight design
Ideal for use with personal fall arrest systems with self-retracting lifelines
Recommended for use in the construction, general industrial, mining, oil and gas, transportation, utilities, and wind energy industries
Portable and reusable
Corrosion-resistant construction for durability
This safety equipment is designed for use with additional personal protective equipment (PPE)
Installs onto 2-3/4 in. to 3-1/4 in. wide rails - (90-141 lbs/yd and 132 lbs head-free rail)
Fall arrest- and restraint-rated for one worker
Features high-strength stainless steel construction

Typical properties

Anchor Install Type
Reusable
Attachment Type
Clamp
Brands
PROTECTA®
Carabiner/Hook Material
Zinc Plated Steel
Case Quantity
1
Connected Safety ID Equipped
No
Dimensions
(5.00x3.70x5.00)in
Install Type
Reusable
Material
Stainless Steel
Pr

3M™ Speedglas™ G5 Series Carry & Storage Bag, SG-95, 1 EA/Case

3M Product Number SG-95 3M ID 7100215530 UPC 00076308944780

Details

Contains removable straps so the bag can be used as either a carry bag or a back pack

To protect your welding respiratory system from scratches

Fits both helmet and powered respirator or supplied air regulator

For highest possible safety and comfort, regularly check your equipment for worn or damaged parts

Carry or store your equipment for best comfort or care

Typical properties

Brands

Speedglas™

Compatible Welding Helmet

G5-01 Welding Helmets

Product Color

Black

Product Series

G5

Product Type

Storage Bag

Recommended Application

Grinding, Metal Processing, Metal Repair, Welding

Recommended Industry

General Manufactur

3M™ Speedglas™ Carry Bag SG-90, Black, 1 EA/Case

3M Product Number SG-90 3M ID 7000128116 UPC 00051131498716

Details

Carry Bag

Accessory Part

Comfortably carry your powered air respiratory protection (PAPR) system with welding system backpacks

For highest possible safety and comfort, regularly check your equipment for worn or damaged parts

Carry or store your equipment for best comfort or care

Typical properties

Brands

Speedglas™

Case Quantity

1

Features

Respiratory Accessory

For Use With

3M™ Speedglas™ 9100MP Welding Helmets

Product Color

Black

Product Series

9100, 9100 FX, 9100 FX-Air, 9100 MP, 9100-Air

Product Type

Carrying Bag

Recommended Applic

3M™ Speedglas™ Welding Helmet Bag SG-96, G5-02

Part Number SG-96 3M Product Number SG-96 3M ID 7100239736

Details

Replacement protective bag in black textile for the 3M™ Speedglas™ Welding Helmet G5-02

Included when you order a complete welding helmet G5-02

Ideally use the bag to store your welding helmet in a dry, clean area away from direct sunlight, high temperatures and solvents

For highest possible safety and comfort, regularly check your equipment for worn or damaged parts

Carry or store your equipment for best comfort or care

Typical properties

Brands

Speedglas™

Case Quantity

1/Case

Compatible Welding Helmet

G5-02 Welding Helmets

For Use With

G5-02 Welding Helmets

Product Series

G5

Product Type

Carrying Bag

Recommended Application

Welding

Recommended Industry

Construction, General

3M™ Speedglas™ 9100 FX/9100 FX-Air Welding Helmet SideWindow Covers 06-0700-73, Black, 2 EA/Case

3M Product Number 06-0700-73 3M ID 7000128086 UPC 00051131496811

Details

Back Cover Plate
Replacement Part

Typical properties

Brands
Speedglas™
Case Quantity
2
Compatible Welding Helmet
9100 FX Welding Helmets, 9100 FX-Air Welding Helmets
Features
9100 Series Accessory
For Use With
3M™ Speedglas™ 9100MP Welding Helmets
Graphic Theme
Black
Product Color
Black
Produc

3M™ DBI-SALA® U Maxi Clamp 4-Pack 7241208, 4 ea/Pack

Part Number 7241208 3M Product Number 7241208 3M ID 7100314937

Details

Durable materials and hardware designed to help stand up to harsh working conditions
Compatible with various fall arrest systems, not compliant for use with Horizontal Lifelines
Suitable for use in general industrial and construction industries
Compact, lightweight design
Meets the requirements for 29 CFR OSHA 1910.140 and 29 CFR OSHA 1926.502
Features corrosion-resistant, steel and aluminum construction for durability
This safety equipment is designed for use with additional personal protective equipment (PPE)
Z, U, and E Maxi Clamp 4-Pack Kits
For use with standing seam roof top anchor
Fits bulb, single folded, or double folded seams

Typical properties

Anchor Install Type
Permanent
Anchor Type
Roofing
Brands
DBI-SALA®
Case Quantity
1,1 EA/Case
Connected Safety ID Equipped
No
Dimensions
(2.00x1.50x2.00)in
For Use With
Standing Seam Roof Top Anchor
Install Type
Reusable
Material
Aluminum

3M™ Protecta® Reusable Swiveling Roof Anchor For Wood/Metal 2190070, with Fastener Kit

Part Number 2190070 3M Product Number 2190070 3M ID 7100237099

Details

Durable materials and hardware designed to help stand up to harsh working conditions
Compatible with various fall arrest systems, not compliant for use with Horizontal Lifelines
Suitable for use in general industrial and construction industries
Compact, lightweight design
Meets the requirements for 29 CFR OSHA 1910.140 and 29 CFR OSHA 1926.502
Features corrosion-resistant, steel and aluminum construction for durability
This safety equipment is designed for use with additional personal protective equipment (PPE)
Anchor can be installed to a variety of roofing materials to provide a tie-off point. Installs to sloped or flat wood and metal decking roofs
Fast and easy installation. Fastener kit includes 16 ea. ¼-14 x 2-1/2 in. self-tapping screws for steel installation and 8 ea. ¼ x 2-1/2 in. lag screws for wood
Portable and reusable. Anchor can be removed and simply reinstalled in a new location for added jobsite flexibility
360-degree swiveling maximizes your mobility. Low profile design stays out of the way as you work

Typical properties

Anchor Hook Material
Metal
Anchor Install Type
Reusable
Brands
PROTECTA®
Case Quantity
1 EA
Connected Safety ID Equipped
No
For Use With
3M™ Protecta® Self-Retracting Lifeline (SRLs)
Housing Material
Steel Only
Housing Type
Stainless Steel

Dimensions and Classifications

Overall Length (Imperial)
16.5 in

3M™ DBI-SALA® Detent Anchor Pour-in-Place Socket For Concrete 2100152

Part Number 2100152 3M Product Number 2100152 3M ID 7100246180

Details

Installs into 5,000 psi (34.5 MPa) minimum compressive strength concrete
Use vertically in wall or horizontally in ceiling
Order reusable detent D-ring assembly separately - model 2101002
Compact and lightweight design
Compact and lightweight design
High strength stainless steel construction
Rugged and corrosion resistant material

Typical properties

Anchor Install Type
Permanent
Attachment Type
Pour in Place
Brands
DBI-SALA®
Case Quantity
1
Connected Safety ID Equipped
No
Install Type
Permanent
Material
Stainless Steel
Product Color
Silver
Product Type
Concrete Pour in Place Detent S

3M™ Health, Safety and Compliance Software Training, 1 Hour

3M Product Number SIM-TRN-WEB 3M ID 6100001903

Details

Online training with a 3M specialist to expedite setup and system adoption
We'll work with you to quickly setup your account, help you define checklists, and help you to begin to tag assets and conduct inspections
Learn best practices and help ensure proper implementation
Select training times convenient to your schedule, with training increments as low as one hour

Typical properties

Brands
3M™
Product Type
Services
Recommended Application
Connected Safety
Recommended Industry
Construction, Food & Beverage
Training Duration
1 hr
Training Type
Online Training
eClass 14 Classification Group
25250000

3M™ DBI-SALA® Trigger X Adjustable Single Mode Rope Positioning Lanyard 1234090, 1/2 in Aramid Kernmantle, 6 ft

Part Number 1234090 3M Product Number 1234090 3M ID 7012817100

Details

ANSI & ASTM rated for Single Mode or Double Mode use
Available in Tie-back models to help reduce equipment needed in certain applications
Available in Tie-back models to help reduce equipment needed in certain applications

Typical properties

Anchor Connection Type
Rebar Hook
Anchor Hook Material
Aluminum
Brands
DBI-SALA®
Carabiner/Hook Material
Aluminum
Case Quantity
1
Connected Safety ID Equipped
Yes
Dimensions
6 ft. (1.8m)
Harness Connection Type
Carabiner
Install Type
Remo

3M™ DBI-SALA® Trigger X Tie-Back Adjustable Single Mode Rope Positioning Lanyard 1234092, 1/2 in Aramid Kernmantle, 6 ft

Part Number 1234092 3M Product Number 1234092 3M ID 7012817102

Details

ANSI & ASTM rated for Single Mode or Double Mode use
Available in Tie-back models to help reduce equipment needed in certain applications
Available in Tie-back models to help reduce equipment needed in certain applications

Typical properties

Anchor Connection Type
Rebar Hook
Anchor Hook Material
Alloy Steel
Brands
DBI-SALA®
Carabiner/Hook Material
Alloy Steel
Case Quantity
1
Connected Safety ID Equipped
Yes
Dimensions
6 ft. (1.8m)
Harness Connection Type
None
Install Type
Rem

3M™ DBI-SALA® Trigger X Tie-Back Adjustable Single/Double Mode Rope Positioning Lanyard 1234091, 1/2 in Aramid Kernmantle, 6 ft

Part Number 1234091 3M Product Number 1234091 3M ID 7012817101

Details

ANSI & ASTM rated for Single Mode or Double Mode use
Available in Tie-back models to help reduce equipment needed in certain applications
Available in Tie-back models to help reduce equipment needed in certain applications

Typical properties

Anchor Connection Type
Snap Hook
Anchor Hook Material
Aluminum
Brands
DBI-SALA®
Case Quantity
1
Connected Safety ID Equipped
Yes
Dimensions
6 ft. (1.8m)
Harness Connection Type
Carabiner
Install Type
Removable
Lanyard Length (Imperial)
6

3M™ DBI-SALA® Trigger X Tie-Back Adjustable Single/Double Mode Rope Positioning Lanyard 1234089, 1/2 in Aramid Kernmantle, 10 ft

Part Number 1234089 3M Product Number 1234089 3M ID 7012817099

Details

ANSI & ASTM rated for Single Mode or Double Mode use
Available in Tie-back models to help reduce equipment needed in certain applications
Available in Tie-back models to help reduce equipment needed in certain applications

Typical properties

Anchor Connection Type
Snap Hook
Anchor Hook Material
Aluminum
Brands
DBI-SALA®
Case Quantity
1
Connected Safety ID Equipped
Yes
Dimensions
10 ft. (3m)
Harness Connection Type
Carabiner
Install Type
Removable
Lanyard Length (Imperial)
10

3M™ DBI-SALA® Rescue/Retrieval Web Y-Lanyard with Spreader Bar 1231462, 4 ft

Part Number 1231462 3M Product Number 1231462 3M ID 7012691244

Details

DBI-SALA equipment is designed for use with DBI-SALA approved components and subsystems only

This equipment is for use by persons with a combined weight (person, clothing, tools, etc.) of no more than 310 lbs. (140.6 kg.)

This equipment must be used by persons who have been properly trained in its correct application and use

Typical properties

Anchor Hook Material

Zinc Plated Steel

Brands

DBI-SALA®

Case Quantity

1

Connected Safety ID Equipped

Yes

Harness Connection Hook Material

Zinc Plated Steel

Harness Connection Type

Snap Hook

Lanyard Length (Imperial)

4 ft

Lanyard Length (Metr

Dimensions and Classifications

Overall Length (Imperial)

4 ft

3M™ DBI-SALA® Rescue/Retrieval Y-Lanyard with Spreader Bar 1231460, 1 EA

Part Number 1231460 3M Product Number 1231460 3M ID 7100188784

Details

DBI-SALA equipment is designed for use with DBI-SALA approved components and subsystems only

This equipment is for use by persons with a combined weight (person, clothing, tools, etc.) of no more than 310 lbs. (140.6 kg.)

This equipment must be used by persons who have been properly trained in its correct application and use

Typical properties

Anchor Hook Material

Zinc Plated Steel

Brands

DBI-SALA®

Case Quantity

1

Connected Safety ID Equipped

Yes

Harness Connection Hook Material

Zinc Plated Steel

Harness Connection Type

Snap Hook

Lanyard Length (Imperial)

2 ft

Lanyard Length (Metr

Dimensions and Classifications

Overall Length (Imperial)

2 ft

3M™ DBI-SALA® Sealed-Blok™ Self Retracting Lifeline 3400135, Stainless Steel Cable, Swivel Snap Hook, 50 ft., Class 1, ANSI

3M Product Number 3400135 3M ID 7100318431 UPC 00648250244043

Details

- Available in multiple configurations, lifeline lengths, and material types
- Critical SRL components sealed from environmental exposure
- Swiveling self-locking snap hook with impact indicator
- Pivoting anchorage connector loop
- Durable Construction
- Galvanized & stainless steel cable options
- Quick activating speed-sensing locking system
- Equipped with an integrated carrying handle to assist in transporting the SRL to job sites
- IP 69K ingress protection rating
- Integrated fall arrest energy dissipation system
- Emergency retrieval system available on some models
- RFID tag is embedded in polyurethane bumper
- Ergonomic cable handle equipped with 3M™ Connected Safety ID (CSID)

Typical properties

- ANSI Class Level
- Class 1
- Anchor Connection Type
- Carabiner
- Anchor Hook Material
- Stainless Steel
- Anchor Hook Material
- Stainless Steel
- Average Arrest Force (Imperial)
- 900 lbf (ANSI), 900 lbf (OSHA 130 lb - 310 lb)
- Average Arrest Force (Metric)
- 4 k

Dimensions and Classifications

- Overall Length (Imperial)
- 50 ft
- Overall Length (Metric)
- 15.24 m

3M™ DBI-SALA® Sealed-Blok™ 3-Way Retrieval Self-Retracting Lifeline 3400149, Stainless Steel Cable, Snap Hook, 50 ft, Class 1

3M Product Number 3400149 3M ID 7100318432 UPC 00648250244180

Details

- Available in multiple configurations, lifeline lengths, and material types
- Critical SRL components sealed from environmental exposure
- Swiveling self-locking snap hook with impact indicator
- Pivoting anchorage connector loop
- Durable Construction
- Galvanized & stainless steel cable options
- Quick activating speed-sensing locking system
- Equipped with an integrated carrying handle to assist in transporting the SRL to job sites
- IP 69K ingress protection rating
- Integrated fall arrest energy dissipation system
- Emergency retrieval system available on some models
- RFID tag is embedded in polyurethane bumper
- Ergonomic cable handle equipped with 3M™ Connected Safety ID (CSID)

Typical properties

- ANSI Class Level
- Class 1
- Anchor Connection Type
- Carabiner
- Anchor Hook Material
- Stainless Steel
- Anchor Hook Material
- Stainless Steel
- Average Arrest Force (Imperial)
- 900 lbf (ANSI), 900 lbf (OSHA 130 lb - 310 lb)
- Average Arrest Force (Metric)
- 4 k

Dimensions and Classifications

- Overall Length (Imperial)
- 50 ft
- Overall Length (Metric)
- 15.24 m

3M™ DBI-SALA® Sealed-Blok™ Self-Retracting Lifeline 3400173, Stainless Steel Cable, 175 ft

3M Product Number 3400173 3M ID 7012828688 UPC 00648250253410

Details

- Available in multiple configurations, lifeline lengths, and material types
- Critical SRL components sealed from environmental exposure
- Swiveling self-locking snap hook with impact indicator
- Pivoting anchorage connector loop
- Durable Construction
- Galvanized & stainless steel cable options
- Quick activating speed-sensing locking system
- Equipped with an integrated carrying handle to assist in transporting the SRL to job sites
- IP 69K ingress protection rating
- Integrated fall arrest energy dissipation system
- Emergency retrieval system available on some models
- RFID tag is embedded in polyurethane bumper
- Ergonomic cable handle equipped with 3M™ Connected Safety ID (CSID)

Typical properties

- Anchor Connection Type
- Swivel Snap Hook
- Anchor Hook Material
- Stainless Steel
- Anchor Hook Material
- Stainless Steel
- Attachment Type
- None
- Average Arrest Force (Imperial)
- 1125 lbf (OSHA 130 lb - 310 lb), 1125 lbf (OSHA up to 420 lb)
- Average Arrest F

3M™ DBI-SALA® Sealed-Blok™ 3-Way Retrieval Self-Retracting Lifeline with Bracket 3400923, Galvanized Cable, 50 ft

Part Number 3400923 3M Product Number 3400923 3M ID 7100281221

Details

- Available in multiple configurations, lifeline lengths, and material types
- Critical SRL components sealed from environmental exposure
- Swiveling self-locking snap hook with impact indicator
- Pivoting anchorage connector loop
- Durable Construction
- Galvanized & stainless steel cable options
- Quick activating speed-sensing locking system
- Equipped with an integrated carrying handle to assist in transporting the SRL to job sites
- IP 69K ingress protection rating
- Integrated fall arrest energy dissipation system
- Emergency retrieval system available on some models
- RFID tag is embedded in polyurethane bumper
- Ergonomic cable handle equipped with 3M™ Connected Safety ID (CSID)

Typical properties

- Anchor Connection Type
 - Swivel Snap Hook
- Anchor Hook Material
 - Zinc Plated Steel
- Brands
 - DBI-SALA®
- Connected Safety ID Equipped
 - Yes
- Harness Connection Type
 - Carabiner
- Housing Material
 - Aluminum & Stainless Steel
- Lifeline Hook Material
 - Zinc Plated

Dimensions and Classifications

- Overall Length (Imperial)
 - 50 ft

3M™ DBI-SALA® Sealed-Blok™ Self-Retracting Lifeline 3400133, Stainless Steel Cable, 30 ft. (9 m)

3M Product Number 3400133 3M ID 7100306999 UPC 00648250244029

Details

- Available in multiple configurations, lifeline lengths, and material types
- Critical SRL components sealed from environmental exposure
- Swiveling self-locking snap hook with impact indicator
- Pivoting anchorage connector loop
- Durable Construction
- Galvanized & stainless steel cable options
- Quick activating speed-sensing locking system
- Equipped with an integrated carrying handle to assist in transporting the SRL to job sites
- IP 69K ingress protection rating
- Integrated fall arrest energy dissipation system
- Emergency retrieval system available on some models
- RFID tag is embedded in polyurethane bumper
- Ergonomic cable handle equipped with 3M™ Connected Safety ID (CSID)

Typical properties

- ANSI Class Level
- Class 1
- Anchor Connection Type
- Swivel Snap Hook
- Anchor Hook Material
- Zinc Plated Steel
- Anchor Hook Material
- Stainless Steel
- Average Arrest Force (Imperial)
- 900 lbf (ANSI), 900 lbf (OSHA 130 lb - 310 lb)
- Average Arrest Force (Met

Dimensions and Classifications

- Overall Length (Imperial)
- 30 ft
- Overall Length (Metric)
- 9 m

3M™ DBI-SALA® Sealed-Blok™ Self-Retracting Lifeline 3400144, Retrieval, Stainless Steel Cable, 30 ft. (9 m)

3M Product Number 3400144 3M ID 7100307002 UPC 00648250244135

Details

- Available in multiple configurations, lifeline lengths, and material types
- Critical SRL components sealed from environmental exposure
- Swiveling self-locking snap hook with impact indicator
- Pivoting anchorage connector loop
- Durable Construction
- Galvanized & stainless steel cable options
- Quick activating speed-sensing locking system
- Equipped with an integrated carrying handle to assist in transporting the SRL to job sites
- IP 69K ingress protection rating
- Integrated fall arrest energy dissipation system
- Emergency retrieval system available on some models
- RFID tag is embedded in polyurethane bumper
- Ergonomic cable handle equipped with 3M™ Connected Safety ID (CSID)

Typical properties

- ANSI Class Level
- Class 1
- Anchor Connection Type
- Swivel Snap Hook
- Anchor Hook Material
- Zinc Plated Steel
- Anchor Hook Material
- Stainless Steel
- Average Arrest Force (Imperial)
- 900 lbf (ANSI), 900 lbf (OSHA 130 lb - 310 lb)
- Average Arrest Force (Met

Dimensions and Classifications

- Overall Length (Imperial)
- 30 ft
- Overall Length (Metric)
- 9 m

3M™ DBI-SALA® Sealed-Blok™ Self-Retracting Lifeline 3400145, Retrieval with Bracket, Stainless Steel Cable, 30 ft. (9 m)

3M Product Number 3400145 3M ID 7100307003 UPC 00648250244142

Details

- Available in multiple configurations, lifeline lengths, and material types
- Critical SRL components sealed from environmental exposure
- Swiveling self-locking snap hook with impact indicator
- Pivoting anchorage connector loop
- Durable Construction
- Galvanized & stainless steel cable options
- Quick activating speed-sensing locking system
- Equipped with an integrated carrying handle to assist in transporting the SRL to job sites
- IP 69K ingress protection rating
- Integrated fall arrest energy dissipation system
- Emergency retrieval system available on some models
- RFID tag is embedded in polyurethane bumper
- Ergonomic cable handle equipped with 3M™ Connected Safety ID (CSID)

Typical properties

- ANSI Class Level
- Class 1
- Anchor Connection Type
- Swivel Snap Hook
- Anchor Hook Material
- Zinc Plated Steel
- Anchor Hook Material
- Stainless Steel
- Average Arrest Force (Imperial)
- 900 lbf (ANSI), 900 lbf (OSHA 130 lb - 310 lb)
- Average Arrest Force (Met

Dimensions and Classifications

- Overall Length (Imperial)
- 30 ft
- Overall Length (Metric)
- 9 m

3M™ DBI-SALA® Sealed-Blok™ 3-Way Retrieval Self-Retracting Lifeline with Bracket 3400151, Rope, 55 ft

3M Product Number 3400151 3M ID 7012828681

Details

- Available in multiple configurations, lifeline lengths, and material types
- Critical SRL components sealed from environmental exposure
- Swiveling self-locking snap hook with impact indicator
- Pivoting anchorage connector loop
- Durable Construction
- Galvanized & stainless steel cable options
- Quick activating speed-sensing locking system
- Equipped with an integrated carrying handle to assist in transporting the SRL to job sites
- IP 69K ingress protection rating
- Integrated fall arrest energy dissipation system
- Emergency retrieval system available on some models
- RFID tag is embedded in polyurethane bumper
- Ergonomic cable handle equipped with 3M™ Connected Safety ID (CSID)

Typical properties

- ANSI Class Level
- Class 1
- Anchor Connection Type
- Carabiner
- Anchor Hook Material
- Stainless Steel
- Average Arrest Force (Imperial)
- 1125 lbf (ANSI 130 lb - 310 lb), 900 lbf (OSHA 130 lb - 310 lb)
- Average Arrest Force (Metric)
- 4 kN (OSHA 130 lb - 310 l

3M™ DBI-SALA® Sealed-Blok™ 3-Way Retrieval Self-Retracting Lifeline with Bracket 3400171, Stainless Steel Cable, 130 ft. OSHA

3M Product Number 3400171 3M ID 7100324056 UPC 00648250253397

Details

- Available in multiple configurations, lifeline lengths, and material types
- Critical SRL components sealed from environmental exposure
- Swiveling self-locking snap hook with impact indicator
- Pivoting anchorage connector loop
- Durable Construction
- Galvanized & stainless steel cable options
- Quick activating speed-sensing locking system
- Equipped with an integrated carrying handle to assist in transporting the SRL to job sites
- IP 69K ingress protection rating
- Integrated fall arrest energy dissipation system
- Emergency retrieval system available on some models
- RFID tag is embedded in polyurethane bumper
- Ergonomic cable handle equipped with 3M™ Connected Safety ID (CSID)

Typical properties

- Anchor Connection Type
- Swivel Snap Hook
- Anchor Hook Material
- Stainless Steel
- Anchor Hook Material
- Stainless Steel
- Attachment Type
- None
- Average Arrest Force (Imperial)
- 1125 lbf (OSHA 130 lb - 310 lb), 1125 lbf (OSHA up to 420 lb)
- Average Arrest F

3M™ DBI-SALA® Sealed-Blok™ Self-Retracting Lifeline 3400172, Stainless Steel Cable, 130 ft

3M Product Number 3400172 3M ID 7012828687 UPC 00648250253403

Details

- Available in multiple configurations, lifeline lengths, and material types
- Critical SRL components sealed from environmental exposure
- Swiveling self-locking snap hook with impact indicator
- Pivoting anchorage connector loop
- Durable Construction
- Galvanized & stainless steel cable options
- Quick activating speed-sensing locking system
- Equipped with an integrated carrying handle to assist in transporting the SRL to job sites
- IP 69K ingress protection rating
- Integrated fall arrest energy dissipation system
- Emergency retrieval system available on some models
- RFID tag is embedded in polyurethane bumper
- Ergonomic cable handle equipped with 3M™ Connected Safety ID (CSID)

Typical properties

- Anchor Connection Type
- Swivel Snap Hook
- Anchor Hook Material
- Stainless Steel
- Anchor Hook Material
- Stainless Steel
- Attachment Type
- None
- Average Arrest Force (Imperial)
- 1125 lbf (OSHA 130 lb - 310 lb), 1125 lbf (OSHA up to 420 lb)
- Average Arrest F

3M™ DBI-SALA® Sealed-Blok™ 3-Way Retrieval Self-Retracting Lifeline 3400170, Stainless Steel Cable, 130 ft

3M Product Number 3400170 3M ID 7100323508 UPC 00648250253380

Details

- Available in multiple configurations, lifeline lengths, and material types
- Critical SRL components sealed from environmental exposure
- Swiveling self-locking snap hook with impact indicator
- Pivoting anchorage connector loop
- Durable Construction
- Galvanized & stainless steel cable options
- Quick activating speed-sensing locking system
- Equipped with an integrated carrying handle to assist in transporting the SRL to job sites
- IP 69K ingress protection rating
- Integrated fall arrest energy dissipation system
- Emergency retrieval system available on some models
- RFID tag is embedded in polyurethane bumper
- Ergonomic cable handle equipped with 3M™ Connected Safety ID (CSID)

Typical properties

- Anchor Connection Type
- Swivel Snap Hook
- Anchor Hook Material
- Stainless Steel
- Anchor Hook Material
- Stainless Steel
- Attachment Type
- None
- Average Arrest Force (Imperial)
- 1125 lbf (OSHA 130 lb - 310 lb), 1125 lbf (OSHA up to 420 lb)
- Average Arrest F

3M™ DBI-SALA® Sealed-Blok™ Self-Retracting Lifeline 3400169, Stainless Steel Cable, 85 ft

3M Product Number 3400169 3M ID 7012828686 UPC 00648250253373

Details

- Available in multiple configurations, lifeline lengths, and material types
- Critical SRL components sealed from environmental exposure
- Swiveling self-locking snap hook with impact indicator
- Pivoting anchorage connector loop
- Durable Construction
- Galvanized & stainless steel cable options
- Quick activating speed-sensing locking system
- Equipped with an integrated carrying handle to assist in transporting the SRL to job sites
- IP 69K ingress protection rating
- Integrated fall arrest energy dissipation system
- Emergency retrieval system available on some models
- RFID tag is embedded in polyurethane bumper
- Ergonomic cable handle equipped with 3M™ Connected Safety ID (CSID)

Typical properties

- Anchor Connection Type
- Swivel Snap Hook
- Anchor Hook Material
- Stainless Steel
- Anchor Hook Material
- Stainless Steel
- Attachment Type
- None
- Average Arrest Force (Imperial)
- 900 lbf (OSHA 130 lb - 310 lb), 900 lbf (OSHA up to 420 lb)
- Average Arrest For

3M™ DBI-SALA® Single-Span Horizontal Lifeline For Stanchions 7403030, Galvanized Cable, 30 ft

Part Number 7403030 3M Product Number 7403030 3M ID 7012820259

Details

9m cable lifeline assembly for horizontal lifeline systems
9.5mm 7x19 galvanised cable lifeline
Various lengths and individual components are available
Built-in turnbuckle type tensioner
Metal energy absorber limits fall arrest forces
Karabiners at each end for fast and safe attachment
Equipped with RFID
Equipped with 3M™ Connected Safety ID (CSID)

Typical properties

Brands
SecuraSpan™
Case Quantity
1
Connected Safety ID Equipped
Yes
Install Type
Temporary/Portable
Lifeline Material
Galvanized Cable
Maximum Number of Workers
2 Per Span, 6 Total
Product Series
SecuraSpan™
Product Type
Lifeline/Component,

Dimensions and Classifications

Overall Length (Imperial)
30 ft
Overall Length (Metric)
9 m

3M™ DBI-SALA® Single-Span Horizontal Lifeline For Stanchions 7403050, Galvanized Cable, 50 ft

Part Number 7403050 3M Product Number 7403050 3M ID 7012820261

Details

9m cable lifeline assembly for horizontal lifeline systems
9.5mm 7x19 galvanised cable lifeline
Various lengths and individual components are available
Built-in turnbuckle type tensioner
Metal energy absorber limits fall arrest forces
Karabiners at each end for fast and safe attachment
Equipped with RFID
Equipped with 3M™ Connected Safety ID (CSID)

Typical properties

Brands
SecuraSpan™
Case Quantity
1
Connected Safety ID Equipped
Yes
Install Type
Temporary/Portable
Lifeline Material
Galvanized Cable
Maximum Number of Workers
2 Per Span, 6 Total
Product Series
SecuraSpan™
Product Type
Lifeline/Component,

Dimensions and Classifications

Overall Length (Imperial)
50 ft
Overall Length (Metric)
15 m

3M™ PELTOR™ X1 Earmuffs X1P3E/37275(AAD), Hard Hat Attached, 10 ea/Case

3M Product Number X1P3E 3M ID 7000104075 UPC 10093045937285

Details

Hard hat attached hearing protection with Noise Reduction Rating (NRR) of 21 dB for low to moderate noise exposure
Fits a wide range of industrial safety hard hats, including 3M™ H-700 Series Hard Hats (sold separately)
Attaches directly to many hard hats without an adapter
Earcups tilt to ensure a customized fit and comfort for individual users
Adjustable earcups may be placed in three positions: 1) Usage position 2) Stand-by position, or 3) Storage position

Typical properties

Attenuation Rating
21.0 Decibel
Brands
PELTOR™
Case Quantity
10
Corded
No
Dielectric
No
Earmuff Style
Hard Hat Attached
Electrically Insulated
No
Hearing Protection Style
Hard Hat Attached
Metal Detectable
No
Moisture Resistant
No
Prod

3M™ PELTOR™ Hard Hat Attached Electrically Insulated Earmuffs X1P5E, 10 EA/Case

3M Product Number X1P5E 3M ID 7100097525 UPC 10078371671003

Details

Electrically insulated: Appropriate for a wide range of applications*
High-performance arms: Balance durability and flexibility
Easy click in/ click out: Move cups on and off ears easily
Convenient storage: Store with cups clicked in or out
Compatibility with hard hats: Designed for use with a standard hard hat slot**
Fit can be confirmed: Verify with 3M™ E-A-Rfit™ Dual-Ear Validation System***
X1 Products are slim and lightweight: Comfortable for wearers, especially with other protective equipment

*These earmuff cups are made of non-conductive (sometimes referred to as “dielectric”) material while the metal components of the headbands and the helmet attachment mechanisms are covered in non-conductive material. This product was found to be electrically insulated, withstanding a voltage up to 1.2 kV, at an external laboratory against a modified test method based on EN 397:2012 under dry conditions. The user must determine the overall suitability of this product for the intended application taking into account any hazards other than noise for which this product is tested and approved. **This product was designed and tested with a 3M Hard Hat H700. For information on other hard hat models contact 3M. ***3M strongly recommends fit testing of hearing protectors. Research suggests that many users will receive less noise reduction than indicated by the NRR due to variation in earmuff fit, earmuff fitting skill and motivation of the user. If NRR is used, 3M recommends that it be reduced by 50% or in accordance with applicable regulations

Typical properties

Attenuation Rating
21.0 Decibel
Bluetooth
No
Brands
PELTOR™
Case Quantity
10
Corded
No
Dielectric
Yes
Earmuff Style
Hard Hat Attached
Electrically Insulated
Yes
Hearing Protection Style
Hard Hat Attached
Hearing Protection Type
Hard Hat

3M™ PELTOR™ X1 Earmuffs X1A/37270(AAD), Over-the-Head, 10 EA/Case

3M Product Number X1A 3M ID 7000104070 UPC 10093045937230

Details

Over-the-head hearing protection with Noise Reduction Rating (NRR) of 22 dB for low to moderate noise exposures

Twin headband design helps reduce heat buildup with good fit and balance

Wire headband offers comfortable pressure during prolonged usage

Earcups tilt to ensure a customized fit and comfort for individual users

Electrically insulated (dielectric) wire headband helps reduce exposure to electrical hazards

Typical properties

Attenuation Rating

22.0 Decibel

Bluetooth

No

Brands

PELTOR™

Case Quantity

10

Corded

No

Dielectric

Yes

Earmuff Style

Over the Head

Electrically Insulated

Yes

Hearing Protection Style

Over-the-Head

Hygiene Kit

HYX1

Metal Detectable

No

3M™ Versaflo™ Replacement Head Suspension M-350, for use with M-300 and M-400 Hardhats 1 EA/Case

3M Product Number M-350 3M ID 7000127679

Details

Replacement head suspension for M-300 and M-400 Series helmets

Typical properties

Brands
Versaflo™
Compatible With
3M™ Versaflo™ M-400 Series Helmets
Headgear Type
Hardhat with Faceshield
High Heat
No
Product Color
Black
Product Series
M-Series
Product Type
Suspension

3M™ Professional Series Half Facepiece Paint Spray Packout 37079, Large 4 EA/Case

Part Number 37079 3M ID 7010341232 UPC 00051131370791

Details

Packout includes: Half Facepiece 7503/37083(AAD), Large, 1 pair 3M™ Organic Vapor Cartridge 07046, 1 pair 3M™ Retainer 07054, and 2 pairs of 3M™ Particulate Filter 5P71/07194(AAD), P95 swept back cartridge design
Spray paint applications
For occupational use only

Typical properties

Brands
3M™
Connection Type
Bayonet
Facepiece Material
Silicone
Mask Size
Large
Recommended Industry
Marine
Replaceable Cartridge Included
Yes
eClass 14 Classification Group
40220112

3M™ Speedglas™ G5-01 Long Battery Power Cable for Task Light, 46-0500-02, 1 EA/Bag

3M Product Number 46-0500-02 3M ID 7100216920 UPC 00076308944759

Details

For maximum safety and comfort, make it a habit to check your equipment regularly
Replace worn out or damaged parts

Typical properties

Brands

Speedglas™

Compatible Welding Helmet

G5-01 Welding Helmets

Product Color

Black

Product Series

G5

Product Type

Power Cable

Recommended Application

Grinding, Metal Processing, Metal Repair, Welding

Recommended Industry

General Manufactur

3M™ Speedglas™ G5-01 Short Helmet Power Cable for Task Light, 46-0500-03, 1 EA/Bag

3M Product Number 46-0500-03 3M ID 7100216994 UPC 00076308944766

Details

For maximum safety and comfort, make it a habit to check your equipment regularly

Replace worn out or damaged parts

Contains many servicable parts

May reduce the battery run time of the 3M™ Adflo™ Powered Air Respirator

Typical properties

Brands

Speedglas™

Compatible Welding Helmet

G5-01 Welding Helmets

Product Color

Black

Product Series

G5

Product Type

Power Cable

Recommended Application

Grinding, Metal Processing, Metal Repair, Welding

Recommended Industry

General Manufactur

3M™ Speedglas™ G5-01 Task Light, No Power Cables Included, 46-0500-05, 1 EA/Bag

3M Product Number 46-0500-05 3M ID 7100217182 UPC 00076308944964

Details

Used if the original task light becomes worn or damaged
No cables or protection plates included
For maximum safety and comfort, make it a habit to check your equipment regularly
Replace worn out or damaged parts

Typical properties

Brands
Speedglas™
Case Quantity
1 EA/Case
Compatible Welding Helmet
G5-01 Welding Helmets
Product Color
Black
Product Series
G5
Product Type
Light
Recommended Application
Grinding, Metal Processing, Metal Repair, Welding
Recommended Industry

3M™ Speedglas™ G5-01 Magnifying Lens Holder, 46-0680-00, 1 EA/Case

3M Product Number 46-0680-00 3M ID 7100215539 UPC 00076308944841

Details

Magnifying lens are sold separately and available in 1.5X, 2.0X, 2.5X, and 3.0X
For maximum safety and comfort, make it a habit to check your equipment regularly
Replace worn out or damaged parts

Typical properties

Brands
Speedglas™
Compatible Welding Helmet
G5-01 Welding Helmets
Product Color
Black
Product Series
G5
Product Type
Lens Holder
Recommended Application
Grinding, Metal Processing, Metal Repair, Welding
Recommended Industry
General Manufactur

3M™ PELTOR™ CH-3 Headset MT74H52A-110, Headband, FLX2, 1 ea/Case

3M Product Number MT74H52A-110 3M ID 7100203637 UPC 04054596695573

Details

Protective communication solution for hands-free, clear communication in noisy environments

FLX2 connection jack for easy and reliable connection to a wide assortment of handheld devices

Lasting comfort for long duration wear times

Designed to withstand harsh environmental elements

Water and dust-proof noise-cancelling microphone (IP68) for clear speech transmission in noisy and harsh environments

Audio speakers are optimized for speech frequencies and meet the efficiency demands of many of today's digital devices

Bright yellow color for enhanced visibility

Flexible yet sturdy headband design adapts to a wide variety of head shapes and sizes

Typical properties

Attenuation Rating

26 dB

Audio Type

Communication

Auxiliary Port

FLX2

Brands

PELTOR™

CSA Class

CSA Class A

Case Quantity

1

Communication Direction

Two-way

Communication Type

External Audio Input

Communication via External 2-Way Radio

Yes

3M™ DBI-SALA® Reusable Heavy-Duty Roof Anchor 2103673

Part Number 2103673 3M Product Number 2103673 3M ID 7100228426

Details

Durable materials and hardware designed to help stand up to harsh working conditions
Compatible with various fall arrest systems, not compliant for use with Horizontal Lifelines
Suitable for use in general industrial and construction industries
Compact, lightweight design
Meets the requirements for 29 CFR OSHA 1910.140 and 29 CFR OSHA 1926.502
Features corrosion-resistant, steel and aluminum construction for durability
This safety equipment is designed for use with additional personal protective equipment (PPE)
Fastener kit included for fast and easy nail or screw installation
Low-profile design stays out of the way as you work

Typical properties

Anchor Install Type
Reusable
Attachment Type
Nail/Screw
Brands
DBI-SALA®
Case Quantity
1
Connected Safety ID Equipped
No
Dimensions
25.00x0.25x3.00in
Install Type
Reusable
Material
Steel
Product Color
Black
Product Type
Reusable Heavy-D

3M™ DBI-SALA® Derrick Tongue Buckle Positioning Belt with Tongue Buckle Harness Connector 1003220, Yellow, Medium

Part Number 1003220 3M Product Number 1003220 3M ID 7012815130

Details

Body belts available in designs to be used independently, as well as other versions to be used with 3M Fall Protection Harnesses

Multiple sizes available

Meets applicable regulatory standards

Typical properties

Belly Pad

Yes

Belt Type

Waist

Board/Seat Cushion

No

Brands

DBI-SALA®

Buckle Material

Stainless Steel Grommet

Buckle Type

Tongue Buckle

Case Quantity

1

Connected Safety ID Equipped

No

D-ring Material

Zinc Plated Steel

D-ring Placement

Do

3M™ DBI-SALA® Tongue Buckle Restraint Belt with Hip Pad 1000004, Yellow, Large

3M Product Number 1000004 3M ID 7012814927 UPC 00840779004362

Details

Body belts available in designs to be used independently, as well as other versions to be used with 3M Fall Protection Harnesses

Multiple sizes available

Meets applicable regulatory standards

Typical properties

Belly Pad

No

Belt Type

Waist

Board/Seat Cushion

No

Brands

DBI-SALA®

Buckle Material

Stainless Steel Grommet

Buckle Type

Tongue Buckle

Case Quantity

1

Connected Safety ID Equipped

Yes

D-ring Material

Zinc Plated Steel

D-ring Placement

Ba

3M™ DBI-SALA® Derrick Positioning Belt with Pass-Thru Suspension Strap Harness Connector 1000570, Yellow, Universal

Part Number 1000570 3M Product Number 1000570 3M ID 7100268010

Details

Body belts available in designs to be used independently, as well as other versions to be used with 3M Fall Protection Harnesses

Multiple sizes available

Meets applicable regulatory standards

Typical properties

Belly Pad

Yes

Belt Type

Waist

Board/Seat Cushion

No

Brands

DBI-SALA®

Buckle Material

Zinc Plated Steel

Buckle Type

Pass-through

Case Quantity

1

Connected Safety ID Equipped

No

D-ring Material

Forged Steel

D-ring Placement

Double Front

3M™ DBI-SALA® ExoFit NEX™ Tongue Buckle Belt 1000783, Gray, 2X

Part Number 1000783 3M Product Number 1000783 3M ID 7012815026

Details

Body belts available in designs to be used independently, as well as other versions to be used with 3M Fall Protection Harnesses
Multiple sizes available
Meets applicable regulatory standards

Typical properties

Belly Pad
No
Belt Type
Waist
Board/Seat Cushion
No
Brands
DBI-SALA®
Buckle Material
Stainless Steel Grommet
Buckle Type
Tongue Buckle
Case Quantity
1
Connected Safety ID Equipped
Yes
Hip Pad
No
Material
Polyester
Max Free Fall Allowed

3M™ DBI-SALA® ExoFit NEX™ Tongue Buckle Belt 1000782, Gray, X-Large

Part Number 1000782 3M Product Number 1000782 3M ID 7012815025

Details

Body belts available in designs to be used independently, as well as other versions to be used with 3M Fall Protection Harnesses

Multiple sizes available

Meets applicable regulatory standards

Typical properties

Belly Pad

No

Belt Type

Waist

Board/Seat Cushion

No

Brands

DBI-SALA®

Buckle Material

Stainless Steel Grommet

Buckle Type

Tongue Buckle

Case Quantity

1

Connected Safety ID Equipped

Yes

Hip Pad

No

Material

Polyester

Max Free Fall Allowed

3M™ DBI-SALA® Tongue Buckle Belt 1000056, Yellow, 2X

Part Number 1000056 3M Product Number 1000056 3M ID 7012814954

Details

Body belts available in designs to be used independently, as well as other versions to be used with 3M Fall Protection Harnesses
Multiple sizes available
Meets applicable regulatory standards

Typical properties

Belly Pad
No
Belt Type
Waist
Board/Seat Cushion
No
Brands
DBI-SALA®
Buckle Material
Stainless Steel Grommet
Buckle Type
Tongue Buckle
Case Quantity
1
Connected Safety ID Equipped
Yes
Hip Pad
No
Material
Polyester/Nylon
Max Free Fall Al

3M™ DBI-SALA® 3-Man Swiveling Roof Anchor 2103690

Part Number 2103690 3M Product Number 2103690 3M ID 7100228428

Details

Durable materials and hardware designed to help stand up to harsh working conditions
Compatible with various fall arrest systems, not compliant for use with Horizontal Lifelines
Suitable for use in general industrial and construction industries
Compact, lightweight design
Meets the requirements for 29 CFR OSHA 1910.140 and 29 CFR OSHA 1926.502
Features corrosion-resistant, steel and aluminum construction for durability
This safety equipment is designed for use with additional personal protective equipment (PPE)
Installs to roof peak to provide a tie-off point for a fall protection system. Installs to sloped wood roof structures. Fastener kit included
Keeps fall protection lifelines off of roof deck for enhanced ease and mobility.
Portable and reusable
Fall arrest- and restraint-rated for three workers
Measures 54 in. (137.2 cm) height when fully extended

Typical properties

Anchor Install Type
Reusable
Attachment Type
Screw
Brands
DBI-SALA®
Case Quantity
1
Connected Safety ID Equipped
No
D-ring Material
Zinc Plated Steel
Dimensions
36.00x36.00x54.00in
Install Type
Reusable
Product Color
Blue, Silver
Product

3M™ DBI-SALA® Tongue Buckle Restraint Belt 1000164, Yellow, Large

Part Number 1000164 3M Product Number 1000164 3M ID 7012814967

Details

Body belts available in designs to be used independently, as well as other versions to be used with 3M Fall Protection Harnesses

Multiple sizes available

Meets applicable regulatory standards

Typical properties

Belly Pad

No

Belt Type

Waist

Board/Seat Cushion

No

Brands

DBI-SALA®

Buckle Material

Stainless Steel Grommet

Buckle Type

Tongue Buckle

Case Quantity

1

Connected Safety ID Equipped

Yes

D-ring Material

Zinc Plated Steel

D-ring Placement

FI

3M™ DBI-SALA® Derrick Tongue Buckle Positioning Belt with Tongue Buckle Harness Connector 1003224, Yellow, 3X

Part Number 1003224 3M Product Number 1003224 3M ID 7012815134

Details

Body belts available in designs to be used independently, as well as other versions to be used with 3M Fall Protection Harnesses

Multiple sizes available

Meets applicable regulatory standards

Typical properties

Belly Pad

Yes

Belt Type

Waist

Board/Seat Cushion

No

Brands

DBI-SALA®

Buckle Material

Stainless Steel Grommet

Buckle Type

Tongue Buckle

Case Quantity

1

Connected Safety ID Equipped

No

D-ring Material

Zinc Plated Steel

D-ring Placement

Do

3M™ DBI-SALA® Derrick Tongue Buckle Positioning Belt with Pass-Thru Harness Connector 1000542, Yellow, Small

Part Number 1000542 3M Product Number 1000542 3M ID 7012814982

Details

Body belts available in designs to be used independently, as well as other versions to be used with 3M Fall Protection Harnesses

Multiple sizes available

Meets applicable regulatory standards

Typical properties

Belly Pad

Yes

Belt Type

Waist

Board/Seat Cushion

No

Brands

DBI-SALA®

Buckle Material

Stainless Steel Grommet and Zinc Plated Steel

Buckle Type

Tongue Buckle

Case Quantity

1

Connected Safety ID Equipped

No

D-ring Material

Zinc Plated Steel

3M™ DBI-SALA® Tongue Buckle Positioning Belt with Hip Pad 1000024, Yellow, Large

3M Product Number 1000024 3M ID 7012814942 UPC 00840779004386

Details

Body belts available in designs to be used independently, as well as other versions to be used with 3M Fall Protection Harnesses

Multiple sizes available

Meets applicable regulatory standards

Typical properties

Belly Pad

No

Belt Type

Waist

Board/Seat Cushion

No

Brands

DBI-SALA®

Buckle Material

Stainless Steel Grommet

Buckle Type

Tongue Buckle

Case Quantity

1

Connected Safety ID Equipped

Yes

D-ring Material

Zinc Plated Steel

D-ring Placement

Si

3M™ DBI-SALA® Tongue Buckle Restraint Belt with Hip Pad 1000002, Yellow, Small

3M Product Number 1000002 3M ID 7012814923 UPC 00840779004348

Details

Body belts available in designs to be used independently, as well as other versions to be used with 3M Fall Protection Harnesses

Multiple sizes available

Meets applicable regulatory standards

Typical properties

Belly Pad

No

Belt Type

Waist

Board/Seat Cushion

No

Brands

DBI-SALA®

Buckle Material

Stainless Steel Grommet

Buckle Type

Tongue Buckle

Case Quantity

1

Connected Safety ID Equipped

Yes

D-ring Material

Zinc Plated Steel

D-ring Placement

Ba

3M™ DBI-SALA® Derrick Tongue Buckle Positioning Belt with Tongue Buckle Harness Connector 1003221, Yellow, Large

Part Number 1003221 3M Product Number 1003221 3M ID 7012815131

Details

Body belts available in designs to be used independently, as well as other versions to be used with 3M Fall Protection Harnesses

Multiple sizes available

Meets applicable regulatory standards

Typical properties

Belly Pad

Yes

Belt Type

Waist

Board/Seat Cushion

No

Brands

DBI-SALA®

Buckle Material

Zinc Plated Steel

Buckle Type

Tongue Buckle

Case Quantity

1

Connected Safety ID Equipped

No

D-ring Material

Forged Steel

D-ring Placement

Double Front

3M™ DBI-SALA® Derrick Tongue Buckle Positioning Belt with Pass-Thru Harness Connector 1000546, Yellow, 2X

3M Product Number 1000546 3M ID 7012814986 UPC 00840779014873

Details

Body belts available in designs to be used independently, as well as other versions to be used with 3M Fall Protection Harnesses

Multiple sizes available

Meets applicable regulatory standards

Typical properties

Belly Pad

Yes

Belt Type

Waist

Board/Seat Cushion

No

Brands

DBI-SALA®

Buckle Material

Stainless Steel Grommet and Zinc Plated Steel

Buckle Type

Tongue Buckle

Case Quantity

1

Connected Safety ID Equipped

No

D-ring Material

Zinc Plated Steel

3M™ DBI-SALA® Tongue Buckle Restraint Belt with Hip Pad 1000005, Yellow, X-Large

3M Product Number 1000005 3M ID 7100246614 UPC 00840779007455

Details

Body belts available in designs to be used independently, as well as other versions to be used with 3M Fall Protection Harnesses

Multiple sizes available

Meets applicable regulatory standards

Typical properties

Belly Pad

No

Belt Type

Waist

Board/Seat Cushion

No

Brands

DBI-SALA®

Buckle Material

Stainless Steel Grommet

Buckle Type

Tongue Buckle

Case Quantity

1

Connected Safety ID Equipped

Yes

D-ring Material

Zinc Plated Steel

D-ring Placement

Ba

3M™ DBI-SALA® ExoFit™ Tongue Buckle Belt 1000709, Gray, Medium

Part Number 1000709 3M Product Number 1000709 3M ID 7012815011

Details

Body belts available in designs to be used independently, as well as other versions to be used with 3M Fall Protection Harnesses

Multiple sizes available

Meets applicable regulatory standards

Typical properties

Belly Pad

No

Belt Type

Waist

Board/Seat Cushion

No

Brands

DBI-SALA®

Buckle Material

Stainless Steel Grommet

Buckle Type

Tongue Buckle

Case Quantity

1

Connected Safety ID Equipped

Yes

Hip Pad

No

Material

Polyester

Max Free Fall Allowed

3M™ DBI-SALA® Tongue Buckle Restraint Belt with Hip Pad 1000001, Yellow, X-Small

Part Number 1000001 3M Product Number 1000001 3M ID 7012814922

Details

Body belts available in designs to be used independently, as well as other versions to be used with 3M Fall Protection Harnesses

Multiple sizes available

Meets applicable regulatory standards

Typical properties

Belly Pad

No

Belt Type

Waist

Board/Seat Cushion

No

Brands

DBI-SALA®

Buckle Material

Stainless Steel Grommet

Buckle Type

Tongue Buckle

Case Quantity

1

Connected Safety ID Equipped

Yes

D-ring Material

Zinc Plated Steel

D-ring Placement

Ba

3M™ DBI-SALA® Tongue Buckle Positioning Belt with Hip Pad 1000026, Yellow, 2X

Part Number 1000026 3M Product Number 1000026 3M ID 7012814946

Details

Body belts available in designs to be used independently, as well as other versions to be used with 3M Fall Protection Harnesses

Multiple sizes available

Meets applicable regulatory standards

Typical properties

Belly Pad

No

Belt Type

Waist

Board/Seat Cushion

No

Brands

DBI-SALA®

Buckle Material

Stainless Steel Grommet

Buckle Type

Tongue Buckle

Case Quantity

1

Connected Safety ID Equipped

Yes

D-ring Material

Zinc Plated Steel

D-ring Placement

Si

3M™ DBI-SALA® Derrick Tongue Buckle Positioning Belt with Pass-Thru Harness Connector 1000547, Yellow, 3X

Part Number 1000547 3M Product Number 1000547 3M ID 7012814987

Details

Body belts available in designs to be used independently, as well as other versions to be used with 3M Fall Protection Harnesses

Multiple sizes available

Meets applicable regulatory standards

Typical properties

Belly Pad

Yes

Belt Type

Waist

Board/Seat Cushion

No

Brands

DBI-SALA®

Buckle Material

Stainless Steel Grommet and Zinc Plated Steel

Buckle Type

Tongue Buckle

Case Quantity

1

Connected Safety ID Equipped

No

D-ring Material

Zinc Plated Steel

3M™ DBI-SALA® ExoFit NEX™ Tongue Buckle Belt 1000780, Gray, Medium

Part Number 1000780 3M Product Number 1000780 3M ID 7012815023

Details

Body belts available in designs to be used independently, as well as other versions to be used with 3M Fall Protection Harnesses

Multiple sizes available

Meets applicable regulatory standards

Typical properties

Belly Pad

No

Belt Type

Waist

Board/Seat Cushion

No

Brands

DBI-SALA®

Buckle Material

Stainless Steel Grommet

Buckle Type

Tongue Buckle

Case Quantity

1

Connected Safety ID Equipped

Yes

Hip Pad

No

Material

Polyester

Max Free Fall Allowed

3M™ DBI-SALA® Tongue Buckle Belt 1000055, Yellow, X-Large

Part Number 1000055 3M Product Number 1000055 3M ID 7012814953

Details

Body belts available in designs to be used independently, as well as other versions to be used with 3M Fall Protection Harnesses
Multiple sizes available
Meets applicable regulatory standards

Typical properties

Belly Pad
No
Belt Type
Waist
Board/Seat Cushion
No
Brands
DBI-SALA®
Buckle Material
Stainless Steel Grommet
Buckle Type
Tongue Buckle
Case Quantity
1
Connected Safety ID Equipped
Yes
Hip Pad
No
Material
Polyester/Nylon
Max Free Fall Al

3M™ DBI-SALA® Tongue Buckle Restraint Belt with Hip Pad 1000003, Yellow, Medium

3M Product Number 1000003 3M ID 7012814925 UPC 00840779004355

Details

Body belts available in designs to be used independently, as well as other versions to be used with 3M Fall Protection Harnesses

Multiple sizes available

Meets applicable regulatory standards

Typical properties

Belly Pad

No

Belt Type

Waist

Board/Seat Cushion

No

Brands

DBI-SALA®

Buckle Material

Stainless Steel Grommet

Buckle Type

Tongue Buckle

Case Quantity

1

Connected Safety ID Equipped

Yes

D-ring Material

Zinc Plated Steel

D-ring Placement

Ba

3M™ DBI-SALA® ExoFit™ Tongue Buckle Belt 1000708, Gray, Small

Part Number 1000708 3M Product Number 1000708 3M ID 7012815010

Details

Body belts available in designs to be used independently, as well as other versions to be used with 3M Fall Protection Harnesses
Multiple sizes available
Meets applicable regulatory standards

Typical properties

Belly Pad
No
Belt Type
Waist
Board/Seat Cushion
No
Brands
DBI-SALA®
Buckle Material
Stainless Steel Grommet
Buckle Type
Tongue Buckle
Case Quantity
1
Connected Safety ID Equipped
Yes
Hip Pad
No
Material
Polyester
Max Free Fall Allowed

3M™ PELTOR™ Tactical Earplug TEP-300 TN, Tan

3M Product Number TEP-300 TN 3M ID 7100227637 UPC 00638060429877

Details

Wireless - Utilizing near field magnetic induction, 3M™ PELTOR™ Tactical Earplugs, TEP-300 can be wirelessly connected to the 3M™ PELTOR™ System Control Unit, SCU-300 (not included)

Compact Hearing Protection - Comes with multiple sizes and types of replaceable eartips, designed to help provide hearing protection

Situational Awareness - 3M™ PELTOR™ Tactical Earplugs, features environmental listening function – a capability designed to help provide auditory situational awareness, while still helping provide protection from hazardous noise

In Ear Speech Microphone - The TEP-300 features in-ear, acoustical, speech communications microphones which pick up sound waves from your voice as you speak

Portable Charging Case - Up to 16 recharging cycles with AA or AAA batteries

Micro USB-C Charging Port - USB port enables the charging of the earplugs when plugged into a computer or wall socket (cable not included)

3M strongly recommends individual fit testing of hearing protectors. If the NRR is used to estimate typical workplace protection, 3M recommends that the noise reduction value be reduced by 50% or in accordance with applicable regulations

Typical properties

Attenuation Rating

30 dB, 23 dB

Battery Life

Approx. 10 hours

Battery Type

Lithium-ion Rechargeable

Brands

PELTOR™

Case Quantity

20 Kit / Case

Communication Type

Ambient Listening

Hearing Protection Style

In-Ear

Product Color

Tan

Product Se

3M™ DBI-SALA® Confined Space Permanent Deck Mount Sleeve Davit Mast Base 8515162, Zinc Plated Steel

Part Number 8515162 3M Product Number 8515162 3M ID 7100280644

Details

Deck mount sleeve davit base and mounting hardware
Available in aluminum, stainless steel, galvanized and zinc-plated steel
Slips into 4 in. (10.1 cm) hole in existing flooring
Sandblasted surface finish

Typical properties

Brands
DBI-SALA®
Case Quantity
1
Connected Safety ID Equipped
No
Dimensions
20.60x20.60x25.40cm
Install Type
Portable
Net Weight (Imperial)
16.8 lb
Net Weight (Metric)
7.6 kg
Product Series
Advanced™
Recommended Industry
Construction, Gen

3M™ DBI-SALA® Confined Space Permanent Deck Mount Sleeve Davit Mast Base 8515834, Stainless Steel

Part Number 8515834 3M Product Number 8515834 3M ID 7100274752

Details

Deck mount sleeve davit base and mounting hardware
Available in aluminum, stainless steel, galvanized and zinc-plated steel
Slips into 4 in. (10.1 cm) hole in existing flooring
Sandblasted surface finish

Typical properties

Brands
DBI-SALA®
Case Quantity
1
Connected Safety ID Equipped
No
Dimensions
20.60x20.60x25.40cm
Install Type
Portable
Net Weight (Imperial)
18.9 lb
Net Weight (Metric)
8.6 kg
Product Series
Advanced™
Recommended Industry
Construction, Gen

3M™ DBI-SALA® Flexiguard™ Truck Hitch Joint Adaptor 8511401, Zinc Plated Steel

Part Number 8511401 3M Product Number 8511401 3M ID 7012820550

Details

Universal joint assembly
Allows the base to be pivoted
Installs between the 8510140 hitch mount sleeve or extension
Weight: 10 lbs. (4.5 kg)

Typical properties

Brands
Advanced™
Case Quantity
1
Connected Safety ID Equipped
No
Dimensions
15.00x2.00x2.00in
Install Type
Portable
Net Weight (Imperial)
9.92 lb
Net Weight (Metric)
4.5 kg
Product Color
Silver
Product Series
Advanced™
Product Type
Vehi

3M™ Connected Safety ID Mechanical Mount HF RFID Tag CSID-POUCH, 9505841, Black, 25/Pack, 1 ea/Case

3M Product Number RFID-POUCH 3M ID 7010315367 UPC 00051131274228

Details

Durable, heavy-duty construction
Pouch has a built-in choker and snap strap
RFID tag utilizes passive high frequency 13.56 MHz technology and is pre-programmed with a unique ID
Ready for use with 3M™ Safety & Inspection Manager

Typical properties

Brands
3M™
Dimensions
2.70x2.00x0.30 (in)
Material
Nylon
Operating Frequency
13.56 MHz (HF)
Operating Temperature
-35°C to 85°C / -31°F to 185°F
Product Color
Black
Product Type
RFID Tags
Recommended Application
Safety Program Management
R

3M™ DBI-SALA® Flexiguard™ M100 & M200 Modular Jib Smooth Surface Leveling Caster Assembly 8530908

3M Product Number 8530908 3M ID 7100280605 UPC 00648250177396

Details

Kit comes with 4 wheel assemblies and required fasteners
Designed to enable system transport
Helps maximize usage in various locations

Typical properties

Brands
DBI-SALA®
Connected Safety ID Equipped
No
Install Type
Temporary/Portable
Manufacturing Origin
Mexico
Mounting Type
Surface
Net Weight (Imperial)
152 lb
Net Weight (Metric)
68.95 kg
Product Series
FlexiGuard™
Product Type
Modular J

Dimensions and Classifications

Overall Height (Metric)
1050 mm
Overall Length (Metric)
1200 mm
Overall Width (Metric)
90 mm

3M™ DBI-SALA® Small Series Load Arrestor 3700400, Galvanized Cable, 880 lb Capacity, 26 ft

Part Number 3700400 3M Product Number 3700400 3M ID 7012819496

Details

- Arrests accidental fall of heavy objects
- 880 lb. (400 kg) load capacity
- 26.2 ft. (8 m) of 1/4" (6 mm) galvanized cable
- Inertia activated brake with indicator button
- Energy absorbing system
- Self retracting lifeline
- Portable and self contained system
- Heavy-duty durable construction

Typical properties

- Brands
 - DBI-SALA®
- Cable Length (Imperial)
 - 26.2 ft
- Cable Length (Metric)
 - 8 m
- Case Quantity
 - 1
- Connected Safety ID Equipped
 - No
- Dimensions
 - 8.00x4.50x10.40in
- Lifeline Material
 - Galvanized Cable
- Product Series
 - Load Arrestor™
- Product Type
 - Load Arr

Dimensions and Classifications

- Overall Length (Imperial)
 - 7.9 ft
- Overall Length (Metric)
 - 7.9 m

3M™ DBI-SALA® Small Series Load Arrestor 3700501, Galvanized Cable, 1100 lb Capacity, 17 ft

3M Product Number 3700501 3M ID 7012819497 UPC 00840779002535

Details

- Arrests accidental fall of heavy objects
- 1,100 lb. (500 kg) load capacity
- 17 ft. (5.2 m) of 9/32" (7 mm) galvanized cable
- Inertia activated brake with indicator button
- Energy absorbing system
- Self retracting lifeline
- Portable and self contained system
- Heavy-duty durable construction

Typical properties

- Brands
 - DBI-SALA®
- Cable Length (Imperial)
 - 16.4 ft
- Cable Length (Metric)
 - 5 m
- Case Quantity
 - 1
- Connected Safety ID Equipped
 - No
- Dimensions
 - 8.00x4.50x10.40in
- Lifeline Material
 - Galvanized Cable
- Product Series
 - Load Arrestor™
- Product Type
 - Load Arr

Dimensions and Classifications

- Overall Length (Imperial)
 - 17 ft
- Overall Length (Metric)
 - 5.29 m

3M™ DBI-SALA® Small Series Load Arrestor with Pulley 3700801, Galvanized Cable, 1760 lb Capacity, 13 ft

Part Number 3700801 3M Product Number 3700801 3M ID 7012819498

Details

- Arrests accidental fall of heavy objects
- 1,760 lb. (800 kg) load capacity
- 13 ft. (4 m) of 1/4" (6 mm) galvanized cable
- Includes pulley to achieve maximum load rating
- Inertia activated brake with indicator button
- Energy absorbing system
- Self retracting lifeline
- Portable and self contained system
- Heavy-duty durable construction

Typical properties

- Brands
 - DBI-SALA®
- Cable Length (Imperial)
 - 13.1 ft
- Cable Length (Metric)
 - 4 m
- Case Quantity
 - 1
- Connected Safety ID Equipped
 - No
- Dimensions
 - 8.00x4.50x10.40in
- Lifeline Material
 - Galvanized Cable
- Product Series
 - Load Arrestor™
- Product Type
 - Load Arr

Dimensions and Classifications

- Overall Length (Imperial)
 - 13 ft
- Overall Length (Metric)
 - 3.9 m

3M™ CSID Connected Safety ID Choker Mount HF RFID Tag 9505841, Black, 25 ea/Pack

Part Number 9505841 3M Product Number 9505841 3M ID 7100314321

Details

- RFID tag 25-pack for soft goods
- Utilises passive high frequency 13.56 MHz technology
- Built-in choker, snap strap and zip ties included
- Lightweight and durable nylon construction
- Easily track inspections
- Control inventory and use
- Reliable information management
- Multiple system versions available

Typical properties

- Brands
- 3M™
- eClass 14 Classification Group
- 27280401

**3M™ CSID Connected Safety ID Mechanical Mount HF RFID Tag
9505839,
Yellow, 25 ea/Pack**

3M Product Number 9505839 3M ID 7100314320 UPC 00648250173688

Details

RFID tag 25-pack for hardgoods
Utilises passive high frequency 13.56 MHz technology
Key ring, adhesive and zip tie attachments included
Heavy-duty thermoplastic composite construction
Unique ID code programmed and printed on each tag
Easily track inspections
Control inventory and use
Reliable information management
Multiple system versions available

Typical properties

Brands
3M™
Case Quantity
1
Dimensions
2.30x1.50x0.40in
Product Color
Yellow
Product Type
Hardgoods HF RFID Tag
Recommended Industry
Construction, General Industrial, Mining, Oil & Gas, Transportation, Utilities, Wind
Energy
Weight (Imperial)

3M™ DBI-SALA® Nano-Lok™ Hot Work Personal Self-Retracting Lifeline 3100564, Kevlar® Fiber Web, 6 ft

3M Product Number 3100564 3M ID 7012818542 UPC 00648250242650

Details

- Constructed with Kevlar® fiber webbing
- Kevlar® protected energy absorber
- Quick activating speed sensing brake system
- Self-locking snap hook on the lifeline
- 420 lbs. (190 kg) weight capacity

Typical properties

- ANSI Class Level
- Class 1
- Average Arrest Force (Imperial)
- 1125 lbf (ANSI), 1125 lbf (OSHA 130 lb - 310 lb), 1125 lbf (OSHA up to 420 lb)
- Average Arrest Force (Metric)
- 5 kN (ANSI)
- Brands
- DBI-SALA®
- Connected Safety ID Equipped
- Yes
- Harness Connectio

Dimensions and Classifications

- Overall Length (Imperial)
- 6 ft
- Overall Length (Metric)
- 1.83 m

3M™ DBI-SALA® Nano-Lok™ Hot Work Self-Retracting Lifeline with Anchor Hook 3100562, Kevlar® Fiber Web, 6 ft

3M Product Number 3100562 3M ID 7012828668 UPC 00648250242636

Details

Constructed with Kevlar® fiber webbing
Kevlar® protected energy absorber
Quick activating speed sensing brake system
Self-locking snap hook on the lifeline
420 lbs. (190 kg) weight capacity

Typical properties

ANSI Class Level
Class 1
Anchor Connection Type
Carabiner
Anchor Hook Material
Zinc Plated Steel
Anchor Hook Material
Zinc Plated Steel
Average Arrest Force (Imperial)
1125 lbf (ANSI), 1125 lbf (OSHA 130 lb - 310 lb), 1125 lbf (OSHA up to 420 lb)

Dimensions and Classifications

Overall Length (Imperial)
6 ft
Overall Length (Metric)
1.83 m

3M™ DBI-SALA® Nano-Lok™ Hot Work Twin-Leg Personal Self-Retracting Lifeline 3100566, Kevlar® Fiber Web, 6 ft

3M Product Number 3100566 3M ID 7012818544 UPC 00648250242674

Details

- Constructed with Kevlar® fiber webbing
- Kevlar® protected energy absorber
- Quick activating speed sensing brake system
- Self-locking snap hook on the lifeline
- 420 lbs. (190 kg) weight capacity

Typical properties

- ANSI Class Level
- Class 1
- Average Arrest Force (Imperial)
- 1125 lbf (ANSI), 1125 lbf (OSHA 130 lb - 310 lb), 1125 lbf (OSHA up to 420 lb)
- Average Arrest Force (Metric)
- 5 kN (ANSI)
- Brands
- DBI-SALA®
- Connected Safety ID Equipped
- Yes
- Harness Connectio

Dimensions and Classifications

- Overall Length (Imperial)
- 6 ft
- Overall Length (Metric)
- 1.83 m

3M™ DBI-SALA® Nano-Lok™ Hot Work Twin-Leg Personal Self-Retracting Lifeline 3100565, Kevlar® Fiber Web, 6 ft

3M Product Number 3100565 3M ID 7012818543 UPC 00648250242667

Details

- Constructed with Kevlar® fiber webbing
- Kevlar® protected energy absorber
- Quick activating speed sensing brake system
- Self-locking snap hook on the lifeline
- 420 lbs. (190 kg) weight capacity

Typical properties

- ANSI Class Level
- Class 1
- Average Arrest Force (Imperial)
- 1125 lbf (ANSI), 1125 lbf (OSHA 130 lb - 310 lb), 1125 lbf (OSHA up to 420 lb)
- Average Arrest Force (Metric)
- 5 kN (ANSI)
- Brands
- DBI-SALA®
- Connected Safety ID Equipped
- Yes
- Harness Connectio

Dimensions and Classifications

- Overall Length (Imperial)
- 6 ft
- Overall Length (Metric)
- 1.83 m

3M™ DBI-SALA® Nano-Lok™ Hot Work Twin-Leg Personal Self-Retracting Lifeline 3100568, Kevlar® Fiber Web, 6 ft

3M Product Number 3100568 3M ID 7012818546 UPC 00648250242698

Details

- Constructed with Kevlar® fiber webbing
- Kevlar® protected energy absorber
- Quick activating speed sensing brake system
- Self-locking snap hook on the lifeline
- 420 lbs. (190 kg) weight capacity

Typical properties

- ANSI Class Level
- Class 1
- Average Arrest Force (Imperial)
- 1125 lbf (ANSI), 1125 lbf (OSHA 130 lb - 310 lb), 1125 lbf (OSHA up to 420 lb)
- Average Arrest Force (Metric)
- 5 kN (ANSI)
- Brands
- DBI-SALA®
- Connected Safety ID Equipped
- Yes
- Harness Connectio

Dimensions and Classifications

- Overall Length (Imperial)
- 6 ft
- Overall Length (Metric)
- 1.83 m

3M™ DBI-SALA® Nano-Lok™ Hot Work Twin-Leg Personal Self-Retracting Lifeline 3100569, Kevlar® Fiber Web, 6 ft

3M Product Number 3100569 3M ID 7012818547 UPC 00648250242704

Details

Constructed with Kevlar® fiber webbing
Kevlar® protected energy absorber
Quick activating speed sensing brake system
Self-locking snap hook on the lifeline
420 lbs. (190 kg) weight capacity

Typical properties

ANSI Class Level
Class 1
Average Arrest Force (Imperial)
1125 lbf (ANSI), 1125 lbf (OSHA 130 lb - 310 lb), 1125 lbf (OSHA up to 420 lb)
Average Arrest Force (Metric)
5 kN (ANSI)
Brands
DBI-SALA®
Connected Safety ID Equipped
Yes
Harness Connectio

Dimensions and Classifications

Overall Length (Imperial)
6 ft
Overall Length (Metric)
1.83 m

3M™ DBI-SALA® Nano-Lok™ Twin-Leg Hot Work Self-Retracting Lifeline with Quick Connect 3100572, Web, Comfort Grip Hook, 6ft

3M Product Number 3100572 3M ID 7012818550 UPC 00648250242735

Details

Constructed with Kevlar® fiber webbing
Kevlar® protected energy absorber
Quick activating speed sensing brake system
Self-locking snap hook on the lifeline
420 lbs. (190 kg) weight capacity

Typical properties

ANSI Class Level
Class 1
Average Arrest Force (Imperial)
1125 lbf (ANSI), 1125 lbf (OSHA 130 lb - 310 lb), 1125 lbf (OSHA up to 420 lb)
Average Arrest Force (Metric)
5 kN (ANSI), 5 kN (OSHA up to 420 lb)
Brands
DBI-SALA®
Connected Safety ID Equipp

Dimensions and Classifications

Overall Length (Imperial)
6 ft
Overall Length (Metric)
1.83 m

3M™ DBI-SALA® Nano-Lok™ Hot Work Personal Self-Retracting Lifeline 3100557, Kevlar® Fiber Web, 6 ft

3M Product Number 3100557 3M ID 7012818539 UPC 00648250242582

Details

Constructed with Kevlar® fiber webbing
Kevlar® protected energy absorber
Quick activating speed sensing brake system
Self-locking snap hook on the lifeline
420 lbs. (190 kg) weight capacity

Typical properties

ANSI Class Level
Class 1
Average Arrest Force (Imperial)
1125 lbf (ANSI), 1125 lbf (OSHA 130 lb - 310 lb), 1125 lbf (OSHA up to 420 lb)
Average Arrest Force (Metric)
5 kN (ANSI)
Brands
DBI-SALA®
Connected Safety ID Equipped
Yes
Harness Connectio

Dimensions and Classifications

Overall Length (Imperial)
6 ft
Overall Length (Metric)
1.83 m

3M™ DBI-SALA® Nano-Lok™ Hot Work Personal Self-Retracting Lifeline 3100555, Kevlar® Fiber Web, 6 ft

3M Product Number 3100555 3M ID 7012818537 UPC 00648250242568

Details

Constructed with Kevlar® fiber webbing
Kevlar® protected energy absorber
Quick activating speed sensing brake system
Self-locking snap hook on the lifeline
420 lbs. (190 kg) weight capacity

Typical properties

ANSI Class Level
Class 1
Average Arrest Force (Imperial)
1125 lbf (ANSI), 1125 lbf (OSHA 130 lb - 310 lb), 1125 lbf (OSHA up to 420 lb)
Average Arrest Force (Metric)
5 kN (ANSI)
Brands
DBI-SALA®
Connected Safety ID Equipped
Yes
Harness Connectio

Dimensions and Classifications

Overall Length (Imperial)
6 ft
Overall Length (Metric)
1.83 m

3M™ DBI-SALA® Nano-Lok™ Hot Work Personal Self-Retracting Lifeline 3100556, Kevlar® Fiber Web, 6 ft

3M Product Number 3100556 3M ID 7012818538 UPC 00648250242575

Details

- Constructed with Kevlar® fiber webbing
- Kevlar® protected energy absorber
- Quick activating speed sensing brake system
- Self-locking snap hook on the lifeline
- 420 lbs. (190 kg) weight capacity

Typical properties

- ANSI Class Level
- Class 1
- Average Arrest Force (Imperial)
- 1125 lbf (ANSI), 1125 lbf (OSHA 130 lb - 310 lb), 1125 lbf (OSHA up to 420 lb)
- Average Arrest Force (Metric)
- 5 kN (ANSI)
- Brands
- DBI-SALA®
- Connected Safety ID Equipped
- Yes
- Harness Connectio

Dimensions and Classifications

- Overall Length (Imperial)
- 6 ft
- Overall Length (Metric)
- 1.83 m

3M™ DBI-SALA® Nano-Lok™ Hot Work Self-Retracting Lifeline with Quick Connect 3100560, Web, Aluminum Rebar Hook, 6 ft

3M Product Number 3100560 3M ID 7100325444 UPC 00648250242612

Details

Constructed with Kevlar® fiber webbing
Kevlar® protected energy absorber
Quick activating speed sensing brake system
Self-locking snap hook on the lifeline
420 lbs. (190 kg) weight capacity

Typical properties

ANSI Class Level
Class 1
Average Arrest Force (Imperial)
1125 lbf (ANSI), 1125 lbf (OSHA 130 lb - 310 lb), 1125 lbf (OSHA up to 420 lb)
Average Arrest Force (Metric)
5 kN (ANSI)
Brands
DBI-SALA®
Connected Safety ID Equipped
Yes
Harness Connectio

Dimensions and Classifications

Overall Length (Imperial)
6 ft
Overall Length (Metric)
1.83 m

3M™ DBI-SALA® Nano-Lok™ Hot Work Self-Retracting Lifeline with Quick Connect 3100558, Web, Steel Rebar Lock Hook, 6 ft

3M Product Number 3100558 3M ID 7100325443 UPC 00648250242599

Details

Constructed with Kevlar® fiber webbing
Kevlar® protected energy absorber
Quick activating speed sensing brake system
Self-locking snap hook on the lifeline
420 lbs. (190 kg) weight capacity

Typical properties

ANSI Class Level
Class 1
Average Arrest Force (Imperial)
1125 lbf (ANSI), 1125 lbf (OSHA 130 lb - 310 lb), 1125 lbf (OSHA up to 420 lb)
Average Arrest Force (Metric)
5 kN (ANSI)
Brands
DBI-SALA®
Connected Safety ID Equipped
Yes
Harness Connectio

Dimensions and Classifications

Overall Length (Imperial)
6 ft
Overall Length (Metric)
1.83 m

3M™ DBI-SALA® Lad-Saf™ Aluminum Ladder Gate with Fastener Kit 5901980

Part Number 5901980 3M Product Number 5901980 3M ID 7012819640

Details

Door constructed of heavy gauge aluminum, assembly constructed of galvanized steel

No welding, cutting or alterations needed

Effectively prevents unauthorized use

Typical properties

Brands

DBI-SALA®

Case Quantity

1

Connected Safety ID Equipped

No

Dimensions

36.00x0.13x96.00in

Product Series

Lad-Saf™

Product Type

Ladder Gate

Recommended Industry

Construction, General Industrial, Oil & Gas, Transportation, Utilities, Wind

3M™ DBI-SALA® Temporary I-Beam Horizontal Lifeline Stanchion with Base 7400057, Fits 24 - 36 in Flange Up To 2.25 in Thick

Part Number 7400057 3M Product Number 7400057 3M ID 7012820231

Details

- Fits 6 in. to 12 in. (15.2-30.5 cm) wide flange up to 2-1/4" (5.7 cm) thick
- Various lengths and individual components are available
- Equipped with RFID
- Single and multi-span indefinite length system configurations
- Pass-thru 100% tie-off protection
- Simple clamp and wing nut installation
- Flexible system capacity
- Durable, lightweight and portable construction
- Top mounted adjustment system
- Single and multi-span indefinite length system configurations

Typical properties

- Brands
 - DBI-SALA®
- Case Quantity
 - 1
- Connected Safety ID Equipped
 - Yes
- For Use With
 - 3M™ DBI-SALA® SecuraSpan™ I-Beam System
- Install Type
 - Temporary/Portable
- Lifeline Material
 - Order separately
- Maximum Number of Workers
 - 2 Per Span, 6 Total
- Net Weigh

3M™ DBI-SALA® Temporary I-Beam Horizontal Lifeline Stanchion with Base 7400055, Fits 12 - 18 in Flange Up To 2.25 in Thick

Part Number 7400055 3M Product Number 7400055 3M ID 7012820229

Details

- Fits 6 in. to 12 in. (15.2-30.5 cm) wide flange up to 2-1/4" (5.7 cm) thick
- Various lengths and individual components are available
- Equipped with RFID
- Single and multi-span indefinite length system configurations
- Pass-thru 100% tie-off protection
- Simple clamp and wing nut installation
- Flexible system capacity
- Durable, lightweight and portable construction
- Top mounted adjustment system
- Single and multi-span indefinite length system configurations

Typical properties

- Brands
 - DBI-SALA®
- Case Quantity
 - 1
- Connected Safety ID Equipped
 - Yes
- For Use With
 - 3M™ DBI-SALA® SecuraSpan™ I-Beam System
- Install Type
 - Temporary/Portable
- Lifeline Material
 - Order separately
- Maximum Number of Workers
 - 2 Per Span, 6 Total
- Net Weigh

3M™ DBI-SALA® SecuraSpan™ Perpendicular I-Beam HLL Stanchion with Base

7400087, Order Separately, 1 ea

Part Number 7400087 3M Product Number 7400087 3M ID 7100220277

Details

- Fits 6 in. to 12 in. (15.2-30.5 cm) wide flange up to 2-1/4" (5.7 cm) thick
- Various lengths and individual components are available
- Equipped with RFID
- Single and multi-span indefinite length system configurations
- Pass-thru 100% tie-off protection
- Simple clamp and wing nut installation
- Flexible system capacity
- Durable, lightweight and portable construction
- Top mounted adjustment system
- Single and multi-span indefinite length system configurations

Typical properties

- Brands
- DBI-SALA®
- Case Quantity
- 1
- Connected Safety ID Equipped
- Yes
- D-ring Placement
- Double Front
- For Use With
- 3M™ DBI-SALA® SecuraSpan™ I-Beam System
- Install Type
- Temporary/Portable
- Lifeline Material
- Order separately
- Maximum Number of Workers

3M™ DBI-SALA® Temporary I-Beam Horizontal Lifeline Stanchion with Base 7400056, Fits 18 - 24 in Flange Up To 2.25 in Thick

Part Number 7400056 3M Product Number 7400056 3M ID 7012820230

Details

- Fits 6 in. to 12 in. (15.2-30.5 cm) wide flange up to 2-1/4" (5.7 cm) thick
- Various lengths and individual components are available
- Equipped with RFID
- Single and multi-span indefinite length system configurations
- Pass-thru 100% tie-off protection
- Simple clamp and wing nut installation
- Flexible system capacity
- Durable, lightweight and portable construction
- Top mounted adjustment system
- Single and multi-span indefinite length system configurations

Typical properties

- Brands
 - DBI-SALA®
- Case Quantity
 - 1
- Connected Safety ID Equipped
 - Yes
- For Use With
 - 3M™ DBI-SALA® SecuraSpan™ I-Beam System
- Install Type
 - Temporary/Portable
- Lifeline Material
 - Order separately
- Maximum Number of Workers
 - 2 Per Span, 6 Total
- Net Weigh

3M™ Hard Hat Suspension H-700S6, 6-Point Strap, 20 EA/Case

3M Product Number H-700-S6 3M ID 7000053150 UPC 10078371654921

Details

Approved accessory for 3M™ H-700 series hard hats
Suspension strap to be used with 4-point pinlock or 4-point ratchet suspensions
Strap creates a 6-point suspension system
6-point suspension offers more comfort
Nylon strap

Typical properties

Brands
3M™
Case Quantity
20
Compatible Hard Hat
H-700, H-700T, H-800, X5000
For Use With
3M™ Headgear Systems, Hard Hats
High Heat
Yes
Material
Nylon
Product Color
Black
Product Series
H-700
Product Type
Suspension for helmets
Recommend

Dimensions and Classifications

Overall Height (Imperial)
0.25 in
Overall Height (Metric)
0.64 cm
Overall Length (Imperial)
11 in
Overall Length (Metric)
27.94 cm
Overall Width (Imperial)
5 in
Overall Width (Metric)
12.7 cm

3M™ DBI-SALA® SSB Cable Climb Assist System Fall Arrest Block Pulley Assembly 3511063, Galvanized Steel

Part Number 3511063 3M Product Number 3511063 3M ID 7100268944

Details

SSB climb assist and fall arrest block pulley assembly
Speed sensing brake stops falling climber
Unlimited length of system
Rugged and corrosion resistant construction
User installed system is fast, easy and safe
Order lifeline, mounting bracket and counterweight separately

Typical properties

Attachment Type
Bolt-On
Brands
DBI-SALA®
Case Quantity
1,1 EA/Case
Connected Safety ID Equipped
No
Dimensions
8.5 in x 8.5 in x 3.5 in
Install Type
Permanent
Maximum Number of Users
One
Net Weight (Imperial)
17 lb
Net Weight (Metric)
7.7

3M™ DBI-SALA® Portable Counterweight Pylon Anchor 7256000, with 45 lb Weights

Part Number 7256000 3M Product Number 7256000 3M ID 7100314306

Details

Portable Pylon Anchor is ideal for anchoring the 3M™ Rollgliss™ descender system

Use on a variety of surfaces for added flexibility

System does not require special tools or equipment to install

Portable design is easily moved by hand

This safety equipment is designed for use with additional personal protective equipment

Twenty individual 45 lb. (20 kg) counterweights included

Quick and easy installation

Durable and corrosion resistant construction

Typical properties

Anchor Install Type

Reusable

Attachment Type

Counterweight

Brands

DBI-SALA®

Case Quantity

1

Connected Safety ID Equipped

No

Install Type

Portable

Material

Steel

Product Color

Blue, Silver

Product Type

Portable Pylon Anchor

Recommended In

3M™ DBI-SALA® Portable Tandem Pulley Anchor 8800023, Fits 3/8 - 1/2 in Rope/Cable

3M Product Number 8800023 3M ID 7100260112 UPC 00840779005826

Details

Portable Pylon Anchor is ideal for anchoring the 3M™ Rollgliss™ descender system

Use on a variety of surfaces for added flexibility

System does not require special tools or equipment to install

Portable design is easily moved by hand

This safety equipment is designed for use with additional personal protective equipment

Twenty individual 45 lb. (20 kg) counterweights included

Quick and easy installation

Durable and corrosion resistant construction

3M™ DBI-SALA® Roof Top Anchor 2100138

Part Number 2100138 3M Product Number 2100138 3M ID 7100228424

Details

Durable materials and hardware designed to help stand up to harsh working conditions

Compatible with various fall arrest systems

Suitable for use in general industrial and construction industries

Compact, lightweight design

Meets the requirements for 29 CFR OSHA 1910.140 and 29 CFR OSHA 1926.502

Features corrosion-resistant, steel and aluminum construction for durability

This safety equipment is designed for use with additional personal protective equipment (PPE)

Installs to flat or low sloped (up to 3;12 pitch) steel steel standing seam roofs

Tie-off point swivels for complete mobility

Multi-person use with horizontal lifeline system

Typical properties

Anchor Install Type

Permanent

Attachment Type

Clamp

Brands

DBI-SALA®

Case Quantity

1

Connected Safety ID Equipped

No

Dimensions

13.80x17.30x9.00in

For Use With

Standing Seam Roofs

Install Type

Reusable

Material

Zinc Plated Steel

Product

3M™ DBI-SALA® Rollgliss™ Technical Rescue Offset D Fall Arrest Carabiner with Captive Eye, 2000117, Gold, Medium

Part Number 2000117 3M Product Number 2000117 3M ID 7100221696

Details

- User friendly compact design
- Variable width gate opening steel or aluminum carabiner
- Versatility of attachment to fall protection systems
- Corrosion-resistant
- Available in multiple sizes and shapes
- Recommended for mining, oil and gas, utilities, wind energy, and general industrial applications
- Meets the requirements of EN362 and ANSI/ASSP 359.12-2019
- High-strength steel or aluminum construction
- Durable and lightweight

Typical properties

- Brands
 - DBI-SALA®
- Case Quantity
 - 1
- CoWorker Controlled Ascent
 - No
- CoWorker Controlled Descent
 - No
- Connected Safety ID Equipped
 - No
- Dimensions
 - 108.00x70.00xmm
- Material
 - Steel
- Product Color
 - Gold
- Product Series
 - Rollgliss™
- Product Type
 - Offset D F

3M™ Protecta® Reusable Roof Anchor For Standing Seam 2190072, Fits 12 in, 24 in, 30 in, 32 in, 36 in Spacing

Part Number 2190072 3M Product Number 2190072 3M ID 7100237100

Details

Installs to flat or sloped standing seam roofs. System clamps to standing seams without special tools, providing an anchorage point for an SRL

Non-penetrating design with four seam clamps allows for quick attachment without damaging the roof

Adjustable legs with simple bolt style allow you to size the system to a variety of seam spacing. Fits 12, 24, 30, 32 and 36 in. spacing

Portable and reusable. Anchor can be removed and simply reinstalled in a new location for added jobsite flexibility

Typical properties

Brands

PROTECTA®

Case Quantity

1 EA

Connected Safety ID Equipped

No

For Use With

3M™ Protecta® Self-Retracting Lifeline (SRLs)

Material

Steel

Mounting Type

Portable & Reusable

Product Type

Standing Seam Roof Anchor - For SRL

Recommended Appl

3M™ DBI-SALA® Permanent Multi-Span Horizontal Lifeline Intermediate Bracket 7608001

Part Number 7608001 3M Product Number 7608001 3M ID 7100301367

Details

Zinc-plated steel

Intended for use in a 3M™ DBI-SALA® Permanent Multi-Span Horizontal Lifeline System

Recommended for use in multiple industries including construction, facilities, power plants, general manufacturing, heavy infrastructure, bridge building, and more

The 3M™ DBI-SALA® Permanent Multi-Span Horizontal Lifeline system is a reliable choice for safety managers

Horizontal lifeline systems offer exceptional range of fall protection anchorage on the job

This horizontal lifeline system is intended for use with a fall protection harness and lanyard or SRL

Typical properties

Brands

DBI-SALA®

Case Quantity

1

Connected Safety ID Equipped

No

Features

Intermediate Bracket

Install Type

Permanent

Lifeline Material

Order separately

Maximum Number of Workers

2

Net Weight (Imperial)

1.3 lb

Net Weight (Metric)

0.6 kg

3M™ DBI-SALA® EZ-Stop™ Spreader Hook Positioning Device 2108403, Zinc Plated Steel, 10 in

Part Number 2108403 3M Product Number 2108403 3M ID 7012818352

Details

10 in. (25 cm) steel spreader hook
Add a carabiner, and its ideal for work positioning
All metal construction
User friendly dual self-locking snap hooks

Typical properties

Brands
DBI-SALA®
Case Quantity
1
Connected Safety ID Equipped
No
Energy Absorber Class
None
Harness Connection Hook Material
Zinc Plated Steel
Harness Connection Type
Snap Hook
Lanyard Length (Imperial)
10 in
Lanyard Material
Steel
Lanyard

Dimensions and Classifications

Overall Length (Imperial)
10 in

3M™ DBI-SALA® Metal Horizontal Lifeline Energy Absorber 7401013, Stainless Steel

Part Number 7401013 3M Product Number 7401013 3M ID 7100260186

Details

Metal energy absorbers help protect the structure, and minimize needed fall clearance

Durable stainless steel materials stand up to harsh work conditions

Recommended for multiple industries including construction, general manufacturing, heavy industrial, oil and gas, transportation, and more

Single-span systems hold up to 2 workers; multi-span systems hold up to 6 workers

Compatible with galvanized and stainless steel lifeline cables

This safety equipment is intended for use with additional personal protective equipment (PPE)

Allows use of standard 5,000 lbs. (2268 kg) anchors including a tie-off adaptor, fixed beam anchor, D-ring anchorage plate and more

Configure up to 60 ft. length single span system with one device or 100 ft. single span and all multiple span systems with two Metal Energy Absorbers

Typical properties

Brands

DBI-SALA®

Case Quantity

1

Connected Safety ID Equipped

No

Install Type

Temporary/Portable

Lifeline Material

Order separately

Maximum Number of Workers

2

Net Weight (Imperial)

2.9 lb

Net Weight (Metric)

1.3 kg

Product Type

Energy Ab

3M™ Half Facepiece Reusable Respirator 7502/37082(AAD) Medium 10 EA/Case

Part Number 37082 3M Product Number 7502 3M ID 7000002162

Details

Recommended applications include abatement, painting, welding, chemical handling, construction, utilities, mining, pharmaceutical, smelting, and more
Use with 3M™ Particle Filters 2000, 2200, 7000, or 5000 Series to filter certain particulates
Use with 3M™ Gas/Vapor Cartridges 6000 Series to help filter a broad range of gases and vapors
Use with 3M™ Combination Cartridges 6000 Series to help filter particulates in addition to gases and vapors
Compatible with 3M™ TR-600 and TR-800 powered air purifying respirator and Dual Airline supplied air systems against a variety of gases, vapors, and particulate hazards
Sizes are color coded for easy identification
Drop-down feature allows the respirator to be taken off in a non-contaminated area without having to remove a hard hat
For workplace/occupational use only

Typical properties

Accessories
No
Assigned Protection Factor
10
Brands
3M™
Case Quantity
1/bag
Clip-on Welding Shield
No
Compatible With
Line Compressed Air System SA Series
Compatible with 3M™ PAPR Systems
No
Compatible with 3M™ Supplied Air System
No
Compa

3M™ DBI-SALA® Lad-Saf™ Ladder Anchor Post with Removable Extension 6116026, Galvanized Steel

Part Number 6116026 3M Product Number 6116026 3M ID 7100250926

Details

Removable ladder anchor post for fixed ladders
Ideal for covered ladders such as manhole applications
Built-in eye-bolt is offset to attach 3-way SRL

Typical properties

Attachment Type
Slides Into 6116027 Bolt-On Bracket
Brands
DBI-SALA®
Case Quantity
1
Connected Safety ID Equipped
No
Dimensions
7.5 in x 2.8 in x 94.5 in
Install Type
Temporary
Maximum Number of Users
One
Net Weight (Imperial)
49 lb
Net We

3M™ DBI-SALA® Roofer's Fall Protection Kit 2104168

3M Product Number 2104168 3M ID 7100228429 UPC 00840779000678

Details

Lightweight and portable
Contents of kits are conveniently stored inside the packaging
Easily transportable from one site to another

Typical properties

Anchor Attachment Type
Nail/Screw
Anchor Install Type
Reusable
Brands
DBI-SALA®
Case Quantity
1
Connected Safety ID Equipped
Yes
Dimensions
(15.50x7.50x6.50)in
For Use With
Heavy-duty Anchor
Kit Type
Roofer's Kit
Kits & Systems
Kit
Lanya

3M™ DBI-SALA® Roofers Fall Protection Compliance Kit 2104169, Anchor, Harness, Rope Grab/Lanyard, Lifeline, 50 ft

3M Product Number 2104169 3M ID 7012818307 UPC 00840779111701

Details

Lightweight and portable
Contents of kits are conveniently stored inside the packaging
Easily transportable from one site to another

Typical properties

Anchor Attachment Type
Nail
Anchor Install Type
Reusable
Brands
DBI-SALA®
Case Quantity
1
Connected Safety ID Equipped
Yes
Dimensions
15.50x7.50x6.50in
For Use With
Hinged Anchor
Kit Type
Roofer's Kit
Kits & Systems
Kit
Lanyard Length (l

3M™ DBI-SALA® Nano-Lok™ Connected Order Picker Self-Retracting Lifeline Kit 3100268, Electronic Box, Mounting Kit, 6 ft

3M Product Number 3100268 3M ID 7012818443

Details

Fall Protection system provides audible and visual alert of worker tie off status
Detects associate's presence as they move on and off order picker platform
Works with all metallic OSHA rated dorsal D-ring's
Non disruptive and encourages safe connection and situational awareness
Lightweight aluminum snap hook with plastic cover
A modular system designed for replacement parts that can be ordered separately and installed easily
11' (3.4 m) Dynema™ fiber and polyester web lifeline

Typical properties

Anchor Connection Type
Cab-mount Bracket
Anchor Hook Material
Aluminum
Brands
DBI-SALA®
Connected Safety ID Equipped
Yes
Harness Connection Type
Connected Carabiner
Housing Material
Nylon Thermoplastic
Install Type
Reusable or Permanent
Life

3M™ DBI-SALA® Lad-Saf™ Cable Vertical Safety System Bracketry, Climb Extension 6116636, 2 User, Galvanized Steel

Part Number 6116636 3M Product Number 6116636 3M ID 7100227918

Details

Designed to meet the requirements of the ANSI Z359.16 standard, along with OSHA 1910.140 and 1926.502, when used with our Lad-Saf X3 Detachable Cable Sleeve (6160054) and Lad-Saf X2 Detachable Cable Sleeve (6160030)
Reengineered to simplify and speed up the installation process
Flexible: Mounting brackets can be used on a variety of fixed ladder styles that may consist of different rung spacings and shapes
Light – weighs less than previous 3M systems

Typical properties

Brands
DBI-SALA®
Case Quantity
1
Connected Safety ID Equipped
Yes
Install Type
Permanent
Product Color
Silver
Product Series
Lad-Saf™
Product Type
Vertical Safety System Bracketry
Recommended Application
Ladder Climbing
Recommended Industr

3M™ DBI-SALA® Reusable Swiveling Roof Anchor For Wood/Metal 2190071, with Fastener Kit

Part Number 2190071 3M Product Number 2190071 3M ID 7012779168

Details

Durable materials and hardware designed to help stand up to harsh working conditions
Compatible with various fall arrest systems, not compliant for use with Horizontal Lifelines
Suitable for use in general industrial and construction industries
Compact, lightweight design
Meets the requirements for 29 CFR OSHA 1910.140 and 29 CFR OSHA 1926.502
Features corrosion-resistant, steel and aluminum construction for durability
This safety equipment is designed for use with additional personal protective equipment (PPE)
Built-in swiveling self retracting lifeline bracket (order SRL separately)
This safety equipment is designed for use with additional personal protective equipment
Low-profile design stays out of the way as you work

Typical properties

Anchor Hook Material
Metal
Anchor Install Type
Reusable
Brands
DBI-SALA®
Case Quantity
1 EA
Connected Safety ID Equipped
No
For Use With
3M™ DBI-SALA® Smart Lock Self-Retracting Lifeline (SRL)
Housing Material
Steel Only
Housing Type
Stainl

Dimensions and Classifications

Overall Length (Imperial)
16.5 in

3M™ DBI-SALA® Lad-Saf™ Cable Vertical Safety System Bracketry 6116633, 4 User, Galvanized Steel

Part Number 6116633 3M Product Number 6116633 3M ID 7100237754

Details

Designed to meet the requirements of the ANSI Z359.16 standard, along with OSHA 1910.140 and 1926.502, when used with our Lad-Saf X3 Detachable Cable Sleeve (6160054) and Lad-Saf X2 Detachable Cable Sleeve (6160030)
Reengineered to simplify and speed up the installation process
Flexible: Mounting brackets can be used on a variety of fixed ladder styles that may consist of different rung spacings and shapes
Light – weighs less than previous 3M systems

Typical properties

Brands
DBI-SALA®
Case Quantity
1
Connected Safety ID Equipped
Yes
Install Type
Permanent
Product Color
Silver
Product Series
Lad-Saf™
Product Type
Vertical Safety System Bracketry
Recommended Application
Billboard Maintenance, Grain Bin Mai

3M™ DBI-SALA® Lad-Saf™ Cable Vertical Safety System Bracketry 6116632, 2 User, Stainless Steel

Part Number 6116632 3M Product Number 6116632 3M ID 7100237753

Details

Designed to meet the requirements of the ANSI Z359.16 standard, along with OSHA 1910.140 and 1926.502, when used with our Lad-Saf X3 Detachable Cable Sleeve (6160054) and Lad-Saf X2 Detachable Cable Sleeve (6160030)
Reengineered to simplify and speed up the installation process
Flexible: Mounting brackets can be used on a variety of fixed ladder styles that may consist of different rung spacings and shapes
Light – weighs less than previous 3M systems

Typical properties

Brands
DBI-SALA®
Case Quantity
1
Connected Safety ID Equipped
Yes
Install Type
Permanent
Product Color
Silver
Product Series
Lad-Saf™
Product Type
Vertical Safety System Bracketry
Recommended Application
Billboard Maintenance, Grain Bin Mai

3M™ DBI-SALA® Lad-Saf™ Cable Vertical Safety System Bracketry 6116631, 2 User, Galvanized Steel

Part Number 6116631 3M Product Number 6116631 3M ID 7100237572

Details

Designed to meet the requirements of the ANSI Z359.16 standard, along with OSHA 1910.140 and 1926.502, when used with our Lad-Saf X3 Detachable Cable Sleeve (6160054) and Lad-Saf X2 Detachable Cable Sleeve (6160030)
Reengineered to simplify and speed up the installation process
Flexible: Mounting brackets can be used on a variety of fixed ladder styles that may consist of different rung spacings and shapes
Light – weighs less than previous 3M systems

Typical properties

Brands
DBI-SALA®
Case Quantity
1
Connected Safety ID Equipped
Yes
Install Type
Permanent
Product Color
Silver
Product Series
Lad-Saf™
Product Type
Vertical Safety System Bracketry
Recommended Application
Billboard Maintenance, Grain Bin Mai

3M™ Secure Click™ Organic Vapor/Acid Gas Cartridge D8003, 60 ea/Case

3M Product Number D8003 3M ID 7100153220 UPC 00051131374676

Details

Secure Click™ connection style enables a quick, simple connection of cartridges
Secure Click™ cartridges are dual-flow to allow easy breathing and greater comfort

Use with NIOSH-approved 3M™ Secure Click™ Facepieces

NIOSH-approved for protection against certain organic vapors, chlorine, hydrogen chloride/sulfur dioxide, or chlorine dioxide or hydrogen sulfide

Swept-back design for enhanced field of view and comfort

For workplace/occupational use only

Package contents: 1 case contains 30 pairs of filters (60 each)

Typical properties

Accessories

No

Brands

Secure Click™

Cartridge or Filter Type

Gas & Vapor

Clip-on Welding Shield

No

Compatible Respirator

3M™ Secure Click™ Half Facepiece Reusable Respirators HF-800 Series

Compatible with 3M™ PAPR Systems

No

Compatible with 3M

Dimensions and Classifications

Overall Height (Metric)

34 mm

Overall Length (Metric)

105 mm

Overall Width (Metric)

89 mm

3M™ 1100 Probed Test Earplugs 393-2010-50, 10 Pair/Bag, 5 Bags/Case, 50 Pair/Case

3M Product Number 393-2010-50 3M ID 7000002409 UPC 10080529190878

Details

These test earplugs are modified with a probe tube for use during earplug fit testing with the 3M™ E-A-Rfit™ Validation System

50 PR Per Case

3M PSD products are for occupational use only

*The NRR may overestimate the hearing protection provided during typical use

Typical properties

Brands

3M™

Case Quantity

50

Earplug Shape

Tapered

Material

Polyurethane

Product Color

Orange

Product Series

E-A-Rfit

Product Type

Probed Test Earplug

Recommended Application

Health & Safety Testing

eClass 14 Classification Group

40270102

3M™ Versaflo™ M-Series Inner Collar M-444, for use with all M-Series Outer Shrouds, 1 EA/Case

3M Product Number M-444 3M ID 7000127683 UPC 00051131173255

Details

Required part of a M-400 system

Typical properties

Brands

Versaflo™

Case Quantity

1

Compatible With

3M™ Versaflo™ M-407 Helmet

Headgear Type

Helmet with Faceshield

High Heat

No

Material

Polyurethane Coated Knitted Polyamide Fabric

Product Color

Black

Product Series

M-Series

Product Type

I

3M™ DBI-SALA® Rescue/Retrieval Web Loop Wristlets 1001210, 2 ft

Part Number 1001210 3M Product Number 1001210 3M ID 7012815084

Details

- Retrieval wistlets for confined space rescue
- Attaches to victims wrists
- Ideal for narrow extractions
- Integral D-ring connection point for winch/SRL
- Durable polyester construction
- Compact and lightweight design

Typical properties

- Brands
DBI-SALA®
- For Use With
Confined Space Rescue
- Harness Connection Type
None
- Lanyard Length (Imperial)
2 ft
- Lanyard Material
Polyester
- Weight Capacity (Imperial)
310 lb.
- Weight Capacity (Metric)
141 kg

3M™ Adflo™ Powered Air Purifying Respirator Suspenders, 15-0099-17, 1 EA/Case

3M Product Number 15-0099-17 3M ID 7100215094 UPC 00076308944940

Details

For maximum safety and comfort, make it a habit to check your equipment regularly

Replace worn out or damaged parts

Typical properties

Brands

Adflo™

Compatible Welding Helmet

G5-01 Welding Helmets

Product Color

Black

Product Series

G5

Product Type

Suspenders

Recommended Application

Grinding, Metal Processing, Metal Repair, Welding

Recommended Industry

General Manufacturing,

3M™ Speedglas™ G5-02 Curved Auto Darkening Filter 08-0000-50iC, 1 ea/Case

Part Number 08-0000-50iC 3M Product Number 08-0000-50iC 3M ID 7100243649

Details

Our largest ADF field of view ever (150x76 mm), utilizing the 3M™ Speedglas™ Curved Glass Technology
Great clarity before, during and after welding, with our 3M™ Speedglas™ Natural Colour Technology
By selecting just the right settings for each task, you help reduce eye strain and can improve the quality of every weld
The sensitivity of arc detection can be adjusted for unsurpassed switching reliability
Delay function to set the dark-to-light opening time
Bluetooth enabled: with the 3M Connected Equipment app, users get access to additional functionalities, statistics and documentation

Typical properties

Brands
Speedglas™
Case Quantity
1/Case
Compatible Welding Helmet
G5-02 Welding Helmets
For Use With
G5-02 Welding Helmets
Product Series
G5
Product Type
Auto-darkening Filter
Recommended Application
Welding
Recommended Industry
Construction

3M™ DBI-SALA® Rope Tagline 7211858, 3/16 in Polypropylene, 35 ft

Part Number 7211858 3M Product Number 7211858 3M ID 7100263248

Details

Tagline for self retracting lifeline
35 ft. (10.7 m) 3/16" (5 mm) polypropylene rope
Attached steel O-ring
Durable materials
Compact and lightweight design

Typical properties

Brands
DBI-SALA®
Case Quantity
1
Connected Safety ID Equipped
No
Material
Polypropylene
Product Type
Tagline for Self Retracting Lifeline
Recommended Industry
Construction, General Industrial, Oil & Gas, Transportation, Utilities, Wind Energy

Dimensions and Classifications

Overall Length (Imperial)
35 ft

3M™ Double Locking Snap Hook 9502116, Zinc Plated Steel, 3600 lb Gate, 0.75 in Throat

Part Number 9502116 3M Product Number 9502116 3M ID 7100310338

Details

Corrosion resistant plated steel hardware
High strength construction with 3,600 lb (16kN) rated gate
Double action and locking gate for added safety
Compact design
Designed to allow horizontal movement along the anchorage, but does not include capability to pass intersecting structures
Compatible with various fall arrest systems
Recommended for use in multiple industries including construction, oil and gas, and utilities
Meets the requirements for 29 CFR OSHA 1910.140, 29 CFR OSHA 1926.502

Typical properties

Attachment Type
Hook, None
Brands
Advanced™
Carabiner/Hook Material
Zinc Plated Steel
Case Quantity
1
Connected Safety ID Equipped
No
Dimensions
110.00x73.00xmm
Install Type
None, Reusable
Product Type
Double action snap hook
Recommended I

3M™ DBI-SALA® Metal Horizontal Lifeline Energy Absorber with Hardware Kit 7401032, 2 Shackles, Turnbuckle

Part Number 7401032 3M Product Number 7401032 3M ID 7012820256

Details

For use with horizontal lifeline system
Metal energy absorber limits fall arrest forces
Durable, lightweight and portable design
Configure up to 60 ft. (18.3m) length system with one device or 100 ft. (30.5m) with two
Lightweight and portable design
Extremely durable construction
Mounting kit includes 3 shackles and fasteners

Typical properties

Brands
DBI-SALA®
Case Quantity
1
Connected Safety ID Equipped
No
Install Type
Temporary/Portable
Lifeline Material
Order separately
Maximum Number of Workers
2
Recommended Industry
Construction, General Industrial, Oil & Gas, Transportation

3M™ DBI-SALA® Metal Horizontal Lifeline Energy Absorber with Hardware Kit 7600580, 3 Shackles, Turnbuckle, Cable Clips, Wedge Grip

Part Number 7600580 3M Product Number 7600580 3M ID 7100314308

Details

For use with horizontal lifeline system
Metal energy absorber limits fall arrest forces
Durable, lightweight and portable design
Configure up to 60 ft. (18.3m) length system with one device or 100 ft. (30.5m) with two
Lightweight and portable design
Extremely durable construction
Mounting kit includes 3 shackles and fasteners

Typical properties

Brands
DBI-SALA®
Case Quantity
1,1 EA/Case
Connected Safety ID Equipped
No
For Use With
Temporary HLL systems
Install Type
Temporary/Portable
Lifeline Material
Order separately
Material
Aluminum
Maximum Number of Workers
2
Net Weight (Metr

3M™ PELTOR™ Hygiene Kit for FM Radio, ProTac, & LiteCom Headsets, HY79

3M Product Number HY79 3M ID 7100063118 UPC 07318640011779

Details

Replacement ear cushions, foam liners and rings

1 pair

For use on a wide variety of 3M™ Peltor™ Headsets

Replace at least twice a year to ensure constant attenuation, hygiene and comfort

Typical properties

Brands

PELTOR™

Case Quantity

1

Compatible Earmuff

FM Radio, LiteCom, ProTac

Hearing Protection Style

Hygiene Kit

Product Color

Black

Product Type

Hygiene Kit

eClass 14 Classification Group

40270191

3M™ DBI-SALA® Flexiguard™ Counterweight Base Hoist Ring Kit 8530914, 5000 lb, 4 ea/Pack

3M Product Number 8530914 3M ID 7100314341

Details

Enables system counterweight box to be moved with overhead lifting equipment
Designed to enable system transport
Helps maximize usage in various locations

Typical properties

Brands
DBI-SALA®
Connected Safety ID Equipped
No
Install Type
Temporary/Portable
Manufacturing Origin
USA
Maximum Height (Imperial)
6.36 in
Maximum Height (Metric)
16.15 cm
Minimum Height (Imperial)
6.36 in
Minimum Height (Metric)
16.15 cm

Dimensions and Classifications

Overall Height (Metric)
0 mm
Overall Length (Metric)
0 mm
Overall Width (Metric)
0 mm

3M™ Protecta® Mobile Rope Grab 5000003, Fits 5/8 in Rope

Part Number 5000003 3M Product Number 5000003 3M ID 7012819598

Details

Mobile design follows user

Inertia and cam locking systems for safety

Energy absorbing design reduces forces

For use with 5/8" (16 mm) diameter polyester/polypropylene blend rope lifeline

Detachable anywhere along the lifeline

Durable and lightweight corrosion resistant construction

Typical properties

Attachment Type

None

Brands

PROTECTA®

Case Quantity

1

Connected Safety ID Equipped

No

Dimensions

6.40x2.70x4.60in

Install Type

Temporary

Maximum Number of Users

One

Product Series

PRO™

Product Type

Mobile Rope Grab

Recommended Industry

3M™ DBI-SALA® Ultra-Lok™ RSQ Self-Retracting Lifeline 3503889, Stainless Steel Cable, 50 ft

3M Product Number 3503889 3M ID 7012819276 UPC 00648250241394

Details

- Durable aluminum or thermoplastic housing
- Available in multiple configurations, lifeline lengths, and material types
- Fall arrest energy dissipation system
- Quick activating speed-sensing locking system
- Swiveling anchorage connector loop
- Swiveling self-locking snap hook with impact indicator
- RFID Information tag embedded in polyurethane bumper
- Emergency retrieval system available on some models

Typical properties

- Anchor Connection Type
 - Carabiner
- Anchor Hook Material
 - Stainless Steel
- Anchor Hook Material
 - Stainless Steel
- Average Arrest Force (Imperial)
 - 900 lbf (OSHA 130 lb - 310 lb)
- Average Arrest Force (Metric)
 - 4 kN (OSHA 130 lb - 310 lb)
- Brands
 - DBI-SALA®

3M™ DBI-SALA® Ultra-Lok™ RSQ Self-Retracting Lifeline 3503888, Galvanized Cable, 50 ft

3M Product Number 3503888 3M ID 7012819275 UPC 00648250241387

Details

- Durable aluminum or thermoplastic housing
- Available in multiple configurations, lifeline lengths, and material types
- Fall arrest energy dissipation system
- Quick activating speed-sensing locking system
- Swiveling anchorage connector loop
- Swiveling self-locking snap hook with impact indicator
- RFID Information tag embedded in polyurethane bumper
- Emergency retrieval system available on some models

Typical properties

- Anchor Connection Type
 - Carabiner
- Anchor Hook Material
 - Zinc Plated Steel
- Anchor Hook Material
 - Zinc Plated Steel
- Average Arrest Force (Imperial)
 - 900 lbf (OSHA 130 lb - 310 lb)
- Average Arrest Force (Metric)
 - 4 kN (OSHA 130 lb - 310 lb)
- Brands
 - DBI-S

3M™ DBI-SALA® Comfort Shoulder/Back Pad For Harness 9501207, Universal

Part Number 9501207 3M Product Number 9501207 3M ID 7012821172

Details

Shoulder, back, and leg padding accessories available for enhanced worker comfort

Retrofittable comfort padding designs

Comfort padding designed to enable easy removal or replacement

Typical properties

Brands

DBI-SALA®

Case Quantity

1

Connected Safety ID Equipped

No

Dimensions

0.00x432.00xmm

For Use With

Harnesses

Material

Nylon/PVC/Lycra

Product Color

Black, Yellow

Product Series

Delta™

Product Type

Comfort Pad

Recommended Industry

C

3M™ DBI-SALA® Comfort Shoulder Pad For Harness 9502006, Hook and Loop

Part Number 9502006 3M Product Number 9502006 3M ID 7010595610

Details

Shoulder, back, and leg padding accessories available for enhanced worker comfort

Retrofittable comfort padding designs

Comfort padding designed to enable easy removal or replacement

Typical properties

Brands

DBI-SALA®

Case Quantity

1

Connected Safety ID Equipped

No

For Use With

Harnesses

Material

Nylon/Polyurethane

Net Weight (Imperial)

0.05 lb

Net Weight (Metric)

0.02 kg

Product Color

Black

Product Type

Shoulder Pad for Harness

Recom

3M™ Speedglas™ G5 Series Standard Head Rest 46-0400-53, 1/Bag

Part Number 46-0400-53 3M Product Number 46-0400-53 3M ID 7100241171

Details

Replacement part for 3M™ Speedglas™ G5 Series Welding Helmets
Designed to be swapped out if the original part becomes damaged or worn from use

For maximum safety and comfort, it is recommended to check your equipment regularly

Typical properties

Brands
Speedglas™
Compatible Welding Helmet
G5 Series Welding Helmets
Product Series
G5
Product Type
Head Rest
eClass 14 Classification Group
40300190

3M™ Speedglas™ G5-01 Large Comfort Head Rest, 46-0400-55, 1 EA/Case

3M Product Number 46-0400-55 3M ID 7100215553 UPC 00076308944711

Details

The large head rest is a consumable spare part replacing only the head rest of the headband if the original part becomes worn or damaged during use
For maximum safety and comfort, make it a habit to check your equipment regularly
Replace worn out or damaged parts

Typical properties

Brands
Speedglas™
Compatible Welding Helmet
G5-01 Welding Helmets
Product Color
Black
Product Series
G5
Product Type
Head Rest
Recommended Application
Grinding, Metal Processing, Metal Repair, Welding
Recommended Industry
General Manufacturin

3M™ PELTOR™ CH-3 Headset with PTT MT74H52P3E-111, Hard Hat Attached, FLX2, 1 ea/Case

3M Product Number MT74H52P3E-111 3M ID 7100203150 UPC 04054596695757

Details

Protective communication solution for hands-free, clear communication in noisy environments
FLX2 connection jack for easy and reliable connection to a wide assortment of handheld devices
Lasting comfort for long duration wear times
Designed to withstand harsh environmental elements
Water and dust-proof noise-cancelling microphone (IP68) for clear speech transmission in noisy and harsh environments
Audio speakers are optimized for speech frequencies and meet the efficiency demands of many of today's digital devices
A Push-To-Talk button is conveniently located on the earcup for easy access
Bright yellow color for enhanced visibility
Flexible yet sturdy hard hat attachment design adapts to a wide variety of head shapes and sizes, and fits most slotted hard hats

Typical properties

Attenuation Rating
24 dB
Audio Type
Communication
Auxiliary Port
FLX2
Brands
PELTOR™
CSA Class
CSA Class A
Case Quantity
1
Communication Direction
Two-way
Communication Type
External Audio Input
Communication via External 2-Way Radio
Yes

3M™ PELTOR™ CH-3 Headset with PTT Headband MT74H52A-111, FLX2, 10 ea/Case

3M Product Number MT74H52A-111 3M ID 7100203638 UPC 04054596695672

Details

Protective communication solution for hands-free, clear communication in noisy environments
FLX2 connection jack for easy and reliable connection to a wide assortment of handheld devices
Lasting comfort for long duration wear times
Designed to withstand harsh environmental elements
Water and dust-proof noise-cancelling microphone (IP68) for clear speech transmission in noisy and harsh environments
Audio speakers are optimized for speech frequencies and meet the efficiency demands of many of today's digital devices
A Push-To-Talk button is conveniently located on the earcup for easy access
Bright yellow color for enhanced visibility
Flexible yet sturdy headband design adapts to a wide variety of head shapes and sizes

Typical properties

Attenuation Rating
26 dB
Audio Type
Communication
Auxiliary Port
FLX2
Brands
PELTOR™
CSA Class
CSA Class A
Case Quantity
1
Communication Direction
Two-way
Communication Type
External Audio Input
Communication via External 2-Way Radio
Yes

3M™ Particulate Filter 5N11, N95 100 EA/Case

Part Number 46464 3M Product Number 5N11 3M ID 7000002008

Typical properties

Accessories

Yes

Aerosol Type

Non-Oil

Brands

3M™

Cartridge or Filter Type

Particulate

Case Quantity

100/case

Clip-on Welding Shield

Yes

Compatible Respirator

3M™ Full Facepieces 6000, 3M™ Full Facepieces 7800 Series, 3M™ Full Facepieces FF-400

Dimensions and Classifications

Overall Height (Imperial)

3.4 in

Overall Length (Imperial)

4.2 in

3M™ Particulate Filter 5P71/07194(AAD), P95 100 EA/Case

Part Number 07194 3M Product Number 5P71 3M ID 7000002054

Typical properties

Accessories
Yes
Aerosol Type
Oil and Non-Oil
Braided Comfort Strap
No
Brands
3M™
Cartridge or Filter Included
Yes
Cartridge or Filter Type
Particulate
Case Quantity
100/case
Clip-on Welding Shield
Yes
Compatible Respirator
3M™ Full Facepi

Dimensions and Classifications

Overall Height (Imperial)
3.4 in
Overall Length (Imperial)
4.2 in

3M™ Secure Click™ Particulate Filter P95 D3071, 100 EA/Case

3M Product Number D3071 3M ID 7100213358 UPC 50051131278115

Details

CE approved for environments containing particulates

Hear it: Quick, simple cartridge connection. Simply align the connections and push until you hear a click. Use with CE approved 3M™ Secure Click™

Facepieces

Feel it: Dual-flow filters allow for easy breathing

Swept back filter design for compatibility with certain welding and grinding shields

NIOSH-approved P95 particulate filter for respiratory protection against certain oil and non-oil based particulates

Swept-back design for enhanced field of view

For workplace/occupational use only

Package contents: 1 case contains 50 pairs of filters (100 each)

Typical properties

Accessories

No

Brands

Secure Click™

Cartridge or Filter Type

Particulate

Clip-on Welding Shield

No

Compatible Respirator

3M™ Secure Click™ Half Facepiece Reusable Respirators HF-800 Series

Compatible with 3M™ PAPR Systems

No

Compatible with 3M

Dimensions and Classifications

Overall Height (Metric)

25 mm

Overall Length (Metric)

120 mm

Overall Width (Metric)

105 mm

3M™ Secure Click™ Hard Case P100 Particulate Filter D9093, 60 ea/Case

3M Product Number D9093 3M ID 7100206894 UPC 50689330191562

Details

CE approved for environments containing particulates

Hear it: Quick, simple cartridge connection. Simply align the connections and push until you hear a click. Use with CE approved 3M™ Secure Click™

Facepieces

Feel it: Dual-flow filters allow for easy breathing

Swept back filter design for compatibility with certain welding and grinding shields

Filter case designed for certain spray applications

Secure Click™ connection allows filters to be inserted into place for ease of assembly

Solid top and channeled airflow help protect filter

Swept-back design provides wide field of view

Typical properties

Accessories

No

Brands

Secure Click™

Cartridge or Filter Type

Particulate

Compatible Respirator

3M™ Secure Click™ Half Facepiece Reusable Respirators HF-800 Series

Compatible with 3M™ PAPR Systems

No

Compatible with 3M™ Supplied Air System

No

C

3M™ Secure Click™ Hard Case P100 Particulate Filter D9093C, Hydrogen Fluoride and Nuis. Level OV/AG Relief, 60 ea/Case

3M Product Number D9093C 3M ID 7100206890 UPC 50689330191579

Details

- 99.97% filter efficiency meets NIOSH P100 test criteria
- Use with 3M™ Secure Click™ Respirators
- Hard case recommended for harsh environments with a need for easy decontamination and protection
- Hard case helps protect against sparks and high heat
- Filter case designed for certain spray applications
- Secure Click™ connection allows filters to be inserted into place for ease of assembly
- Solid top and channeled airflow help protect filter
- Swept-back design provides wide field of view
- Nuisance odor relief for organic vapors and acid gas levels below the OSHA Permissible Exposure Level (PEL)

Typical properties

- Accessories
No
- Brands
Secure Click™
- Cartridge or Filter Type
Combination
- Compatible Respirator
3M™ Secure Click™ Half Facepiece Reusable Respirators HF-800 Series
- Compatible with 3M™ PAPR Systems
No
- Compatible with 3M™ Supplied Air System
No
- C

3M™ Secure Click™ Particulate Filter P100 with Nuisance Level Organic Vapor Relief D3097, 100 ea/Case

3M Product Number D3097 3M ID 7100213150 UPC 50051131278160

Details

Secure Click™ connection style enables a quick, simple connection of filters
Secure Click™ filters are dual-flow to allow easier breathing and greater comfort
Use with NIOSH-approved 3M™ Secure Click™ facepieces
Advanced Electret Media (AEM) provides lightweight, easy breathing comfort
NIOSH-approved P100 particulate filter for respiratory protection against certain oil and non-oil based particulates
Recommended for ozone protection up to 10x the OSHA PEL
Nuisance level organic vapor relief
Swept-back design for enhanced field of view and comfort
For workplace/occupational use only
Package contents: 1 case contains 50 pairs of filters (100 each)

Typical properties

Accessories

No

Brands

Secure Click™

Cartridge or Filter Type

Particulate

Clip-on Welding Shield

No

Compatible Respirator

3M™ Secure Click™ Half Facepiece Reusable Respirators HF-800 Series

Compatible with 3M™ PAPR Systems

No

Compatible with 3M

Dimensions and Classifications

Overall Height (Metric)

25 mm

Overall Length (Metric)

120 mm

Overall Width (Metric)

105 mm

3M™ Secure Click™ Particulate Filter P100 D3091, 100 EA/Case

3M Product Number D3091 3M ID 7100213359 UPC 50051131278146

Details

CE approved for environments containing particulates

Hear it: Quick, simple cartridge connection. Simply align the connections and push until you hear a click. Use with CE approved 3M™ Secure Click™

Facepieces

Feel it: Dual-flow filters allow for easy breathing

Swept back filter design for compatibility with certain welding and grinding shields

NIOSH-approved P100 particulate filter for respiratory protection against certain oil and non-oil based particulates

Swept-back design for enhanced field of view and comfort

For workplace/occupational use only

Package contents: 1 case contains 50 pairs of filters (100 each)

Typical properties

Accessories

No

Brands

Secure Click™

Cartridge or Filter Type

Particulate

Clip-on Welding Shield

No

Compatible Respirator

3M™ Secure Click™ Half Facepiece Reusable Respirators HF-800 Series

Compatible with 3M™ PAPR Systems

No

Compatible with 3M

Dimensions and Classifications

Overall Height (Metric)

25 mm

Overall Length (Metric)

120 mm

Overall Width (Metric)

105 mm

3M™ Secure Click™ Particulate Filter P100 with Nuisance Level Acid Gas Relief D3096, 100 ea/Case

3M Product Number D3096 3M ID 7100213425 UPC 50051131278153

Details

CE approved for environments containing particulates
Hear it: Quick, simple cartridge connection. Simply align the connections and push until you hear a click. Use with CE approved 3M™ Secure Click™ Facepieces
Feel it: Dual-flow filters allow for easy breathing
Swept back filter design for compatibility with certain welding and grinding shields
NIOSH-approved P100 particulate filter for respiratory protection against certain oil and non-oil based particulates
Nuisance level acid gas relief
Swept-back design for enhanced field of view and comfort
For workplace/occupational use only
Package contents: 1 case contains 50 pairs of filters (100 each)

Typical properties

Accessories
No
Brands
Secure Click™
Cartridge or Filter Type
Particulate
Clip-on Welding Shield
No
Compatible Respirator
3M™ Secure Click™ Half Facepiece Reusable Respirators HF-800 Series
Compatible with 3M™ PAPR Systems
No
Compatible with 3M

Dimensions and Classifications

Overall Height (Metric)
25 mm
Overall Length (Metric)
120 mm
Overall Width (Metric)
105 mm

3M™ PROTECTA® Rope Lifeline 5/8 in. (1.6 cm) Nylon with Carabiner AC215A1, 15M

3M ID 7100188815 UPC 00648250030950

Details

Mobile and versatile system
Manual application
Includes Carabiner

Typical properties

Lifeline Diameter (Imperial)
0.625 in
Lifeline Diameter (Metric)
1.6 cm
Lifeline Length (Imperial)
16.4 Linear Yard
Lifeline Length (Metric)
15 m
Lifeline Material
Nylon Core/Polyester Cover

3M™ DBI-SALA® EZ-Stop™ Arc Flash Stretch Web Shock-Absorbing Lanyard 1246524, Kevlar® Fiber, 6 ft

3M Product Number 1246524 3M ID 7012817315

Details

- Stretches in reaction to users movements
- Energy absorbing design limits fall arrest forces
- Abrasion-resistant webbing
- Available in a wide range of web styles and designs
- Built-in impact indicator
- Protected labels equipped with 3M™ Connected Safety ID (CSID)
- Ideal for the following applications: Construction, General Industrial, Mining, Oil & Gas, Transportation, Utilities, and Wind Energy

Typical properties

- Anchor Connection Type
 - Rebar Hook
- Anchor Hook Material
 - Zinc Plated Steel
- Brands
 - DBI-SALA®
- Case Quantity
 - 1
- Connected Safety ID Equipped
 - Yes
- Energy Absorber Class
 - 6 ft (1.8 m) Free Fall/MAAF 900 lbs. (4 kN)
- Harness Connection Hook Material
 - Zinc

Dimensions and Classifications

- Overall Length (Imperial)
 - 6 ft
- Overall Length (Metric)
 - 1.83 m

3M™ DBI-SALA® EZ-Stop™ Arc Flash Web Loop Stretch Web Shock-Absorbing Lanyard 1246519, Kevlar® Fiber, 6 ft

3M Product Number 1246519 3M ID 7012817312

Details

Stretches in reaction to users movements
Energy absorbing design limits fall arrest forces
Abrasion-resistant webbing
Available in a wide range of web styles and designs
Built-in impact indicator
Protected labels equipped with 3M™ Connected Safety ID (CSID)
Ideal for the following applications: Construction, General Industrial, Mining, Oil & Gas, Transportation, Utilities, and Wind Energy

Typical properties

Anchor Connection Type
Snap Hook
Anchor Hook Material
Zinc Plated Steel
Brands
DBI-SALA®
Case Quantity
1
Connected Safety ID Equipped
Yes
Energy Absorber Class
6 ft (1.8 m) Free Fall/MAAF 900 lbs. (4 kN)
Harness Connection Hook Material
Nomex

Dimensions and Classifications

Overall Length (Imperial)
6 ft
Overall Length (Metric)
1.83 m

3M™ DBI-SALA® EZ-Stop™ Arc Flash 100% Tie-Off Stretch Web Shock-Absorbing Lanyard 1246530, Kevlar® Fiber, 6 ft

3M Product Number 1246530 3M ID 7012817323

Details

Stretches in reaction to users movements
Energy absorbing design limits fall arrest forces
Abrasion-resistant webbing
Available in a wide range of web styles and designs
Built-in impact indicator
Protected labels equipped with 3M™ Connected Safety ID (CSID)
Ideal for the following applications: Construction, General Industrial, Mining, Oil & Gas, Transportation, Utilities, and Wind Energy

Typical properties

Anchor Connection Type
Rebar Hook
Anchor Hook Material
Aluminum
Brands
DBI-SALA®
Case Quantity
1
Connected Safety ID Equipped
Yes
Energy Absorber Class
6 ft (1.8 m) Free Fall/MAAF 900 lbs. (4 kN)
Harness Connection Hook Material
Nomex®/Kevlar

Dimensions and Classifications

Overall Length (Imperial)
6 ft
Overall Length (Metric)
1.83 m

3M™ DBI-SALA® EZ-Stop™ Arc Flash 100% Tie-Off Web Loop Stretch Web Shock-Absorbing Lanyard 1246529, Kevlar® Fiber, 6 ft

3M Product Number 1246529 3M ID 7012817321

Details

Stretches in reaction to users movements
Energy absorbing design limits fall arrest forces
Abrasion-resistant webbing
Available in a wide range of web styles and designs
Built-in impact indicator
Protected labels equipped with 3M™ Connected Safety ID (CSID)
Ideal for the following applications: Construction, General Industrial, Mining, Oil & Gas, Transportation, Utilities, and Wind Energy

Typical properties

Anchor Connection Type
Rebar Hook
Anchor Hook Material
Zinc Plated Steel
Brands
DBI-SALA®
Case Quantity
1
Connected Safety ID Equipped
Yes
Energy Absorber Class
6 ft (1.8 m) Free Fall/MAAF 900 lbs. (4 kN)
Harness Connection Hook Material
None

Dimensions and Classifications

Overall Length (Imperial)
6 ft
Overall Length (Metric)
1.83 m

3M™ DBI-SALA® EZ-Stop™ Arc Flash 100% Tie-Off Stretch Web Shock-Absorbing Lanyard 1246527, Kevlar® Fiber, 6 ft

3M Product Number 1246527 3M ID 7012817319

Details

- Stretches in reaction to users movements
- Energy absorbing design limits fall arrest forces
- Abrasion-resistant webbing
- Available in a wide range of web styles and designs
- Built-in impact indicator
- Protected labels equipped with 3M™ Connected Safety ID (CSID)
- Ideal for the following applications: Construction, General Industrial, Mining, Oil & Gas, Transportation, Utilities, and Wind Energy

Typical properties

- Anchor Connection Type
 - Rebar Hook
- Anchor Hook Material
 - Zinc Plated Steel
- Brands
 - DBI-SALA®
- Case Quantity
 - 1
- Connected Safety ID Equipped
 - Yes
- Energy Absorber Class
 - 6 ft (1.8 m) Free Fall/MAAF 900 lbs. (4 kN)
- Harness Connection Hook Material
 - Alum

Dimensions and Classifications

- Overall Length (Imperial)
 - 6 ft
- Overall Length (Metric)
 - 1.83 m

3M™ DBI-SALA® EZ-Stop™ Arc Flash Stretch Web Shock-Absorbing Lanyard 1246518, Kevlar® Fiber, 6 ft

3M Product Number 1246518 3M ID 7012817310

Details

- Stretches in reaction to users movements
- Energy absorbing design limits fall arrest forces
- Abrasion-resistant webbing
- Available in a wide range of web styles and designs
- Built-in impact indicator
- Protected labels equipped with 3M™ Connected Safety ID (CSID)
- Ideal for the following applications: Construction, General Industrial, Mining, Oil & Gas, Transportation, Utilities, and Wind Energy

Typical properties

- Anchor Connection Type
 - Snap Hook
- Anchor Hook Material
 - Zinc Plated Steel
- Brands
 - DBI-SALA®
- Case Quantity
 - 1
- Connected Safety ID Equipped
 - Yes
- Energy Absorber Class
 - 6 ft (1.8 m) Free Fall/MAAF 900 lbs. (4 kN)
- Harness Connection Hook Material
 - Zinc

Dimensions and Classifications

- Overall Length (Imperial)
 - 6 ft
- Overall Length (Metric)
 - 1.83 m

3M™ DBI-SALA® EZ-Stop™ Arc Flash 100% Tie-Off Stretch Web Shock-Absorbing Lanyard 1246526, Kevlar® Fiber, 6 ft

3M Product Number 1246526 3M ID 7012817317

Details

Stretches in reaction to users movements
Energy absorbing design limits fall arrest forces
Abrasion-resistant webbing
Available in a wide range of web styles and designs
Built-in impact indicator
Protected labels equipped with 3M™ Connected Safety ID (CSID)
Ideal for the following applications: Construction, General Industrial, Mining, Oil & Gas, Transportation, Utilities, and Wind Energy

Typical properties

Anchor Connection Type
Rebar Hook
Anchor Hook Material
Zinc Plated Steel
Brands
DBI-SALA®
Case Quantity
1
Connected Safety ID Equipped
Yes
Energy Absorber Class
6 ft (1.8 m) Free Fall/MAAF 900 lbs. (4 kN)
Harness Connection Hook Material
Alum

Dimensions and Classifications

Overall Length (Imperial)
6 ft
Overall Length (Metric)
1.83 m

3M™ DBI-SALA® ShockWave™ Arc Flash 100% Tie-Off Stretch Web Shock-Absorbing Lanyard 1246525, 6 ft

3M Product Number 1246525 3M ID 7100302294 UPC 00648250241127

Details

- Stretches in reaction to users movements
- Energy absorbing design limits fall arrest forces
- Abrasion-resistant webbing
- Available in a wide range of web styles and designs
- Built-in impact indicator
- Protected labels equipped with 3M™ Connected Safety ID (CSID)
- Ideal for the following applications: Construction, General Industrial, Mining, Oil & Gas, Transportation, Utilities, and Wind Energy

Typical properties

- Anchor Connection Type
 - Rebar Hook
- Anchor Hook Material
 - Aluminum
- Brands
 - DBI-SALA®
- Case Quantity
 - 1
- Connected Safety ID Equipped
 - Yes
- Energy Absorber Class
 - 6 ft (1.8 m) Free Fall/MAAF 900 lbs. (4 kN)
- Harness Connection Hook Material
 - Aluminum
- Har

Dimensions and Classifications

- Overall Length (Imperial)
 - 6 ft
- Overall Length (Metric)
 - 1.83 m

3M™ DBI-SALA® Reusable Freestanding Counterweight Roof Top Anchor Lifting Sling Kit 2104190

Part Number 2104190 3M Product Number 2104190 3M ID 7100314286

Details

Lightweight and durable polyester web construction
Meets the requirements for 29 CFR OSHA 1910.140, and OSHA 1926.502
Recommended for use in multiple industries including construction, mining, oil and gas, transportation, utilities, and wind energy
Adjustable designs available to accommodate a variety of different sized structures
Compatible with various fall arrest systems
This safety equipment is designed for use with additional personal fall arrest systems
Features high-strength steel hardware
Portable and reusable
Ideal anchorage device for scaffolding or piping
Web sling lifting kit for 3M™ DBI-SALA® Rooftop Freestanding Counterweight Anchor 2100180
Lifting kit brackets attach web sling to counterweights. Hardware kit included

Typical properties

Brands
DBI-SALA®
Case Quantity
1
Connected Safety ID Equipped
No
For Use With
Roof Top Counterweight Anchor
Install Type
Reusable
Material
Polyester
Net Weight (Imperial)
15 lb
Net Weight (Metric)
6.8 kg
Product Color
Silver
Product Type

3M™ DBI-SALA® Web D-ring Extension Anchor 1231305, Polyester, 1.58 ft

Part Number 1231305 3M Product Number 1231305 3M ID 7100260184

Details

Lightweight and durable polyester web construction
Meets the requirements for 29 CFR OSHA 1910.140, and OSHA 1926.506
Recommended for use in multiple industries including construction, mining, oil and gas, transportation, utilities, and wind energy
Adjustable designs available to accommodate a variety of different sized structures
Compatible with various fall arrest systems
This safety equipment is designed for use with additional personal fall arrest systems
Features high-strength steel hardware
Portable and reusable
Ideal anchorage device for scaffolding or piping
1.5 ft. (45 cm) web anchor strap
Unique hook with 3" (76.2mm) self closing and locking gate for added safety

Typical properties

Anchor Install Type
Reusable
Attachment Type
Hook
Brands
DBI-SALA®
Carabiner/Hook Material
Zinc Plated Steel
Case Quantity
1
Connected Safety ID Equipped
Yes
Install Type
Reusable
Material
Zinc Plated Steel
Product Color
Yellow
Product S

Dimensions and Classifications

Overall Length (Imperial)
1.5 ft

3M™ DBI-SALA® Temporary Rebar/Shear Stud Horizontal Lifeline End-Anchor Retro-Fit Kit 7400053

Part Number 7400053 3M Product Number 7400053 3M ID 7012820227

Details

Includes a rebar/shear stud base, tie-back assembly, end anchor, and intermediate bracket; stanchions and lifelines are sold separately
Compatible with single-span and multi-span lifeline configurations
Single-span systems hold up to 2 workers; multi-span systems hold up to 6 workers

Horizontal lifelines offer workers exceptional mobility on the job

Portable design is durable, yet lightweight, for easy transport

This safety equipment is intended for use with additional personal protective equipment (PPE)

Recommended for use in multiple industries including construction, facilities, general manufacturing, heavy infrastructure, and more

Zinc-plated steel materials are corrosion-resistant and stand up to harsh environments

Typical properties

Brands

DBI-SALA®

Case Quantity

1

Connected Safety ID Equipped

No

Install Type

Temporary/Portable

Lifeline Material

Order separately

Maximum Number of Workers

2 Per Span, 6 Total

Product Series

SecuraSpan™

Product Type

Concrete

Recommended

3M™ Adapter V-199/37069(AAD) 4 EA/Case

3M Product Number V-199 3M ID 7000002156 UPC 00051131370692

Details

Designed to adapt the V-100, V-200, V-300 and V-400 Air Regulating Valves

Typical properties

Brands

3M™

CFM Capacity per Minute

100 CFM, 53 CFM

Case Quantity

4/bag

Compatible With

3M™ Versaflo™ TR-800 Series Battery

Product Color

Black

Product Series

Fresh-Air III, Supplied Air, V-Series

Product Type

Adapter

Supplied Air Respirator

3M™ Inhalation Valve 7582, Replacement Part 10 EA/Bag

Part Number 52754 3M Product Number 7582 3M ID 7000002158

Details

Approved 3M™ replacement part
Designed for use with 3M™ Half Facepiece 7500 Series (sold separately)
Easy installation allows for quick replacement
Valve can extend service life of facepiece
Replaceable part can potentially result in respiratory equipment cost savings

Typical properties

Accessories
No
Brands
3M™
Case Quantity
10/tray
Clip-on Welding Shield
No
Compatible Respirator
7500 Series
Compatible with 3M™ PAPR Systems
No
Compatible with 3M™ Supplied Air System
No
Compatible with Welding Shield
No
Cool Flow™ Exhalat

3M™ Secure Click™ Inhalation Valve Assembly FF-800-03, 10 ea/Case

3M Product Number FF-800-03 3M ID 7100265540

Details

The Inhalation Valve Assembly consists of the cartridge/filter adapter, retainer ring, and inhalation valve
Using this replacement part can extend the service life of respiratory protection equipment
Maintains the right level of protection and comfort
Quick and easy to fit

Typical properties

Accessories

Yes

Brands

Secure Click™

Case Quantity

10

Compatible Respirator

FF-800 Series, Secure Click™ HF-800 Series Full Facepiece Reusable Respirators

Compatible with 3M™ PAPR Systems

No

Compatible with 3M™ Supplied Air System

No

Enhanced

Dimensions and Classifications

Overall Height (Imperial)

2.269 in

Overall Height (Metric)

57.623 mm

Overall Length (Imperial)

2.637 in

Overall Length (Metric)

66.983 mm

Overall Width (Imperial)

2.115 in

Overall Width (Metric)

53.733 mm

3M™ Inhalation Valve 6893/07144(AAD), System Component 200 EA/Case

3M Product Number 6893 3M ID 7000002049 UPC 50051131071440

Details

Approved 3M replacement part

Using this replacement part can extend the service life of respiratory protection equipment

Replacement part can extend service life of facepiece

Replaceable inhalation valve can potentially result in respiratory equipment cost savings

Valve maintains original service performance of facepiece

Typical properties

Accessories

No

Brands

3M™

Case Quantity

40/pack

Clip-on Welding Shield

No

Compatible Respirator

6000 Series

Compatible with 3M™ PAPR Systems

No

Compatible with 3M™ Supplied Air System

No

Compatible with Welding Shield

No

Cool Flow™ Exhalat

3M™ Center Adapter Assembly 6864/37000(AAD), 5 EA/Case

3M Product Number 6864 3M ID 7000002178 UPC 50051131370000

Details

This product features a proprietary design exhalation valve that increases user comfort by making breathing exhalation easier

The unique valve cover design also enhances the protection of the exhalation valve from debris

Unique cover design protects the exhalation valve from debris

Assembly includes one 3M Center Adapter Gasket 6896 and one 3M Exhalation Valve 7583

Designed to be used with the 3M Full Facepiece Respirator models 6700, 6800, and 6900 (sold separately)

Typical properties

Accessories

No

Boxes per Case

1

Brands

3M™

Case Quantity

1/case

Clip-on Welding Shield

No

Compatible Respirator

6000 Series

Eye Protection

No

Facepiece Type

Full Facepiece Reusable

Number per Box

5

Product Code

6864

Product Series

600

3M™ Speedglas™ G5-01 Pivot and Sliding Mechanism 46-0400-52, Including Pivot Knobs, 1 ea/Case

3M Product Number 46-0400-52 3M ID 7100289276 UPC 00638060434802

Details

Replacement spare part for the 3M™ Speedglas™ G5-01 Heavy-Duty Welding Helmet

Can be used to replace an existing 3M™ Speedglas™ G5-01 Pivot and Sliding Mechanism with Pivot Knobs

To be ordered if the pivot and sliding mechanism has become damaged and needs replacement

Package contains one 3M™ Speedglas™ G5-01 Pivot and Sliding Mechanism with Pivot Knobs

For maximum safety and comfort, regularly check your equipment for damaged or worn-out components

Gain access to refurbishment, repairs, replacement parts, and advice on how to take care of your safety equipment through a 3M™ Speedglas™ Warranty and Service Plan; visit 3m.com/SGwarranty to register your product

Typical properties

Brands

Speedglas™

Case Quantity

1

Compatible Welding Helmet

G5-01 Welding Helmets

Product Color

Black

Product Series

G5

Product Type

Pivot & Sliding Mechanism

Recommended Application

Grinding, Metal Processing, Metal Repair, Welding

eClass 1

3M™ Speedglas™ G5-01 Pivot Knob, 46-0400-58, 1 EA/Case

3M Product Number 46-0400-58 3M ID 7100215096 UPC 00076308944957

Details

Spare part pivot knob

For maximum safety and comfort, make it a habit to check your equipment regularly

Replace worn out or damaged parts

Typical properties

Brands

Speedglas™

Case Quantity

1 EA/Case

Compatible Welding Helmet

G5-01 Welding Helmets

Product Color

Black

Product Series

G5

Product Type

Pivot Knob

Recommended Application

Grinding, Metal Processing, Metal Repair, Welding

Recommended Ind

3M™ DBI-SALA® Fixed Beam Anchor 2108406, 1 EA

Part Number 2108406 3M Product Number 2108406 3M ID 7100188829

Details

Compatible with various fall protection systems

Compact, lightweight design

Ideal for use with personal fall arrest systems with self-retracting lifelines

Recommended for use in the construction, general industrial, mining, oil and gas, transportation, utilities, and wind energy industries

Portable and reusable

Corrosion-resistant construction for durability

This safety equipment is designed for use with additional personal protective equipment (PPE)

Fixed beam anchor fits variable width I-beams

Attach in any orientation or direction with detent style attachment with built-in tightening handle

High strength steel and aluminum construction with Swiveling D-ring tie-off point
ANSI / ASSP Z359.18 and meets the requirements of 29 CFR OSHA 1910.140, OSHA 1926

Typical properties

Anchor Install Type

Reusable

Attachment Type

Clamp

Brands

DBI-SALA®

Case Quantity

1

Connected Safety ID Equipped

Yes

Fits Ibeam Flange Width

2-1/2 to 12 in. (6.3-30.5cm)

Install Type

Reusable

Material

Zinc Plated Steel

Product Color

Silve

3M™ PELTOR™ Hygiene Kit for Optime™ I Ear Muffs, HY51

3M ID 7000039638 UPC 07318640033788

Details

Kit contains replacement sealing rings and muffler pads which can be replaced in a few easy steps
Extends the life of earmuffs
Ensures good function and hygiene
Avoid wearing uncomfortable earmuffs

Typical properties

Brands
PELTOR™
Compatible Earmuff
Optime I
Hearing Protection Style
Hygiene Kit
Metal Detectable
No
Product Color
Black
Product Series
HY51
Product Type
Hygiene Kit
Recommended Industry
Agriculture
eClass 14 Classification Group
40270191

3M™ PELTOR™ Optime™ 101 Earmuff Hygiene Kit HY7, 20 KT/Case

3M Product Number HY7 3M ID 7000009662 UPC 04046719416615

Details

Extend the life of earmuffs with 1 pair of replacement cushions and 1 pair of foam inserts

Hygiene Kit for H7 Series

20 Kits EA/Case

*The NRR may overestimate the hearing protection provided during typical use

Typical properties

Brands

PELTOR™

CSA Class

CSA Class AL

Case Quantity

20

Compatible Earmuff

Optime 101

Dielectric

No

Electrically Insulated

No

Hearing Protection Style

Hygiene Kit

Hygiene Kit

Yes

Material

Polyurethane

Product Color

Black

Product Series

3M™ PELTOR™ Hygiene Kit for Optime™ III Earmuffs, HY54

3M ID 7000108016 UPC 07318640033801

Typical properties

Brands
PELTOR™
Compatible Earmuff
Optime III
Hearing Protection Style
Hygiene Kit
Metal Detectable
No
Product Color
Black
Product Series
HY3, Optime
Product Type
Hygiene Kit
Recommended Industry
Agriculture
eClass 14 Classification Group

3M™ Safety and Inspection Manager Software, Basic Unlimited Fall Protection

3M Product Number SIM-BASIC 3M ID 6100003184

Details

Enhance Compliance Processes - gain easier access to audit information, which means greater assurance of worker and workplace compliance

Save Time - digital inspection management reduces paperwork and time spent on documentation and compliance tasks

Be Proactive - on-demand reporting provides a direct line of sight on selected compliance metrics in real-time, helping users gain potentially valuable safety insights

Cloud-based for simple deployment and easier maintenance

Typical properties

Brands

3M™

Product Type

Software

Recommended Application

Connected Safety

Recommended Industry

Construction, Food & Beverage

Supported Mobile Devices

Refer to Technical Specification Sheet

eClass 14 Classification Group

13030200

3M™ DBI-SALA® Rope Adjustable Positioning Lanyard, Trigger, 1234085

Part Number 1234085 3M Product Number 1234085 3M ID 7100157040

Details

Available in 6 ft., 8ft., and 10 ft. models with adjustable single-leg lanyard or twin leg lanyard models
Ideal for work positioning or restraint
Abrasion resistant polyester webbing
User friendly self locking snap hooks at each end
Equipped with i-Safe™

Typical properties

Anchor Connection Type
Rebar Hook
Anchor Hook Material
Aluminum
Brands
DBI-SALA®
Carabiner/Hook Material
Aluminum
Case Quantity
1
Connected Safety ID Equipped
Yes
Dimensions
8 ft. (2.4m)
Harness Connection Type
Carabiner
Install Type
Remo

3M™ DBI-SALA® Rope Adjustable Positioning Lanyard, Trigger, 1234084

Part Number 1234084 3M Product Number 1234084 3M ID 7100157049

Details

Available in 6 ft., 8ft., and 10 ft. models with adjustable single-leg lanyard or twin leg lanyard models
Ideal for work positioning or restraint
Abrasion resistant polyester webbing
User friendly self locking snap hooks at each end
Equipped with i-Safe™

Typical properties

Anchor Connection Type
Rebar Hook
Anchor Hook Material
Alloy Steel
Brands
DBI-SALA®
Carabiner/Hook Material
Alloy Steel
Case Quantity
1
Connected Safety ID Equipped
Yes
Dimensions
8 ft. (2.4m)
Harness Connection Type
Carabiner
Install Type

3M™ DBI-SALA® Rope Adjustable Positioning Lanyard, Trigger, 1234087

Part Number 1234087 3M Product Number 1234087 3M ID 7100157043

Details

Available in 6 ft., 8ft., and 10 ft. models with adjustable single-leg lanyard or twin leg lanyard models
Ideal for work positioning or restraint
Abrasion resistant polyester webbing
User friendly self locking snap hooks at each end
Equipped with i-Safe™

Typical properties

Anchor Connection Type
Rebar Hook
Anchor Hook Material
Aluminum
Brands
DBI-SALA®
Carabiner/Hook Material
Aluminum
Case Quantity
1
Connected Safety ID Equipped
Yes
Dimensions
10 ft. (3m)
Harness Connection Type
Carabiner
Install Type
Remov

3M™ DBI-SALA® Rope Adjustable Positioning Lanyard, Trigger, 1234086

Part Number 1234086 3M Product Number 1234086 3M ID 7100157034

Details

Available in 6 ft., 8ft., and 10 ft. models with adjustable single-leg lanyard or twin leg lanyard models
Ideal for work positioning or restraint
Abrasion resistant polyester webbing
User friendly self locking snap hooks at each end
Equipped with i-Safe™

Typical properties

Anchor Connection Type
Snap Hook
Anchor Hook Material
Aluminum
Brands
DBI-SALA®
Carabiner/Hook Material
Aluminum
Case Quantity
1
Connected Safety ID Equipped
Yes
Dimensions
8 ft. (2.4m)
Harness Connection Type
Carabiner
Install Type
Remov

3M™ DBI-SALA® Rope Adjustable Positioning Lanyard, Trigger, 1234088

Part Number 1234088 3M Product Number 1234088 3M ID 7100157053

Details

Available in 6 ft., 8ft., and 10 ft. models with adjustable single-leg lanyard or twin leg lanyard models
Ideal for work positioning or restraint
Abrasion resistant polyester webbing
User friendly self locking snap hooks at each end
Equipped with i-Safe™

Typical properties

Anchor Connection Type
Rebar Hook
Anchor Hook Material
Alloy Steel
Brands
DBI-SALA®
Carabiner/Hook Material
Alloy Steel
Case Quantity
1
Connected Safety ID Equipped
Yes
Dimensions
10 ft. (3m)
Harness Connection Type
Carabiner
Install Type

3M™ DBI-SALA® Wedge Grip Horizontal Lifeline Termination Device 7608008

Part Number 7608008 3M Product Number 7608008 3M ID 7012820345

Details

Stanchions, lifelines, bases, and Metal Energy Energy Absorbers all sold separately

Constructed of durable materials

Recommended for use in multiple industries including construction, facilities, power plants, general manufacturing, heavy infrastructure, and more

Single-span systems hold up to 2 workers; multi-span systems hold up to 6 workers

Compatible with galvanized and stainless steel lifeline cables

This safety equipment is designed to work with additional personal protective equipment (PPE)

Portable design is durable, yet lightweight, for easy transport

Intended for use in a temporary horizontal lifeline system

Metal Energy Absorbers help protect the structure, and minimize needed fall clearance

Typical properties

Brands

Rollgliss™ Technical Rescue

Case Quantity

1

Connected Safety ID Equipped

No

For Use With

Sayflite & SecuraSpan Replacement Lifelines

Install Type

Temporary/Portable

Lifeline Material

Order separately

Maximum Number of Workers

None

Net

3M™ Clear Polycarbonate Faceshield V2C-10P 10 ea/Case

3M Product Number V2C-10P 3M ID 7000103812 UPC 10093045936202

Details

High impact face protection
Lightweight
Polycarbonate faceshield is 8.25" x 12.125"
Must be attached to hard hat

Typical properties

Brands
PELTOR™
Case Quantity
10
For Use With
3M™ Peltor™ Cap-mounted Earmuffs, 3M™ Peltor™ Hard Hat Adapter P3EV/2
Product Type
Faceshield
Recommended Application
Assembly, Cleaning, Demolition, Electrical, Facility Maintenance, Grinding,
Machine

Dimensions and Classifications

Overall Height (Imperial)
8.25 in
Overall Height (Metric)
21 cm
Overall Length (Imperial)
12.125 in
Overall Length (Metric)
30.8 cm
Overall Width (Imperial)
8.25 in
Overall Width (Metric)
20.96 cm

3M™ Elevated Temperature Aluminum Front Helmet Cover, FC1-AL, Silver, 60 EA/Case

3M Product Number FC1-AL 3M ID 7100082486 UPC 04054596088276

Details

Designed for 3M™ hard hats with face shield holder
Designed to provide additional protection to the wearer and the safety helmet
Reduces the possibility of particulate dropping into the users face when the faceshield is lifted

Typical properties

Brands
3M™
Compatible Hard Hat
H-700T, H24T
For Use With
Hard Hats
High Heat
Yes
Material
Aluminized Fabric
Product Color
Silver
Product Type
Front Helmet Cover
eClass 14 Classification Group
46080105

3M™ Versaflo™ High Durability Hood with Integrated Head Suspension S-533L, Medium/Large, 1 EA/Case

3M Product Number S-533L 3M ID 7000052767 UPC 00051131170872

Details

Size: Medium/Large

Typical properties

Assigned Protection Factor

1000

Brands

Versaflo™

CFM Capacity per Minute

100 CFM, 50 CFM

Compatible With

3M™ Powered Air Purifying and Supplied Air Respirator Systems

Headgear Type

Hood with Suspension

High Heat

No

Material

Polyurethane Coate

3M™ PELTOR™ X3 Earmuffs X3P3E/37277(AAD), Hard Hat Attached, 10 EA/Case

3M Product Number X3P3E 3M ID 7000104077 UPC 10093045937308

Details

Hard hat attached hearing protection with Noise Reduction Rating (NRR) of 25 dB for moderate to high noise exposure
Fits a wide range of industrial safety hard hats, including 3M™ H-700 Series Hard Hats (sold separately)
Attaches directly to many hard hats without an adapter
Earcups tilt to ensure a customized fit and comfort for individual users
Adjustable earcups may be placed in three positions: 1) Usage position 2) Stand-by position, or 3) Storage position

Typical properties

Attenuation Rating
25.0 Decibel
Brands
PELTOR™
Case Quantity
10
Corded
No
Dielectric
No
Earmuff Style
Hard Hat Attached
Electrically Insulated
No
Hearing Protection Style
Hard Hat Attached
Metal Detectable
No
Moisture Resistant
No
Prod

3M™ PELTOR™ X3 Earmuffs X3P5E, Electrically Insulated, Hard Hat Attached, 10 ea/Case

3M Product Number X3P5E 3M ID 7100097405 UPC 10078371671027

Details

Electrically insulated: Appropriate for a wide range of applications*
High-performance arms: Balance durability and flexibility
Easy click in/ click out: Move cups on and off ears easily
Convenient storage: Store with cups clicked in or out
Compatibility with hard hats: Designed for use with a standard hard hat slot**
Fit can be confirmed: Verify with 3M™ E-A-Rfit™ Dual-Ear Validation System***
Series has a wide range of attenuation: Choose from 21 dB NRR to 31 dB NRR
*These earmuff cups are made of non-conductive (sometimes referred to as “dielectric”) material while the metal components of the headbands and the helmet attachment mechanisms are covered in non-conductive material. This product was found to be electrically insulated, withstanding a voltage up to 1.2 kV, at an external laboratory against a modified test method based on EN 397:2012 under dry conditions. The user must determine the overall suitability of this product for the intended application taking into account any hazards other than noise for which this product is tested and approved. **This product was designed and tested with a 3M Hard Hat H700. For information on other hard hat models contact 3M. ***3M strongly recommends fit testing of hearing protectors. Research suggests that many users will receive less noise reduction than indicated by the NRR due to variation in earmuff fit, earmuff fitting skill and motivation of the user. If NRR is used, 3M recommends that it be reduced by 50% or in accordance with applicable regulations

Typical properties

Attenuation Rating
25.0 Decibel
Bluetooth
No
Brands
PELTOR™
Case Quantity
10
Corded
No
Dielectric
Yes
Earmuff Style
Hard Hat Attached
Electrically Insulated
Yes
Hearing Protection Style
Hard Hat Attached
Hearing Protection Type
Hard Hat

3M™ PELTOR™ X3 Earmuffs X3A/37272(AAD), Over-the-Head, 10 EA/Case

Part Number 37272 3M Product Number X3A 3M ID 7000104072

Details

Over-the-head hearing protection with Noise Reduction Rating (NRR) of 28 dB for moderate to high noise exposure

Twin headband design helps reduce heat buildup with good fit and balance

Wire headband offers comfortable pressure during prolonged usage

Earcups tilt to ensure a customized fit and comfort for individual users

Electrically insulated (dielectric) wire headband helps reduce exposure to electrical hazards

Typical properties

Attenuation Rating

28.0 Decibel

Bluetooth

No

Brands

PELTOR™

Case Quantity

10

Corded

No

Dielectric

Yes

Earmuff Style

Over the Head

Electrically Insulated

Yes

Hearing Protection Style

Over-the-Head

Hygiene Kit

HYX3

Metal Detectable

No

3M™ PELTOR™ Earmuff Assembly M-985/37333(AAD), for Versaflo™ M-100 and M-300 Products, Pair, 1 EA/Case

3M Product Number 37333 3M ID 7100004873

Details

M-985 earmuff assembly for Versaflo™ M-100 and M-300 products

NRR 24

3M PSD products are for occupational use only

*The NRR may overestimate the hearing protection provided during typical use

Typical properties

Attenuation Rating

24.0 Decibel

Bluetooth

No

Brands

PELTOR™

Case Quantity

1

Cord Type

None

Dielectric

No

Earmuff Style

Hard Hat Attached

Electrically Insulated

No

Hearing Protection Style

Hard Hat Attached

Hearing Protection Type

Headba

3M™ DBI-SALA® Nano-Lok™ Self-Retracting Lifeline with Quick Connect 3100618, Web, Wrap Back, 8 ft.

3M Product Number 3100618 3M ID 7012818585 UPC 00648250243190

Details

- Quick activating speed sensing brake systems
- Built-in pin-style connector for direct attachment to harness
- Wrap back design with specialized Dyneema® web lifeline
- Durable thermoplastic housing

Typical properties

- ANSI Class Level
- Class 1
- Average Arrest Force (Imperial)
- 1125 lbf (ANSI), 1125 lbf (OSHA 130 lb - 310 lb), 1125 lbf (OSHA up to 420 lb)
- Average Arrest Force (Metric)
- 5 kN (ANSI)
- Brands
- DBI-SALA®
- Connected Safety ID Equipped
- Yes
- Harness Connectio

Dimensions and Classifications

- Overall Length (Imperial)
- 8 ft
- Overall Length (Metric)
- 2.4 m

3M™ DBI-SALA® Nano-Lok™ Twin-Leg Self-Retracting Lifeline with Quick Connect 3100617, Web, Wrap Back, 8 ft.

3M Product Number 3100617 3M ID 7012818584 UPC 00648250243183

Details

- Quick activating speed sensing brake systems
- Built-in pin-style connector for direct attachment to harness
- Wrap back design with specialized Dyneema® web lifeline
- Durable thermoplastic housing

Typical properties

- ANSI Class Level
- Class 1
- Average Arrest Force (Imperial)
- 1125 lbf (ANSI), 1125 lbf (OSHA 130 lb - 310 lb), 1125 lbf (OSHA up to 420 lb)
- Average Arrest Force (Metric)
- 5 kN (ANSI)
- Brands
- DBI-SALA®
- Connected Safety ID Equipped
- Yes
- Harness Connectio

Dimensions and Classifications

- Overall Length (Imperial)
- 8 ft
- Overall Length (Metric)
- 2.4 m

3M™ DBI-SALA® EZ-Line™ Retractable Horizontal Lifeline System 7605060, 1 EA

Part Number 7605060 3M Product Number 7605060 3M ID 7100188820

Details

Robust galvanized temporary horizontal cable lifeline
Retractable horizontal cable system can be set at any length up to 60 ft. (18.3 m)
User-friendly design makes it easy to transport to and from job sites using the carrying handle
Built-in winch, pre-tension, and impact indicator
Durable construction designed to help stand up to harsh conditions
Single and multi-span compatible
Internal energy absorber helps limit fall arrest forces
Equipped with RFID
Achieves proper tension with an audible click
Tethered crank handle to help prevent loss

Typical properties

Brands
DBI-SALA®
Case Quantity
1
Connected Safety ID Equipped
Yes
Install Type
Temporary/Portable
Lifeline Length (Imperial)
60 ft
Lifeline Length (Metric)
18.28 m
Lifeline Material
Galvanized Cable
Maximum Number of Workers
2 Per Span, 6 T

Dimensions and Classifications

Overall Length (Imperial)
60 ft

3M™ DBI-SALA® SecuraSpan™ Perpendicular I-Beam HLL Stanchion Intermediate Bracket 7400089, Order Separately, 1 ea

Part Number 7400089 3M Product Number 7400089 3M ID 7100220292

Details

Hardware kit included to bolt to existing horizontal I-beam stanchion
Various lengths and individual components are available
Pass-thru 100% tie-off protection
Lightweight and portable design
Extremely durable construction
Various lengths and individual components are available

Typical properties

Brands
DBI-SALA®
Case Quantity
1
Connected Safety ID Equipped
No
For Use With
3M™ DBI-SALA® SecuraSpan™ I-Beam System
Install Type
Temporary/Portable
Lifeline Material
Order separately
Maximum Number of Workers
2 Per Span, 6 Total
Net Weight

3M™ DBI-SALA® Temporary I-Beam Horizontal Lifeline Stanchion Intermediate Bracket 7400008

Part Number 7400008 3M Product Number 7400008 3M ID 7100314307

Details

Hardware kit included to bolt to existing horizontal I-beam stanchion
Various lengths and individual components are available
Pass-thru 100% tie-off protection
Lightweight and portable design
Extremely durable construction
Various lengths and individual components are available

Typical properties

Brands
DBI-SALA®
Case Quantity
1
Connected Safety ID Equipped
No
For Use With
3M™ DBI-SALA® SecuraSpan™ I-Beam System
Install Type
Temporary/Portable
Lifeline Material
Order separately
Material
Zinc Plated Steel
Maximum Number of Workers
2

3M™ Frame Kit 6899/37007(AAD), 5 EA/Case

3M Product Number 6899 3M ID 7100001832 UPC 50051131370079

Details

Approved 3M replacement part
Designed for 3M Full Facepiece 6000 Series (sold separately)
Use to secure 3M Lens assembly 6898 (sold separately) to facepiece
Replacement part can extend service life of facepiece
Replaceable part can potentially result in respiratory equipment cost savings

Typical properties

Accessories
No
Boxes per Case
5
Brands
3M™
Cartridge or Filter Included
No
Case Quantity
5/case
Clip-on Welding Shield
No
Compatible Respirator
6000 Series
Compatible with 3M™ PAPR Systems
No
Compatible with 3M™ Supplied Air System
No
Co

3M™ Respirator Replacement Strap 7580 40 EA/Bag

3M Product Number 7580 3M ID 7000127455 UPC 50051131172239

Details

Approved 3M replacement part
Designed for use with 3M Respirators 7501, 7502, and 7503 (sold separately)
Maintains original performance standards of respirator
Easy to attach to respirator
Replaceable part can potentially result in respiratory equipment cost savings

Typical properties

Accessories
No
Brands
3M™
Case Quantity
40
Clip-on Welding Shield
No
Compatible with 3M™ PAPR Systems
No
Compatible with 3M™ Supplied Air System
No
Compatible with Welding Shield
No
Cool Flow™ Exhalation Valve
No
Drop-down Feature
No
Enh

3M™ Reusable Nylon Respirator Storage Bag FF-400-25 10 EA/Case

3M Product Number FF-400-25 3M ID 7000052878 UPC 50051131173380

Details

Nylon respirator storage bag with drawstring
Can be used to store any of the 3M™ 6000, 7000 and FF-400 Series half and full facepiece respirators
10 per case
Color: black

Typical properties

Accessories
Yes
Boxes per Case
10
Brands
3M™
Case Quantity
10/case
Clip-on Welding Shield
No
Compatible Respirator
FF-400 Series
Compatible with 3M™ PAPR Systems
No
Compatible with 3M™ Supplied Air System
Yes
Compatible with Welding Shield

Dimensions and Classifications

Overall Height (Imperial)
15 in
Overall Height (Metric)
381 mm
Overall Width (Imperial)
13 in
Overall Width (Metric)
330.2 mm

3M™ Speedglas™ Welding Starter Kit 9100V 06-0201-10, 1 EA/Case

3M Product Number 06-0201-10 3M ID 7010341130 UPC 00051141561981

Details

Welding kit includes 5 outside protection plates, 2 inside protection plates, and 1 sweat pad

Integrates with 3M™ 9100 Series ADF

Applications include metal repair, assembly, and mechanical

For use in the construction, heavy infrastructure, and industrial maintenance industries

Full ADF assembly meets the requirements of ANSI Z87.1-2010

Typical properties

Brands

Speedglas™

Case Quantity

1

Compatible Welding Helmet

9100 Series

Features

9100 Series Accessory

Product Series

9100, 9100 FX, 9100 MP, 9100 QR, 9100-Air, L-Series

Recommended Application

Assembly & Mechanical, Metal Repair

Recommended I

3M™ E-A-R Caps™ Model 200 Hearing Protector 321-2101, 100 EA/Case

3M Product Number 321-2101 3M ID 7000052716 UPC 10080529210019

Details

Soft foam caps block the entrance to the ear canal. Band is worn under the chin
Ideal for intermittent protection needs

Noise Reduction Rating (NRR)* 17 dB. CSA Class BL

*The NRR may overestimate the hearing protection provided during typical use

Typical properties

Banded

Yes

Brands

E-A-R™

Case Quantity

100

Corded

Yes

Dielectric

No

Earplug Material

Foam/Thermoplastic

Earplug Shape

Round

Earplug Size

Regular

Electrically Insulated

Yes

Hearing Protection Style

Banded

Insertion Style

No Roll

Mater

3M™ PELTOR™ ProTac III MT13H221A, Headset, Black, Headband, 10 Each/Case

3M Product Number MT13H221A 3M ID 7100088424 UPC 04054596123229

Details

Professional-Quality Hearing Protection (26dB NRR)
Environmental microphones for level-dependent hearing protection and ambient listening
3.5 mm listen-only stereo input for connection to external devices (e.g. cell phone, two-way radio, Ipod)
Voice guided menu system for ease of use and adjusting settings
Auto power off, the headset will turn off after 4 hrs of non-use to save battery
Low-battery warning to inform you when to change batteries
To reduce corrosion caused by sweat and moisture, the electronics are located in a separate compartment of the cup
Available in both in headband and hard hat attached versions (black)
Occupational use only

Typical properties

Attenuation Rating
26 dB
Audio Type
Communication
Auxiliary Port
3.5mm
Battery Life
100 Hours
Bluetooth
No
Brands
PELTOR™
Built In FM and or AM Radio
No
Built in 2-Way Radio
No
Case Quantity
10
Communication Direction
Listen-only
Commu

3M™ Protecta® Equipment Carrying and Storage Bag AK066A, 9.5 in x 10 in x 15.5 in

Part Number AK066A 3M Product Number AK066A 3M ID 7012822285

Details

Equipment carrying and storage bag
Size 9.5 in. x 10 in. x 15.5 in. (24.1 x 25.4 x 39.4 cm)
Built-in web carrying handles
Heavy-duty zipper
Durable nylon construction with PVC lining
Removable shoulder strap
Compact and lightweight design

Typical properties

Brands
PROTECTA®
Case Quantity
1
Connected Safety ID Equipped
No
Product Color
Red
Product Series
PRO™
Product Type
Equipment Carrying & Storage Bag
Recommended Industry
Construction, General Industrial, Mining, Oil & Gas
Weight (Imperial)

3M™ Protecta® Equipment Carrying and Storage Bag for 8 ft Tripod AK067A

Part Number AK067A 3M Product Number AK067A 3M ID 7100252135

Details

Carrying/storage bag for PRO™ tripod
Lightweight and durable nylon construction
Built-in web carrying handles
Heavy-duty zipper closure

Typical properties

Brands
PROTECTA®
Case Quantity
1
Connected Safety ID Equipped
No
For Use With
Aluminum Tripods
Product Color
Black
Product Series
PRO™
Product Type
Carrying Bag
Recommended Industry
Construction, General Industrial, Oil & Gas, Transportatio

Dimensions and Classifications

Overall Length (Imperial)
65 in
Overall Length (Metric)
165.1 cm
Overall Width (Imperial)
12 in
Overall Width (Metric)
30.5 cm

3M™ DBI-SALA® Ultra-Lok™ Assisted Rescue Pole/Tool for RSQ Self-Retracting Lifeline 3500101, 6 - 12 ft

Part Number 3500101 3M Product Number 3500101 3M ID 7012819168

Details

Spare Parts
Disc Spring
Stainless Steel
Built-in handle and label access pockets
Designed to fit all DBI-SALA Sealed-Blok™ Retrieval SRL models
Locking pin and mounting bolts included

Typical properties

Brands
DBI-SALA®
Case Quantity
1
Connected Safety ID Equipped
No
For Use With
Ultra-Lok™ SRL
Net Weight (Metric)
2.1 kg
Product Color
Black, Yellow
Product Series
First-Man-Up™, Ultra-Lok™
Product Type
Pole with RSQ Assisted Rescue Tool (Fo

Dimensions and Classifications

Overall Length (Imperial)
6 ft

**3M™ DBI-SALA® Nano-Lok™ Cab Mount Bracket Hardware 3100271,
1 ea**

3M Product Number 3100271 3M ID 7100217571 UPC 00840779103393

Details

Spare Parts

Disc Spring

Stainless Steel

Built-in handle and label access pockets

Designed to fit all DBI-SALA Sealed-Blok™ Retrieval SRL models

Locking pin and mounting bolts included

3M™ Protecta® Self-Retracting Lifeline Cover 3590010, Fits 20 - 33 ft Standard Models

Part Number 3590010 3M Product Number 3590010 3M ID 7100257883

Details

Vinyl cover for Protecta-® self retracting lifelines; 6.1 m - 10 m standard cable and 6.1 m. leading edge models

Fast and easy to install

Lightweight and durable

Built-in handle and label access pockets

Designed to fit all DBI-SALA Sealed-Blok™ Retrieval SRL models

Locking pin and mounting bolts included

Typical properties

Brands

PROTECTA®

Case Quantity

1

Connected Safety ID Equipped

No

Material

Vinyl

Maximum Number of Workers

None

Product Type

Self Retracting Lifeline Cover

Recommended Industry

Construction, General Industrial, Mining, Oil & Gas, Transportatio

3M™ Protecta® Self-Retracting Lifeline Cover 3590011, Fits 50 ft Standard and 33 ft Leading Edge Models

Part Number 3590011 3M Product Number 3590011 3M ID 7100263465

Details

Vinyl cover for Protecta® self retracting lifelines; 15.2 m standard cable and 10 m leading edge models
Fast and easy to install
Lightweight and durable
Built-in handle and label access pockets
Designed to fit all DBI-SALA Sealed-Blok™ Retrieval SRL models
Locking pin and mounting bolts included

Typical properties

Brands
PROTECTA®
Case Quantity
1
Connected Safety ID Equipped
No
Product Type
Self Retracting Lifeline Cover
Recommended Industry
Construction, General Industrial, Mining, Oil & Gas, Transportation
Weight (Imperial)
0.34 lb.

3M™ Protecta® Mounting Bracket For 3-Way Retrieval Self-Retracting Lifeline 3590497, SRL Side Only

Part Number 3590497 3M Product Number 3590497 3M ID 7012819400

Details

Protecta® retrieval self retracting lifeline quick-connect bracket
Mates with support structure mounting base bracket (model 8008005)
Zinc plated steel construction
Simple bolt-on attachment to SRL
Compact design can be left in place indefinitely
Locking pin and mounting bolts included

Typical properties

Brands
PROTECTA®
Case Quantity
1
Connected Safety ID Equipped
No
Net Weight (Imperial)
1.7 lb
Net Weight (Metric)
0.8 kg
Product Color
Silver
Product Type
Retrieval Self Retracting Lifeline Mounting Bracket - SRL Side Only
Recommended Indust

3M™ Self-Retracting Lifeline Retrieval Mounting Bracket 3401065, Zinc Plated Steel, 50 ft

Part Number 3401065 3M Product Number 3401065 3M ID 7100311175

Details

Retrieval SRL Quick-mount bracket
Offers a quick mount system to tripod
Durable zinc plated steel construction
Compact and lightweight design
Designed to fit DBI-SALA 15m retrieval SRL models
Locking pin and mounting bolts included

Typical properties

Brands
DBI-SALA®
Case Quantity
1
Connected Safety ID Equipped
No
Product Color
Yellow Zinc
Product Type
Retrieval SRL Mounting Bracket
Recommended Industry
General Industrial, Mining, Oil & Gas, Utilities
Weight Capacity
None

3M™ Self-Retracting Lifeline Retrieval Mounting Bracket 3401123, Zinc Plated Steel, 85 ft

Part Number 3401123 3M Product Number 3401123 3M ID 7100311176

Details

Retrieval SRL Quick-mount bracket
Offers a quick mount system to tripod
Durable zinc plated steel construction
Compact and lightweight design
Designed to fit DBI-SALA 25m retrieval SRL models
Locking pin and mounting bolts included

Typical properties

Brands
Delta™
Case Quantity
1
Connected Safety ID Equipped
No
Product Color
Yellow Zinc
Product Type
Retrieval SRL Mounting Bracket
Recommended Industry
General Industrial, Mining, Oil & Gas, Utilities
Weight Capacity
None

**3M™ Self-Retracting Lifeline Retrieval Mounting Bracket 3401140,
Zinc
Plated Steel, 130 ft**

Part Number 3401140 3M Product Number 3401140 3M ID 7100311177

Details

Retrieval SRL Quick-mount bracket
Offers a quick mount system to tripod
Durable zinc plated steel construction
Compact and lightweight design
Designed to fit DBI-SALA 39m retrieval SRL models
Locking pin and mounting bolts included

Typical properties

Brands
DBI-SALA®
Case Quantity
1
Connected Safety ID Equipped
No
Product Color
Yellow Zinc
Product Type
Retrieval SRL Mounting Bracket
Recommended Industry
General Industrial, Mining, Oil & Gas, Utilities
Weight Capacity
None

3M™ DBI-SALA® Rollgliss™ Sealed Tension Limiter For Man-Riding Systems 3601490, Stainless Steel Cable, 23 ft

Part Number 3601490 3M Product Number 3601490 3M ID 7012693284

Details

Load limiting device connects worker and hoist line
For use if worker may be entangled or obstructed while on a hoist line
Visual warning system is brightly colored stainless steel wire rope lifeline
Corrosion-resistant, sealed construction protects against weather and debris
Built-in carrying handle for transport
Pivoting anchorage handle and carabiner included
23 ft. of lifeline
Recommended for oil and gas, and general industrial applications

Typical properties

Anchor Install Type
Reusable
Brands
DBI-SALA®
Case Quantity
1
Connected Safety ID Equipped
No
Descent Type
None
Dimensions
13.30x10.40x6.10in
Lifeline Material
Stainless Steel Wire Rope
Maximum Number of Users
One
Net Weight (Imperial)
26

Dimensions and Classifications

Overall Length (Imperial)
23 ft
Overall Length (Metric)
7 m

3M™ PROTECTA® Retrieval Self Retracting Lifeline Mounting Bracket, SRL Side and Tripod Base, 3590498

Part Number 3590498 3M Product Number 3590498 3M ID 7100230834

Details

Rebel™ retrieval self retracting lifeline quick-connect bracket (model 3590497)
Tripod mounting base bracket for mechanical device
Zinc plated steel construction
Simple bolt-on attachment to SRL
Fast and simple detent style mounting base attachment
Compact design can be left in place indefinitely

Typical properties

Brands
PROTECTA®
Manufacturing Origin
USA
Product Type
Retrieval Self Retracting Lifeline Mounting Bracket - SRL Side and Tripod Base
Weight (Metric)
2 kg

Dimensions and Classifications

Overall Height (Metric)
105.41 mm
Overall Length (Metric)
370.84 mm
Overall Width (Metric)
30.23 mm

3M™ DBI-SALA® SecuraSpan™ Fasten-in-Place HLL Clamp-on Vertical Base 7400211, 1 ea

Part Number 7400211 3M Product Number 7400211 3M ID 7100220278

Details

Bolt-on base for horizontal surfaces provides anchorage point for horizontal lifeline post
Ideal for fasten-in-place system on horizontal steel and concrete structures
Simple attachment with four fasteners (not included)
Heavy-duty portable design
Durable steel construction for strength and longevity
Various lengths and individual components are available

Typical properties

Brands

DBI-SALA®

Case Quantity

1

Connected Safety ID Equipped

No

Dimensions

6.72 in x 12.2 in x 6.5 in to 7.5 in (171 mm x 316 mm x 165 mm to 191 mm)

For Use With

3M™ DBI-SALA® SecuraSpan™ Pour-in-Place/Fasten-in-Place HLL system

Install Type

T

Dimensions and Classifications

Overall Height (Imperial)

12.2 in

Overall Height (Metric)

316 mm

Overall Width (Imperial)

6.7 in

Overall Width (Metric)

171 mm

3M™ DBI-SALA® SecuraSpan™ Fasten-in-Place HLL Bolt-on Floor Base 8530267, 1 ea

Part Number 8530267 3M Product Number 8530267 3M ID 7100220318

Details

Bolt-on base for horizontal surfaces provides anchorage point for horizontal lifeline post

Ideal for fasten-in-place system on horizontal steel and concrete structures

Simple attachment with four fasteners (not included)

Heavy-duty portable design

Durable steel construction for strength and longevity

Various lengths and individual components are available

Typical properties

Brands

DBI-SALA®

Case Quantity

1

Connected Safety ID Equipped

No

For Use With

3M™ DBI-SALA® SecuraSpan™ Pour-in-Place/Fasten-in-Place HLL system

Install Type

Temporary/Portable

Lifeline Material

Order separately

Maximum Number of Workers

2 Pe

3M™ DBI-SALA® SecuraSpan™ Fasten-in-Place HLL Bolt-on Vertical Base 7400218, 1 ea

Part Number 7400218 3M Product Number 7400218 3M ID 7100220280

Details

Bolt-on base for horizontal surfaces provides anchorage point for horizontal lifeline post
Ideal for fasten-in-place system on horizontal steel and concrete structures
Simple attachment with four fasteners (not included)
Heavy-duty portable design
Durable steel construction for strength and longevity
Various lengths and individual components are available

Typical properties

Brands
DBI-SALA®
Case Quantity
1,1 EA/Case
Connected Safety ID Equipped
No
For Use With
3M™ DBI-SALA® SecuraSpan™ Pour-in-Place/Fasten-in-Place HLL system
Install Type
Temporary/Portable
Lifeline Material
Order separately
Maximum Number of Wor

3M™ DBI-SALA® Temporary Fasten-In-Place Horizontal Lifeline Clamp-On Vertical Base For Concrete/Steel 8530373

Part Number 8530373 3M Product Number 8530373 3M ID 7100245937

Details

Bolt-on base for horizontal surfaces provides anchorage point for horizontal lifeline post
Ideal for fasten-in-place system on horizontal steel and concrete structures
Simple attachment with four fasteners (not included)
Heavy-duty portable design
Durable steel construction for strength and longevity
Various lengths and individual components are available

Typical properties

Brands
DBI-SALA®
Case Quantity
1
Connected Safety ID Equipped
No
Install Type
Temporary/Portable
Lifeline Material
Order separately
Maximum Number of Workers
2 Per Span, 6 Total
Product Series
SecuraSpan™ Pour/Fasten-in-Place
Product Type
F

3M™ DBI-SALA® Flexiguard™ Supported Ladder Rail Fixed Height Access Anchor System 8530397, 2 User, 9 ft High, 3 ft Wide

Part Number 8530397 3M Product Number 8530397 3M ID 7100325589

Details

9 ft. (2.7 m) platform height provides optimal access for transportation vehicle maintenance
9 ft. (2.7 m) platform length provides ample maneuvering space for 1-2 workers
12 ft. (3.7 m) fall arrest rail and trolley system for active fall protection
Non-slip working platform helps keep personnel on their feet
8 in. (20 cm) urethane wheels allow the system to be moved between jobs
Conforms to the requirements of OSHA 1926.502 and OSHA 1910.66
One part of your personal fall arrest system; intended for use with personal protective equipment (PPE) including (but not limited to) harnesses and self retracting lifelines
Suitable for numerous applications within the transportation industry

Typical properties

Brands
DBI-SALA®
Case Quantity
1
Connected Safety ID Equipped
Yes
Install Type
Temporary/Portable
Maximum Number of Users
Two
Product Color
Silver, Yellow
Product Series
FlexiGuard™
Product Type
Supported Ladder System
Recommended Industry

3M™ Protecta® Mounting Bracket For 3-Way Retrieval Self-Retracting Lifeline 3590499, SRL Side Only

Part Number 3590499 3M Product Number 3590499 3M ID 7100309559

Details

Rebel™ retrieval self retracting lifeline quick-connect bracket
Mates with DBI-SALA® support structure mounting base bracket
Fast and simple detent style mounting base attachment
Zinc plated steel construction
Simple bolt-on attachment to SRL
Compact design can be left in place indefinitely

Typical properties

Brands
PROTECTA®
Manufacturing Origin
USA
Product Type
Retrieval Self Retracting Lifeline Mounting Bracket - SRL Side Only
Weight (Metric)
0.93 kg

Dimensions and Classifications

Overall Height (Metric)
76.2 mm
Overall Length (Metric)
200.66 mm
Overall Width (Metric)
14.48 mm

3M™ DBI-SALA® Confined Space Winch/Self-Retracting Lifeline Mounting Bracket For Davit Mast 8549915

3M Product Number 8549915 3M ID 7100245940 UPC 00840779197408

Details

- Spare Parts
- Disc Spring
- Stainless Steel
- Built-in handle and label access pockets
- Designed to fit all DBI-SALA Sealed-Blok™ Retrieval SRL models
- Locking pin and mounting bolts included

Typical properties

- For Use With
- Digital Winch
- Product Type
- Mounting Bracket

3M™ PELTOR™ Welding Earmuff H505B, Behind-the-Head, 10 EA/Case

3M Product Number H505B 3M ID 7000103840 UPC 10093045936400

Details

Lightweight, low-profile design allows the earmuff to fit nicely under 3M™ Speedglas™ 9100 Series and other welding helmets

Soft ear cushions provide a comfortable seal and help reduce loud noise exposure

Semi-soft cup surface minimizes scratch sound transmission

Two-point suspension and wire headband with individual spring action help facilitate constant, even pressure distribution on the earmuff cushions for a secure, comfortable fit

Typical properties

Attenuation Rating

17.0 Decibel

Bluetooth

No

Brands

PELTOR™

Case Quantity

10

Cord Type

None

Corded

No

Dielectric

No

Earmuff Style

Behind the Head

Electrically Insulated

No

Hearing Protection Style

Behind-the-Head

Hearing Protection Typ

3M™ DBI-SALA® Flexiguard™ M100 Modular Jib Fork Pocket Kit 8530911

3M Product Number 8530911 3M ID 7100314339

Details

Enables mast to be separated from the base and transported vertically using a forklift

Designed to enable easy system transport

Helps maximize usage in various locations

Typical properties

Brands

DBI-SALA®

Connected Safety ID Equipped

No

Install Type

Temporary/Portable

Manufacturing Origin

USA

Net Weight (Imperial)

70 lb

Net Weight (Metric)

32 kg

Product Series

FlexiGuard™

Product Type

Modular Jib Accessory

Recommended Indus

Dimensions and Classifications

Overall Height (Metric)

220 mm

Overall Length (Metric)

650 mm

Overall Width (Metric)

34 mm

3M™ Versaflo™ High Temperature Breathing Tube Cover BT-926/L-199SG, 1 EA/Case

3M Product Number BT-926/L-199SG 3M ID 7000052729 UPC 00051135894514

Details

Breathing Tube Cover
High Temp Applications
Replacement Part

Typical properties

Brands
Versaflo™
Case Quantity
1
Compatible With
3M™ Versaflo™ BT-Series Breathing Tube, 3M™ Versaflo™ TR-300 Series
PAPR
Features
Respiratory Accessory
Material
Nomex
Product Color
Black
Product Series
BT Series
Product Type
Breathing Tube

3M™ Versaflo™ Filter Cover TR-6800FC/37378(AAD), for TR-6820N Filter, 1 EA/Case

3M Product Number TR-6800FC 3M ID 7100021247

Details

- Easy to use
- Helps protect cartridge from physical damage
- Enables use of prefilters and/or spark arrestors
- Enables PAPR to be worn through decontamination showers or rain

Typical properties

- Battery Type
 - (4) "AA" Alkaline Cells
- Brands
 - Versaflo™
- Case Quantity
 - 1/case
- Compatible With
 - 3M™ Versaflo™ TR-600 Series PAPR
- Hazard Type
 - Silica
- Intrinsically Safe
 - Yes
- Net Weight (Metric)
 - 75 g
- Product Series
 - TR-600, TR-800
- Product Type
 - Filt

Dimensions and Classifications

- Overall Height (Metric)
 - 0.096 m
- Overall Length (Metric)
 - 0.261 m
- Overall Width (Metric)
 - 0.13 m

3M™ Versaflo™ Filter Cover TR-6300FC/37380 (AAD), for TR-6300 Series Cartridges, 1 EA/Case

3M Product Number TR-6300FC 3M ID 7100021336

Details

- Easy to use
- Helps protect cartridge from physical damage
- Enables use of prefilters and/or spark arrestors
- Enables PAPR to be worn through decontamination showers or rain

Typical properties

- Brands
 - Versaflo™
- Case Quantity
 - 1/case
- Compatible With
 - 3M™ Versaflo™ TR-600 Series PAPR
- Hazard Type
 - Silica
- Intrinsically Safe
 - Yes
- Net Weight (Metric)
 - 108 g
- Product Series
 - TR-600, TR-800
- Product Type
 - Filter Cover
- Recommended Application
 - Ass

Dimensions and Classifications

- Overall Height (Metric)
 - 0.12 m
- Overall Length (Metric)
 - 0.254 m
- Overall Width (Metric)
 - 0.12 m

3M™ Versaflo™ Filter Cover TR-6500FC, for TR-6500 Series Cartridges, 1 EA/Case

Part Number 37381 3M Product Number TR-6500FC 3M ID 7100021252

Details

- Easy to use
- Helps protect cartridge from physical damage
- Enables use of prefilters and/or spark arrestors
- Enables PAPR to be worn through decontamination showers or rain

Typical properties

- Brands
Versaflo™
- Case Quantity
1/case
- Compatible With
3M™ Versaflo™ TR-600 Series PAPR
- Hazard Type
Silica
- Intrinsically Safe
Yes
- Net Weight (Metric)
115 g
- Product Series
TR-600, TR-800
- Product Type
Filter Cover
- Recommended Application
Ass

Dimensions and Classifications

- Overall Height (Metric)
0.514 m
- Overall Length (Metric)
0.53 m
- Overall Width (Metric)
0.493 m

3M™ Cartridge Filter Holder 7586, 20 EA/Case

3M Product Number 7586 3M ID 7000002160 UPC 50051131527565

Details

Approved 3M replacement part
Designed for use with the 3M Half Facepiece Respirators 7501, 7502 and 7503
(sold separately)
Maintains original performance standards of facepiece
Includes two inhalation valves and one exhalation valve
Replaceable part can potentially result in respiratory equipment cost savings

Typical properties

Accessories
No
Boxes per Case
20
Brands
3M™
Case Quantity
20/case
Clip-on Welding Shield
No
Compatible Respirator
7500 Series
Compatible with 3M™ PAPR Systems
No
Compatible with 3M™ Supplied Air System
Yes
Compatible with Welding Shield
N

3M™ DBI-SALA® Confined Space Integrated Adjustable Barrel Mount Sleeve 8512285, Fits Up To 24 in

Part Number 8512285 3M Product Number 8512285 3M ID 7100260213

Details

- Integral screw-style fastening system
- Set up and dismantle with ease
- Welded aluminum construction
- Accommodates 27.5 in. (69.85 cm) offset davit masts
- Recommended for use in multiple industries
- Barrel moount sleeve bases can accommodate wall thicknesses of up to 12 in. (30.5 cm) or 24 in. (61 cm)

Typical properties

- Brands
 - Advanced™
- Case Quantity
 - 1
- Connected Safety ID Equipped
 - No
- Install Type
 - Portable
- Net Weight (Imperial)
 - 68 lb
- Net Weight (Metric)
 - 30.8 kg
- Product Series
 - Advanced™
- Recommended Industry
 - Construction, General Industrial, Mining, Oil & Gas

3M™ DBI-SALA® Vacuum Anchor Lifeline System Secondary Pad Vacuum Anchor 2200109

Part Number 2200109 3M Product Number 2200109 3M ID 7100226832

Details

- Compact and lightweight aluminum design is easy to transport, install, and use
- Provides a secure tie-off point on smooth, non-porous surfaces using vacuum technology
- Approved for horizontal lifeline use
- Heavy-duty storage and transport case
- Secondary vacuum anchor pad for aviation industry vacuum anchor lifeline system
- Attaches to primary pad unit with air hose (model 2200130)
- Audible and visual alarms for complete safety
- Built-in check valves provide safety during accidental air loss
- Rubber seals won't damage surface when installed as defined in the user instruction manual

Typical properties

- Anchor Install Type
 - Reusable
- Brands
 - DBI-SALA®
- Case Quantity
 - 1
- Connected Safety ID Equipped
 - Yes
- For Use With
 - Aviation Industry Use
- Net Weight (Imperial)
 - 51.5 lb
- Net Weight (Metric)
 - 23.4 kg
- Product Color
 - Black, Silver
- Product Series
 - Mobi-Lo

3M™ DBI-SALA® Vacuum Anchor Lifeline System Secondary Pad 2200096

Part Number 2200096 3M Product Number 2200096 3M ID 7100228412

Details

Compact and lightweight aluminum design is easy to transport, install, and use
Provides a secure tie-off point on smooth, non-porous surfaces using vacuum technology
Approved for horizontal lifeline use
Heavy-duty storage and transport case
Secondary vacuum anchor pad for aviation industry vacuum anchor lifeline system
Attaches to primary pad unit with air hose (model 2200130)
Audible and visual alarms for complete safety
Built-in check valves provide safety during accidental air loss
Rubber seals won't damage surface when installed as defined in the user instruction manual

Typical properties

Anchor Install Type
Reusable
Brands
DBI-SALA®
Case Quantity
1
Connected Safety ID Equipped
Yes
For Use With
General Industry Use
Product Color
Black, Silver
Product Series
Mobi-Lok™
Product Type
Secondary Pad Vacuum Anchor - General Industr

3M™ Virtua™ CCS Protective Eyewear with Foam Gasket, VC220AF Clear +2.0D Anti-Fog Lens, 20 ea/Case

3M Product Number VC220AF 3M ID 7100046672 UPC 10078371662704

Typical properties

ANSI Requirements

ANSI Z87.1-2003 and CSA Z94.3-2007

Anti Fog Lens

Yes

Brands

Virtua™

Case Quantity

20

Class

Premium

Comfort Features

Color-accented temples, Comfortable Wraparound Frame, Contains Foam Gasket, Cord Control System, Sporty wrapar

Dimensions and Classifications

Overall Height (Imperial)

9.25 in

Overall Height (Metric)

23.495 cm

Overall Length (Imperial)

9.25 in

Overall Length (Metric)

23.495 cm

Overall Width (Imperial)

4.5 in

Overall Width (Metric)

11.43 cm

3M™ Speedglas™ Silver Front Panel 9100XXi, Welding Safety 06-0300-55i 1 EA/Case

3M ID 7010386337 UPC 00051141563282

Typical properties

Brands
Speedglas™
Compatible Welding Helmet
9100 Series
Headgear Type
Faceshields
Material
Polycarbonate
Product Color
Silver
Product Series
9100XXi
eClass 14 Classification Group
40300190

3M™ Speedglas™ G5-02 Welding Helmet Front Cover 08-0700-63, 1 ea

Part Number 08-0700-63 3M Product Number 08-0700-63 3M ID 7100239739

Details

Replacement front cover if the original becomes damaged or worn
Spare part front cover for the 3M™ Speedglas™ Welding Helmet G5-02
For maximum safety and comfort, make it a habit to check your equipment regularly

Typical properties

Brands
Speedglas™
Case Quantity
1/Case
Compatible Welding Helmet
G5-02 Welding Helmets
For Use With
G5-02 Welding Helmets
Product Series
G5
Product Type
Cover Plate
Recommended Application
Welding
Recommended Industry
Construction, General

3M™ Speedglas™ 9100 FX/9100 FX-Air Wide-View Grinding Visor Frame 06-0700-64, Black, 1 EA/Case

3M Product Number 06-0700-64 3M ID 7100089205 UPC 00051141564012

Details

Grinding Visor Frame
9100FX/9100 FX-Air
Replacement Part

Typical properties

Brands
Speedglas™
Case Quantity
1
Compatible Welding Helmet
9100 FX Welding Helmets, 9100 FX-Air Welding Helmets
For Use With
3M™ Speedglas™ 9100FX-Air Welding Helmets
Graphic Theme
Black
Headgear Type
Grinding Visor
Product Color
Black
Prod

3M™ Speedglas™ 9100 FX/9100 FX-Air Front Panel 06-0700-63, Chrome, 1 EA/Case

3M Product Number 06-0700-63 3M ID 7000128084 UPC 00051131496798

Details

Front Frame

Replacement Part

Replace worn out or damaged parts, if any pits, scratches or damages occur

For use with 3M™ Speedglas™ Welding Helmets

Typical properties

Brands

Speedglas™

Case Quantity

1

Compatible Welding Helmet

9100 FX Welding Helmets, 9100 FX-Air Welding Helmets

Features

9100 Series Accessory

For Use With

3M™ Speedglas™ 9100MP Welding Helmets

Headgear Type

Faceshields

Product Series

9100,

3M™ Speedglas™ G5-01 Battery Holder, 44-0400-55, 1 EA/Case

3M Product Number 44-0400-55 3M ID 7100214393 UPC 00076308944834

Details

Spare part to the Speedglas welding filter series G5-01
For use if the original battery holder becomes worn or damaged during use
For maximum safety and comfort, make it a habit to check your equipment regularly
Replace worn out or damaged parts

Typical properties

Brands
Speedglas™
Compatible Welding Helmet
G5-01 Welding Helmets
Product Color
Black
Product Series
G5
Product Type
Battery Holder
Recommended Application
Grinding, Metal Processing, Metal Repair, Welding
Recommended Industry
General Manufac

3M™ Solus™ 1000 Series S1000-CASE, Carrying Case, 10 ea/Box

3M Product Number S1000-CASE 3M ID 7100228822 UPC 50638060429483

Details

Hard shell protective eyewear carrying case helps provide protection to lenses and temples
Zipper eyeglass carrying case with soft interior lining helps prevent lens scratching
Belt loop mounting option for quick access to protective eyewear
Convenient drain holes

Typical properties

Brands

Solus™

Case Quantity

10

Product Series

1000

Product Type

Carrying Case

Recommended Application

Assembly, Automotive, Aviation, Chemical Handling, Chemicals, Chiseling, Construction, Demolition, Drilling, Facility Maintenance, Food & Beverage

3M™ DBI-SALA® Pass-Thru Web Concrete Strap Anchor with D-ring 2100088, Polyester, 2 ft

Part Number 2100088 3M Product Number 2100088 3M ID 7012818244

Details

Available in different lengths for jobsite versatility
Do not use anchorage until it is embedded in cured concrete
Compatible with various fall arrest systems
Features high-strength steel hardware
Economical disposable design
Meets the requirements for ANSI Z359.18, OSHA 1910.140 and OSHA 1926.502
Recommended for use in construction and mining industries

Typical properties

Anchor Install Type
Permanent
Attachment Type
Pass-through/Choker
Brands
DBI-SALA®
Case Quantity
1
Connected Safety ID Equipped
No
Install Type
Disposable
Material
Polyester Web
Product Color
Blue
Product Type
Concrete Anchor Strap
Recom

Dimensions and Classifications

Overall Length (Imperial)
24 in

3M™ DBI-SALA® Pass-Thru Web Concrete Strap Anchor with D-ring 2100052, Polyester, 8 ft

Part Number 2100052 3M Product Number 2100052 3M ID 7012818236

Details

Available in different lengths for jobsite versatility
Do not use anchorage until it is embedded in cured concrete
Compatible with various fall arrest systems
Features high-strength steel hardware
Economical disposable design
Meets the requirements for ANSI Z359.18, OSHA 1910.140 and OSHA 1926.502
Recommended for use in construction and mining industries

Typical properties

Anchor Install Type
Permanent
Attachment Type
Pass-through/Choker
Brands
DBI-SALA®
Case Quantity
1
Connected Safety ID Equipped
No
Install Type
Disposable
Material
Polyester Web
Product Color
Blue
Product Type
Concrete Anchor Strap
Recom

Dimensions and Classifications

Overall Length (Imperial)
96 in

3M™ DBI-SALA® Pass-Thru Web Concrete Strap Anchor with D-ring 2100054, Polyester, 5 ft

Part Number 2100054 3M Product Number 2100054 3M ID 7012818238

Details

Available in different lengths for jobsite versatility
Do not use anchorage until it is embedded in cured concrete
Compatible with various fall arrest systems
Features high-strength steel hardware
Economical disposable design
Meets the requirements for ANSI Z359.18, OSHA 1910.140 and OSHA 1926.502
Recommended for use in construction and mining industries

Typical properties

Anchor Install Type
Permanent
Attachment Type
Pass-through/Choker
Brands
DBI-SALA®
Case Quantity
1
Connected Safety ID Equipped
No
Install Type
Disposable
Material
Polyester Web
Product Color
Blue
Product Type
Concrete Anchor Strap
Recom

Dimensions and Classifications

Overall Length (Imperial)
60 in

3M™ DBI-SALA® Pass-Thru Web Concrete Strap Anchor with D-Ring 2100050, Polyester, 3.5 ft

Part Number 2100050 3M Product Number 2100050 3M ID 7100260185

Details

Available in different lengths for jobsite versatility
Do not use anchorage until it is embedded in cured concrete
Compatible with various fall arrest systems
Features high-strength steel hardware
Economical disposable design
Meets the requirements for ANSI Z359.18, OSHA 1910.140 and OSHA 1926.502
Recommended for use in construction and mining industries

Typical properties

Anchor Install Type
Permanent
Attachment Type
Pass-through/Choker
Brands
DBI-SALA®
Case Quantity
1
Connected Safety ID Equipped
No
Install Type
Disposable
Material
Polyester Web
Product Color
Blue
Product Type
Concrete Anchor Strap
Recom

Dimensions and Classifications

Overall Length (Imperial)
42 in

3M™ DBI-SALA® Concrete Anchor Strap 2100053

Part Number 2100053 3M Product Number 2100053 3M ID 7100232041

Details

Available in different lengths for jobsite versatility
Do not use anchorage until it is embedded in cured concrete
Compatible with various fall arrest systems
Features high-strength steel hardware
Economical disposable design
Meets the requirements for ANSI Z359.18, OSHA 1910.140 and OSHA 1926.502
Recommended for use in construction and mining industries

Typical properties

Anchor Install Type
Permanent
Attachment Type
Pass-through/Choker
Brands
DBI-SALA®
Case Quantity
1
Connected Safety ID Equipped
No
Install Type
Disposable
Material
Polyester Web
Product Color
Blue
Product Type
Concrete Anchor Strap
Recom

Dimensions and Classifications

Overall Length (Imperial)
48 in

3M™ DBI-SALA® Pass-Thru Web Concrete Strap Anchor with D-ring 2100058, Polyester, 10 ft

Part Number 2100058 3M Product Number 2100058 3M ID 7012818240

Details

Available in different lengths for jobsite versatility
Do not use anchorage until it is embedded in cured concrete
Compatible with various fall arrest systems
Features high-strength steel hardware
Economical disposable design
Meets the requirements for ANSI Z359.18, OSHA 1910.140 and OSHA 1926.502
Recommended for use in construction and mining industries

Typical properties

Anchor Install Type
Permanent
Attachment Type
Pass-through/Choker
Brands
DBI-SALA®
Case Quantity
1
Connected Safety ID Equipped
No
Install Type
Disposable
Material
Polyester Web
Product Color
Blue
Product Type
Concrete Anchor Strap
Recom

Dimensions and Classifications

Overall Length (Imperial)
120 in

3M™ DBI-SALA® Concrete D-ring Anchor, 5 Extra Bolts 2104561, 1 pack

Part Number 2104561 3M Product Number 2104561 3M ID 7100217043

Details

- High strength construction
- Compact and lightweight design
- Rugged and corrosion resistant
- Installs into 11/16 in., 18 mm or 3/4 in. concrete hole
- Use vertically in wall or horizontally in ceiling
- Install as temporary or permanent anchor
- Reusable D-ring assembly - extra bolts available separately
- Safe hook-up indicator
- Swiveling D-ring tie-off point

Typical properties

- Anchor Install Type
 - Permanent & Reusable
- Attachment Type
 - Screw
- Brands
 - DBI-SALA®
- Case Quantity
 - 1
- Connected Safety ID Equipped
 - No
- Dimensions
 - 5.70x3.00x4.40in
- Install Type
 - Reusable or Permanent
- Material
 - Zinc Plated Steel
- Product Color
 - Silver

3M™ DBI-SALA® Concrete D-ring Anchor 2104560, 1 EA

Part Number 2104560 3M Product Number 2104560 3M ID 7100188834

Details

- High strength construction
- Compact and lightweight design
- Rugged and corrosion resistant
- Installs into 11/16 in., 18 mm or 3/4 in. concrete hole
- Use vertically in wall or horizontally in ceiling
- Install as temporary or permanent anchor
- Reusable D-ring assembly - extra bolts available separately
- Safe hook-up indicator
- Swiveling D-ring tie-off point

Typical properties

- Anchor Install Type
 - Permanent & Reusable
- Attachment Type
 - Screw
- Brands
 - DBI-SALA®
- Case Quantity
 - 1
- Connected Safety ID Equipped
 - No
- Install Type
 - Reusable or Permanent
- Material
 - Zinc Plated Steel
- Product Color
 - Silver
- Product Type
 - Concrete D-rin

3M™ DBI-SALA® D-ring Bolt Anchor For Concrete 2104562, 11 Extra Bolts, Fits 11/16 in, 18 mm or 3/4 in Hole

Part Number 2104562 3M Product Number 2104562 3M ID 7012818329

Details

- High strength construction
- Compact and lightweight design
- Rugged and corrosion resistant
- Installs into 11/16 in., 18 mm or 3/4 in. concrete hole
- Use vertically in wall or horizontally in ceiling
- Install as temporary or permanent anchor
- Reusable D-ring assembly - extra bolts available separately
- Safe hook-up indicator
- Swiveling D-ring tie-off point

Typical properties

- Anchor Install Type
 - Permanent & Reusable
- Attachment Type
 - Screw
- Brands
 - DBI-SALA®
- Case Quantity
 - 1
- Connected Safety ID Equipped
 - No
- Dimensions
 - 5.70x3.00x4.40in
- Install Type
 - Reusable or Permanent
- Material
 - Zinc Plated Steel
- Product Color
 - Silver

3M™ DBI-SALA® D-ring Bolt Anchor For Concrete 2104563, 1 Extra Bolts, Fits 11/16 in, 18 mm or 3/4 in Hole

Part Number 2104563 3M Product Number 2104563 3M ID 7012818330

Details

- High strength construction
- Compact and lightweight design
- Rugged and corrosion resistant
- Installs into 11/16 in., 18 mm or 3/4 in. concrete hole
- Use vertically in wall or horizontally in ceiling
- Install as temporary or permanent anchor
- Reusable D-ring assembly - extra bolts available separately
- Safe hook-up indicator
- Swiveling D-ring tie-off point

Typical properties

- Anchor Install Type
 - Permanent & Reusable
- Attachment Type
 - Screw
- Brands
 - DBI-SALA®
- Case Quantity
 - 1
- Connected Safety ID Equipped
 - No
- Dimensions
 - 5.70x3.00x4.40in
- Install Type
 - Reusable or Permanent
- Material
 - Zinc Plated Steel
- Product Color
 - Silver

3M™ Speedglas™ 9100 QR w Rail only, 06-0300-54QR, 1 EA/CASE

3M Product Number 06-0300-54QR 3M ID 7100200569 UPC 00076308943752

Details

9100 QR Assembly
No Hard Hat Included
No ADF Included
Hard hat and ADF sold separately

Typical properties

ADF Model
None
Brands
Speedglas™
Case Quantity
1
Features
Hard Top
Graphic Theme
Black
Headgear Type
Welding Helmet
Includes
Rail
Lens Type
No Lens
Product Color
Black
Product Series
9100
Recommended Application
Assembly, Facility Mai

3M™ DBI-SALA® Vacuum Anchor Lifeline System without Air Bottle Attachment 2200094

Part Number 2200094 3M Product Number 2200094 3M ID 7100228430

Details

- Compact and lightweight aluminum design is easy to transport, install, and use
- Provides a secure tie-off point on smooth, non-porous surfaces using vacuum technology
- Approved for horizontal lifeline use
- Heavy-duty storage and transport case
- Compatible with external air power sources for added versatility
- Self-contained design includes on-board air bottle. Compatible with external air power options
- Comprehensive backup system features an audio alarm and vacuum-level indicator
- Built-in check valves provide safety during accidental air loss
- Aviation-rated, intrinsically safe electronics
- Meets the requirements for 29 CFR OSHA 1910.140, OSHA 1926.502
- Can provide power for one additional secondary unit

Typical properties

- Anchor Install Type
- Reusable
- Attachment Type
- Vacuum
- Brands
- DBI-SALA®
- Case Quantity
- 1
- Connected Safety ID Equipped
- Yes
- Dimensions
- 22.00x22.00x6.00in
- For Use With
- General Industry Use
- Install Type
- Reusable
- Product Series
- Mobi-Lok™
- Product

3M™ DBI-SALA® Vacuum Anchor with Air Bottle Attachment 2200095

Part Number 2200095 3M Product Number 2200095 3M ID 7100228431

Details

Compact and lightweight aluminum design is easy to transport, install, and use
Provides a secure tie-off point on smooth, non-porous surfaces using vacuum technology

Approved for horizontal lifeline use

Heavy-duty storage and transport case

Compatible with external air power sources for added versatility

Self-contained design includes on-board air bottle. Compatible with external air power options

Comprehensive backup system features an audio alarm and vacuum-level indicator

Built-in check valves provide safety during accidental air loss

Aviation-rated, intrinsically safe electronics

Meets the requirements for 29 CFR OSHA 1910.140, OSHA 1926.502

Can provide power for one additional secondary unit

Typical properties

Anchor Install Type

Reusable

Attachment Type

Vacuum

Brands

DBI-SALA®

Case Quantity

1

Connected Safety ID Equipped

Yes

Dimensions

22.00x22.00x6.00in

For Use With

General Industry Use

Install Type

Reusable

Product Series

Mobi-Lok™

Product

3M™ DBI-SALA® Aviation Self-Contained Vacuum Anchor with Air Bottle 2200108, Shop Air or Gas Powered

Part Number 2200122 3M Product Number 2200122 3M ID 7100307766

Details

- Compact and lightweight aluminum design is easy to transport, install, and use
- Provides a secure tie-off point on smooth, non-porous surfaces using vacuum technology
- Approved for horizontal lifeline use
- Heavy-duty storage and transport case
- Compatible with external air power sources for added versatility
- Self-contained design includes on-board air bottle. Compatible with external air power options
- Comprehensive backup system features an audio alarm and vacuum-level indicator
- Built-in check valves provide safety during accidental air loss
- Aviation-rated, intrinsically safe electronics
- Meets the requirements for 29 CFR OSHA 1910.140, OSHA 1926.502
- Can provide power for one additional secondary unit

Typical properties

- Anchor Install Type
 - Reusable
- Attachment Type
 - Vacuum
- Brands
 - DBI-SALA®
- Case Quantity
 - 1
- Connected Safety ID Equipped
 - Yes
- Dimensions
 - 22.00x22.00x6.00in
- For Use With
 - Aviation Industry Use
- Install Type
 - Reusable
- Product Series
 - Mobi-Lok™
- Product

3M™ DBI-SALA® Vacuum Anchor Lifeline System without Air Bottle Attachment 2200107

Part Number 2200107 3M Product Number 2200107 3M ID 7100228423

Details

- Compact and lightweight aluminum design is easy to transport, install, and use
- Provides a secure tie-off point on smooth, non-porous surfaces using vacuum technology
- Approved for horizontal lifeline use
- Heavy-duty storage and transport case
- Compatible with external air power sources for added versatility
- Self-contained design includes on-board air bottle. Compatible with external air power options
- Comprehensive backup system features an audio alarm and vacuum-level indicator
- Built-in check valves provide safety during accidental air loss
- Aviation-rated, intrinsically safe electronics
- Meets the requirements for 29 CFR OSHA 1910.140, OSHA 1926.502
- Can provide power for one additional secondary unit

Typical properties

- Anchor Install Type
- Reusable
- Attachment Type
- Vacuum
- Brands
- DBI-SALA®
- Case Quantity
- 1
- Connected Safety ID Equipped
- Yes
- For Use With
- Aviation Industry Use
- Install Type
- Reusable
- Product Series
- Mobi-Lok™
- Product Type
- Vacuum Anchor without Air

3M™ DBI-SALA® D-ring with Anchorage Plate 2101630, 1 EA

Part Number 2101630 3M Product Number 2101630 3M ID 7100188830

Details

- High strength construction
- Compact and lightweight design
- Rugged and corrosion resistant
- Bolt or weld to structure for fall arrest anchor point
- Compact steel plate
- Pre-drilled holes
- Zinc plated and Stainless Steel D-ring for compatible tie-off point

Typical properties

- Anchor Install Type
Permanent
- Attachment Type
Bolt/Weld
- Brands
DBI-SALA®
- Case Quantity
1
- Connected Safety ID Equipped
No
- Install Type
Permanent
- Material
Zinc Plated Steel
- Product Color
Silver, Yellow Zinc
- Product Type
D-ring with Anchorag

3M™ DBI-SALA® D-ring Anchorage Plate 2101632, 1 EA

Part Number 2101632 3M Product Number 2101632 3M ID 7100217032

Details

- High strength construction
- Compact and lightweight design
- Rugged and corrosion resistant
- Bolt or weld to structure for fall arrest anchor point
- Compact steel plate
- Pre-drilled holes
- Zinc plated and Stainless Steel D-ring for compatible tie-off point

Typical properties

- Anchor Install Type
Permanent
- Attachment Type
Bolt/Weld
- Brands
DBI-SALA®
- Case Quantity
1
- Connected Safety ID Equipped
No
- Dimensions
0.25x2.00x4.50in
- Install Type
Permanent
- Material
Zinc Plated Steel
- Product Color
Black, Yellow Zinc
- Produ

3M™ DBI-SALA® D-ring Anchorage Plate 2101638, 1 ea

Part Number 2101638 3M Product Number 2101638 3M ID 7100217031

Details

- High strength construction
- Compact and lightweight design
- Rugged and corrosion resistant
- Bolt or weld to structure for fall arrest anchor point
- Compact steel plate
- Pre-drilled holes
- Zinc plated and Stainless Steel D-ring for compatible tie-off point

Typical properties

- Anchor Install Type
 - Permanent
- Attachment Type
 - Bolt/Weld
- Brands
 - DBI-SALA®
- Case Quantity
 - 1
- Connected Safety ID Equipped
 - No
- Dimensions
 - 0.25x2.00x4.50in
- Install Type
 - Permanent
- Material
 - Zinc Plated Steel
- Product Color
 - Silver
- Product Type
 - D-r

3M™ DBI-SALA® Beam Trolley 2103143, 1 EA

Part Number 2103143 3M Product Number 2103143 3M ID 7100188831

Details

Compatible with various fall protection systems

Compact, lightweight design

Ideal for use with personal fall arrest systems with self-retracting lifelines

Recommended for use in the construction, general industrial, mining, oil and gas, transportation, utilities, and wind energy industries

Portable and reusable

Corrosion-resistant construction for durability

This safety equipment is designed for use with additional personal protective equipment (PPE)

Installs onto 3 in. to 8 in. (7.6 - 20.3 cm.) wide and up to 11/16 in. (1.7 cm.) thick I-beam flange and attaches anywhere on a horizontal beam with complete horizontal mobility and a hands-free design

Fixed rotating D-ring mounts in the center for better weight distribution

Rotating D-ring tie-off point is fixed in center

Typical properties

Anchor Install Type

Permanent & Reusable

Anchor Type

I-Beam

Attachment Type

Clamp

Brands

DBI-SALA®

Case Quantity

1

Connected Safety ID Equipped

Yes

Fits Ibeam Flange Width

3 to 8 in. (7.6-20.3cm), 76 - 203mm

For Use With

3M™ DBI-SALA® Secur

3M™ DBI-SALA® Confined Space 4-in-1 Davit Guard System 8530352, 1 EA

Part Number 8530352 3M Product Number 8530352 3M ID 7100204296

Details

- Integrated 5,000 lb. (22 kN) mast anchorage point
- Fall arrest rated in all davit offset mast positions
- Built in pulley for 3-way SRL with emergency retrieval or winch
- The 3-way SRL with emergency retrieval or winch attach easily to mounting bracket
- Built-in secondary fall arrest anchor point
- Folding base and handrail
- Adjustable leveling system
- Set up and dismantle without tools
- Corrosion-resistant construction
- Built-in handrail system with hinged gate
- Recommended for use in all industries
- Built-in guardrail system with hinged gate
- Telescoping upper davit mast

Typical properties

- Brands
DBI-SALA®
- Case Quantity
1
- Connected Safety ID Equipped
No
- Install Type
Portable
- Net Weight (Imperial)
125 lb
- Net Weight (Metric)
56.7 kg
- Product Color
Green
- Product Type
4-in-1 Davit Guard System
- Recommended Industry
Construction,

3M™ DBI-SALA® Confined Space Portable Extendable Pole Hoist 8560409, Stainless Steel Hardware, 4 ft - 7 ft

3M Product Number 8560409 3M ID 7100311854

Details

Available in extensions of 4 ft.–7 ft. (1.2 m–2.1 m) or 6 ft.–10 ft. (1.8 m–3 m)

Built in pulley for 3-way SRL with emergency retrieval or winch

Swivel head rotates 360 degrees

The 3-way SRL with emergency retrieval or winch attach easily to mounting bracket

T-bar for added stability

Durable construction

Set up and dismantle without tools

Typical properties

Brands

DBI-SALA®

Case Quantity

1

Connected Safety ID Equipped

No

For Entry Type

Horizontal & Vertical

Install Type

Portable

Material

Aluminum

Maximum Arm Length (Imperial)

7 ft

Maximum Arm Length (Metric)

2.1 m

Minimum Arm Length (Imperial)

3M™ DBI-SALA® Rescue Rope Grab For Web 5000032, Stainless Steel

3M Product Number 5000032 3M ID 7100316906

Details

A web grab that can be used to facilitate a rescue from the crown, monkey board, ladder or other work locations on the structure

Typical properties

Brands
DBI-SALA®
Descent Type
Vertical
For Use With
Rescue & Descent Devices
Maximum Number of Users
One
Net Weight (Imperial)
0.8 lb
Net Weight (Metric)
0.36 kg
Product Color
Yellow
Product Series
Rollgliss™ R550
Product Type
Web Grab
R

Dimensions and Classifications

Overall Length (Imperial)
2.8 ft
Overall Length (Metric)
0.853 m

3M™ Versaflo™ Cleaning & Storage Kit BT-953, for BT-63/64 Breathing Tubes 1/case

3M Product Number BT-953 3M ID 7100176699 UPC 00051131277557

Details

Enables BT-63/64 Breathing Tubes to be submerged for cleaning
Helps protect BT-63/64 Breathing Tubes from internal contamination during cleaning
Helps protect BT-63/64 Breathing Tubes from internal contamination during storage

Typical properties

Brands
Versaflo™
Cartridge or Filter Included
No
Clip-on Welding Shield
No
Compatible Respirator Type
PAPR
Compatible With
3M™ Versaflo™ TR-600 Series PAPR
Enhanced Comfort
No
Enhanced Durability
No
Eye Protection
No
Intrinsically Safe
No

3M™ DBI-SALA® Sealed-Blok™ Assisted Rescue Pole/Tool for RSQ Self-Retracting Lifeline 3500202, 8 - 16 ft

Part Number 3500202 3M Product Number 3500202 3M ID 7100239633

Details

First-Man-Up™ pole with RSQ assisted rescue tool
Designed for Sealed-Blok™ with RSQ feature
8 ft. to 16 ft. (2.4-4.9 m) adjustable pole
Aluminum assisted rescue tool
Durable fiberglass and aluminum construction
Compact and lightweight design
Retrieval Winch (optional)
5 mm diameter rope
1633 kg Gate
RSQ Options
Cable lifeline replacement system

Typical properties

Brands
DBI-SALA®
Case Quantity
1
Connected Safety ID Equipped
No
For Use With
SRL
Product Color
Silver, Yellow
Product Series
Sealed-Blok™
Product Type
Assisted Rescue Tool
Recommended Industry
Construction, General Industrial, Mining, Oil

Dimensions and Classifications

Overall Length (Imperial)
8 ft
Overall Length (Metric)
203 mm

3M™ DBI-SALA® SecuraSpan™ Rebar/Shear Stud HLL Tie-Back Base with Chain

7400214, 1 ea

Part Number 7400214 3M Product Number 7400214 3M ID 7100220279

Details

Durable materials stand up to harsh conditions
Suitable for single and multi-span configurations
Single-span systems hold up to 2 workers; multi-span systems hold up to 6 workers
Top-mounted bolt and clamp adjustment system for safety and easy installation
Lightweight, portable design for easy transport
This safety equipment is intended for use with additional personal protective equipment (PPE)
Chain tie-back design is strong, secure, easy to install and adjust

Typical properties

Brands
DBI-SALA®
Case Quantity
1
Connected Safety ID Equipped
No
For Use With
3M™ DBI-SALA® SecuraSpan™ Rebar/Shear Stud HLL System
Install Type
Temporary/Portable
Lifeline Material
Order separately
Maximum Number of Workers
2 Per Span, 6 Tot

3M™ DBI-SALA® Confined Space Integrated Vehicle Hitch Mount Sleeve Extension Tube 8514503, Zinc Plated Steel, 2 ft

Part Number 8514503 3M Product Number 8514503 3M ID 7012820657

Details

Vehicle hitch mount sleeve extensions available in 2, 4, or 6 ft
Provides an extension for the vehicle hitch mount sleeve davit base
Durable construction
Set up and dismantle without tools
Recommended for use in many industries
Installs into 2-in. vehicle receiver hitch

Typical properties

Brands
DBI-SALA®
Case Quantity
1
Connected Safety ID Equipped
No
Dimensions
24.00x2.50x2.50in
Install Type
Portable
Recommended Industry
Construction, General Industrial, Mining, Oil & Gas, Transportation
Weight (Imperial)
17.6 lb.
Weight (M

3M™ DBI-SALA® Confined Space Integrated Vehicle Hitch Mount Sleeve Extension Tube 8511384, Zinc Plated Steel, 6 ft

Part Number 8511384 3M Product Number 8511384 3M ID 7012820549

Details

Vehicle hitch mount sleeve extensions available in 2, 4, or 6 ft
Provides an extension for the vehicle hitch mount sleeve davit base
Durable construction
Set up and dismantle without tools
Recommended for use in many industries
Installs into 2-in. vehicle receiver hitch

Typical properties

Brands

DBI-SALA®

Case Quantity

1

Connected Safety ID Equipped

No

Dimensions

72.00x2.50x2.50in

Install Type

Portable

Recommended Industry

Construction, General Industrial, Mining, Oil & Gas, Transportation

Weight (Imperial)

39 lb.

Weight (Met

3M™ DBI-SALA® Confined Space Integrated Vehicle Hitch Mount Sleeve Extension Tube 8512829, Zinc Plated Steel, 4 ft

Part Number 8512829 3M Product Number 8512829 3M ID 7012820615

Details

Vehicle hitch mount sleeve extensions available in 2, 4, or 6 ft
Provides an extension for the vehicle hitch mount sleeve davit base
Durable construction
Set up and dismantle without tools
Recommended for use in many industries
Installs into 2-in. vehicle receiver hitch

Typical properties

Brands

DBI-SALA®

Case Quantity

1

Connected Safety ID Equipped

No

Dimensions

48.00x2.50x2.50in

Install Type

Portable

Recommended Industry

Construction, General Industrial, Mining, Oil & Gas, Transportation

Weight (Imperial)

27.8 lb.

Weight (M

3M™ DBI-SALA® Confined Space Integrated Tank Flange Davit Mast Base 8520267, Fits 18 - 36 in dia

Part Number 8520267 3M Product Number 8520267 3M ID 7100244490

Details

Attaches to a horizontal flange face with three bolts
Pivoting arms accommodate flanges with a bolt circle diameter of 18 in. to 36 in. (35.7 cm to 91.4 cm) and width of 1 in. (2.5 cm)
Set up and dismantle with standard tools
Durable aluminum construction
Recommended for use in all industries
PVC davit mast sleeve liner
Set-up and dismantle with standard tools
Lightweight, corrosion resistant aluminum construction
Accommodates various davit arm heights

Typical properties

Brands
DBI-SALA®
Case Quantity
1
Connected Safety ID Equipped
No
Dimensions
(24.62x23.88x11.38)in
Install Type
Portable
Net Weight (Imperial)
61 lb
Net Weight (Metric)
27.7 kg
Product Color
Silver
Product Type
Tank Flange Davit Mast
Reco

3M™ Secure Click™ Quantitative Fit Test Adapter Kit HF-800-03, 1 EA/Case

3M Product Number HF-800-03 3M ID 7100181558 UPC 04054596622012

Details

Use to conduct quantitative fit testing on 3M™ Secure Click™ Half Facepiece Respirators HF-800 Series

Includes head harness assembly and fit test adapter with port
HF-800 Series facepieces and Secure Click™ cartridges and filters are not included

For workplace/occupational use only

Package contents: 1 case contains 1 kit

Typical properties

Accessories

Yes

Brands

Secure Click™

Case Quantity

1/Bag

Clip-on Welding Shield

No

Compatible with 3M™ PAPR Systems

No

Compatible with 3M™ Supplied Air System

No

Enhanced Comfort

No

For Use With

3M™ Secure Click™ HF-800 Series Reusable Resp

Dimensions and Classifications

Overall Height (Metric)

121 mm

Overall Length (Metric)

43.4 mm

Overall Width (Metric)

124.7 mm

3M™ Secure Click™ Quantitative Fit Test Adapter Kit FF-800-06, 1 ea/Case

3M Product Number FF-800-06 3M ID 7100265593 UPC 00638060432266

Details

Use to conduct quantitative fit testing on 3M™ Secure Click™ Full Facepiece Respirators FF-800 Series

FF-800 Series facepieces and Secure Click™ cartridges and filters are not included

For workplace/occupational use only

Typical properties

Accessories

Yes

Brands

Secure Click™

Case Quantity

1

Compatible With

3M™ Secure Click™ FF-800 Series Reusable Respirators

Compatible with 3M™ PAPR Systems

No

Compatible with 3M™ Supplied Air System

No

Net Weight (Imperial)

0.019 lb

Net Weigh

Dimensions and Classifications

Overall Height (Imperial)

0.88 in

Overall Height (Metric)

22.347 mm

Overall Length (Imperial)

1.521 in

Overall Length (Metric)

38.65 mm

Overall Width (Imperial)

1.521 in

Overall Width (Metric)

38.65 mm

3M™ DBI-SALA® Lad-Saf™ Flexible Counterweight 5901583, 1 ea

Part Number 5901583 3M Product Number 5901583 3M ID 7100220276

Details

6 lbs. (2.7 kg) flexible counterweight to keep lifeline taut
Heavy-duty nylon construction
Built-in web loop for easy attachment to lifeline
Compact and portable design

Typical properties

Brands
DBI-SALA®
Case Quantity
1
Connected Safety ID Equipped
No
Dimensions
(6.00x3.00x12.00)in
For Use With
Rope Lifelines
Net Weight (Metric)
2.7 kg
Product Color
Black
Product Series
Lad-Saf™
Product Type
Flexible Counterweight
Recomm

3M™ E-A-R™ One Touch™ Pro Earplug Dispenser, Blue 391-0000

3M Product Number 391-0000 3M ID 7100064963 UPC 00078371668037

Details

Dispenser makes it easy for workers to access earplugs
A simple turn of the hand drops earplug into a worker's hand one at a time
Drained catch tray, wind side shields and durable plastic construction safeguards earplugs in outdoor locations
Versatile design allows for placing on countertops or wall mounting
Bulk style dispenser eliminates waste from individually wrapped earplugs
Accepts 8 different 3M™ Earplugs in refill bottles
Refill bottle not included

Typical properties

Brands
E-A-R™
Case Quantity
1
Corded
No
Dielectric
No
Hearing Protection Style
Dispenser
Material
ABS
Metal Detectable
No
Moisture Resistant
Yes
Product Code
391-0000
Product Color
Blue
Product Series
One Touch
Product Type
Dispense

3M™ PELTOR™ CH-5 High Attenuation Headset - MT73H450A-77 GB - Flex Connector - Headband - 31dB NRR

3M Product Number MT73H450A-77 GB 3M ID 7100099844 UPC 07318640067059

Details

Professional Hearing Protection with one of the Highest NRR values on the market (NRR 31dB)

High visibility color provide increased safety in exposed environments

Designed by 3M PELTOR and built tough for the working professional

Noise attenuating ear cups help provide hearing protection in environments with extreme hazardous noise

The Flex connector offers a wide range of options for customizing the headset to the radios available on the market

Typical properties

Attenuation Rating

31 dB

Audio Type

Communication

Auxiliary Port

Flex

Bluetooth

No

Brands

PELTOR™

Built In FM and or AM Radio

No

Built in 2-Way Radio

No

Case Quantity

1

Communication Direction

Two-way

Communication Type

Two-way Radio

C

3M™ DBI-SALA® Coated Web Scaffold Choker Anchor 1201422, Polyester, 2 ft

Part Number 1201422 3M Product Number 1201422 3M ID 7012816943

Details

Lightweight and durable polyester web construction
Meets the requirements for 29 CFR OSHA 1910.140, and OSHA 1926.502
Recommended for use in multiple industries including construction, mining, oil and gas, transportation, utilities, and wind energy
Adjustable designs available to accommodate a variety of different sized structures
Compatible with various fall arrest systems
This safety equipment is designed for use with additional personal fall arrest systems
Features high-strength steel hardware
Portable and reusable
Ideal anchorage device for scaffolding or piping

Typical properties

Anchor Install Type
Reusable
Attachment Type
Pass-through/Choker
Brands
DBI-SALA®
Case Quantity
1
Connected Safety ID Equipped
No
Install Type
Reusable
Material
Polyester Web
Product Color
Yellow
Product Series
None
Product Type
Coated

Dimensions and Classifications

Overall Length (Imperial)
2 ft

3M™ DBI-SALA® Flexiguard™ Jib Counterweight Base with Concrete 8530566, Yellow, 5000 lb

Part Number 8530566 3M Product Number 8530566 3M ID 7100231986

Details

Counterweighted overhead rail fall protection system
Aluminum and steel construction
Complete hardware provided
Portable with use of a forklift
Includes four steel leveling jacks; built-in slope indicators available as option
Recommended for a variety of applications within the transportation, construction, utilities, and mining industries
Available in multiple sizes, both fixed and adjustable heights
One part of your fall protection system; intended for use with other personal protective equipment (PPE) including (but not limited to) harnesses and self-retracting lifelines
Specialized installation and training available

Typical properties

Brands
DBI-SALA®
Case Quantity
1
Connected Safety ID Equipped
No
Install Type
Temporary/Portable
Maximum Number of Users
One
Net Weight (Imperial)
5000 lb
Net Weight (Metric)
2268 kg
Product Color
Yellow Zinc
Product Series
FlexiGuard™
P

3M™ DBI-SALA® Nano-Lok™ Aerial Work Platform Personal Self-Retracting Lifeline 3101655, Web, 4.5 ft

Part Number 3101655 3M Product Number 3101655 3M ID 7012818760

Details

- Arc flash rated
- Built-in connector for single-leg SRL direct attachment to harness
- 4.5 ft. (1.4m) of 3/4" (19mm) Nomex®/Kevlar® fiber webbing
- Aluminum self-locking carabiner on lifeline
- Extremely compact, lightweight design
- Tough and impact resistant thermoplastic housing
- Swiveling connector interface
- Quick activating speed sensing brake system
- Integrated backpack style energy absorber with Kevlar® cover material
- 3M™ Connected Safety ID (CSID) equipped
- Variety of configurations available

Typical properties

- Anchor Connection Type
 - Carabiner
- Brands
 - DBI-SALA®
- Connected Safety ID Equipped
 - Yes
- Harness Connection Type
 - Built-in Connector
- Lifeline Hook Material
 - Aluminum and Zinc Plated Steel
- Lifeline Length (Imperial)
 - 4.5 ft
- Lifeline Length (Metric)
 - 1.4

Dimensions and Classifications

- Overall Length (Imperial)
 - 4.5 ft

3M™ DBI-SALA® Adjustable Web Positioning Lanyard for Nano-Lok™ SRL 1231075, 6 ft

Part Number 1231075 3M Product Number 1231075 3M ID 7012691245

Details

Designed to be used with 3M™ DBI-SALA® Nano-Lok™ Self Retracting Lifeline (ANSI or CSA models)
Abrasion resistant polyester webbing
Abrasion resistant polyester webbing
Integrated Nano-Lok™ twin leg connector at one end
Built-in wear indicator

Typical properties

Anchor Connection Type
Snap Hook
Anchor Hook Material
Zinc Plated Steel
Brands
DBI-SALA®
Case Quantity
1
Connected Safety ID Equipped
No
Energy Absorber Class
None
Harness Connection Hook Material
Zinc Plated Steel
Harness Connection Type
C

Dimensions and Classifications

Overall Length (Imperial)
6 ft

3M™ DBI-SALA® Lad-Saf™ Detachable Cable Traveller 6160030, 1 EA

Part Number 6160030 3M Product Number 6160030 3M ID 7100188818

Details

Sleeve/Traveler for 3M™ DBI-SALA® Lad-Saf™ 9.5 mm. (3/8 in.) and 8 mm. (5/16 in.) cable vertical safety system
Approved for use on galvanized or stainless steel 9.5 mm in.. (3/8 in.) and 8 mm. (5/16) cable vertical safety system
Mobile hands-free design helps follow the user for added climbing protection
Installs and detaches anywhere along the vertical lifeline
Dual-independent locking mechanism
Laser-cut stainless steel built-in energy absorber and fall indicator
Manufactured from stainless steel helping to resist corrosion in harsh conditions
Extremely rugged and corrosion resistant construction
Extremely compact, lightweight design

Typical properties

Attachment Type
None
Brands
DBI-SALA®
Carabiner/Hook Material
Zinc Plated Steel
Case Quantity
1
Connected Safety ID Equipped
Yes
Dimensions
4.7 in x 1.3 in x 6 in
Install Type
Temporary
Maximum Number of Users
One
Net Weight (Imperial)
2.

3M™ Protecta® Reusable Hinged Roof Anchor For Wood/Metal 2104000, with Fastener Kit

Part Number 2104000 3M Product Number 2104000 3M ID 7012818304

Details

Durable materials and hardware designed to help stand up to harsh working conditions
Compatible with various fall arrest systems, not compliant for use with Horizontal Lifelines
Suitable for use in general industrial and construction industries
Compact, lightweight design
Meets the requirements for 29 CFR OSHA 1910.140 and 29 CFR OSHA 1926.502
Features corrosion-resistant, steel and aluminum construction for durability
This safety equipment is designed for use with additional personal protective equipment (PPE)
Installs to sloped or flat wood and metal roofing
Low-profile design stays out of the way as you work
Fast and easy nail or screw installation - Fastener kit included
Hinged design with D-ring

Typical properties

Anchor Install Type
Reusable
Attachment Type
Nail/Screw
Brands
PROTECTA®
Connected Safety ID Equipped
No
Install Type
Reusable
Material
Zinc Plated Steel
Product Color
Yellow Zinc
Product Series
PRO™
Product Type
Reusable Hinged Roof Anch

3M™ DBI-SALA® Uni-Anchor with Tie-Off for Inclined Surface 8517413, 1/CV

Part Number 8517413 3M Product Number 8517413 3M ID 7100188844

Details

Designed for use with the 3M™ DBI-SALA® Confined Space Portable Fall Arrest Post

Welds to steel floors or structures

Weldable, Bare steel construction

Permanent installation with standard welding processes

Available with or without tie-off anchor point

Recommended for use in multiple industries

Suitable for fall protection in electrical transformer applications

Typical properties

Anchor Install Type

Permanent

Brands

DBI-SALA®

Material

Steel

Product Series

Advanced™

Weight Capacity (Imperial)

310 lb.

Weight Capacity (Metric)

141 kg

eClass 14 Classification Group

13090401

3M™ DBI-SALA® SSB Cable Climb Assist System Lifeline Assembly 3530200, 1/4 in Stainless Steel 7 x 19, 200 ft

Part Number 3530200 3M Product Number 3530200 3M ID 7012819383

Details

No limit to length of system
Aluminum housing
Aids workers and provides fall protection while climbing lengthy ladders and towers

Typical properties

Attachment Type
None
Brands
DBI-SALA®
Case Quantity
1
Connected Safety ID Equipped
No
Install Type
Permanent
Lifeline Length (Imperial)
200 ft
Lifeline Length (Metric)
60.96 m
Lifeline Material
Stainless Steel
Maximum Number of Users
One

Dimensions and Classifications

Overall Length (Imperial)
200 ft

3M™ DBI-SALA® SSB Cable Climb Assist System Lifeline Assembly 3512180, 1/4 in Galvanized Steel 7 x 19, 180 ft

Part Number 3512180 3M Product Number 3512180 3M ID 7012819334

Details

No limit to length of system
Aluminum housing
Aids workers and provides fall protection while climbing lengthy ladders and towers

Typical properties

Attachment Type
None
Brands
DBI-SALA®
Case Quantity
1
Connected Safety ID Equipped
No
Install Type
Permanent
Lifeline Length (Imperial)
180 ft
Lifeline Length (Metric)
54.86 m
Lifeline Material
Galvanized Steel
Maximum Number of Users
One

Dimensions and Classifications

Overall Length (Imperial)
180 ft

3M™ DBI-SALA® Lad-Saf™ Mobile Rope Grab 5000335, 1 EA

Part Number 5000335 3M Product Number 5000335 3M ID 7100204313

Details

Mobile design follows user

Inertia and cam locking systems for safety

For use with 5/8" (16 mm) diameter polyester/polypropylene blend rope lifeline

Typical properties

Attachment Type

None

Brands

DBI-SALA®

Case Quantity

1

Connected Safety ID Equipped

No

Install Type

Temporary

Maximum Number of Users

One

Product Series

Lad-Saf™

Product Type

Mobile Rope Grab

Recommended Industry

Construction, General Indu

3M™ Premium 4-Point Chin Strap with Magnetic Buckle and Selector for SecureFit™ Safety Helmet X5000 Series X5-P4PTCS2, 10 EA/Case

Part Number X5-S4PTCS2 3M Product Number X5-P4PTCS2 3M ID 7100175589

Details

Use as a replacement part for the 3M™ SecureFit™ X5000 Series Safety Helmet 4-point chin strap selector system unique to 3M allows wearer to convert between EN 12492 and EN 397 standards

Includes magnetic buckle

Made to be comfortable while still providing reliable safety and stability

Designed for easy and fast adjustment

Easy and quick to use

Typical properties

Brands

3M™

Buckle Type

Magnetic Quick Release

Case Quantity

10

Compatible Hard Hat

X5000

For Use With

3M™ Safety Helmet

Material

Nylon

Product Color

Black

Product Series

X5000

Product Type

Chin Strap

Recommended Application

Demolition,

3M™ Standard 4-Point Chin Strap with Buckle and Selector for SecureFit™ Safety Helmet X5000 Series X5-S4PTCS2, 10 EA/Case

Part Number X5-S4PTCS2 3M Product Number X5-S4PTCS2 3M ID 7100175587

Details

Use as a replacement part for the 3M™ SecureFit™ X5000 Series Safety Helmet 4-point chin strap selector system unique to 3M allows wearer to convert between EN 12492 and EN 397 standards

Includes standard buckle

Made to be comfortable while still providing reliable safety and stability

Designed for easy and fast adjustment

Easy and quick to use

Typical properties

Brands

3M™

Buckle Type

Quick Release

Case Quantity

10

Compatible Hard Hat

X5000

For Use With

3M™ Safety Helmet

Material

Nylon

Product Color

Black

Product Series

X5000

Product Type

Chin Strap

Recommended Application

Demolition, Forestry,

3M™ Elastic Chin Strap X24, 46551-00000 10 EA/Case

3M Product Number 46551-00000 3M ID 7000029947 UPC 10078371465510

Details

Essential for added comfort and control on wet or windy job sites
Great help in off-the-ground situations
Dual strap-and-buckle adjusters; fits most standard hard hats
A cost-effective item to keep in stock

Typical properties

Brands
3M™
Case Quantity
10
Compatible Hard Hat
H-700, H-700T, H-800
For Use With
3M™ Headgear Systems, Hard Hats
High Heat
Yes
Material
Nylon
Product Color
Green
Product Type
Chin Strap
Recommended Industry
Automotive, Construction, Food

Dimensions and Classifications

Overall Height (Imperial)
3.88 in
Overall Height (Metric)
9.84 cm
Overall Length (Imperial)
6.5 in
Overall Length (Metric)
16.51 cm
Overall Width (Imperial)
3.5 in
Overall Width (Metric)
8.89 cm

3M™ X5-P4PTCS1 Premium 4 Point Chin Strap with magnetic buckle for SecureFit™ Safety Helmet

3M Product Number X5-P4PTCS1 3M ID 7100207541 UPC 50076308944976

Details

Magnetic buckle for one-hand operation
easy adjustment
Fits 3M™ SecureFit™ X5000 Series Safety Helmets

Typical properties

Brands
SecureFit™
Case Quantity
10
Compatible Hard Hat
X5000
For Use With
Hard Hats
Material
Nylon
Product Color
Black
Product Series
X5000
Product Type
Chin Strap, Hard Hat Accessory
Recommended Application
Demolition, Forestry, Oil & Ga

3M™ DBI-SALA® Nano-Lok™ Dual-Pin Style SRL Connector for Single-leg or Twin-leg 3100483

Part Number 3100483 3M Product Number 3100483 3M ID 7100230462

Details

High strength construction
Corrosion resistant design
Attach single leg or twin leg units directly to harness webbing below dorsal D-ring

Typical properties

Brands
DBI-SALA®
Case Quantity
1
Connected Safety ID Equipped
No
Recommended Industry
Construction, General Industrial, Oil & Gas, Transportation, Utilities
Weight (Imperial)
0.39 lb.
eClass 14 Classification Group
15310100

3M™ DBI-SALA® Nano-Lok™ Single-Pin Style SRL Connector for Single-leg or Twin-leg 3100480

Part Number 3100480 3M Product Number 3100480 3M ID 7100230460

Details

High strength construction

Corrosion resistant design

Attach single leg or twin leg units directly to harness webbing below dorsal D-ring

Typical properties

Brands

DBI-SALA®

Case Quantity

1

Connected Safety ID Equipped

No

Recommended Industry

Construction, General Industrial, Oil & Gas, Transportation, Utilities

Weight (Imperial)

0.315 lb.

eClass 14 Classification Group

15310100

3M™ DBI-SALA® Temporary I-Beam Horizontal Lifeline Stanchion Base 7400052, Fits 6 - 12 in Flange Up To 2.25 in Thick

Part Number 7400052 3M Product Number 7400052 3M ID 7012820226

Details

Conveniently adjusts from the top of the beam for ease of use and safety
Transforms your concrete horizontal lifeline configuration into an I-beam system
Portable design is durable, yet lightweight, for easy transport
Designed for use with 3M™ DBI-SALA® stanchions and lifelines (sold separately)
Recommended for multiple industries including construction, general industrial, general manufacturing, and more
This safety equipment is intended for use with additional personal protective equipment (PPE)
Intended for use as a temporary horizontal lifeline system
Horizontal fall protection allows workers exceptional mobility on the job
Equipped with RFID identification tag for convenient equipment tracking

Typical properties

Brands
DBI-SALA®
Case Quantity
1
Connected Safety ID Equipped
Yes
Install Type
Temporary/Portable
Lifeline Material
Order separately
Maximum Number of Workers
2 Per Span, 6 Total
Product Series
SecuraSpan™
Product Type
I-Beam HLL Stanchion

3M™ Secure Click™ Half Facepiece Reusable Respirator with Speaking Diaphragm HF-801SD, Small, 10 ea/Case

3M Product Number HF-801SD 3M ID 7100172045 UPC 04054596595064

Details

Speaking diaphragm is designed to help provide easier communication while you work

Push button seal check is an easy way to conduct the required seal check prior to each use

Secure Click™ connection style enables a quick, simple connection of filters and/or cartridges

Secure Click™ cartridges are dual-flow to allow easy breathing and greater comfort

Patented silicone flex-joint face seal provides a softer feel for more comfort

Easy-adjust head cradle buckles provide two-way adjustability

Low profile design offers a wide field of view and compatibility with certain welding and grinding shields

For workplace/occupational use only

Package contents: 1 case contains 10 each facepieces

Typical properties

Accessories

No

Brands

Secure Click™

Clip-on Welding Shield

No

Compatible with 3M™ PAPR Systems

No

Compatible with 3M™ Supplied Air System

No

Compatible with Welding Shield

Yes

Connection Type

Secure Click™

Cool Flow™ Exhalation Valve

No

Dr

Dimensions and Classifications

Overall Height (Metric)

134 mm

Overall Width (Metric)

125 mm

3M™ Secure Click™ Half Facepiece Reusable Respirator with Speaking Diaphragm HF-802SD, Medium, 10 ea/Case

3M Product Number HF-802SD 3M ID 7100172051 UPC 04054596595095

Details

Speaking diaphragm is designed to help provide easier communication while you work

Push button seal check is an easy way to conduct the required seal check prior to each use

Secure Click™ connection style enables a quick, simple connection of filters and/or cartridges

Secure Click™ cartridges are dual-flow to allow easy breathing and greater comfort

Patented silicone flex-joint face seal provides a softer feel for more comfort

Easy-adjust head cradle buckles provide two-way adjustability

Low profile design offers a wide field of view and compatibility with certain welding and grinding shields

For workplace/occupational use only

Package contents: 1 case contains 10 each facepieces

Typical properties

Accessories

No

Brands

Secure Click™

Clip-on Welding Shield

No

Compatible with 3M™ PAPR Systems

No

Compatible with 3M™ Supplied Air System

No

Compatible with Welding Shield

Yes

Connection Type

Secure Click™

Cool Flow™ Exhalation Valve

No

Dr

Dimensions and Classifications

Overall Height (Metric)

138 mm

Overall Width (Metric)

125 mm

3M™ Secure Click™ Half Facepiece Reusable Respirator with Speaking Diaphragm HF-803SD, Large, 10 ea/Case

3M Product Number HF-803SD 3M ID 7100172000 UPC 04054596595125

Details

Speaking diaphragm is designed to help provide easier communication while you work

Push button seal check is an easy way to conduct the required seal check prior to each use

Secure Click™ connection style enables a quick, simple connection of filters and/or cartridges

Secure Click™ cartridges are dual-flow to allow easy breathing and greater comfort

Patented silicone flex-joint face seal provides a softer feel for more comfort

Easy-adjust head cradle buckles provide two-way adjustability

Low profile design offers a wide field of view and compatibility with certain welding and grinding shields

For workplace/occupational use only

Package contents: 1 case contains 10 each facepieces

Typical properties

Accessories

No

Brands

Secure Click™

Clip-on Welding Shield

No

Compatible with 3M™ PAPR Systems

No

Compatible with 3M™ Supplied Air System

No

Compatible with Welding Shield

Yes

Connection Type

Secure Click™

Cool Flow™ Exhalation Valve

No

Dr

Dimensions and Classifications

Overall Height (Metric)

142 mm

Overall Width (Metric)

125 mm

3M™ DBI-SALA® Fixed Ladder Self-Retracting Lifeline Anchor Tagline 6100566, Stainless Steel

Part Number 6100566 3M Product Number 6100566 3M ID 7100260187

Details

Easy to transport. Under 30 lbs. (13.6 kg) for ease of transport and installation
Simple to setup up installs on the ladder in 5 minutes or less. Versatile installation allows the ladder anchor to be mounted to front or behind the ladder with left, right or center alignments
Compatible with your existing fall protection harness. Unlike a fixed cable system, this solution doesn't require a front D-Ring, which can reduce overall implementation costs
Designed for durability. Built to withstand permanent or temporary applications
Compliance comes standard. Meets 29 CFR OSHA 1910 Walking Working Surfaces Section 1910.27

Typical properties

Brands
DBI-SALA®
Carabiner/Hook Material
Metal
Case Quantity
1 each
Connected Safety ID Equipped
No
For Use With
3M™ DBI-SALA® Smart Lock 3503800, 30 ft., 3M™ DBI-SALA®Smart Lock 3503824, 50 ft. 1 Each
Net Weight (Metric)
1.588 kg
Product Colo

3M™ Pen Holder Quick Spin Tool Attachment Point 1500031, 1 lb Capacity, 0.3 in, 10 ea/Pack

3M Product Number 1500031 3M ID 7100241872 UPC 00852684932647

Details

Compatible with 3M™ DBI-SALA® Fall Protection for Tools accessories
Provides workers an attachment point to secure tools and accessories while working at height
Multiple attachment point and capacity options designed for a variety of applications

Typical properties

Brands
DBI-SALA®
Case Quantity
10
Connected Safety ID Equipped
No
Manufacturing Origin
Taiwan
Net Weight (Metric)
0.06 kg
Product Color
Yellow
Product Type
Quick Spin (Pen Holder)
Recommended Industry
Construction, General Industrial, Minin

Dimensions and Classifications

Overall Height (Metric)
12.7 mm
Overall Length (Metric)
279.4 mm

**3M™ Pen Holder Quick Spin with Coil Tool Attachment Point 1500032,
1 lb
Capacity, 0.3 in, 10 ea/Pack**

3M Product Number 1500032 3M ID 7100310223 UPC 00852684932678

Details

Compatible with 3M™ DBI-SALA® Fall Protection for Tools accessories
Provides workers an attachment point to secure tools and accessories while
working at height
Multiple attachment point and capacity options designed for a variety of
applications

Typical properties

Brands
DBI-SALA®
Case Quantity
10
Connected Safety ID Equipped
No
Manufacturing Origin
Taiwan
Net Weight (Metric)
0.2 kg
Product Color
Yellow
Product Type
Quick Spin (Pen Holder with Coil)
Recommended Industry
Construction, General Industri

Dimensions and Classifications

Overall Height (Metric)
31.75 mm
Overall Length (Metric)
285.75 mm

3M™ Hook2Quick-Ring Coil Tool Tether 1500066, 2 lb Capacity, 3 - 62 in, 10 ea/Pack

3M Product Number 1500066 3M ID 7100312707 UPC 00852684931008

Details

Compatible with 3M™ DBI-SALA® Fall Protection for Tools accessories
Provides workers an attachment point to secure tools and accessories while working at height
Multiple attachment point and capacity options designed for a variety of applications

Typical properties

Brands
DBI-SALA®
Case Quantity
1
Connected Safety ID Equipped
No
Dimensions
157.5 cm
Manufacturing Origin
Taiwan
Net Weight (Imperial)
2.25 lb
Net Weight (Metric)
1.02 kg
Product Color
Black, Yellow
Product Type
Hook2Quick Ring Coil Tool

Dimensions and Classifications

Overall Height (Metric)
68.58 mm
Overall Length (Metric)
307.34 mm

**3M™ Permanent Marker Quick Spin with Coil Tool Attachment Point
1500034,
1 lb Capacity, 0.5 in, 10 ea/Pack**

3M Product Number 1500034 3M ID 7100310224 UPC 00852684932746

Details

Compatible with 3M™ DBI-SALA® Fall Protection for Tools accessories
Provides workers an attachment point to secure tools and accessories while working at height
Multiple attachment point and capacity options designed for a variety of applications

Typical properties

Brands
DBI-SALA®
Case Quantity
10
Connected Safety ID Equipped
No
Manufacturing Origin
Taiwan
Net Weight (Metric)
0.17 kg
Product Color
Yellow
Product Type
Quick Spin (Permanent Marker Holder with Coil)
Recommended Industry
Construction, Ge

Dimensions and Classifications

Overall Height (Metric)
20.49 mm
Overall Length (Metric)
292.1 mm

3M™ DBI-SALA® Dual D-ring Attachment 1500001, Small, 10 EA/PACK

3M Product Number 1500001 3M ID 7100214248 UPC 00852684930599

Details

Compatible with 3M™ DBI-SALA® Fall Protection for Tools accessories
Provides workers an attachment point to secure tools and accessories while working at height
Multiple attachment point and capacity options designed for a variety of applications

Typical properties

Brands
DBI-SALA®
Case Quantity
10
Connected Safety ID Equipped
No
Dimensions
0.50 x 2.25 inch
Manufacturing Origin
Taiwan
Net Weight (Metric)
0.22 kg
Product Type
Dual D-ring Attachment
Recommended Industry
Construction, General Industrial,

Dimensions and Classifications

Overall Height (Metric)
19.05 mm
Overall Length (Metric)
292.1 mm

3M™ DBI-SALA® Quick Wrap Tape II 1500169, Blue 1"x108", 10/PAC

3M Product Number 1500169 3M ID 7100204961 UPC 00840779151318

Details

Compatible with 3M™ DBI-SALA® Fall Protection for Tools accessories
Provides workers an attachment point to secure tools and accessories while working at height
Multiple attachment point and capacity options designed for a variety of applications

Typical properties

Brands
DBI-SALA®
Case Quantity
10
Connected Safety ID Equipped
No
Dimensions
2.25 x 2.25 x 1.00 inch
Net Weight (Imperial)
1.45 lb
Net Weight (Metric)
0.65 kg
Product Color
Blue
Product Type
Quick Wrap Tape
Recommended Industry
Constructi

Dimensions and Classifications

Overall Length (Imperial)
9 ft
Overall Length (Metric)
2.74 m

3M™ Heat Shrink Tool Attachment Point 1500019, 0.75 in x 1.75 in, 25 ea/Pack

3M Product Number 1500019 3M ID 7100241915 UPC 00852684932005

Details

Compatible with 3M™ DBI-SALA® Fall Protection for Tools accessories
Provides workers an attachment point to secure tools and accessories while working at height
Multiple attachment point and capacity options designed for a variety of applications

Typical properties

Brands
DBI-SALA®
Case Quantity
25
Connected Safety ID Equipped
No
Dimensions
0.75 x 1.75 inch
Manufacturing Origin
Taiwan
Net Weight (Metric)
0.07 kg
Product Color
Yellow
Product Type
Heat Shrink
Recommended Industry
Construction, General

Dimensions and Classifications

Overall Height (Metric)
29.21 mm
Overall Length (Metric)
292.1 mm

3M™ DBI-SALA® Heat Shrink 1" x 1.75" 1500020, 25 ea/Pack

3M Product Number 1500020 3M ID 7100220231 UPC 00852684932074

Details

Compatible with 3M™ DBI-SALA® Fall Protection for Tools accessories
Provides workers an attachment point to secure tools and accessories while working at height
Multiple attachment point and capacity options designed for a variety of applications

Typical properties

Brands

DBI-SALA®

Case Quantity

25

Connected Safety ID Equipped

No

Dimensions

1.00 x 1.75 inch

Product Color

Yellow

Product Type

Heat Shrink

Recommended Industry

Construction, General Industrial, Mining, Oil & Gas, Transportation

Weight Capac

3M™ DBI-SALA® D-ring Attachment 0.5" x 2.25" Non-Conductive 1500005, 10 EA/PACK

3M Product Number 1500005 3M ID 7100214252 UPC 00852684930674

Details

Compatible with 3M™ DBI-SALA® Fall Protection for Tools accessories
Provides workers an attachment point to secure tools and accessories while working at height
Multiple attachment point and capacity options designed for a variety of applications

Typical properties

Brands
DBI-SALA®
Case Quantity
10
Connected Safety ID Equipped
No
Dimensions
0.50 x 2.25 inch
Manufacturing Origin
Taiwan
Net Weight (Imperial)
0.3 lb
Net Weight (Metric)
0.1 kg
Product Type
D-ring Attachment 0.5 in x 2.25 in (Non-conductiv

Dimensions and Classifications

Overall Height (Metric)
15.32 mm
Overall Length (Metric)
292.1 mm

3M™ Heat Shrink Tool Attachment Point 1500022, 2 in x 4 in, 10 ea/Pack

3M Product Number 1500022 3M ID 7100239363 UPC 00852684932098

Details

Compatible with 3M™ DBI-SALA® Fall Protection for Tools accessories
Provides workers an attachment point to secure tools and accessories while working at height
Multiple attachment point and capacity options designed for a variety of applications

Typical properties

Brands
DBI-SALA®
Case Quantity
10
Connected Safety ID Equipped
No
Dimensions
2.00 x 4.00 inch
Manufacturing Origin
Taiwan
Net Weight (Metric)
0.11 kg
Product Color
Yellow
Product Type
Heat Shrink
Recommended Industry
Construction, General

Dimensions and Classifications

Overall Height (Metric)
28.58 mm
Overall Length (Metric)
298.45 mm

3M™ DBI-SALA® D-ring Attachment 0.5" x 2.25" Non-Conductive 1500006, 100 EA/PACK

3M Product Number 1500006 3M ID 7100214253 UPC 00852684930650

Details

Compatible with 3M™ DBI-SALA® Fall Protection for Tools accessories
Provides workers an attachment point to secure tools and accessories while working at height
Multiple attachment point and capacity options designed for a variety of applications

Typical properties

Brands
DBI-SALA®
Case Quantity
100
Connected Safety ID Equipped
No
Dimensions
0.50 x 2.25 inch
Net Weight (Imperial)
0.3 lb
Net Weight (Metric)
0.1 kg
Product Type
D-ring Attachment 0.5 in x 2.25 in (Non-conductive)
Recommended Industry
Con

3M™ DBI-SALA® Quick Ring 1.50" 1500026, 25 ea/Pack

3M Product Number 1500026 3M ID 7100223420 UPC 00852684932586

Details

Compatible with 3M™ DBI-SALA® Fall Protection for Tools accessories
Provides workers an attachment point to secure tools and accessories while working at height
Multiple attachment point and capacity options designed for a variety of applications

Typical properties

Brands
DBI-SALA®
Case Quantity
25
Connected Safety ID Equipped
No
Dimensions
1.50 x 0.18 inch
Manufacturing Origin
USA
Net Weight (Metric)
0.27 kg
Product Type
Quick Ring
Recommended Industry
Construction, General Industrial, Mining, Oil &

Dimensions and Classifications

Overall Height (Metric)
5.16 mm
Overall Length (Metric)
193.68 mm

3M™ DBI-SALA® D-Ring Attachment 1" x 3.5" 1500007, 10 EA/Pack

3M Product Number 1500007 3M ID 7100210210 UPC 00852684930698

Details

Compatible with 3M™ DBI-SALA® Fall Protection for Tools accessories
Provides workers an attachment point to secure tools and accessories while working at height
Multiple attachment point and capacity options designed for a variety of applications

Typical properties

Brands
DBI-SALA®
Case Quantity
10
Connected Safety ID Equipped
No
Dimensions
1.00 x 3.50 inch
Manufacturing Origin
Taiwan
Net Weight (Metric)
0.26 kg
Product Type
D-ring Attachment 1 in x 3.5 in
Recommended Industry
Construction, General In

Dimensions and Classifications

Overall Height (Imperial)
1.3 in
Overall Height (Metric)
33.02 mm
Overall Length (Imperial)
11.75 in
Overall Length (Metric)
298.45 mm

3M™ DBI-SALA® Quick Spin Medium Size 1500028, 10 EA/Pack

3M Product Number 1500028 3M ID 7100210211 UPC 00852684932623

Details

Compatible with 3M™ DBI-SALA® Fall Protection for Tools accessories
Provides workers an attachment point to secure tools and accessories while working at height
Multiple attachment point and capacity options designed for a variety of applications

Typical properties

Brands
DBI-SALA®
Case Quantity
10
Connected Safety ID Equipped
No
Manufacturing Origin
Taiwan
Net Weight (Metric)
0.12 kg
Product Type
Quick Spin
Recommended Industry
Construction, General Industrial, Mining, Oil & Gas, Transportation
Weight

Dimensions and Classifications

Overall Height (Metric)
18.36 mm
Overall Length (Metric)
288.93 mm

3M™ DBI-SALA® Quick Spin X-Large Size 1500030, 10 EA/Pack

3M Product Number 1500030 3M ID 7100210233 UPC 00852684932791

Details

Compatible with 3M™ DBI-SALA® Fall Protection for Tools accessories
Provides workers an attachment point to secure tools and accessories while working at height
Multiple attachment point and capacity options designed for a variety of applications

Typical properties

Brands
DBI-SALA®
Case Quantity
10
Connected Safety ID Equipped
No
Manufacturing Origin
Taiwan
Net Weight (Metric)
0.18 kg
Product Type
Quick Spin
Recommended Industry
Construction, General Industrial, Mining, Oil & Gas, Transportation
Weight

Dimensions and Classifications

Overall Height (Metric)
39.37 mm
Overall Length (Metric)
285.75 mm

3M™ DBI-SALA® Quick Wrap Tape II 1500175, Yellow, 1"x 108", 10 E/PACK

3M Product Number 1500175 3M ID 7100217304 UPC 00840779151370

Details

Compatible with 3M™ DBI-SALA® Fall Protection for Tools accessories
Provides workers an attachment point to secure tools and accessories while working at height
Multiple attachment point and capacity options designed for a variety of applications

Typical properties

Brands
DBI-SALA®
Case Quantity
10
Connected Safety ID Equipped
No
Dimensions
2.25 x 2.25 x 1.00 inch
Net Weight (Imperial)
1.5 lb
Net Weight (Metric)
0.68 kg
Product Color
Yellow
Product Type
Quick Wrap Tape
Recommended Industry
Construct

Dimensions and Classifications

Overall Length (Imperial)
9 ft
Overall Length (Metric)
2.74 m

3M™ Permanent Marker Quick Spin Tool Attachment Point 1500033, 1 lb Capacity, 0.5 in, 10 ea/Pack

3M Product Number 1500033 3M ID 7100242311 UPC 00852684932708

Details

Compatible with 3M™ DBI-SALA® Fall Protection for Tools accessories
Provides workers an attachment point to secure tools and accessories while working at height
Multiple attachment point and capacity options designed for a variety of applications

Typical properties

Brands
DBI-SALA®
Case Quantity
10
Connected Safety ID Equipped
No
Manufacturing Origin
Taiwan
Net Weight (Metric)
0.24 kg
Product Color
Yellow
Product Type
Quick Spin (Permanent Marker Holder)
Recommended Industry
Construction, General Indu

Dimensions and Classifications

Overall Height (Metric)
31.75 mm
Overall Length (Metric)
285.75 mm

3M™ DBI-SALA® Quick Wrap Tape II 1500176, Yellow, 1"x 108", 120 ea/Pack

3M Product Number 1500176 3M ID 7100217324 UPC 00840779151387

Details

Compatible with 3M™ DBI-SALA® Fall Protection for Tools accessories
Provides workers an attachment point to secure tools and accessories while working at height
Multiple attachment point and capacity options designed for a variety of applications

Typical properties

Brands
DBI-SALA®
Case Quantity
120
Connected Safety ID Equipped
No
Dimensions
2.25 x 2.25 x 1.00 inch
Net Weight (Imperial)
19.5 lb
Net Weight (Metric)
8.84 kg
Product Color
Yellow
Product Type
Quick Wrap Tape
Recommended Industry
Constru

Dimensions and Classifications

Overall Length (Imperial)
9 ft
Overall Length (Metric)
2.74 m

3M™ DBI-SALA® Quick Wrap Tape II 1500172, Blue 1"x216", 10 E/PACK

3M Product Number 1500172 3M ID 7100214239 UPC 00840779151349

Details

Compatible with 3M™ DBI-SALA® Fall Protection for Tools accessories
Provides workers an attachment point to secure tools and accessories while working at height
Multiple attachment point and capacity options designed for a variety of applications

Typical properties

Brands
DBI-SALA®
Case Quantity
10
Connected Safety ID Equipped
No
Dimensions
2.87 x 2.87 x 1.00 inch
Net Weight (Imperial)
2.45 lb
Net Weight (Metric)
1.11 kg
Product Color
Blue
Product Type
Quick Wrap Tape
Recommended Industry
Constructi

Dimensions and Classifications

Overall Length (Imperial)
18 ft
Overall Length (Metric)
5.48 m

3M™ Heat Shrink Tool Attachment Point 1500021, 1.5 in x 2 in, 25 ea/Pack

3M Product Number 1500021 3M ID 7012818079 UPC 00852684932029

Details

Compatible with 3M™ DBI-SALA® Fall Protection for Tools accessories
Provides workers an attachment point to secure tools and accessories while working at height
Multiple attachment point and capacity options designed for a variety of applications

Typical properties

Brands

DBI-SALA®

Case Quantity

25

Connected Safety ID Equipped

No

Dimensions

1.50 x 2.00 inch

Product Color

Yellow

Product Type

Heat Shrink

Recommended Industry

Construction, General Industrial, Mining, Oil & Gas, Transportation

eClass 14 CI

3M™ DBI-SALA® Quick Wrap Tape II 1500173, Blue 1"x216", 60/PAC

3M Product Number 1500173 3M ID 7100204963

Details

Compatible with 3M™ DBI-SALA® Fall Protection for Tools accessories
Provides workers an attachment point to secure tools and accessories while working at height
Multiple attachment point and capacity options designed for a variety of applications

Typical properties

Brands

DBI-SALA®

Case Quantity

60

Connected Safety ID Equipped

No

Dimensions

2.87 x 2.87 x 1.00 inch

Net Weight (Imperial)

14.76 lb

Product Type

Quick Wrap Tape

Recommended Industry

Construction, General Industrial, Mining, Oil & Gas, Transpo

Dimensions and Classifications

Overall Length (Imperial)

18 ft

3M™ Heat Shrink Tool Attachment Point 1500023, 3 in x 4 in, 10 ea/Pack

3M Product Number 1500023 3M ID 7100316896 UPC 00852684932128

Details

Compatible with 3M™ DBI-SALA® Fall Protection for Tools accessories
Provides workers an attachment point to secure tools and accessories while working at height
Multiple attachment point and capacity options designed for a variety of applications

Typical properties

Brands

DBI-SALA®

Case Quantity

10

Connected Safety ID Equipped

No

Dimensions

3.00 x 4.00 inch

Product Color

Yellow

Product Type

Heat Shrink

Recommended Industry

Construction, General Industrial, Mining, Oil & Gas, Transportation

Weight Capac

3M™ DBI-SALA® Quick Wrap Tape II 1500170, Blue 1"x108", 120/PAC

3M Product Number 1500170 3M ID 7100204962 UPC 00840779151325

Details

Compatible with 3M™ DBI-SALA® Fall Protection for Tools accessories
Provides workers an attachment point to secure tools and accessories while working at height
Multiple attachment point and capacity options designed for a variety of applications

Typical properties

Brands
DBI-SALA®
Case Quantity
120
Connected Safety ID Equipped
No
Dimensions
2.25 x 2.25 x 1.00 inch
Net Weight (Imperial)
17.4 lb
Net Weight (Metric)
7.89 kg
Product Color
Blue
Product Type
Quick Wrap Tape
Recommended Industry
Construct

Dimensions and Classifications

Overall Length (Imperial)
9 ft
Overall Length (Metric)
2.74 m

3M™ Cinch Tool Attachment Point 1500012, 35 lb Capacity, 10 ea/Pack

3M Product Number 1500012 3M ID 7100275355 UPC 00852684933026

Details

Compatible with 3M™ DBI-SALA® Fall Protection for Tools accessories
Provides workers an attachment point to secure tools and accessories while working at height
Multiple attachment point and capacity options designed for a variety of applications

Typical properties

Brands
DBI-SALA®
Case Quantity
10
Connected Safety ID Equipped
No
Manufacturing Origin
Taiwan
Net Weight (Metric)
0.52 kg
Product Color
Yellow
Product Type
Tool Cinch Medium Duty
Recommended Industry
Construction, General Industrial, Mining

Dimensions and Classifications

Overall Height (Metric)
50.8 mm
Overall Length (Metric)
281.94 mm

3M™ Single Wing Cinch Tool Attachment Point 1500014, 35 lb Capacity, 10 ea/Pack

3M Product Number 1500014 3M ID 7100310175 UPC 00852684932944

Details

Compatible with 3M™ DBI-SALA® Fall Protection for Tools accessories
Provides workers an attachment point to secure tools and accessories while working at height
Multiple attachment point and capacity options designed for a variety of applications

Typical properties

Brands
DBI-SALA®
Case Quantity
10
Connected Safety ID Equipped
No
Manufacturing Origin
Taiwan
Net Weight (Metric)
0.22 kg
Product Type
Tool Cinch - Single Wing Medium Duty
Recommended Industry
Construction, General Industrial, Mining, Oil & G

Dimensions and Classifications

Overall Height (Metric)
41.28 mm
Overall Length (Metric)
298.45 mm

3M™ Dual Wing Cinch Tool Attachment Point 1500016, 35 lb Capacity, 10 ea/Pack

3M Product Number 1500016 3M ID 7012689168 UPC 00852684932982

Details

Compatible with 3M™ DBI-SALA® Fall Protection for Tools accessories
Provides workers an attachment point to secure tools and accessories while working at height
Multiple attachment point and capacity options designed for a variety of applications

Typical properties

Brands
DBI-SALA®
Case Quantity
10
Connected Safety ID Equipped
No
Manufacturing Origin
Taiwan
Net Weight (Metric)
0.57 kg
Product Type
Tool Cinch - Dual Wing Medium Duty
Recommended Industry
Construction, General Industrial, Mining, Oil & Gas

Dimensions and Classifications

Overall Height (Metric)
33.35 mm
Overall Length (Metric)
292.1 mm

3M™ Dual Wing Cinch Tool Attachment Point 1500018, 80 lb Capacity, 10 ea/Pack

3M Product Number 1500018 3M ID 7100310176 UPC 00852684934603

Details

Compatible with 3M™ DBI-SALA® Fall Protection for Tools accessories
Provides workers an attachment point to secure tools and accessories while working at height
Multiple attachment point and capacity options designed for a variety of applications

Typical properties

Brands
DBI-SALA®
Case Quantity
10
Connected Safety ID Equipped
No
Manufacturing Origin
Taiwan
Net Weight (Metric)
0.79 kg
Product Type
Tool Cinch - Dual Wing - Heavy Duty
Recommended Industry
Construction, General Industrial, Mining, Oil & Ga

Dimensions and Classifications

Overall Height (Metric)
77.47 mm
Overall Length (Metric)
295.91 mm

**3M™ Small Quick Ring Tool Attachment Point 1500024, 2 lb Capacity,
0.75
in, 25 ea/Pack**

3M Product Number 1500024 3M ID 7100311174 UPC 00852684932562

Details

Compatible with 3M™ DBI-SALA® Fall Protection for Tools accessories
Provides workers an attachment point to secure tools and accessories while
working at height
Multiple attachment point and capacity options designed for a variety of
applications

Typical properties

Brands
DBI-SALA®
Case Quantity
25
Connected Safety ID Equipped
No
Dimensions
0.75 x 0.14 inch
Manufacturing Origin
USA
Net Weight (Metric)
0.08 kg
Product Type
Quick Ring
Recommended Industry
Construction, General Industrial, Mining, Oil &

Dimensions and Classifications

Overall Height (Metric)
11.43 mm
Overall Length (Metric)
203.2 mm

3M™ Small Quick Spin Tool Attachment Point 1500027, 1 lb Capacity, 0.6 in, 10 ea/Pack

3M Product Number 1500027 3M ID 7100239364 UPC 00852684932777

Details

Compatible with 3M™ DBI-SALA® Fall Protection for Tools accessories
Provides workers an attachment point to secure tools and accessories while working at height
Multiple attachment point and capacity options designed for a variety of applications

Typical properties

Brands
DBI-SALA®
Case Quantity
10
Connected Safety ID Equipped
No
Manufacturing Origin
Taiwan
Net Weight (Metric)
0.14 kg
Product Type
Quick Spin
Recommended Industry
Construction, General Industrial, Mining, Oil & Gas, Transportation
Weight

Dimensions and Classifications

Overall Height (Metric)
25.4 mm
Overall Length (Metric)
284.48 mm

3M™ DBI-SALA® Quick Wrap Tape II 1500174, Yellow 1"x108"

3M Product Number 1500174 3M ID 7100204330 UPC 00840779151363

Details

Compatible with 3M™ DBI-SALA® Fall Protection for Tools accessories
Provides workers an attachment point to secure tools and accessories while working at height
Multiple attachment point and capacity options designed for a variety of applications

Typical properties

Brands

DBI-SALA®

Case Quantity

1

Connected Safety ID Equipped

No

Dimensions

2.25 x 2.25 x 1.00 inch

Net Weight (Imperial)

0.11 lb

Product Type

Quick Wrap Tape

Recommended Industry

Construction, General Industrial, Mining, Oil & Gas, Transport

Dimensions and Classifications

Overall Length (Imperial)

9 ft

3M™ DBI-SALA® Quick Spin Large Size 1500029, 10 EA/Pack

3M Product Number 1500029 3M ID 7100210212 UPC 00852684932609

Details

Compatible with 3M™ DBI-SALA® Fall Protection for Tools accessories
Provides workers an attachment point to secure tools and accessories while working at height
Multiple attachment point and capacity options designed for a variety of applications

Typical properties

Brands
DBI-SALA®
Case Quantity
10
Connected Safety ID Equipped
No
Manufacturing Origin
Taiwan
Net Weight (Metric)
0.15 kg
Product Type
Quick Spin
Recommended Industry
Construction, General Industrial, Mining, Oil & Gas, Transportation
Weight

Dimensions and Classifications

Overall Height (Metric)
58.42 mm
Overall Length (Metric)
303.53 mm

3M™ DBI-SALA® Quick Wrap Tape II 1500168, Blue 1"x108"

3M Product Number 1500168 3M ID 7100204329 UPC 00840779151301

Details

Compatible with 3M™ DBI-SALA® Fall Protection for Tools accessories
Provides workers an attachment point to secure tools and accessories while working at height
Multiple attachment point and capacity options designed for a variety of applications

Typical properties

Brands

DBI-SALA®

Case Quantity

1

Connected Safety ID Equipped

No

Dimensions

2.25 x 2.25 x 1.00 inch

Net Weight (Imperial)

0.11 lb

Product Type

Quick Wrap Tape

Recommended Industry

Construction, General Industrial, Mining, Oil & Gas, Transport

Dimensions and Classifications

Overall Length (Imperial)

9 ft

3M™ DBI-SALA® D-ring Attachment 1" x 3.5" 1500008, 50 EA/PACK

3M Product Number 1500008 3M ID 7100214254 UPC 00852684930711

Details

Compatible with 3M™ DBI-SALA® Fall Protection for Tools accessories
Provides workers an attachment point to secure tools and accessories while working at height
Multiple attachment point and capacity options designed for a variety of applications

Typical properties

Brands
DBI-SALA®
Case Quantity
50
Connected Safety ID Equipped
No
Dimensions
1.00 x 3.50 inch
Net Weight (Imperial)
0.3 lb
Net Weight (Metric)
0.1 kg
Product Type
D-ring Attachment 1 in x 3.5 in
Recommended Industry
Construction, General In

3M™ Micro D-ring Cord Tool Attachment Point 1500010, 2 lb Capacity, 10 ea/Pack

3M Product Number 1500010 3M ID 7012599294 UPC 00852684933422

Details

Compatible with 3M™ DBI-SALA® Fall Protection for Tools accessories
Provides workers an attachment point to secure tools and accessories while working at height
Multiple attachment point and capacity options designed for a variety of applications

Typical properties

Brands
DBI-SALA®
Case Quantity
10
Connected Safety ID Equipped
No
Manufacturing Origin
USA
Net Weight (Metric)
0.01 kg
Product Color
Black
Product Type
Micro D-ring
Recommended Industry
Construction, General Industrial, Mining, Oil & Gas, T

Dimensions and Classifications

Overall Height (Metric)
11.43 mm
Overall Length (Metric)
99.06 mm

3M™ Particulate Filter 7093, P100 60 EA/Case

3M Product Number 7093 3M ID 7000002154 UPC 50051131527053

Typical properties

Accessories

Yes

Aerosol Type

Oil and Non-Oil

Brands

3M™

Cartridge or Filter Type

Particulate

Case Quantity

60/case

Clip-on Welding Shield

Yes

Compatible Respirator

3M™ Full Facepieces 6000, 3M™ Full Facepieces 7800 Series, 3M™ Full Facepieces

Dimensions and Classifications

Overall Height (Imperial)

2.3 in

Overall Length (Imperial)

3.4 in

3M™ Particulate Filter 7093B, P100 144 EA/Case

Part Number 52706 3M Product Number 7093B 3M ID 7000002155

Typical properties

Accessories

No

Aerosol Type

Oil and Non-Oil

Brands

3M™

Cartridge or Filter Type

Particulate

Case Quantity

1/pack

Clip-on Welding Shield

No

Compatible Respirator

3M™ Full Facepieces 6000, 3M™ Full Facepieces 7800 Series, 3M™ Full Facepieces FF

Dimensions and Classifications

Overall Height (Imperial)

2.3 in

Overall Length (Imperial)

3.4 in

3M™ Particulate Filter 2097/07184(AAD), P100, with Nuisance Level Organic Vapor Relief 100 EA/Case

Part Number 07184 3M Product Number 2097 3M ID 7000029657

Typical properties

Accessories

Yes

Aerosol Type

Oil and Non-Oil

Brands

3M™

Cartridge or Filter Type

Particulate

Case Quantity

2/pack

Clip-on Welding Shield

Yes

Compatible Respirator

3M™ Full Facepieces 6000, 3M™ Full Facepieces 7800 Series, 3M™ Full Facepieces

Dimensions and Classifications

Overall Height (Imperial)

4.3 in

Overall Length (Imperial)

4.3 in

3M™ Hydrogen Fluoride Cartridge/Filter 7093C, P100, with Nuisance Level Organic Vapor and Acid Gas Relief, 60 EA/Case

Part Number 37173 3M Product Number 7093C 3M ID 7000052600

Typical properties

Accessories

Yes

Aerosol Type

Oil and Non-Oil

Brands

3M™

Cartridge or Filter Type

Combination

Case Quantity

60/case

Clip-on Welding Shield

Yes

Compatible Respirator

3M™ Full Facepieces 6000, 3M™ Full Facepieces 7800 Series, 3M™ Full Facepieces

Dimensions and Classifications

Overall Height (Imperial)

2.3 in

Overall Length (Imperial)

3.4 in

3M™ Particulate Cartridge 2076HF, Hydrogen Fluoride, P95, with Nuisance Level Acid Gas Relief 100 EA/Case

3M Product Number 2076HF 3M ID 7000021310 UPC 50051138543698

Typical properties

Accessories

No

Aerosol Type

Oil and Non-Oil

Brands

3M™

Cartridge or Filter Type

Particulate

Case Quantity

100/case

Clip-on Welding Shield

No

Compatible Respirator

3M™ Full Facepieces 6000, 3M™ Full Facepieces FF-400, 3M™ Half Facepiece Respir

Dimensions and Classifications

Overall Height (Imperial)

4.3 in

Overall Length (Imperial)

4.3 in

3M™ Hydrogen Fluoride Cartridge/Filter 7093CB, P100, with Nuisance Level Organic Vapor and Acid Gas Relief 144 EA/Case

3M Product Number 7093CB 3M ID 7000126938 UPC 50051131919704

Typical properties

Accessories

Yes

Aerosol Type

Oil and Non-Oil

Brands

3M™

Cartridge or Filter Type

Combination

Case Quantity

72/case

Clip-on Welding Shield

No

Compatible Respirator

3M™ Full Facepieces 6000, 3M™ Full Facepieces 7800 Series, 3M™ Full Facepieces

Dimensions and Classifications

Overall Height (Imperial)

2.3 in

Overall Length (Imperial)

3.4 in

3M™ Particulate Filter 2071, P95 100 EA/Case

Part Number 54356 3M Product Number 2071 3M ID 7000002058

Typical properties

Accessories

Yes

Aerosol Type

Oil and Non-Oil

Brands

3M™

Cartridge or Filter Type

Particulate

Case Quantity

100/case

Clip-on Welding Shield

Yes

Compatible Respirator

3M™ Full Facepieces 6000, 3M™ Full Facepieces 7800 Series, 3M™ Full Facepiece

Dimensions and Classifications

Overall Height (Imperial)

4.3 in

Overall Length (Imperial)

4.3 in

3M™ Particulate Filter 2096, P100, with Nuisance Level Acid Gas Relief 100 EA/Case

3M Product Number 2096 3M ID 7000002048 UPC 50051138542950

Typical properties

Accessories

Yes

Aerosol Type

Oil and Non-Oil

Brands

3M™

Cartridge or Filter Type

Particulate

Case Quantity

2/pack

Clip-on Welding Shield

Yes

Compatible Respirator

3M™ Full Facepieces 6000, 3M™ Full Facepieces 7800 Series, 3M™ Full Facepieces

Dimensions and Classifications

Overall Height (Imperial)

4.3 in

Overall Length (Imperial)

4.3 in

3M™ Particulate Filter 2078, P95, with Nuisance Level Organic Vapor/Acid Gas Relief 100 EA/Case

3M Product Number 2078 3M ID 7000052066 UPC 50051138543681

Details

Nuisance level organic vapor/acid gas relief

Typical properties

Accessories

Yes

Aerosol Type

Oil and Non-Oil

Brands

3M™

Cartridge or Filter Type

Particulate

Case Quantity

100/case

Clip-on Welding Shield

Yes

Compatible Respirator

3M™ Full Facepieces 6000, 3M™ Full Facepieces 7800 Series, 3M™ Full Facepiece

Dimensions and Classifications

Overall Height (Imperial)

4.3 in

Overall Length (Imperial)

4.3 in

3M™ Particulate Filter 2091/07000(AAD), P100 100 EA/Case

Part Number 07000 3M Product Number 2091 3M ID 7000051991

Typical properties

Accessories

Yes

Aerosol Type

Oil and Non-Oil

Brands

3M™

Cartridge or Filter Type

Particulate

Case Quantity

100/case

Clip-on Welding Shield

Yes

Compatible Respirator

3M™ Full Facepieces 6000, 3M™ Full Facepieces 7800 Series, 3M™ Full Facepiece

Dimensions and Classifications

Overall Height (Imperial)

4.3 in

Overall Length (Imperial)

4.3 in

3M™ Advanced Particulate Filter 2291, P100 100 EA/Case

3M Product Number 2291 3M ID 7000127449 UPC 50051131171706

Typical properties

Accessories

Yes

Aerosol Type

Oil and Non-Oil

Brands

3M™

Cartridge or Filter Type

Particulate

Case Quantity

100/case

Clip-on Welding Shield

Yes

Compatible Respirator

3M™ Full Facepieces 6000, 3M™ Full Facepieces 7800 Series, 3M™ Full Facepiece

Dimensions and Classifications

Overall Height (Imperial)

4.3 in

Overall Length (Imperial)

4.3 in

3M™ Advanced Particulate Filter 2297, P100, with Nuisance Level Organic Vapor Relief, 100 EA/Case

3M Product Number 2297 3M ID 7000127451 UPC 50051131171720

Typical properties

Accessories

Yes

Aerosol Type

Oil and Non-Oil

Brands

3M™

Cartridge or Filter Type

Particulate

Case Quantity

100/case

Clip-on Welding Shield

Yes

Compatible Respirator

3M™ Full Facepieces 6000, 3M™ Full Facepieces 7800 Series, 3M™ Full Facepiece

Dimensions and Classifications

Overall Height (Imperial)

4.3 in

Overall Length (Imperial)

4.3 in

3M™ Head Harness 6897/37005(AAD), 5 EA/Case

Part Number 37005 3M Product Number 6897 3M ID 7000002035

Details

Approved 3M replacement part
Designed for 3M Full Facepieces 6000 Series (sold separately)
Replacement part can extend respiratory equipment service life
Replaceable part can potentially result in respiratory equipment cost savings
Head harness holds facepiece against face

Typical properties

Accessories
No
Boxes per Case
5
Brands
3M™
Case Quantity
5/case
Clip-on Welding Shield
No
Compatible Respirator
6000 Series
Compatible with 3M™ PAPR Systems
No
Compatible with 3M™ Supplied Air System
No
Compatible with Welding Shield
No

3M™ Head Harness FF-800-05, 5 ea/Case

3M Product Number FF-800-05 3M ID 7100283489 UPC 00638060433645

Details

6 strap configuration

Replaceable part can potentially result in respiratory equipment cost savings

Compatible with the 3M Comfort Cradle Head Harness Attachment FF-400-06
(not included)

Typical properties

Accessories

Yes

Brands

Secure Click™

Case Quantity

5

Compatible Respirator

FF-800 Series, Secure Click™ HF-800 Series Full Facepiece Reusable
Respirators

Compatible with 3M™ PAPR Systems

No

Compatible with 3M™ Supplied Air System

No

Enhanced C

3M™ Rugged Comfort 6582 / 55887 Quick Latch Head Harness Assembly, System Component

3M Product Number 6582 3M ID 7000128252 UPC 50051141558870

Details

Easy on and off as you move in and out of contaminated areas
No need to remove your hard hat or face shield when lowering or raising your respirator
Replacement part for the 3M™ 6500QL Series (with Quick Latch)
20 each per case

Typical properties

Accessories
No
Boxes per Case
20
Brands
3M™
Case Quantity
20/case
Clip-on Welding Shield
No
Compatible Respirator
6000 Series
Compatible with 3M™ PAPR Systems
No
Compatible with 3M™ Supplied Air System
No
Compatible with Welding Shield
Ye

3M™ Head Harness Assembly 7581, System Component 20 EA/Case

3M Product Number 7581 3M ID 7000002157 UPC 50051131527534

Details

Approved 3M™ replacement part
Designed for use with 3M™ Half Facepiece 7500 Series (sold separately)
Easy installation allows for quick replacement
Head harness assembly can extend service life of facepiece
Replaceable part can potentially result in respiratory equipment cost savings

Typical properties

Accessories
No
Brands
3M™
Case Quantity
5/bag
Clip-on Welding Shield
No
Compatible Respirator
7500 Series
Compatible with 3M™ PAPR Systems
No
Compatible with 3M™ Supplied Air System
No
Compatible with Welding Shield
No
Cool Flow™ Exhalatio

3M™ Head Harness FF-400-04, 5 EA/Case

3M Product Number FF-400-04 3M ID 7100003369 UPC 50051135894762

Details

Replacement part to use with 3M Ultimate FX Full Facepiece Reusable Respirators FF-401, FF-402, and FF-403 (sold separately)
Designed for use with the 3M Ultimate FX Full Facepiece Reusable Respirators (sold separately)
Maintains original performance standards of facepiece
Single head harness replacement
Replaceable part can potentially result in respiratory equipment cost savings

Typical properties

Accessories
Yes
Boxes per Case
5
Brands
3M™
Case Quantity
5/case
Clip-on Welding Shield
No
Compatible with 3M™ PAPR Systems
No
Compatible with 3M™ Supplied Air System
Yes
Compatible with Welding Shield
No
Cool Flow™ Exhalation Valve
Yes

3M™ Head Harness Assembly 6281, 20 EA/Case

3M Product Number 6281 3M ID 7000029677 UPC 50051138765670

Details

Approved 3M™ replacement part
Designed for use with 3M™ Half Facepiece 6000 Series (sold separately)
Easy installation allows for quick replacement
Head harness assembly can extend service life of facepiece
Replaceable part can potentially result in respiratory equipment cost savings

Typical properties

Accessories
No
Brands
3M™
Case Quantity
5/bag
Clip-on Welding Shield
No
Compatible Respirator
6000 Series
Eye Protection
No
Material
Polyester Film
Product Code
6281
Product Color
Gray
Product Series
6000
Product Type
Accessory & Spar

3M™ Secure Click™ Head Harness Assembly for HF-800 Series Respirators with Speaking Diaphragm, HF-800-04, 5 EA/Case

3M Product Number HF-800-04 3M ID 7100217704 UPC 04054596787810

Details

Approved 3M™ replacement part designed for use with 3M™ Secure Click™ Half Facepiece Respirators HF-801, HF-802 and HF-803 (sold separately)
Helps maintain regulatory performance requirements of respirator
Easy installation allows for quick replacement
Head harness assembly can extend service life of facepiece

Typical properties

Accessories

No

Brands

Secure Click™

Case Quantity

5

Clip-on Welding Shield

No

Compatible Respirator

Secure Click™ HF-800 Series Half Facepiece Reusable Respirators

Compatible with 3M™ PAPR Systems

No

Compatible with 3M™ Supplied Air System

No

Dimensions and Classifications

Overall Height (Imperial)

4.76 in

Overall Height (Metric)

121 mm

Overall Length (Imperial)

1.71 in

Overall Length (Metric)

43.4 mm

Overall Width (Imperial)

4.91 in

Overall Width (Metric)

124.7 mm

3M™ Speedglas™ Heavy-Duty Welding Helmet G5-01, Rigid Neck Cover, Fabric Head Cover, No ADF, 46-0099-35, 1 EA/Case

Part Number 56FE38 3M Product Number 46-0099-35 3M ID 7100259574

Details

Available 3M™ Speedglas™ Welding Lens G5-01TW offers variable dark shades 5, 8-13 and tack welding comfort mode and G5-01VC offers variable dark shades 5, 8-14 plus Variable Color Technology

The big (104 x 170 mm), clear protective visor is curved, with excellent views up, down and peripherally

For more control over your comfort, the innovative G5-01 helmet airflow optimization system lets you direct the airflow to either your face, visor or somewhere in-between

The slim profile and ergonomic design makes the G5-01 helmet easier to utilize in tight welding spaces

Suitable for most types of arc welding

Typical properties

Brands

Speedglas™

Breathing Tube Grade

Heavy Duty

Case Quantity

1

Comes with Auto-Darkening Filter (ADF)

No

Lens Type

No Lens

Product Color

Black

Product Series

G5

Recommended Application

Grinding, Metal Processing, Metal Repair, Welding

R

3M™ DBI-SALA® FlexiGuard™ M200 Jack Stabilizing, 8530907, 1Kit

3M Product Number 8530907 3M ID 7100296911

Details

Designed to stabilize and level counterweight base systems
Removable for ease of transport and storage
Recommended with M200 counterweight base systems

Typical properties

Brands
DBI-SALA®
Connected Safety ID Equipped
No
Install Type
Temporary/Portable
Manufacturing Origin
Mexico
Mounting Type
Surface
Net Weight (Imperial)
108 lb
Net Weight (Metric)
48.99 kg
Product Series
M200
Product Type
Modular Jib Acce

Dimensions and Classifications

Overall Height (Metric)
0 mm
Overall Length (Metric)
0 mm
Overall Width (Metric)
0 mm

3M™ DBI-SALA® Rollgliss™ Rescue Pole 8900298, Silver and Red, 4 ft. to 16 ft. (1.2 to 4.9 m)

Part Number 8900298 3M Product Number 8900298 3M ID 7100226854

Details

Rescue pole designed for assisted rescue of worker after fall
Compact, lightweight aluminum construction built for fast and efficient rescue
No special tools or training required
Oversized connection hook with 2.25 inch (5.7 cm) gate opening
3 in. (76 mm) diameter pole adjusts from 4 ft. to 16 ft. (1.2 m to 4.9 m)
Recommended for use in construction, mining, oil and gas, transportation, utilities, and general industrial applications
Perfect for use with the Rollgliss™ R550 rescue and descent device
Carrying bag included

Typical properties

Brands
DBI-SALA®
Case Quantity
1
CoWorker Controlled Ascent
Yes
CoWorker Controlled Descent
Yes
Connected Safety ID Equipped
No
Descent Type
Vertical
Dimensions
(50.00x3.00x3.00)in
Lanyard Material
Web
Maximum Number of Users
One
Product

Dimensions and Classifications

Overall Length (Imperial)
4 ft

3M™ Secure Click™ Full Facepiece Reusable Respirator FF-802, Medium, 4 EA/Case

Part Number FF-802 3M Product Number FF-802 3M ID 7100261326

Details

The quick, easy, one-touch positive pressure push button seal check helps provide improved confidence in respirator fit

Two dual-flow cartridges on each respirator combine to create the world's first quad flow cartridge systems with four airflow paths providing easy breathing and comfort

Large lens for excellent field of vision, and treated with Scotchgard™ Protector for improved paint and stain resistance

Six-strap harness helps provide a secure comfortable fit

Speaking diaphragm is designed to help provide easy communication

The FF-800 Series meets the requirements of ANSI Z87.1-2015 standard for eye and face protection

NIOSH, a Federal government regulatory agency, has tested and approved the FF-800 with 3M Secure Click cartridges and filters

Recommended applications include assembly, chemical clean-up, chemical handling, chipping, chiseling, cleaning, furnace operations, grinding, machining, masonry, painting, pouring/casting, sanding and sawing

Typical properties

Accessories

Yes

Assigned Protection Factor

50 Quantitative Fit Test

Brands

Secure Click™

Cartridge or Filter Included

No

Case Quantity

4

Clip-on Welding Shield

No

Compatible with 3M™ PAPR Systems

No

Compatible with 3M™ Supplied Air System

N

3M™ Secure Click™ Full Facepiece Reusable Respirator FF-803, Large, 4 EA/Case

Part Number FF-803 3M Product Number FF-803 3M ID 7100261328

Details

The quick, easy, one-touch positive pressure push button seal check helps provide improved confidence in respirator fit

Two dual-flow cartridges on each respirator combine to create the world's first quad flow cartridge systems with four airflow paths providing easy breathing and comfort

Large lens for excellent field of vision, and treated with Scotchgard™ Protector for improved paint and stain resistance

Six-strap harness helps provide a secure comfortable fit

Speaking diaphragm is designed to help provide easy communication

The FF-800 Series meets the requirements of ANSI Z87.1-2015 standard for eye and face protection

NIOSH, a Federal government regulatory agency, has tested and approved the FF-800 with 3M Secure Click cartridges and filters

Recommended applications include assembly, chemical clean-up, chemical handling, chipping, chiseling, cleaning, furnace operations, grinding, machining, masonry, painting, pouring/casting, sanding and sawing

Typical properties

Accessories

Yes

Assigned Protection Factor

50 Quantitative Fit Test

Brands

Secure Click™

Cartridge or Filter Included

No

Case Quantity

4

Clip-on Welding Shield

No

Compatible with 3M™ PAPR Systems

No

Compatible with 3M™ Supplied Air System

N

3M™ DBI-SALA® Assisted Rescue Web Pick-Off Strap 1200174, 4 ft

Part Number 1200174 3M Product Number 1200174 3M ID 7100268008

Details

Hardware kit for sloped high speed Rollgliss™ Descender
Suspension bars connect descender to guide cable
Braking trolley with snap hook for more control during descent
Designed to be compact and lightweight
Corrosion-resistant steel construction
Recommended for use in construction, oil and gas, and general industrial applications
11.2 lb. (5.1 kg)

Typical properties

Brands
DBI-SALA®
Lanyard Length (Imperial)
4 in
Product Series
Rollgliss™
Weight Capacity (Imperial)
310 lb.
Weight Capacity (Metric)
140 kg

3M™ DBI-SALA® Rollgliss™ Anchorage Plate For Rescue Ladder 8516316

Part Number 8516316 3M Product Number 8516316 3M ID 7012595693

Details

Hardware kit for sloped high speed Rollgliss™ Descender
Suspension bars connect descender to guide cable
Braking trolley with snap hook for more control during descent
Designed to be compact and lightweight
Corrosion-resistant steel construction
Recommended for use in construction, oil and gas, and general industrial applications
11.2 lb. (5.1 kg)

Typical properties

Brands
DBI-SALA®
Case Quantity
1
CoWorker Controlled Ascent
Yes
CoWorker Controlled Descent
Yes
Connected Safety ID Equipped
No
Descent Type
Vertical
Maximum Number of Users
One
Product Color
Black
Product Series
Rollgliss™
Product Type

Dimensions and Classifications

Overall Length (Imperial)
8 ft

3M™ DBI-SALA® Rollgliss™ Bucket Truck Rescue Descender 3304001, Polyester Web, 55 ft

3M ID 7012818864

Details

Hardware kit for sloped high speed Rollgliss™ Descender
Suspension bars connect descender to guide cable
Braking trolley with snap hook for more control during descent
Designed to be compact and lightweight
Corrosion-resistant steel construction
Recommended for use in construction, oil and gas, and general industrial applications
11.2 lb. (5.1 kg)

Typical properties

Product Series
Rollgliss™

3M™ Protecta® Shock Absorbing Lanyard for Hot Work Use 1340185, 6ft (1.8m), 1 ea

Part Number 1340185 3M Product Number 1340185 3M ID 7100218778

Details

Fire resistant Kevlar® fiber webbing
PVC shock pack with Kevlar® fiber cover (not sure this is true since the part # is not provided)
Energy absorbing design limits fall arrest forces
Impact indicator

Typical properties

Anchor Connection Type
Rebar Hook
Anchor Hook Material
Zinc Plated Steel
Brands
PROTECTA®
Case Quantity
1
Connected Safety ID Equipped
No
Energy Absorber Class
6 ft (1.8 m) Free Fall/MAAF 900 lbs. (4 kN)
For Use With
Hot Work Use
Harness Con

Dimensions and Classifications

Overall Length (Imperial)
6 ft

3M™ DBI-SALA® Flexiguard™ Counterweight Base Hoist Ring Kit 8530777, 5000 lb, 4 ea/Pack

3M Product Number 8530777 3M ID 7100306797 UPC 00648250192948

Details

Enables M200 counterweight box to be moved with overhead lifting equipment
Designed to enable easy system transport
Improves system mobility to help maximize usage in various locations

Typical properties

Brands
DBI-SALA®
Connected Safety ID Equipped
No
Install Type
Temporary/Portable
Manufacturing Origin
USA
Maximum Height (Imperial)
6.36 in
Maximum Height (Metric)
16.15 cm
Minimum Height (Imperial)
6.36 in
Minimum Height (Metric)
16.15 cm

Dimensions and Classifications

Overall Height (Metric)
0 mm
Overall Length (Metric)
0 mm
Overall Width (Metric)
0 mm

3M™ DBI-SALA® Rope Carrying Bag 8700225, PVC Vinyl, Yellow, 8 in x 7.5 in x 25 in

3M Product Number 8700225 3M ID 7012821057 UPC 00648250170519

Details

- Small heavy duty 25L rope bag
- Versatile carry handles
- Stiffened rim for easy access
- Secure closure system
- Internal gear pocket
- Clear plastic external pocket
- Drainage and ventilation grommets in base
- Top and bottom haul loops
- Internal gear loop
- Colour coded sizing
- Available in a range of sizes

Typical properties

- Brands
 - DBI-SALA®
- Case Quantity
 - 1
- CoWorker Controlled Ascent
 - No
- CoWorker Controlled Descent
 - No
- Connected Safety ID Equipped
 - No
- Dimensions
 - 700.00x200.00xmm
- Product Color
 - Yellow
- Product Series
 - Rollgliss™
- Product Type
 - Rope Bag
- Recommended In

3M™ Virtua™ Sport CCS Protective Eyewear 11796-00000-20 Clear Anti-Fog Lens, 20 EA/Case

3M Product Number 11796-00000-20 3M ID 7010340677 UPC 10078371117969

Details

Clear lens
Blue temples
Polycarbonate lens absorbs 99.9% UV
Meets the High Impact Requirements of ANSI Z87.1-2015
20 safety glasses per case

Typical properties

Anti Fog Lens
Yes
Brands
Virtua™
Case Quantity
20
Class
Economy
Comfort Features
Cord Control System Temples for Earplug Attachment, Lightweight, Wraparound lens
Diopter
0
Eyewear Range
Economy
Frame Color
Clear
Frame Material
Plastic
Fr

3M™ Virtua™ Sport CCS Protective Eyewear 11798-00000-20 Corded Control System, Gray Anti-Fog Lens, 20 EA/Case

3M Product Number 11798-00000-20 3M ID 7010384246 UPC 10078371117983

Typical properties

Anti Fog Lens

Yes

Brands

Virtua™

Case Quantity

20

Class

Economy

Comfort Features

Cord Control System Temples for Earplug Attachment, Lightweight, Wraparound lens

Diopter

0

Eyewear Range

Economy

Frame Color

Black

Frame Material

Plastic

Fr

3M™ DBI-SALA® Confined Space Rescue Davit System with Winch 8302500, Technora Rope, 50 ft

Part Number 8302500 3M Product Number 8302500 3M ID 7100231963

Details

Designed for rescue, retrieval, and descent applications only
Includes 2-piece rescue davit system with folding base and arm
Includes 50 ft. (15.2 m) synthetic rope winch
Weight: 76.2 lbs. (34.6 kg)

Typical properties

Anchor Install Type
Reusable
Brands
DBI-SALA®
Carabiner/Hook Material
Zinc Plated Steel
Case Quantity
1
Connected Safety ID Equipped
No
Install Type
Portable
Lifeline Material
Technora Rope
Material
Aluminum
Net Weight (Imperial)
76.2 lb

Dimensions and Classifications

Overall Length (Imperial)
50 ft

3M™ DBI-SALA® Nano-Lok™ Connected Extended Length Order Picker Self-Retracting Lifeline 2000037, Web, 11 ft

3M Product Number 2000037 3M ID 7100264409 UPC 00648250179376

Details

SRL that pairs with visual and audible alert system designed to inform worker and surrounding area when an operator is not tied off
Dual sensing hook that detects if the hook gate is fully closed and locked
Works with all metallic OSHA rated dorsal D-Ring's
Lightweight aluminum snap hook with plastic cover
Dynema™ fiber and polyester web lifeline
Swiveling anchorage loop
Self-retracting lifeline only

Typical properties

Anchor Connection Type
Cab-mount Bracket
Anchor Hook Material
Stainless Steel
Attachment Type
Bolt and Clamp-On
Brands
DBI-SALA®
Carabiner/Hook Material
Aluminum
Case Quantity
1.0 per Case
Connected Safety ID Equipped
Yes
Harness Connection

3M™ PELTOR™ Professional In Ear Communication Headset PIC-100 NA, 20 ea/Case

3M Product Number PIC-100 NA 3M ID 7100262767 UPC 00638060433164

Details

In-ear protective communication solution for hands-free, clear communication in noisy environments

On-demand fit test provides the wearer's current personal attenuation rating (PAR) to help ensure adequate protection with each fit

Speech microphones in the earpieces pick up your voice, eliminating the need for a traditional boom microphone

The in-ear speech-communication microphone enables compatibility with a variety of personal protective equipment such as helmets/hard hats, eye wear, and respirators

Bluetooth® technology for connection to external devices

Close-connect wireless technology enables close-proximity, headset-to-headset communication

Six separate Close-connect channels enable different groups to communicate in close proximity without interference

Environmental listening technology assists workers to hear environmental sounds in low noise and helps provide protection when it's loud

Replaceable eartips in multiple types and sizes

The PIC-100 introduces multiple innovative technologies to help workers stay protected and productive

Typical properties

Attenuation Rating

27 dB,33 dB,21 dB

Audio Type

Communication

Battery Life

Approx. 16 Hours

Battery Type

Lithium-ion Rechargeable

Bluetooth

Yes

Brands

PELTOR™

Case Quantity

20

Communication Direction

Two-way

Communication Type

Ambient Lis

3M™ Double Locking Swiveling Snap Hook 9502195, Zinc Plated Steel, 3600 lb Gate, 0.75 in Throat

3M Product Number 9502195 3M ID 7100312726

Details

- User friendly compact design
- Variable width gate opening steel or aluminum carabiner
- Versatility of attachment to fall protection systems
- Corrosion-resistant
- Available in multiple sizes and shapes
- Recommended for mining, oil and gas, utilities, wind energy, and general industrial applications
- Meets the requirements of EN362 and ANSI/ASSP 359.12-2019
- High-strength steel or aluminum construction
- Durable and lightweight

Typical properties

Brands
3M™

3M™ DBI-SALA® Confined Space Aluminum Ladder Section 8518507, 8 ft

Part Number 8518507 3M Product Number 8518507 3M ID 7012820786

Details

Aluminum ladder
Built-in connector channels and pin locks
Connect up to 5 sections together
Lightweight, durable aluminum construction
Bracket available to attach ladder to confined space system (model 8518506)

Typical properties

Brands
DBI-SALA®
Case Quantity
1
Connected Safety ID Equipped
No
Dimensions
13.00x2.50x103.00in
Net Weight (Imperial)
19.6 lb
Recommended Industry
Construction, General Industrial, Mining, Oil & Gas, Transportation, Utilities
Weight (Imperial)

Dimensions and Classifications

Overall Length (Imperial)
8 ft

3M™ Dual Airline Back-Mounted Adapter Kit SA-2000LP, Low Pressure 1 EA/Case

3M Product Number SA-2000LP 3M ID 7100010250

Details

This kit, with facepiece, filters/cartridges and air hose makes a 3M™ Dual Airline Supplied Air Respirator

Typical properties

Brands

3M™

Breathing Tube Type

Back-Mounted

CFM Capacity per Minute

100 CFM, 50 CFM

Cartridge or Filter Included

No

Case Quantity

1/pack

Coupling Size

0.25" MPT, 3/8" Body Size, Industrial Interchange

Fitting Type

Industrial Interchange

Hose

3M™ Dual Airline Back-Mounted Adapter Kit SA-2000 1 EA/Case

3M Product Number SA-2000 3M ID 7000126161

Details

Includes 3M™ Breathing Tube SA 2500, 3M™ Waist Belt GVP 127 and 3M™ Valve SA 1009

Typical properties

Brands

3M™

CFM Capacity per Minute

100 CFM, 50 CFM

Cartridge or Filter Included

No

Case Quantity

1/pack

Compatible With

3M™ Supplied Air Systems

Coupling Size

0.25" MPT, 0.25" Body Size, Industrial Interchange

Fitting Type

Industrial Intercha

3M™ Secure Click™ Filter Retainer D701, 100 EA/Case

3M Product Number D701 3M ID 7100184498 UPC 50689330179133

Details

Designed to hold 3M™ Secure Click™ Particulate Filters D7N11 and D7P71
Works with 3M™ Secure Click™ Cartridges D8000 Series
Allows for replacement of filters prior to change out of cartridges for cost savings
Use one D701 filter retainer per D8000 Series cartridge
For workplace/occupational use only
Package contents: 1 case contains 100 each of filter retainers

Typical properties

Accessories

No

Brands

Secure Click™

Case Quantity

100

Clip-on Welding Shield

No

Compatible Respirator

Secure Click™ HF-800 Series Full Facepiece Reusable Respirators

Compatible with 3M™ PAPR Systems

No

Compatible with 3M™ Supplied Air System

Dimensions and Classifications

Overall Height (Metric)

1 mm

Overall Length (Metric)

18 mm

Overall Width (Metric)

9 mm

3M™ DBI-SALA® Nano-Lok™ edge Personal Self-Retracting Lifeline 3500293, Galvanized Cable, 8 ft

3M Product Number 3500293 3M ID 7012828694 UPC 00648250243619

Details

- Designed for foot-level tie-off and leading edge applications
- Compact Design
- Quick activating speed sensing brake system
- Durable thermoplastic housing
- Built-in connector for direct attachment to harness
- High capacity external energy absorber and impact indicator
- RFID equipped and compatible with inventory management system
- Available in multiple styles and configurations

Typical properties

- ANSI Class Level
- Class 2
- Average Arrest Force (Imperial)
- 900 lbf (ANSI), 900 lbf (OSHA 130 lb - 310 lb)
- Average Arrest Force (Metric)
- 4 kN (ANSI), 4 kN (OSHA 130 lb - 310 lb)
- Brands
- DBI-SALA®
- Connected Safety ID Equipped
- Yes
- Harness Connection H

Dimensions and Classifications

- Overall Length (Imperial)
- 8 ft
- Overall Length (Metric)
- 2.4 m

3M™ Cap Suspension H-213-2/37117(AAD) 2 EA/Case

3M Product Number H-213-2 3M ID 7000126541 UPC 50051131371175

Details

For use with 3M™ Hoods H-Series

Typical properties

Brands

3M™

Compatible With

3M™ H-Series Headgear

Headgear Type

Hood

High Heat

No

Product Series

H-Series

Product Type

Suspension

Recommended Industry

Marine

3M™ Exhalation Valve 6889/07143(AAD), 10 ea/Bag

3M Product Number 6889 3M ID 7000002057 UPC 50051131071433

Details

Approved 3M replacement part
Recommended for 3M Half Facepiece Respirator 6000 Series (sold separately)
Replacement part can extend service life of facepiece
Replaceable part can potentially result in respiratory equipment cost savings
Valve maintains original service performance of facepiece

Typical properties

Accessories
No
Brands
3M™
Case Quantity
1/pack
Clip-on Welding Shield
No
Compatible Respirator
6000 Series
Compatible with 3M™ PAPR Systems
No
Compatible with 3M™ Supplied Air System
No
Compatible with Welding Shield
No
Cool Flow™ Exhalati

3M™ Rugged Comfort 6583 / 55888 Exhalation Valve, System Component

3M Product Number 6583 3M ID 7000128253 UPC 00051141558882

Details

Enhanced comfort by reducing heat and moisture - Easier breathing with unique valve design

Replacement part for the 3M™ 6500 Series

10 each per case

For occupational use only

Typical properties

Accessories

No

Brands

3M™

Case Quantity

10/Bag

Clip-on Welding Shield

No

Compatible Respirator

6500 Series

Compatible with 3M™ PAPR Systems

No

Compatible with 3M™ Supplied Air System

No

Compatible with Welding Shield

Yes

Connection Type

B

3M™ Secure Click™ Particulate Filter P95 D7P71, 200 EA/Case

3M Product Number D7P71 3M ID 7100213434 UPC 50051131278108

Details

Works with 3M™ Secure Click™ Cartridges D8000 Series
Held in place by required 3M™ Secure Click™ Filter Retainer D701
NIOSH-approved P95 particulate filter for respiratory protection against certain oil and non-oil based particulates
Allows for replacement of filters prior to change out of cartridges for cost savings
Use two D7P71 filters per D8000 Series cartridge for a total of four filters per facepiece
For workplace/occupational use only
Package contents: 1 case contains 10 boxes of 20 filter each (200 each total)

Typical properties

Accessories
No
Brands
Secure Click™
Cartridge or Filter Type
Particulate
Clip-on Welding Shield
No
Compatible Respirator
3M™ Secure Click™ Half Facepiece Reusable Respirators HF-800 Series
Compatible with 3M™ PAPR Systems
No
Compatible with 3M

Dimensions and Classifications

Overall Height (Metric)
5 mm
Overall Length (Metric)
81 mm
Overall Width (Metric)
85 mm

3M™ Inhalation Port TR-654 Replacement Gaskets for TR-653 Cleaning and Storage Kit, 20/Bag, 4 Bags EA/Case

3M Product Number 6895 3M ID 7000002050 UPC 50051131071457

Details

Approved 3M™ replacement part
Gasket helps provide a seal between facepiece and cartridge or filter
Designed for 3M Half and Full Facepiece Respirator 6000 and 7800 Series (sold separately)
Replaceable part can potentially result in respiratory equipment cost savings

Typical properties

Accessories
Yes
Brands
3M™
Case Quantity
20/pack
Clip-on Welding Shield
Yes
Compatible Respirator
6000 Series
Compatible with 3M™ PAPR Systems
Yes
Compatible with 3M™ Supplied Air System
Yes
Compatible with Welding Shield
No
Cool Flow™ Exh

3M™ Center Adapter Gasket 6896, 20 EA/Case

Part Number 76624 3M Product Number 6896 3M ID 7000052122

Details

Approved 3M™ replacement part
Designed for use with 3M™ Full Facepiece 6000 Series (sold separately)
Use to seal 3M™ Center Adapter Assembly 6892 (sold separately) or 3M DIN
Port Adapter Assembly 6884 (sold separately) to facepiece
Replacement center adapter gasket can extend service life of facepiece
Replaceable part can potentially result in respiratory equipment cost savings

Typical properties

Accessories
No
Boxes per Case
20
Brands
3M™
Case Quantity
20/case
Clip-on Welding Shield
No
Compatible Respirator
6000 Series
Compatible with 3M™ PAPR Systems
Yes
Compatible with 3M™ Supplied Air System
Yes
Eye Protection
No
Material
Si

3M™ Versaflo™ Forehead Comfort Pad/Sweat Pad M-957/L-115/37010(AAD), 10 EA/Case

3M Product Number M-957/L-115 3M ID 7100043088 UPC 00051131370104

Details

Used on any 3M™ Versaflo™ M-Series Headgear, 3M™ L-Series Headgear, H-Series Hood, and Whitecap™ Helmets

Typical properties

Brands
Versaflo™
Cartridge or Filter Included
N/A
Case Quantity
10
Compatible With
3M™ Whitecap Helmets
Headgear Type
Headcover
High Heat
No
Product Color
Orange
Product Series
M-Series, Whitecap
Product Type
Comfort Pad
Recommended Indu

3M™ PELTOR™ Earmuff Probed Test Cushion #35, 393-3004-2, 2PR/CS

3M Product Number 393-3004-2 3M ID 7100123728 UPC 10078371670907

Details

Easily snaps into employee's own earmuffs enabling fit test. Adapter clips hold microphone next to earmuff for proper positioning during testing
Probed cushions can be cleaned with hygiene wipes and reused
Adapter clips hold microphones next to earmuffs during testing
*The NRR may overestimate the hearing protection provided during typical use

Typical properties

Brands
PELTOR™
Case Quantity
2
Product Type
Probed Test Cushion
Recommended Application
Health & Safety Testing
eClass 14 Classification Group
40270102

3M™ PELTOR™ X3 Earmuff Probed Test Cushions 393-3003-2, 2 EA/Case

3M Product Number 393-3003-2 3M ID 7100062127 UPC 00078371668358

Details

Easily snaps into employee's own earmuffs enabling fit test. Adapter clips hold microphone next to earmuff for proper positioning during testing
Probed cushions can be cleaned with hygiene wipes and reused
Adapter clips hold microphones next to earmuffs during testing
*The NRR may overestimate the hearing protection provided during typical use

Typical properties

Brands
PELTOR™
Case Quantity
2
Product Color
Black
Product Series
X Series
Product Type
Probed Test Cushion
Recommended Application
Health & Safety Testing
Recommended Industry
Automotive, Commercial Buildings, Construction, Design & Construc

3M™ PELTOR™ X4/X5 Earmuff Probed Test Cushions 393-3005-2, 2 EA/Case

3M Product Number 393-3005-2 3M ID 7100062128 UPC 00078371668365

Details

Easily snaps into employee's own earmuffs enabling fit test. Adapter clips hold microphone next to earmuff for proper positioning during testing
Probed cushions can be cleaned with hygiene wipes and reused
Adapter clips hold microphones next to earmuffs during testing
*The NRR may overestimate the hearing protection provided during typical use

Typical properties

Brands
PELTOR™
Product Type
Probed Test Cushion
eClass 14 Classification Group
40270102

3M™ Rugged Comfort Quick Latch Half Facepiece Reusable Respirator 6502QL/49490, Medium, 10 EA/Case

3M Product Number 6502QL 3M ID 7000128239 UPC 50051131494904

Details

Recommended industries include construction, general manufacturing, heavy infrastructure, industrial maintenance, mining, oil and gas, transportation, and more

Use with 3M™ Particle Filters 2000, 2200, 7000, or 5000 Series to filter certain particulates

Use with 3M 6000 Series Gas/Vapor Cartridges to help filter a broad range of gases and vapors

Use with 3M 6000 Series Combination Cartridges to help filter particulates in addition to gases and vapors

Compatible with 3M™ TR-600 and TR-800 powered air purifying respirators against a variety of gases, vapors, and particulate hazards

Silicone face seal keeps its shape even in hot work conditions

Low-profile half facepiece design is compatible with many welding and grinding shields

For workplace/occupational use only

Typical properties

Accessories

No

Assigned Protection Factor

10

Brands

3M™

Case Quantity

10/case

Clip-on Welding Shield

No

Compatible With

Line Compressed Air System SA Series

Compatible with 3M™ PAPR Systems

No

Compatible with 3M™ Supplied Air System

No

Com

3M™ Rugged Comfort Quick Latch Half Facepiece Reusable Respirator 6501QL/49488, Small, 10 EA/Case

3M Product Number 6501QL 3M ID 7000128237 UPC 50051131494881

Details

Recommended industries include construction, general manufacturing, heavy infrastructure, industrial maintenance, mining, oil and gas, transportation, and more

Use with 3M™ Particle Filters 2000, 2200, 7000, or 5000 Series to filter certain particulates

Use with 3M 6000 Series Gas/Vapor Cartridges to help filter a broad range of gases and vapors

Use with 3M 6000 Series Combination Cartridges to help filter particulates in addition to gases and vapors

Compatible with 3M™ TR-600 and TR-800 powered air purifying respirators against a variety of gases, vapors, and particulate hazards

Silicone face seal keeps its shape even in hot work conditions

Low-profile half facepiece design is compatible with many welding and grinding shields

For workplace/occupational use only

Typical properties

Accessories

No

Assigned Protection Factor

10

Brands

3M™

Case Quantity

10/case

Clip-on Welding Shield

No

Compatible With

Line Compressed Air System SA Series

Compatible with 3M™ PAPR Systems

No

Compatible with 3M™ Supplied Air System

No

Com

3M™ Speedglas™ G5-02 Magnification Plate 08-0500-56, 1.5X

Part Number 08-0500-56 3M Product Number 08-0500-56 3M ID 7100239738

Details

Magnifies objects by 1.5 times the normal power and is designed for use with the 3M™ Speedglas™ Welding Helmet G5-02

No extra lens holder needed, just attach to the G5-02 inner protection plate, making lens installation easier and more secure

Position can be adjusted vertically in five steps for optimized view of your work piece

Typical properties

Brands

Speedglas™

Case Quantity

1/Case

Compatible Welding Helmet

G5-02 Welding Helmets

Features

Magnification Plate

For Use With

G5-02 Welding Helmets

Magnification Level

1.5X

Product Series

G5

Product Type

Magnification Plate

Recommended

3M™ Speedglas™ G5-01 Airduct Breathing Tube, with Holder, 46-0400-57, 1 EA/Case

3M Product Number 46-0400-57 3M ID 7100215556 UPC 00076308944513

Details

Spare part for 3M™ Speedglas™ Heavy-Duty Welding Helmet G5-01
To be ordered if the air duct breathing tube and/or holder has become damaged and needs replacement
For maximum safety and comfort, make it a habit to check your equipment regularly

Typical properties

Brands
Speedglas™
Case Quantity
1 EA/Case
Compatible Welding Helmet
G5-01 Welding Helmets
Product Color
Black
Product Series
G5
Product Type
Breathing Tube
Recommended Application
Grinding, Metal Processing, Metal Repair, Welding
Recommended

3M™ Secure Click™ Organic Vapor/Acid Gas Cartridge/Filter P100 D80923, 60 ea/Case

3M Product Number D80923 3M ID 7100153233 UPC 00051141566788

Details

Secure Click™ connection style enables a quick, simple connection of cartridges/filters

Secure Click™ cartridges/filters are dual-flow to allow easy breathing and greater comfort

Use with NIOSH-approved 3M™ Secure Click™ Facepieces

NIOSH-approved for protection against certain organic vapors, chlorine, hydrogen chloride/sulfur dioxide, or chlorine dioxide or hydrogen sulfide

NIOSH-approved P100 particulate filter for respiratory protection against certain oil and non-oil based particulates

Swept-back design for enhanced field of view and comfort

For workplace/occupational use only

Package contents: 1 case contains 30 pairs of filters (60 each)

Typical properties

Accessories

No

Brands

Secure Click™

Cartridge or Filter Type

Combination

Clip-on Welding Shield

No

Compatible Respirator

3M™ Secure Click™ Half Facepiece Reusable Respirators HF-800 Series

Compatible with 3M™ PAPR Systems

No

Compatible with 3M

Dimensions and Classifications

Overall Height (Metric)

34 mm

Overall Length (Metric)

121 mm

Overall Width (Metric)

93 mm

3M™ Secure Click™ Organic Vapor Cartridge/Filter P100 D80921, 60 ea/Case

3M Product Number D80921 3M ID 7100153232 UPC 00051141566764

Details

Secure Click™ connection style enables a quick, simple connection of cartridges/filters

Secure Click™ cartridges/filters are dual-flow to allow easy breathing and greater comfort

Use with NIOSH-approved 3M™ Secure Click™ Facepieces

NIOSH-approved for use against certain organic vapors

NIOSH-approved P100 particulate filter for respiratory protection against certain oil and non-oil based particulates

Swept-back design for enhanced field of view and comfort

For workplace/occupational use only

Package contents: 1 case contains 30 pairs of filters (60 each)

Typical properties

Accessories

No

Brands

Secure Click™

Cartridge or Filter Type

Gas & Vapor

Clip-on Welding Shield

No

Compatible Respirator

3M™ Secure Click™ Half Facepiece Reusable Respirators HF-800 Series

Compatible with 3M™ PAPR Systems

No

Compatible with 3M

Dimensions and Classifications

Overall Height (Metric)

34 mm

Overall Length (Metric)

121 mm

Overall Width (Metric)

93 mm

3M™ Secure Click™ Multi-Gas/Vapor Cartridge/Filter P100 D80926, 60 ea/Case

3M Product Number D80926 3M ID 7100153234 UPC 00051141566818

Details

Secure Click™ connection style enables a quick, simple connection of cartridges/filters

Secure Click™ cartridges/filters are dual-flow to allow easy breathing and greater comfort

Use with NIOSH-approved 3M™ Secure Click™ Facepieces

NIOSH-approved for protection against certain organic vapors, sulfur dioxide, hydrogen chloride, chlorine/ammonia/methylamine/formaldehyde or chlorine dioxide or hydrogen fluoride or hydrogen sulfide

NIOSH-approved P100 particulate filter for respiratory protection against certain oil and non-oil based particulates

Swept-back design for enhanced field of view and comfort

For workplace/occupational use only

Package contents: 1 case contains 30 pairs of filters (60 each)

Typical properties

Accessories

No

Brands

Secure Click™

Cartridge or Filter Type

Combination

Clip-on Welding Shield

No

Compatible Respirator

3M™ Secure Click™ Half Facepiece Reusable Respirators HF-800 Series

Compatible with 3M™ PAPR Systems

No

Compatible with 3M

Dimensions and Classifications

Overall Height (Metric)

34 mm

Overall Length (Metric)

121 mm

Overall Width (Metric)

93 mm

3M™ Versaflo™ Replacement Visor Frame Assembly M-920/37320(AAD), 1 EA/Case

3M Product Number M-920 3M ID 7000127687 UPC 00051131373204

Details

Replacement part for 3M™ Versaflo™ M-Series products

Typical properties

Brands

Versaflo™

Case Quantity

1

Compatible With

3M™ Versaflo™ M-Series Helmet

Headgear Type

Headcover

High Heat

No

Product Color

Gray

Product Series

M-Series

Product Type

Faceshield

Recommended Industry

Marine

3M™ Nose Cup Assembly FF-400-11, 5 EA/Case

3M Product Number FF-400-11 3M ID 7000052741 UPC 50051135894830

Details

Replacement part to use with 3M Ultimate FX Full Facepiece Reusable Respirators FF-401, FF-402, and FF-403 (sold separately)
Designed for use with the 3M Ultimate FX Full Facepiece Reusable Respirators (sold separately)
Maintains original performance standards of facepiece
Replaceable part can potentially result in respiratory equipment cost savings
Replacement assembly for standard nose cup

Typical properties

Accessories
Yes
Boxes per Case
5
Brands
3M™
Case Quantity
5/case
Clip-on Welding Shield
No
Compatible Respirator
FF-400 Series
Compatible with 3M™ PAPR Systems
No
Compatible with 3M™ Supplied Air System
Yes
Compatible with Welding Shield

3M™ Nose Cup Assembly 6894/37004(AAD), Replacement Part 5 EA/Case

Part Number 37004 3M Product Number 6894 3M ID 7000002034

Details

Approved 3M replacement part

Recommended for 3M Full Facepieces 6700, 6800, 6900 (07138, 07139, 07140 AAD)

Replacement part can extend respiratory equipment service life

Replaceable nose cup assembly can potentially result in respiratory equipment cost savings

Assembly maintains original service performance of facepiece

Typical properties

Accessories

No

Boxes per Case

5

Brands

3M™

Case Quantity

5/case

Clip-on Welding Shield

No

Compatible Respirator

6000 Series

Eye Protection

No

Material

Thermoplastic Elastomer (TPE)

Product Code

6894

Product Series

6000

Product Type

Re

3M™ Versaflo™ Standard Visor M-925/37323(AAD), 5 EA/Case

Part Number 37323 3M Product Number M-925 3M ID 7000127690

Details

Replace visor for all 3M™ Versaflo™ M-Series products

Typical properties

Brands

Versaflo™

Case Quantity

5

Compatible With

3M™ Versaflo™ M-Series Helmet

Headgear Type

Headcover

High Heat

No

Material

Polycarbonate

Product Color

Transparent

Product Series

M-Series

Product Type

Faceshield

Recommended Application

3M™ BX™ Reader Protective Eyewear 11374-00000-20, Clear Lens, Silver Frame, +1.5 Diopter, 20 ea/Case

3M Product Number 11374-00000-20 3M ID 7000127490 UPC 10078371620469

Details

Molded-in magnifying 1.5+ diopters
Sleek, contoured design combines style and function
Adjustable length temples and lens angle allow for customized fit
Polycarbonate lenses absorb 99.9% UVA and UVB up to 380 nm

Typical properties

ANSI Requirements
ANSI Z87.1-2003 and CSA Z94.3-2007
Anti Fog Lens
No
Brands
BX™
Case Quantity
20
Class
Value
Comfort Features
Adjustable length temples, Adjustable lens angles, Soft adjustable nose bridge
Diopter
1.5
Eyewear Range
Value
F

Dimensions and Classifications

Overall Height (Imperial)
2 in
Overall Height (Metric)
5.08 cm
Overall Length (Imperial)
2 in
Overall Length (Metric)
5.08 cm
Overall Width (Imperial)
2.2 in
Overall Width (Metric)
5.588 cm

3M™ Multi Gas/Vapor Cartridge 6006, 60 ea/Case

Part Number 54186 3M Product Number 6006 3M ID 7000002040

Typical properties

Accessories

Yes

Brands

3M™

Cartridge or Filter Type

Gas & Vapor

Case Quantity

30/case

Clip-on Welding Shield

Yes

Compatible Respirator

3M™ Full Facepieces 6000, 3M™ Full Facepieces 7800 Series, 3M™ Full Facepieces FF-400, 3M™ Half Facepiece Reu

Dimensions and Classifications

Overall Height (Imperial)

3.4 in

Overall Height (Metric)

8.63 cm

Overall Length (Imperial)

4.2 in

Overall Length (Metric)

8.63 cm

3M™ Mercury Vapor/Organic Vapor/Acid Gas Cartridge/Filter 60927, P100, 60 EA/Case

3M Product Number 60927 3M ID 7100198708 UPC 50051131276661

Details

NIOSH-approved for protection against mercury vapor, chlorine, sulfur dioxide, organic vapor and hydrogen sulfide
NIOSH-approved P100 particulate filter for respiratory protection against certain oil and non-oil based particulates
Bayonet connection style for compatibility with many 3M half and full facepiece respirators
Swept-back design for enhanced field of view and comfort
P100 particulate filter is permanently attached to cartridge for easy, one-step assembly

Typical properties

Accessories

No

Brands

3M™

Cartridge or Filter Type

Gas & Vapor/P100

Clip-on Welding Shield

No

Compatible Respirator

3M™ Full Facepieces 6000, 3M™ Full Facepieces 7800 Series, 3M™ Full Facepieces FF-400, 3M™ Half Facepiece Reusable Respirators 600

Dimensions and Classifications

Overall Height (Imperial)

3.39 in

Overall Height (Metric)

86 mm

Overall Length (Imperial)

4.21 in

Overall Length (Metric)

107 mm

3M™ Mercury Vapor/Organic Vapor/Acid Gas Cartridge 6007, 60 EA/Case

3M Product Number 6007 3M ID 7100198706 UPC 50051131276654

Details

NIOSH-approved for protection against mercury vapor, chlorine, sulfur dioxide, organic vapor and hydrogen sulfide

Bayonet connection style for compatibility with many 3M half and full facepiece respirators

Swept-back design for enhanced field of view and comfort

For workplace/occupational use only

Package contents: 1 case contains 30 pairs of cartridges (60 each)

Typical properties

Accessories

No

Brands

3M™

Cartridge or Filter Type

Gas & Vapor

Clip-on Welding Shield

No

Compatible Respirator

3M™ Full Facepieces 6000, 3M™ Full Facepieces 7800 Series, 3M™ Full Facepieces FF-400, 3M™ Half Facepiece Reusable Respirators 6000 Ser

Dimensions and Classifications

Overall Height (Imperial)

3.39 in

Overall Height (Metric)

86 mm

Overall Length (Imperial)

4.21 in

Overall Length (Metric)

107 mm

3M™ Ammonia Methylamine Cartridge 6004, 60 EA/Case

Part Number 28882 3M Product Number 6004 3M ID 7000001937

Typical properties

Accessories

Yes

Brands

3M™

Cartridge or Filter Type

Combination

Case Quantity

60/carton

Clip-on Welding Shield

Yes

Compatible Respirator

3M™ Full Facepieces 6000, 3M™ Full Facepieces 7800 Series, 3M™ Full Facepieces FF-400, 3M™ Half Facepiece R

Dimensions and Classifications

Overall Height (Imperial)

3.4 in

Overall Height (Metric)

8.63 cm

Overall Length (Imperial)

4.2 in

Overall Length (Metric)

10.67 cm

3M™ Formaldehyde/Organic Vapor Cartridge 6005, 60 EA/Case

3M Product Number 6005 3M ID 7000001936 UPC 50051138288834

Typical properties

Accessories

Yes

Brands

3M™

Cartridge or Filter Type

Gas & Vapor

Case Quantity

2/pack

Clip-on Welding Shield

Yes

Compatible Respirator

3M™ Full Facepieces 6000, 3M™ Full Facepieces 7800 Series, 3M™ Full Facepieces FF-400, 3M™ Half Facepiece Reus

Dimensions and Classifications

Overall Height (Imperial)

3.4 in

Overall Length (Imperial)

4.2 in

3M™ Organic Vapor/Acid Gas Cartridge 6003/07047(AAD), 60 EA/Case

Part Number 07047 3M Product Number 6003 3M ID 7000051849

Typical properties

Accessories

Yes

Brands

3M™

Cartridge or Filter Type

Gas & Vapor

Case Quantity

60/case

Clip-on Welding Shield

Yes

Compatible Respirator

3M™ Full Facepieces 6000, 3M™ Full Facepieces 7800 Series, 3M™ Full Facepieces FF-400, 3M™ Half Facepiece Reu

Dimensions and Classifications

Overall Height (Imperial)

3.4 in

Overall Length (Imperial)

4.2 in

3M™ Acid Gas Cartridge 6002, 60 EA/Case

3M Product Number 6002 3M ID 7000051850 UPC 50051138288803

Typical properties

Accessories

Yes

Brands

3M™

Cartridge or Filter Type

Gas & Vapor

Case Quantity

60/case

Clip-on Welding Shield

Yes

Compatible Respirator

3M™ Full Facepieces 6000, 3M™ Full Facepieces 7800 Series, 3M™ Full Facepieces FF-400, 3M™ Half Facepiece Reu

Dimensions and Classifications

Overall Height (Imperial)

3.4 in

Overall Height (Metric)

8.63 cm

Overall Length (Imperial)

4.2 in

Overall Length (Metric)

10.67 cm

3M™ Organic Vapor Cartridge 6001, 60 EA/Case

Part Number 21674 3M Product Number 6001 3M ID 7000051851

Typical properties

Accessories

Yes

Brands

3M™

Cartridge or Filter Type

Gas & Vapor

Case Quantity

60/case

Clip-on Welding Shield

Yes

Compatible Respirator

3M™ Full Facepieces 6000, 3M™ Full Facepieces 7800 Series, 3M™ Full Facepieces FF-400, 3M™ Half Facepiece Reu

Dimensions and Classifications

Overall Height (Imperial)

3.4 in

Overall Length (Imperial)

4.2 in

3M™ DBI-SALA® Adjustable Web Positioning Lanyard 1231011, 3 ft

Part Number 1231011 3M Product Number 1231011 3M ID 7100247152

Details

The web, rope and chain positioning lanyards are available in a variety of lengths
User friendly self locking snap hooks at each end
Equipped with 3M™ Connected Safety ID (CSID)
User friendly self locking snap hooks at each end
Equipped with 3M™ Connected Safety ID (CSID)
Equipped with 3M™ Connected Safety ID (CSID)

Typical properties

Anchor Connection Type
Snap Hook
Anchor Hook Material
Zinc Plated Steel
Brands
DBI-SALA®
Case Quantity
1
Connected Safety ID Equipped
Yes
Energy Absorber Class
None
Harness Connection Hook Material
Zinc Plated Steel
Harness Connection Type

Dimensions and Classifications

Overall Length (Imperial)
3 ft

3M™ DBI-SALA® Adjustable Web Positioning Lanyard 1231013, 5 ft

Part Number 1231013 3M Product Number 1231013 3M ID 7012817000

Details

The web, rope and chain positioning lanyards are available in a variety of lengths
User friendly self locking snap hooks at each end
Equipped with 3M™ Connected Safety ID (CSID)
User friendly self locking snap hooks at each end
Equipped with 3M™ Connected Safety ID (CSID)
Equipped with 3M™ Connected Safety ID (CSID)

Typical properties

Anchor Connection Type
Snap Hook
Anchor Hook Material
Zinc Plated Steel
Brands
DBI-SALA®
Case Quantity
1
Connected Safety ID Equipped
Yes
Energy Absorber Class
None
Harness Connection Hook Material
Zinc Plated Steel
Harness Connection Type

Dimensions and Classifications

Overall Length (Imperial)
5 ft

3M™ DBI-SALA® Adjustable Rope Positioning Lanyard 1232209, 1/2 in Nylon, 6 ft

Part Number 1232209 3M Product Number 1232209 3M ID 7012817067

Details

The web, rope and chain positioning lanyards are available in a variety of lengths
User friendly self locking snap hooks at each end
Equipped with 3M™ Connected Safety ID (CSID)
User friendly self locking snap hooks at each end
Equipped with 3M™ Connected Safety ID (CSID)
Equipped with 3M™ Connected Safety ID (CSID)

Typical properties

Anchor Connection Type
Snap Hook
Anchor Hook Material
Zinc Plated Steel
Brands
DBI-SALA®
Case Quantity
1
Connected Safety ID Equipped
Yes
Energy Absorber Class
None
Harness Connection Hook Material
Zinc Plated Steel
Harness Connection Type

Dimensions and Classifications

Overall Length (Imperial)
6 ft

3M™ DBI-SALA® Adjustable Web Positioning Lanyard 1231022, 8 ft

Part Number 1231022 3M Product Number 1231022 3M ID 7100241702

Details

The web, rope and chain positioning lanyards are available in a variety of lengths
User friendly self locking snap hooks at each end
Equipped with 3M™ Connected Safety ID (CSID)
User friendly self locking snap hooks at each end
Equipped with 3M™ Connected Safety ID (CSID)
Equipped with 3M™ Connected Safety ID (CSID)

Typical properties

Anchor Connection Type
Snap Hook
Anchor Hook Material
Zinc Plated Steel
Brands
DBI-SALA®
Case Quantity
1
Connected Safety ID Equipped
Yes
Energy Absorber Class
None
Harness Connection Hook Material
Zinc Plated Steel
Harness Connection Type

Dimensions and Classifications

Overall Length (Imperial)
8 ft

3M™ PELTOR™ Hygiene Kit for Earmuffs HYX4/37283(AAD), Hearing Conservation, 10 Kits/Case

3M Product Number HYX4 3M ID 7000104048 UPC 04046719723591

Details

Easily snaps into employee's own earmuffs enabling fit test. Adapter clips hold microphone next to earmuff for proper positioning during testing
Probed cushions can be cleaned with hygiene wipes and reused
Adapter clips hold microphones next to earmuffs during testing
*The NRR may overestimate the hearing protection provided during typical use

Typical properties

Brands
PELTOR™
Case Quantity
10
Compatible Earmuff
X4-A, X4-P3E, X4-P51E, X4-P5E
Cord Type
None
Electrically Insulated
Yes
Hearing Protection Style
Hygiene Kit
Product Color
Black
Product Series
HYX4, X Series
Product Type
Hygiene Kit
Re

3M™ PELTOR™ Hygiene Kit for Earmuffs HYX5/37284(AAD), Hearing Conservation, 10 Kits/Case

3M Product Number HYX5 3M ID 7000104049 UPC 04046719723645

Details

Easily snaps into employee's own earmuffs enabling fit test. Adapter clips hold microphone next to earmuff for proper positioning during testing
Probed cushions can be cleaned with hygiene wipes and reused
Adapter clips hold microphones next to earmuffs during testing
*The NRR may overestimate the hearing protection provided during typical use

Typical properties

Brands
PELTOR™
Case Quantity
10
Compatible Earmuff
X5-A, X5-P3E, X5-P5E
Cord Type
None
Electrically Insulated
Yes
Hearing Protection Style
Hygiene Kit
Product Color
Black
Product Series
HYX5, X Series
Product Type
Hygiene Kit
Recommended

3M™ Versaflo™ Easy Clean Backpack TR-927, 1 Ea/Case

3M Product Number TR-927 3M ID 7100300071

Details

Designed with a smooth surface to be easily cleanable

Versatile adjustability for comfortable and stable fit

The smooth surface may help save time cleaning

Washable in a solution of soap and water

Designed to minimize contact with the back to help with ventilation

Comfortable and designed to be perceived as balanced when carried

Compatible with TR-300+, TR-600 and TR-800 PAPRs

Fits a variety of body sizes

When used with the TR-300+ PAPR system is IP53 rated and when used with the TR-600/800 PAPRs it is IP54 rated

Securely holds TR-300+, TR-600 and TR-800 PAPRs

Typical properties

Brands

Versaflo™

Case Quantity

1

Compatible Respirator Type

PAPR

Compatible With

3M™ Versaflo™ TR-300+ Series PAPR, 3M™ Versaflo™ TR-600 Series PAPR,

3M™ Versaflo™ TR-800 Series PAPR

Maintenance Free

Yes

Mounting Type

Back-Mounted

Product Color

3M™ Half Facepiece Disposable Respirator Assembly 52P71, Organic Vapor/P95 Respiratory Protection, Medium 12 EA/Case

Part Number 66069 3M Product Number 52P71 3M ID 7000052080

Details

NIOSH-approved against certain organic vapors (black label)
Recommended for use in a variety of workplace applications, including petrochemical, chemical manufacturing, construction, transportation, electronics, and more

This respiratory protection system is not for use in environments that are immediately dangerous to life or health (IDLH)

This respirator can be worn with additional personal protective equipment (PPE)
For workplace/occupational use only

Typical properties

Accessories

No

Adjustable Buckle Straps

Yes

Assigned Protection Factor

10

Brands

3M™

Cartridge or Filter Included

Yes

Case Quantity

12/case

Clip-on Welding Shield

No

Compatible with 3M™ PAPR Systems

No

Compatible with 3M™ Supplied Air Syst

3M™ Speedglas™ G5-01 Outer Flip-Up Welding Shield w Hinge Mech, Pivot Ring, and Outer Welding Visor Frame, 46-0099-34, 1 EA/Case

3M Product Number 46-0099-34 3M ID 7100214378 UPC 00076308944650

Details

For maximum safety and comfort, make it a habit to check your equipment regularly
Replace worn out or damaged parts

Typical properties

Brands
Speedglas™
Compatible Welding Helmet
G5-01 Welding Helmets
Product Color
Black
Product Series
G5
Recommended Application
Grinding, Metal Processing, Metal Repair, Welding
Recommended Industry
General Manufacturing, Heavy Infrastructure,

3M™ Multi Gas/Vapor Cartridge/Filter 60926, P100 60 EA/Case

Part Number 54187 3M Product Number 60926 3M ID 7000002041

Typical properties

Accessories

Yes

Aerosol Type

Oil and Non-Oil

Brands

3M™

Cartridge or Filter Type

Gas & Vapor

Case Quantity

1/pack

Clip-on Welding Shield

Yes

Compatible Respirator

3M™ Full Facepieces 6000, 3M™ Full Facepieces FF-400, 3M™ Half Facepiece Respir

Dimensions and Classifications

Overall Height (Imperial)

3.4 in

Overall Length (Imperial)

4.2 in

3M™ Ammonia/ Methylamine/Filter 60924, P100, 60 EA/Case

3M Product Number 60924 3M ID 7000051992 UPC 50051138464689

Details

CE approved to protect against a range of gases, vapours and particulates depending on the model selected
Bayonet-style connection fits a wide range of compatible half and full facepiece 3M™ Reusable Respirators
Use with CE approved 3M™ 6000 Series Half Face Masks, 6500QL Series, 7500 Series and 6000 Series Full Face Masks
Swept-back, low profile design for optimised field of view and balance

Typical properties

Accessories
Yes
Aerosol Type
Oil and Non-Oil
Brands
3M™
Cartridge or Filter Type
Combination
Case Quantity
60/case
Clip-on Welding Shield
Yes
Compatible Respirator
3M™ Full Facepieces 6000, 3M™ Full Facepieces 7800 Series, 3M™ Full Facepieces

Dimensions and Classifications

Overall Height (Imperial)
3.4 in
Overall Length (Imperial)
4.2 in

3M™ Organic Vapor Cartridge/Filter 60921, P100 60 EA/Case

Part Number 60921 3M Product Number 60921 3M ID 7000029639

Typical properties

Accessories

Yes

Aerosol Type

Oil and Non-Oil

Brands

3M™

Cartridge or Filter Type

Gas & Vapor

Case Quantity

60/case

Clip-on Welding Shield

Yes

Compatible Respirator

3M™ Full Facepieces 6000, 3M™ Full Facepieces 7800 Series, 3M™ Full Facepieces

Dimensions and Classifications

Overall Height (Imperial)

3.4 in

Overall Length (Imperial)

4.2 in

3M™ Organic Vapor/Acid Gas Cartridge/Filter 60923, P100, 60 EA/Case

3M Product Number 60923 3M ID 7000029640 UPC 50051138464672

Typical properties

Accessories

Yes

Aerosol Type

Oil and Non-Oil

Brands

3M™

Cartridge or Filter Type

Gas & Vapor

Case Quantity

60/case

Clip-on Welding Shield

Yes

Compatible Respirator

3M™ Full Facepieces 6000, 3M™ Full Facepieces 7800 Series, 3M™ Full Facepieces

Dimensions and Classifications

Overall Height (Imperial)

3.4 in

Overall Length (Imperial)

4.2 in

3M™ Organic Vapor/Acid Gas Cartridge/Filter 60928, P100 60 EA/Case

3M Product Number 60928 3M ID 7000002009 UPC 50051138464702

Typical properties

Accessories

Yes

Brands

3M™

Cartridge or Filter Type

Gas & Vapor

Case Quantity

60/case

Clip-on Welding Shield

Yes

Compatible Respirator

3M™ Full Facepieces 6000, 3M™ Full Facepieces 7800 Series, 3M™ Full Facepieces FF-400, 3M™ Half Facepiece Reu

Dimensions and Classifications

Overall Height (Imperial)

3.4 in

Overall Height (Metric)

8.63 cm

Overall Length (Imperial)

4.2 in

Overall Length (Metric)

10.67 cm

3M™ DBI-SALA® Detent Anchor Socket and Cap For Concrete 2101000, Fits 7/8 in Hole

Part Number 2101000 3M Product Number 2101000 3M ID 7012818267

Details

Rugged and corrosion resistant material construction for durability with compact and lightweight design
Use vertically in wall or horizontally in ceiling (both components)
High strength steel construction
Compatible with various fall arrest systems
Meets the requirements for 29 CFR OSHA 1910.140, and OSHA 1926.502
Recommended for use in the construction, general industrial, mining, oil and gas, and utilities industries
This safety equipment is designed for use with additional personal fall protection systems (PPE)
Installs into 7/8 in. (22 mm) concrete hole with adhesive
Socket cover cap included
Reusable detent D-ring assembly - extra sockets (#2101000) and detent D-rings (#2101002) also available

Typical properties

Anchor Install Type
Permanent
Attachment Type
Screw/Adhesive
Brands
DBI-SALA®
Case Quantity
1
Connected Safety ID Equipped
No
Install Type
Reusable or Permanent
Material
Stainless Steel
Product Color
Silver
Product Type
Concrete Detent So

3M™ DBI-SALA® Perimeter Limiter Leading Edge Anchor 2100090

Part Number 2100090 3M Product Number 2100090 3M ID 7100227987

Details

Freestanding design to minimize any impact to the installation surface
Counterweight design is fast and easy to install for up to two users while the tall mast reduces fall clearances
Large foam filled flat-free tires make it easy to move from one job to the next
Tie-off points are built into the system for personal fall arrest systems
This safety equipment is designed for use with additional personal protective equipment
Conforms to the requirements of 29 CFR OSHA 1926.502 and OSHA 1910.140
Compatible with various fall arrest systems
Recommended for use in the construction, general industrial, mining, and oil and gas industries
Rotating mast / arm for complete mobility
Integrated anchor point and pulley for rescue system

Typical properties

Anchor Install Type
Reusable
Attachment Type
Counterweight
Brands
DBI-SALA®
Case Quantity
1
Connected Safety ID Equipped
No
Dimensions
188.00x74.00x100.00in
Install Type
Reusable
Material
Steel
Product Type
Perimeter Limiter Leading Edge

3M™ DBI-SALA® D-ring Attachment 0.5" x 2.25" 1500004, 100 EA/PACK

3M Product Number 1500004 3M ID 7100214251 UPC 00852684930612

Details

Compatible with 3M™ DBI-SALA® Fall Protection for Tools accessories
Provides workers an attachment point to secure tools and accessories while working at height
Multiple attachment point and capacity options designed for a variety of applications

Typical properties

Brands
DBI-SALA®
Case Quantity
100
Connected Safety ID Equipped
No
Dimensions
0.50 x 2.25 inch
Net Weight (Imperial)
0.3 lb
Net Weight (Metric)
0.1 kg
Product Type
D-ring Attachment 0.5 in x 2.25 in
Recommended Industry
Construction, Genera

3M™ DBI-SALA® Nano-Lok™ Connected Order Picker Self-Retracting Lifeline 2000044, Hook Electronics, Web, 6 ft

3M Product Number 2000044 3M ID 7012818207

Details

SRL that pairs with visual and audible alert system designed to inform worker and surrounding area when an operator is not tied off
Dual sensing hook that detects if the hook gate is fully closed and locked
Works with all metallic OSHA rated dorsal D-Ring's
Lightweight aluminum snap hook with plastic cover
Dynema™ fiber and polyester web lifeline
Swiveling anchorage loop
Self-retracting lifeline only

Typical properties

Anchor Connection Type
Cab-mount Bracket
Anchor Hook Material
Stainless Steel
Attachment Type
Bolt and Clamp-On
Brands
DBI-SALA®
Carabiner/Hook Material
Aluminum
Connected Safety ID Equipped
Yes
Harness Connection Type
Connected Carabiner
Ho

3M™ Speedglas™ 9100 Hard Hat Adapter 06-0014-00NR, for 3M™ Speedglas™ Welding Helmets, No Hard Hat

3M Product Number 06-0014-00NR 3M ID 7100291855 UPC 00638060434772

Details

Adjustable adaptor attaches 3M™ Speedglas™ Welding Helmet 9100 to most hard hats

All mounting hardware included

Allows for easy integration of headcover for welding

One adapter per case

Applications include assembly, facility maintenance, grinding, machine operations, sanding, and welding

For use in the construction, heavy infrastructure, and industrial maintenance industries

Typical properties

Brands

Speedglas™

Case Quantity

1

Compatible Welding Helmet

9100 Series

Features

Head Protection

Headgear Type

Hard Hats

Product Color

Black

Product Type

Hard Hat Adapter

Recommended Application

Assembly, Facility Maintenance, Grinding, Mac

3M™ Secure Click™ Lens Replacement FF-800-01, 5 ea/Case

Part Number FF-800-01 3M Product Number FF-800-01 3M ID 7100263777

Details

Scotchgard™ Protector on lens for improved paint and stain resistance
Replaceable part can potentially result in respiratory equipment cost savings

Typical properties

Accessories

Yes

Brands

Secure Click™

Case Quantity

5

Compatible Respirator

FF-800 Series, Secure Click™ HF-800 Series Full Facepiece Reusable
Respirators

Compatible with 3M™ PAPR Systems

No

Compatible with 3M™ Supplied Air System

No

Enhanced C

Dimensions and Classifications

Overall Height (Imperial)

3.365 in

Overall Height (Metric)

85.483 mm

Overall Length (Imperial)

8.53 in

Overall Length (Metric)

216.653 mm

Overall Width (Imperial)

7.127 in

Overall Width (Metric)

181.017 mm

По вопросам продаж и поддержки обращайтесь:

Алматы (7273)495-231
Ангарск (3955)60-70-56
Архангельск (8182)63-90-72
Астрахань (8512)99-46-04
Барнаул (3852)73-04-60
Белгород (4722)40-23-64
Благовещенск (4162)22-76-07
Брянск (4832)59-03-52
Владивосток (423)249-28-31
Владикавказ (8672)28-90-48
Владимир (4922)49-43-18
Волгоград (844)278-03-48
Вологда (8172)26-41-59
Воронеж (473)204-51-73
Екатеринбург (343)384-55-89

Иваново (4932)77-34-06
Ижевск (3412)26-03-58
Иркутск (395)279-98-46
Казань (843)206-01-48
Калининград (4012)72-03-81
Калуга (4842)92-23-67
Кемерово (3842)65-04-62
Киров (8332)68-02-04
Коломна (4966)23-41-49
Кострома (4942)77-07-48
Краснодар (861)203-40-90
Красноярск (391)204-63-61
Курск (4712)77-13-04
Курган (3522)50-90-47
Липецк (4742)52-20-81

Магнитогорск (3519)55-03-13
Москва (495)268-04-70
Мурманск (8152)59-64-93
Набережные Челны (8552)20-53-41
Нижегород (831)429-08-12
Новокузнецк (3843)20-46-81
Ноябрьск (3496)41-32-12
Новосибирск (383)227-86-73
Омск (3812)21-46-40
Орел (4862)44-53-42
Оренбург (3532)37-68-04
Пенза (8412)22-31-16
Петрозаводск (8142)55-98-37
Псков (8112)59-10-37
Пермь (342)205-81-47

Ростов-на-Дону (863)308-18-15
Рязань (4912)46-61-64
Самара (846)206-03-16
Санкт-Петербург (812)309-46-40
Саратов (845)249-38-78
Севастополь (8692)22-31-93
Саранск (8342)22-96-24
Симферополь (3652)67-13-56
Смоленск (4812)29-41-54
Сочи (862)225-72-31
Ставрополь (8652)20-65-13
Сургут (3462)77-98-35
Сыктывкар (8212)25-95-17
Тамбов (4752)50-40-97
Тверь (4822)63-31-35

Тольятти (8482)63-91-07
Томск (3822)98-41-53
Тула (4872)33-79-87
Тюмень (3452)66-21-18
Ульяновск (8422)24-23-59
Улан-Удэ (3012)59-97-51
Уфа (347)229-48-12
Хабаровск (4212)92-98-04
Чебоксары (8352)28-53-07
Челябинск (351)202-03-61
Череповец (8202)49-02-64
Чита (3022)38-34-83
Якутск (4112)23-90-97
Ярославль (4852)69-52-93

Россия +7(495)268-04-70

Казахстан +7(7172)727-132

Киргизия +996(312)96-26-47

эл.почта: tam@nt-rt.ru || сайт: <https://3m.nt-rt.ru/>