

еди инские принадлежности

Технические характеристики

По вопросам продаж и поддержки обращайтесь:

Алматы (7273)495-231
Ангарск (3955)60-70-56
Архангельск (8182)63-90-72
Астрахань (8512)99-46-04
Барнаул (3852)73-04-60
Белгород (4722)40-23-64
Благовещенск (4162)22-76-07
Брянск (4832)59-03-52
Владивосток (423)249-28-31
Владикавказ (8672)28-90-48
Владимир (4922)49-43-18
Волгоград (844)278-03-48
Вологда (8172)26-41-59
Воронеж (473)204-51-73
Екатеринбург (343)384-55-89

Иваново (4932)77-34-06
Ижевск (3412)26-03-58
Иркутск (395)279-98-46
Казань (843)206-01-48
Калининград (4012)72-03-81
Калуга (4842)92-23-67
Кемерово (3842)65-04-62
Киров (8332)68-02-04
Коломна (4966)23-41-49
Кострома (4942)77-07-48
Краснодар (861)203-40-90
Красноярск (391)204-63-61
Курск (4712)77-13-04
Курган (3522)50-90-47
Липецк (4742)52-20-81

Магнитогорск (3519)55-03-13
Москва (495)268-04-70
Мурманск (8152)59-64-93
Набережные Челны (8552)20-53-41
Нижегород (831)429-08-12
Новокузнецк (3843)20-46-81
Ноябрьск (3496)41-32-12
Новосибирск (383)227-86-73
Омск (3812)21-46-40
Орел (4862)44-53-42
Оренбург (3532)37-68-04
Пенза (8412)22-31-16
Петрозаводск (8142)55-98-37
Псков (8112)59-10-37
Пермь (342)205-81-47

Ростов-на-Дону (863)308-18-15
Рязань (4912)46-61-64
Самара (846)206-03-16
Санкт-Петербург (812)309-46-40
Саратов (845)249-38-78
Севастополь (8692)22-31-93
Саранск (8342)22-96-24
Симферополь (3652)67-13-56
Смоленск (4812)29-41-54
Сочи (862)225-72-31
Ставрополь (8652)20-65-13
Сургут (3462)77-98-35
Сыктывкар (8212)25-95-17
Тамбов (4752)50-40-97
Тверь (4822)63-31-35

Тольятти (8482)63-91-07
Томск (3822)98-41-53
Тула (4872)33-79-87
Тюмень (3452)66-21-18
Ульяновск (8422)24-23-59
Улан-Удэ (3012)59-97-51
Уфа (347)229-48-12
Хабаровск (4212)92-98-04
Чебоксары (8352)28-53-07
Челябинск (351)202-03-61
Череповец (8202)49-02-64
Чита (3022)38-34-83
Якутск (4112)23-90-97
Ярославль (4852)69-52-93

Россия +7(495)268-04-70

Казахстан +7(7172)727-132

Киргизия +996(312)96-26-47

эл.почта: tam@nt-rt.ru || сайт: <https://3m.nt-rt.ru/>



3M™ Scotchpak™ Polyester Backing Film Laminate, 9738, Config Roll

3M Stock
7100065993
Previous 3M Stock
70000202286



3M™ Attest™ Rapid Steam Biological Indicator, 1292, Brown Cap, 3 hr, 50/CAR, 4 CAR/CS, 200/CS

3M Stock
7000002632
Previous 3M Stock
70200620527
UPC
30707387236442



3M™ Attest™ Rapid Steam Biological Indicator, 1291, Blue Cap, 1 hr, 50/CAR, 4 CAR/CS, 200/CS

3M Stock
7000002621
Previous 3M Stock
70200586413
UPC
30707387140930



3M™ Attest™ Rapid Steam Biological Indicator Test Pack, 1296, Brown Cap, 3 hr, 25/CS

3M Stock
7000002696
Previous 3M Stock
70200690868
UPC
50707387236453



3M™ Attest™ Rapid Ethylene Oxide Biological Indicator Test Pack, 1298, Green Cap, 4 hr, 25/CAR, 2 CAR/CS, 50/CS

3M Stock
7000002716
Previous 3M Stock
70200704610
UPC
30707387470396



3M™ Attest™ Ethylene Oxide Biological Indicator, 1264, Green Cap, 48 hr, 100/PAC, 4 PAC/CS, 400/CS

3M Stock
7000002546
Previous 3M Stock
70200536962
UPC
30707387068050



3M™ Microfluidic Diagnostic Tape, 9982R, Silicone Adhesive on Clear PET Tape, 0.98 mil, Configurable

3M Stock
7100244307
Previous 3M Stock
70000128267



3M™ Attest™ Rapid Ethylene Oxide Biological Indicator, 1294-S, Green Cap, 4 hr, 300/CAR, 2 CAR/CS, 600/CS

3M Stock
7000053808
Previous 3M Stock
70200750555
UPC
30707387575138



3M™ Prevena Restor™ Adapti-Form™ System Kit, PRE6001, 1 Kit

3M Stock
7100284253
Previous 3M Stock
70001446684
UPC
50849554012948



3M™ Steri-Drape™ Extremity Cover 9041 Non-sterile

3M Stock
7000053576
Previous 3M Stock
70200687690
UPC
50707387456226



3M™ Attest™ Rapid Steam Biological Indicator, 1292-S, Brown Cap, 3 hr, 300/CAR, 2 CAR/CS, 600/CS

3M Stock
7000053809
Previous 3M Stock
70200750563
UPC
30707387575145



3M™ Attest™ Ethylene Oxide Biological Indicator, 1264-S, Green Cap, 48 hr, 300/CAR, 2 CAR/CS, 600/CS

3M Stock
7000053810
Previous 3M Stock
70200750571
UPC
30707387575152



3M™ Medical Tape 9877, Double Sided Transparent Polyester, 60# Liner, Configurable

3M Stock
7100000160
Previous 3M Stock
70000063696



3M™ Avagard™ Drip Tray Accessory 9243, 12 EA/Case

3M Stock
7100032641
Previous 3M Stock
70200765728
UPC
50707387764994



3M™ Ranger™ Pressure Infusor, 14500, Model 145, 120V-ENG-B, 1 Each

3M Stock
7100236176
Previous 3M Stock
70201801886
UPC
00707387802943



3M™ Double Stick Discs, 102 each/pack, 6 pack/case, 2181

3M Stock
7000053508
Previous 3M Stock
70200618570
UPC
50707387234800



3M™ Medical Loop Fastener 7331, Low Profile with Adhesive, Configurable

3M Stock
7100070639
Previous 3M Stock
70000126931

3M™ Steri-Strip™ Compound Benzoin Tincture C1544, 2/3 cc vial, 40 Packs/Carton, 4 Cartons/Case

3M Stock
7100239556
Previous 3M Stock
70201189357
UPC
10707387792814



3M™ Medical Tape 9833, Single Sided Polyurethane, 78# Carrier, Configurable

3M Stock
7100000231
Previous 3M Stock
70000127129



3M™ Medical Tape 1776, Single Sided Polyester Spunlace Nonwoven Fabric, 83# Liner, Configurable

3M Stock
7100013450
Previous 3M Stock
70000028376



3M™ Medical Tape 1525L, Single Sided Transparent Polyethylene, 63# Liner, Configurable

3M Stock
7100001452
Previous 3M Stock
70000008105



3M™ Medical Tape 9904, Single Sided High Tack Elastic Nonwoven Fabric, 60# Liner, Configurable

3M Stock
7100045884
Previous 3M Stock
70000126915



3M™ Medical Release Liner 1360, Silicone, 63 # Paper, 49.5 IN x 7,000 YD

3M Stock
7100116033
Previous 3M Stock
70200736380
UPC
00707387559434



3M™ Steri-Drape™ Cardiovascular Sheet with Ioban™ 2 Incise Film, 2040NS, 38 cm x 41cm, 200/Case

3M Stock
7000053489
Previous 3M Stock
70200559212
UPC
00707387098575



**3M™ Steri-Drape™
Cardiovascular Sheet with
Ioban™ 2 Incise Film, 2045NS,
60 cm x 45 cm, 200/Case**

3M Stock
7000053490

Previous 3M Stock
70200559220

UPC
00707387098582

**3M™ Steri-Drape™ 2 Incise
Drape, 2045, Incise Area 50 cm
x 45 cm (19 5/8 in x 17 5/8 in),
10/Case, 4 Cartons/Case**

3M Stock
7100238519

Previous 3M Stock
70201800276

UPC
50707387793062

Alternative ID
2045

**3M™ Steri-Drape™ 2 Incise
Drape, 2051, Incise Area 60 cm
x 85 cm (23 1/2 in x 33 3/8 in),
10/Case, 4 Cartons/Case**

3M Stock
7100238517

Previous 3M Stock
70201800292

UPC
50707387793086

**3M™ Steri-Drape™ (1030)
31" (80cm)**

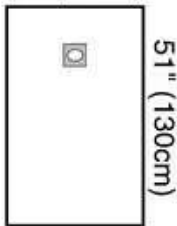

**3M™ Steri-Drape™ Medium
Drape with Aperture, 1030, 130
cm x 80 cm (51 in x 31 in),
10/Case, 4 Cartons/Case**

3M Stock
7000053456

Previous 3M Stock
70200533662

UPC
30707387018765

Alternative ID
1030

**3M™ Medical Tape 1567,
Double Sided Polyester, 60#
Liner, Configurable**

3M Stock
7100287656

Previous 3M Stock
70000128408

Alternative ID
1567

**3M™ Medical Tape 9877EL,
Double Coated Transparent
Polyester, 80# Liner,
Configurable**

3M Stock
7100127436

Previous 3M Stock
7000064355



3M™ Ranger™ Fluid Warming Irrigation Set, 24750, 10/Case

3M Stock
7100235070
Previous 3M Stock
70200793589
UPC
10707387792722



3M™ Bair Hugger™ 700 Series Warming Unit Rolling Cart Handle, 90094, 1 Each

3M Stock
7100242338
Previous 3M Stock
70201802330
UPC
10707387806634

Cavilon No-Rinse Skin Cleanser 3380, 8 oz. Spray bottle

3M™ Cavilon™ No-Rinse Skin Cleanser 3380

3M Stock
7000009914
Previous 3M Stock
70200764424
UPC
50707387446968



3M™ Avagard™ Instant Hand Antiseptic Wall Bracket, 9236, (White), 16 Each/Case

3M Stock
7000053936
Previous 3M Stock
70200762113
UPC
50707387584677



3M™ Surgical Clipper Professional Blade, 9680, 50 EA/Case

3M Stock
7100213055
Previous 3M Stock
70201185074
UPC
50707387789454



3M™ Medical Transfer Adhesive 4075, Extended Wear, Poly Liner, CONFIGURABLE

3M Stock
7100167252
Previous 3M Stock
70000128085
Alternative ID
4075



3M™ Electrosurgical Reusable Cable 21174L

3M Stock
7000128567
Previous 3M Stock
70200701962
UPC
00707387468101



3M™ Coban™ 2 Lite Two-Layer Compression System with Stocking 2794N, 1 Kit/Case 8 Carton/Case

3M Stock
7100069004
Previous 3M Stock
70200789298
UPC
50707387773743



3M™ Medical Tape 4076, Polyester Spunlace Nonwoven Extended Wear, 83# Liner, CONFIGURABLE

3M Stock
7100145200
Previous 3M Stock
70000128051
Alternative ID
4076



3M™ CuroS™ Disinfecting Cap for Tego® Hemodialysis Connectors CTG1-270

3M Stock
7100085564
Previous 3M Stock
70200790171
UPC
50707387773811



3M™ Single-Patient Stethoscope, 100/cs, SPS-YA1100

3M Stock
7100137930
Previous 3M Stock
70201175083
UPC
50707387784206
Alternative ID
SPS-YA1100



3M™ Medical Tape 1587, Double Sided Differential Adhesive Polyester, 60# Liner, Configurable

3M Stock
7100013655
Previous 3M Stock
70000127483



**3M™ Medical Tape 9865A,
Single Sided Polyethylene, 42#
Liner, Configurable**

3M Stock
7100092058
Previous 3M Stock
70000126766



**3M™ Medical Tape 1527ENP,
Single Sided Transparent EVA
Embossed, 63# Liner,
Configurable**

3M Stock
7100082765
Previous 3M Stock
70000126402



**3M™ CoTran™ Pigmented
Polyethylene Monolayer Backing
Film, 9718, Configurable**

3M Stock
7100065959
Previous 3M Stock
70000200421



**3M™ Scotch Series 1100
Electrosurgical Patient Pad II,
1182, Split Non-Corded, 1
Each/Pack, 100 Packs/Case**

3M Stock
7100239282
Previous 3M Stock
70201802280
UPC
50707387804959



**3M™ Surgical Clipper
Professional, 9681, 1/CV**

3M Stock
7100213188
Previous 3M Stock
70201186155
UPC
00707387790530



**3M™ Littmann® Stethoscope
Spare Parts Kit Classic II
Pediatric Diaphragm Assembly,
40012, 10 Kit/Case**

3M Stock
7100060435
Previous 3M Stock
70200788340
UPC
00707387772994



3M™ Microfluidic Diagnostic Tape, 9981, Silicone Adhesive on Bright Aluminum Foil Tape, 11 in, 2 mil, Configurable

3M Stock
7100271523
Previous 3M Stock
70000128309



INFOV.A.C.™ Canister without Gel, M8275071/5, 5/pk

3M Stock
7100236776
Previous 3M Stock
70001413569
UPC
00849554002081



3M™ Bair Hugger™ Warming Blanket, 45534 NOVAPLUS Pediatric Underbody, 10/Case

3M Stock
7100087638
Previous 3M Stock
70200791286
UPC
50707387775204



3M™ Prevena Restor™ Adapti-Form™ Dressing, PRE6055, 5/CS

3M Stock
7100284255
Previous 3M Stock
70001721854
UPC
50849554012955



3M™ Microfluidic Diagnostic Tape, 9980, Single Coated Aluminum Tape, 11 IN, 4 mil, Configurable

3M Stock
7100271524
Previous 3M Stock
70000128291



3M™ Microfluidic Diagnostic Tape 9795T, Silicone Adhesive on Clear PET Tape, 7 mil, Configurable

3M Stock
7100241048
Previous 3M Stock
70000128200



3M™ Microfluidic Diagnostic Tape, 9981, Silicone Adhesive on Bright Aluminum Foil Tape, 11 in, 2 mil, Configurable

3M Stock
7100271523
Previous 3M Stock
70000128309



V.A.C.VIA™ GRANUFOAM™ Spiral Dressing, VIAGFM05, Medium, 5/pk

3M Stock
7100237040
Previous 3M Stock
70001422297
UPC
00849554003767



PREVENA PLUS DUO™ with PEEL & PLACE™ Dressing, PRE3021US, 20 cm/20 cm, 1/ea

3M Stock
7100237240
Previous 3M Stock
70001417602



3M™ Medical Hook Fastener 7335, Low Profile with Adhesive, CONFIGURABLE

3M Stock
7100012654
Previous 3M Stock
70000127228



INFOV.A.C.™ Canister without Gel, M8275071/5, 5/pk

3M Stock
7100236776
Previous 3M Stock
70001413569
UPC
00849554002081



3M™ Bair Hugger™ Warming Blanket, 45534 NOVAPLUS Pediatric Underbody, 10/Case

3M Stock
7100087638
Previous 3M Stock
70200791286
UPC
5070738775204



**3M™ Attest™ Ethylene Oxide
Biological Indicator, 1264, Green
Cap, 48 hr, 100/PAC, 4 PAC/CS,
400/CS**

3M Stock
7000002546

Previous 3M Stock
70200536962

UPC
30707387068050

**3M™ Avagard™ Replacement
Foot Pump 9203A**

3M Stock
7100003254

Previous 3M Stock
70200748559

UPC
50707387568219

**3M™ Medical Tape 1527MS,
Single Sided Transparent EVA
Perforated, W/O Liner,
Configurable**

3M Stock
7100070585

Previous 3M Stock
70000039787



**3M™ Microfluidic Diagnostic
Tape 9792R, Single Sided
Aluminum Tape,
CONFIGURABLE**

3M Stock
7100000227

Previous 3M Stock
70000126329

**3M™ Medical Hook Fastener
7336, Low Profile with Adhesive,
CONFIGURABLE**

3M Stock
7100127458

Previous 3M Stock
70000127764

Alternative ID
7336

**3M™ Medical Tape 1503, Single
Sided Polyethylene, 63# Liner,
Configurable**

3M Stock
7100041398

Previous 3M Stock
70000127046



**3M™ Single-use Specialty
Clipper Blade Assembly, 9690,
20 Each/Case**

3M Stock
7100213026
Previous 3M Stock
70201184911
UPC
50707387789294



**3M™ Steri-Drape™ Abdominal-
Perineal Drapes 2065**

3M Stock
7000053699
Previous 3M Stock
70200737131
UPC
30707387381722



**3M™ Avagard™ Universal
Hands-Free Wall Dispenser
9240**

3M Stock
7100046533
Previous 3M Stock
70200762402
UPC
50707387584998



**3M Medical Materials 9835
Polyethylene Single Coated
Tape**

**3M™ Microfluidic Diagnostic
Tape 9964, Single Sided Clear
Tape, CONFIGURABLE**

3M Stock
7100091573
Previous 3M Stock
70000126808

**3M™ Medical Tape 9835, Single
Sided White Ethylene Vinyl
Acetate Polyethylene, 83# Liner,
CONFIGURABLE**

3M Stock
7100013850
Previous 3M Stock
7000039209



**3M™ Attest™ Rapid Steam
Biological Indicator, 1291, Blue
Cap, 1 hr, 50/CAR, 4 CAR/CS,
200/CS**

3M Stock
7000002621
Previous 3M Stock
70200586413
UPC
30707387140930



3M™ Medical Tape 1516, Single Sided Transparent Polyester without Liner, Configurable

3M Stock
7100009944
Previous 3M Stock
7000021892



3M™ Scotchpak™ Fluoropolymer Coated Release Liner, 9755, Config Roll

3M Stock
7100065994
Previous 3M Stock
70000203029



3M™ CoTran™ PVC Foam Tape, 9772L, Configurable

3M Stock
7100119874
Previous 3M Stock
70000039878



3M™ Bair Hugger™ Patient Adjustable Warming Unit, 87500, 120V-ENG-B, 1 Each

3M Stock
7100236132
Previous 3M Stock
70201801449
UPC
00707387803438



3M™ Bair Hugger™ Warming Blanket 45034, NOVAPLUS Large Pediatric Underbody, 10/Case

3M Stock
7100087639
Previous 3M Stock
70200791278
UPC
50707387775198



3M™ Avagard™ Nail Cleaners 9204, 150 EA/Box 6 Box/Case

3M Stock
7000002741
Previous 3M Stock
70200718602
UPC
50707387505511



3M™ Surgical Clipper Professional Drop-in Charger Stand with Cord 9682 for 9681, US/Japan Plug

3M Stock
7100219372
Previous 3M Stock
70201187153
UPC
00707387791445

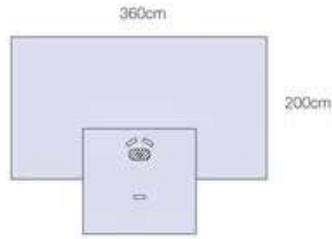

3M™ Steri-Drape™ Adhesive Split Sheet, 9052, 355 cm x 293 cm, 9/ Carton, 2/ Case

3M Stock
7100001382
Previous 3M Stock
70200738162
UPC
30707387561193



3M™ CoTran™ Polyethylene Foam Tape, 9773, Configurable

3M Stock
7100065955
Previous 3M Stock
70000039183



3M™ Electrosurgical Pad, 8180F, Large Split Non-Corded, 5 Each/Pack, 40 Packs/Case

3M Stock
7100238166
Previous 3M Stock
70201187724
UPC
50707387802917



3M™ Precise™ Staple Remover SR-3, 10/ Carton 3 Cartons/ Case

3M Stock
7000053510
Previous 3M Stock
70200624891
UPC
30707387027392



3M™ Microfluidic Diagnostic Tape 9972A, Double Sided Thick Spacer Tape, Configurable

3M Stock
7100277903
Previous 3M Stock
70000128333



3M™ Scotchpak™ Polyester Backing Film Laminate 9754, L250MMX150M,3F

3M Stock
7100119892
Previous 3M Stock
70000202971



3M™ Medical Tape 4077, Elastic Blend Nonwoven Extended Wear, 83# Liner, CONFIGURABLE

3M Stock
7100145201
Previous 3M Stock
70000128069
Alternative ID
4077



3M™ Bair Hugger™ 700 Series Warming Unit Hose Replacement With Sensor, 90046, 1 Each

3M Stock
7100242307
Previous 3M Stock
70200791807
UPC
00707387806613



3M™ Medical Tape 1526, Single Sided Polyethylene, 63# liner, Configurable

3M Stock
7100000880
Previous 3M Stock
70000005796



3M™ Medical Tape 1533L, Single Sided Microporous Rayon Nonwoven Fabric, 63# Liner, Configurable

3M Stock
7100000016
Previous 3M Stock
70000039498



3M™ Medical Foam Tape 9777L, Single Sided Polyvinyl Chloride, 72# liner, Configurable

3M Stock
7100000070
Previous 3M Stock
70000063548



3M™ Microfluidic Diagnostic Tape 9793R, Single Sided Clear Polyolefin Tape, CONFIGURABLE

3M Stock
7100000225
Previous 3M Stock
70000126295



3M™ Medical Release Liner 9956, Polyester, Fluoropolymer, Configurable

3M Stock
7100075835
Previous 3M Stock
70000127673



CORE Digital Attachment, 8481

3M Stock
7100235410
Previous 3M Stock
70201189431
UPC
00850010298009



3M™ Ranger™ Blood/Fluid Warming High Flow Set, 24355, 10/Case

3M Stock
7100235063
Previous 3M Stock
70200793258
UPC
00707387792688



3M™ 9984 Diagnostic Microfluidic Surfactant Free Fluid Transport Film, Configurable

3M Stock
7100070638
Previous 3M Stock
70000127798



3M™ Medical Tape 1510, Double Sided High Tack Conformable Polyethylene, 54# Liner, Configurable

3M Stock
7100012004
Previous 3M Stock
70000126790



**3M™ Medical Tape 9889,
Double Sided Transparent
Polyethylene, 60# Liner,
Configurable**

3M Stock
7100287658

Previous 3M Stock
70000128390

Alternative ID
9889A



**3M™ Surface Saver™ Plus
Optical RX Lens Processing
Tape, 1641, Medium Bond, 4 IN
X 50 YD/Roll 12RLS/CASE**

3M Stock
7100002606

Previous 3M Stock
70200739020

UPC
50707387561616



**3M™ Surface Saver™ Plus
Optical RX Lens Processing
Tape, 1640, High Bond, 4 IN X
50 YD/Roll 12RLS/CASE**

3M Stock
7100002607

Previous 3M Stock
70200739012

UPC
50707387561609



**3M™ Avagard™ Wall Bracket
and Hand Pump 9202**

3M Stock
7000002740

Previous 3M Stock
70200718586

UPC
00707387505493



**3M™ Medical Foam Tape 9781,
Single Sided Polyvinyl Chloride,
65# liner, Configurable**

3M Stock
7100000166

Previous 3M Stock
70000065352



**3M™ Surgical Clipper with
Pivoting Head, 9667L, 1/Case**

3M Stock
7100219367

Previous 3M Stock
70201187203

UPC
00707387791490



3M™ Medical Tape 1527LX, Single Sided Transparent Ethylene Vinyl Acetate Perforated, 83# Liner, Configurable

3M Stock
7100090413

Previous 3M Stock
70000127426



3M™ Medical Tape 1521, Single Sided Transparent Polyethylene, 83# Liner, Configurable

3M Stock
7100013875

Previous 3M Stock
70000005853



3M™ Medical Tape 9916, Single Sided Spunlaced Nonwoven Fabric, 62# Liner, Configurable

3M Stock
7100000229

Previous 3M Stock
70000126741



3M™ Microfluidic Diagnostic Film 9962, Thin Double Sided Hydrophilic Film, CONFIGURABLE

3M Stock
7100012434

Previous 3M Stock
70000127707



3M™ Medical Tape 9917, Double Sided Spunlaced Nonwoven Fabric, 62# Liner, Configurable

3M Stock
7100000230

Previous 3M Stock
70000126758



3M™ Medical Tape 1530, Single Sided Microporous Rayon Nonwoven Fabric, Without Liner, Configurable

3M Stock
7100009942

Previous 3M Stock
70000019680



3M™ Steam Log Book 1266

3M Stock
7000053695

Previous 3M Stock
70200736273

UPC
00707387044978

Alternative ID
1266

3M™ Medical Tape 1533, Single Sided Microporous Tan Rayon Nonwoven Fabric, W/O Liner, Configurable

3M Stock
7100003043

Previous 3M Stock
70000005788

3M™ Microfluidic Diagnostic Tape 9965, Double Sided White Tape, CONFIGURABLE

3M Stock
7100067080

Previous 3M Stock
70000126816



3M™ Surgical Clipper with Pivoting Head, 9661L, 1 Each/Case

3M Stock
7100213034

Previous 3M Stock
70201185348

UPC
00707387789725



3M™ Attest™ Rapid Steam Biological Indicator Test Pack, 1296, Brown Cap, 3 hr, 25/CS

3M Stock
7000002696

Previous 3M Stock
70200690868

UPC
50707387236453



3M™ Surgical Clipper with Pivoting Head, 9662L, 1/Case

3M Stock
7100219369

Previous 3M Stock
70201187179

UPC
00707387791469



3M™ Steri-Drape™ Bilateral Split Sheet 9046

3M Stock
7000053582

Previous 3M Stock
70200687799

UPC
50707387456325



3M™ Avagard™ Universal Manual Wall Dispenser 9241

3M Stock
7000053940

Previous 3M Stock
70200762410

UPC
50707387761856



3M™ Medical Film 9832F, Polyurethane on White 78# Carrier, CONFIGURABLE

3M Stock
7100102225

Previous 3M Stock
70000127145



3M™ Microfluidic Diagnostic Tape 9795R, Single Sided Clear Delayed Tack Adhesive Tape , CONFIGURABLE

3M Stock
7100224806

Previous 3M Stock
70000128135



3M™ Bair Hugger™ Temperature Monitoring Patient Sensor, 36000, 25/Case

3M Stock
7100236253

Previous 3M Stock
70201802082

UPC
50707387792959



3M™ Avagard™ Floor Stand, 9244, 1EA/CS

3M Stock
7000054136

Previous 3M Stock
70200771668

UPC
00707387766986



3M™ Steri-Drape™ (1021)

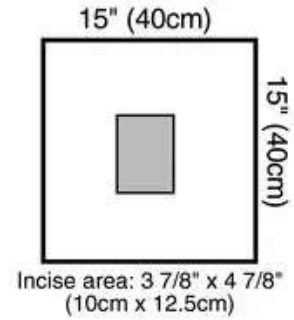

3M™ Surgical Clipper with Pivoting Head, 9660, 50/Case

3M Stock
7100213114

Previous 3M Stock
70201184622

UPC
50707387789003

3M™ Steri-Drape™ Gynecological Drape with Pouch 1080

3M Stock
7100002165

Previous 3M Stock
70200737115

UPC
30707387381777

3M™ Steri-Drape™ Small Drape with Incise Film, 1021, 40 cm x 40 cm (15 in x 15 in), 10/Case, 4 Cartons/Case

3M Stock
7000053444

Previous 3M Stock
70200520305

UPC
30707387058204

Alternative ID
1021

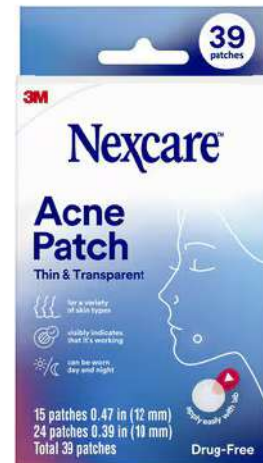

Nexcare™ Acne Cover AC-036

3M Stock
70005149250

UPC
00051131208995

Nexcare™ Acne Cover AC-108

3M Stock
70007026951

UPC
00051131216709

Nexcare™ Thin and Transparent Acne Patch BA-039, 1x15x12mm+1x24x10mm, 30 Pack/Case

3M Stock
UU012177844

UPC
04710367732624



**Nexcare™ Thin and Transparent
Acne Patch BA-117,
3x15x12mm+3x24x10mm, 30
Pack/Case**

3M Stock
UU012177869
UPC
04710367732648



**3M™ Steri-Vac™
Sterilizer/Aerator, GSX Series**



**3M™ Medipore™ +Pad Soft
Cloth Adhesive Wound
Dressing, 3500 Series**



**3M™ Attest™ Auto-reader, 390,
1 EA**

3M Stock
B00014259
UPC
00707387767136



**3M™ Attest™ Rapid Steam
Biological Indicator, 1292E,
Brown Cap, 3 hr, 50/PAC, 4
PAC/CS, 200/CS**

3M Stock
7000053661
Previous 3M Stock
70200722414
UPC
30707387508556



**3M™ Tegaderm™ I.V.
Transparent Film Dressing with
Adhesive-Free Window, 1668,
4-3/4 in x 4-3/4 in, 25/ct
4ct/Case**

3M Stock
7100058058
Previous 3M Stock
70200777012
UPC
50707387770384



**3M™ EO (ethylene oxide)
Abator Model 50AN System,
220-230V/1PH, 1 EA/CTN**

3M Stock
7000002785
Previous 3M Stock
70200738030
UPC
00707387524302



**3M™ Tegaderm™
Superabsorber Dressing**



**3M™ Attest™ Auto-Reader for
EO, 390G, 1/CS**

3M Stock
B00014260
UPC
00707387767143



**3M™ Attest™ Super Rapid
Steam Biological Indicator
Challenge Pack with Type 5 CI,
41482**



**3M™ Comply™ Label
Applicator, 1256B, 1 Each/Case**

3M Stock
7000002763
Previous 3M Stock
70200729344
UPC
00707387443825



**3M™ Attest™ Super Rapid
Steam Biological Indicator, 1491,
Blue Cap, 24 min, 50/CAR, 4
CAR/CS, 200/CS**

3M Stock
7000128725
Previous 3M Stock
70200763558
UPC
30707387762958



3M™ Bair Hugger™ Warming Blanket, 30000



3M™ Tegaderm™ CHG Chlorhexidine Gluconate I.V. Securement Dressing



3M™ Comply™ Bowie-Dick Test Pack, 1233LF, 6 Pack/Bag, 5 Bag/Case

3M Stock
7000002931

Previous 3M Stock
70200760745

UPC
50707387584158



3M™ Attest™ Auto-reader 490, plug B (NA)

3M Stock
B00014261

UPC
00707387785642



3M™ Promogran Prisma™ Collagen Matrix with ORC and Silver



3M™ Tegaderm™ CHG Chlorhexidine Gluconate Gel Pad, 1664, 1.94 in x 2.44 in, 25/CAR, 4 CAR/CS, 100/CS

3M Stock
B5005209001

UPC
00707387791391



3M™ Comply™ Sterilization Load Labels



3M™ Attest™ Super Rapid Steam Biological Indicator, 1492



3M™ Tegaderm™ CHG Chlorhexidine Gluconate I.V. Port Dressing



3M™ Cavilon™ Advanced Skin Protectant



3M™ Tegaderm™ +Pad Film Dressing with Non-Adherent Pad, 3500 Series



3M™ Attest™ Steam Dry Incubator, 118, Small, 1 Each/Case

3M Stock
B00014255

UPC
00707387095000



3M™ Adaptic™ Digit Non-Adhering Dressing



3M™ Multipore™ Dry Surgical Tape, 373X Series

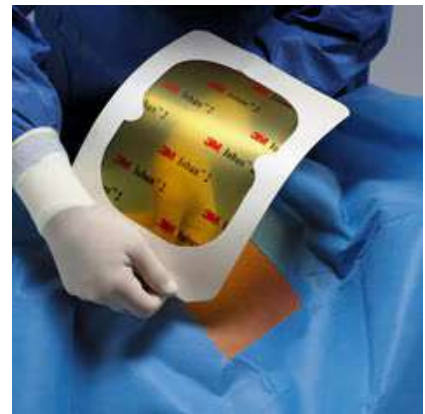

3M™ Ioban™ 2 Antimicrobial Incise Drape, 6600 Series



3M™ PICC/CVC Securement Device + 3M™ Tegaderm™ CHG Chlorhexidine Gluconate I.V. Securement Dressing



3M™ Attest™ Mini Auto-Reader, 490M, 1 Each/Case

3M Stock
B5005240014

UPC
50707387790702



3M™ Attest™ Steam Chemical Integrator



3M™ Attest™ Steam Biological Indicator, 1262



3M™ Tegaderm™ High Integrity Alginate Dressing



3M™ Tegaderm™ Transparent Film Dressing Frame Style



3M™ Attest™ Lead Free Steam Indicator Tape



3M™ Tegaderm™ I.V. Transparent Film Dressing with Border



3M™ Comply™ Bowie-Dick Plus Test Pack with Early Warning Test Sheet, 00135LF, 6 Each/Bag 5 Bag/case

3M Stock
700002930

Previous 3M Stock
70200760729

UPC
50707387584134



3M™ Promogran™ Collagen Matrix with ORC



3M™ Attest™ Biological Indicator Incubator, 129

3M Stock
B00043658

UPC
00707387029753



3M™ Tegaderm™ I.V. Advanced Securement Dressing



Nexcare™ Gentle Paper First Aid Tape T781-2PK, Tan, 1 in x 10 yds

3M Stock
70007088498

UPC
00051131227187



3M™ Steri-Gas™ EO Gas Cartridges, 4-100

3M Stock
7100044555

Previous 3M Stock
70200783788

UPC
50707387495522



3M™ Medical Tape 9952, Single Sided Polyester, 63# liner, CONFIGURABLE

3M Stock
7100127437

Previous 3M Stock
70000064892



**PREVENA PLUS™
CUSTOMIZABLE™ Dressing
Kit, PRE4055US, 5/pk**

3M Stock
B5005271000
UPC
00849554005303



**3M™ Touchless Care™ Zinc
Oxide Protectant Spray**



**ACTIV.A.C.™ Canister with Gel,
M8275058/5, 300 ml, 5/cs**

3M Stock
B5005265175
UPC
00849554001992



**3M™ Snap™ Plus -125 mmHg
Therapy Cartridge**



**3M™ V.A.C.® Granufoam™
Bridge Dressing**

3M Stock
B5005265138



**3M™ Prevena Restor™
BellaForm™ Incision
Management System**



3M™ Bair Hugger™ Warming Unit Replacement Controller, Model 90082, 1 EA

3M Stock
7100087545

Previous 3M Stock
70200790965

UPC
00707387774882



3M™ Veraflo™ Cleanse Choice Complete™ Dressing

3M Stock
B5005351004



3M™ Transpore™ White Surgical Tape, 1534/1544 Series



3M™ Microfluidic Diagnostic Tape 9795WT, Silicone Adhesive on White PET Tape, 7 mil, Configurable

3M Stock
7100241046

Previous 3M Stock
70000128226



3M™ Steri-Drape™ Minor Procedure Drape 1092NS, 500/CS

3M Stock
7000053750

Previous 3M Stock
70200745399

UPC
00707387023454



3M™ Medical Tape, 4576, Polyester Spunlace Nonwoven Extended Wear, 60# Liner, Configurable

3M Stock
7100274476

Previous 3M Stock
70000128325



3M™ Medipore™ Dress-It Pre-Cut Dressing Covers, 2950 Series



3M™ CoTran™ Polyethylene Tape, 9693, Config Roll

3M Stock
7100082650

Previous 3M Stock
70000203433



Prevena Plus™ Therapy Unit - 14 Day, PRE4010, 1 Kit

3M Stock
B5005265189



V.A.C. Canister, 500ml with Gel

3M Stock
B5005265177



3M™ Snap™ Plus Therapy Strap

3M Stock
B5005265163



KERRAPRO™ Pressure Reducing Pad



**3M™ V.A.C.® Granufoam™
Bridge XG Dressing**

3M Stock
B5005265139



**3M™ Snap™ Advanced
Dressing Kit**



**PREVENA DUO™ with PEEL &
PLACE™ Dressing,
PRE1121US, 13 cm/13 cm, 5
Kits/Case**

3M Stock
B5005265115



**3M™ Nu-Derm™ Standard
Hydrocolloid Dressing**

3M Stock
B5005265090



**KERRAFOAM™ Gentle Border
Foam Dressing**



**3M™ CoTran™ Ethylene Vinyl
Acetate Membrane Film, 9702,
Config Roll**

3M Stock
7100000164
Previous 3M Stock
70000065055



3M™ Bair Hugger™ Warming Blanket 54500, Adult Underbody, 10/Case

3M Stock
B00042317

UPC
50707387790146



3M™ Bair Hugger™ Warming Blanket 63500, Full Access Underbody, 5/Case

3M Stock
B00042300

UPC
50707387790221



3M™ Bair Hugger™ Warming Blanket 31000, Pediatric, 10/Case

3M Stock
B00042291

UPC
50707387790061



3M™ Cavilon™ Moisturizing Hand Lotion 9205

3M Stock
B00042122

UPC
50707387505528



3M™ Attest™ Steam Biological Indicator, 1262-S, Brown Cap, 48 hr, 300/CAR, 2 CAR/CS, 600/CS

3M Stock
7000053811

Previous 3M Stock
70200750589

UPC
30707387575169

**3M™ Steri-Drape™ (1191NS)
90" (229cm)**

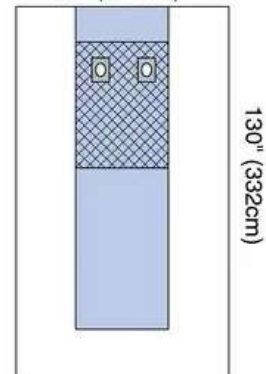

3M™ Steri-Drape™ Femoral Angiography Drape, 20 per Case, 1191NS

3M Stock
7000053745

Previous 3M Stock
70200745035

UPC
00707387565732

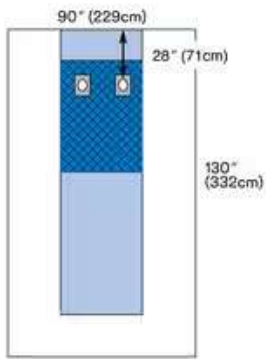

3M™ Steri-Drape™ Femoral Angiography Drape 1191

3M Stock
7000002635

Previous 3M Stock
70200647975

UPC
50707387229110

3M™ Littmann® Cardiology IV™ Diagnostic Stethoscope

3M™ Coban™ 2 Two-Layer Compression System



3M™ Tegaderm™ Diamond Pattern Film Dressing

3M™ Synthetic Cast Padding

PREVENA PLUS™ 150 mL Canister, PRE4095, 150 ml, 5/pk

3M Stock
B5005265178

UPC
00849554005310

3M™ Snap™ Therapy Cartridge family product image



3M™ Snap™ Therapy Cartridge

3M™ V.A.C.® Granufoam™ Dressing

SNAP™ Bridge Dressing Kit (Foam), BKTF14X11/10, 14 cm x 11 cm, 10/pk

3M Stock
B5005265128

UPC
00849554006317



NU-DERM™ Alginate Wound Dressing, AWD404, 10 cm x 10 cm, 10 ea/bx

3M Stock
B5005265104

UPC
15051978002246

3M™ Adaptic™ Touch One One-Sided Non-Adhering Silicone Dressing

3M Stock
B5005265092

SILVERCEL™ Antimicrobial Alginate Dressing



3M™ Bair Hugger™ Warming Unit Replacement Hose, Model 90081, 1 EA

3M Stock
7100087612

Previous 3M Stock
70200790957

UPC
00707387774875



3M™ Ultra Detail Plus Veterinary X-ray Film (Green sensitive), 8" x 10"

3M Stock
70200730409

UPC
30051115053000



3M™ Ultra Detail Plus Veterinary X-ray Film (Green sensitive), 10" x 12"

3M Stock
70200730417

UPC
30051115053017



3M™ Ultra Detail Plus Veterinary X-ray Film (Green sensitive), 11" x 14"

3M Stock
70200730425

UPC
30051115053024



3M™ Ultra Detail Plus Veterinary X-ray Film (Green sensitive), 14" x 17"

3M Stock
70200730433

UPC
30051115053031



3M™ Tegaderm™ Hydrogel Wound Filler



FUTURO™ Comfort Fit Ankle Support 04037ENR, Adjustable

3M Stock
70007070470
UPC
00051131224629



3M™ Bair Hugger™ 700 Series Warming Unit Rolling Cart, 90090, 1 Each

3M Stock
7100242309
Previous 3M Stock
70201802322
UPC
00707387806620



3M™ Ranger™ Blood/Fluid Warming Unit, 24500, 120V-ENG-B, 1 Each

3M Stock
7100235902
Previous 3M Stock
70200793308
UPC
00707387803292



3M™ Scotchpak™ Polyester Backing Film Laminate, 1109, Config Roll

3M Stock
7100000235
Previous 3M Stock
70000201502



3M™ Medical Tape 9832W, Single Sided Polyurethane on White 78# Carrier, CONFIGURABLE

3M Stock
7100013211
Previous 3M Stock
70000127053



3M™ Scotchcast™ Conformable Roll Splint

3M Stock
B00046075



3M™ Microfoam™ Surgical Tape, 1528



3M™ Bair Hugger™ Warming Blanket 55000, Large Pediatric Underbody, 10/Case

3M Stock
B00042318

UPC
50707387790153



3M™ Bair Hugger™ Warming Blanket, 63700

3M Stock
B00042301



3M™ Bair Hugger™ + Warming Gown



3M™ Avagard™ Surgical and Healthcare Personnel Hand Antiseptic with Moisturizers



3M™ Single-use Clipper Blade Assembly 9670

3M Stock
7000030241

Previous 3M Stock
70200738725

UPC
00707387561444



3M™ Steri-Drape™ (2050)



Incise area:
23" x 23" (60cm x 60cm)

3M™ Steri-Drape™ 2 Incise
Drape 2051NS, Incise area 19
inches x 17 inches (50cm x
45cm), 150/Case

3M Stock
7000053492

Previous 3M Stock
70200559246

UPC
00707387098605

3M™ Steri-Drape™ 2 Incise
Drape 2050NS, 200/Case

3M Stock
7000053491

Previous 3M Stock
70200559238

UPC
00707387098599

3M™ Steri-Drape™ 2 Incise
Drape, 2050, Incise Area 60 cm
x 60 cm (23 1/2 in x 23 1/2 in),
10/Case, 4 Cartons/Case

3M Stock
7100238518

Previous 3M Stock
70201800284

UPC
50707387793079

Alternative ID
2050



3M™ Steri-Drape™ 2 Incise
Drape 2035NS, Bulk, Non
sterile, Incise area 3 7/8 IN x 7
7/8 IN, 200/CS

3M Stock
7000053487

Previous 3M Stock
70200559196

UPC
00707387098551

3M™ Steri-Drape™ 2 Incise
Drape, 2040, Incise Area 28 cm
x 41 cm (11 in x 16 1/8 in),
10/Case, 4 Cartons/Case

3M Stock
7100238520

Previous 3M Stock
70200539891

UPC
50707387793055

3M™ Steri-Drape™ Medium
Drape with Aperture 1030NS

3M Stock
7000053401

Previous 3M Stock
70200485798

UPC
00707387029357



3M™ Steri-Drape™ Medium Aperture Drape with Wide Adhesive Aperture 1033NS

3M Stock
7100024307
Previous 3M Stock
70200687203
UPC
00707387454579



3M™ Avagard™ Wall Bracket 9246, Molded, White, 16/CS

3M Stock
7100100286
Previous 3M Stock
70200776972
UPC
50707387770346

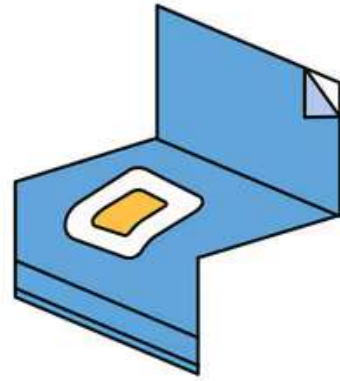

3M™ Steri-Drape™ Cesarean-Section Drape with Ioban™ 2 Incise Film and Clear Screen, 5 per Case, 6697CA

3M Stock
7100077378
Previous 3M Stock
70200789918
UPC
50707387773965



3M™ Littmann® Tunable Diaphragm and Rim Assembly, 33474, Black

3M Stock
7100256191
Previous 3M Stock
70201803957
UPC
00707387808754
Alternative ID
33474



3M™ Prevena Restor™ Axio-Form™ Incision Management System, PRE5501, 29 cm x 28 cm

3M Stock
B5005265192
UPC
00849554007826



3M™ Prevena™ 45 mL Canister

3M Stock
B5005265179



3M™ Snap™ Therapy Strap

3M Stock
B5005265165



3M™ V.A.C.® Simplace™ Dressing

3M Stock
B5005265141



SNAP™ Bridge Dressing Kit (Foam) with SecurRing™ Hydrocolloid, BKTf14X11S/10, 14 cm x 11 cm, 10/pk

3M Stock
B5005265129
UPC
00849554006362



3M™ Prevena™ Peel and Place Dressing Kit



3M™ Littmann® Lightweight II S.E. Stethoscope

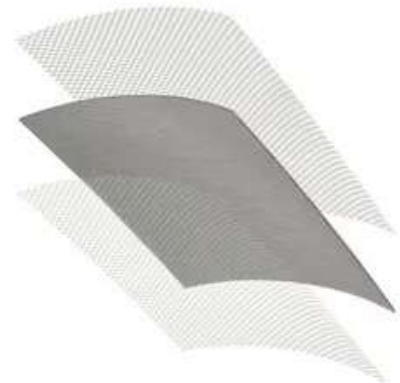

3M™ Silvercel™ Non-Adherent Antimicrobial Alginate Dressing

ADAPTIC TOUCH™ Non-Adhering Silicone Dressing

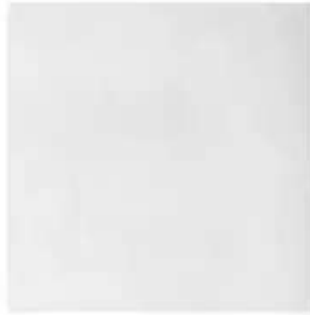

3M™ Adaptic™ Touch Non-Adhering Silicone Dressing

3M™ Fibracol™ Plus Collagen Wound Dressing with Alginate

3M™ Tegaderm™ High Gelling Alginate Dressing



3M™ Wound Cleanser
3M Stock
B10429501

3M™ Comply™ Indicator Tape Dispenser, M52, 1 Each/Case
3M Stock
7000002813
Previous 3M Stock
70200742503
UPC
00707387563516

3M™ Attest™ Instrument Protectors



3M™ Attest™ Steam Biological Indicator, 1261



3M™ CoTran™ Ethylene Vinyl Acetate Membrane Film, 9712, Configurable

3M Stock
7100065957

Previous 3M Stock
70000200082



3M™ Reston™ Self-Adhering Foam Pads/Rolls, 1560 Series



3M™ Bair Hugger™ Warming Unit, Model 77500



3M™ Bair Hugger™ Warming Blanket 57501, Spinal Underbody, 5/Case

3M Stock
B00042323

UPC
50707387790191



3M™ Bair Hugger™ Warming Gown Kit

3M™ Steri-Drape™ (9036)

23-7/8" (58cm)

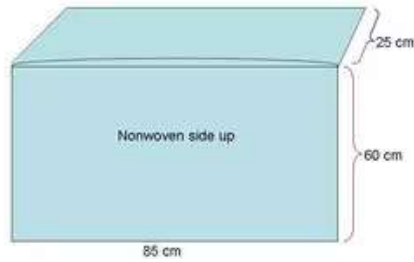
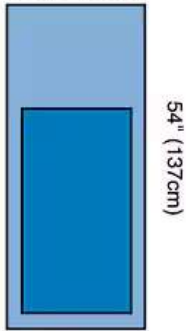

3M™ Steri-Drape™ Mayo Stand Cover, 9036, 60 Each/CAR, 4 Carton/Case

3M Stock
7000128615

Previous 3M Stock
70200737263

UPC
30707387560462

3M™ Steri-Drape™ Under Buttocks Drape with Cuff, 30 per Carton / 4 Cartons per Case, 9066

3M Stock
7000053860

Previous 3M Stock
70200757683

UPC
00707387581503

3M™ Steri-Drape™ Aperture Drape, Adjustable, 25 per Carton / 4 Cartons per Case, 9027L

3M Stock
7000053869

Previous 3M Stock
70200757774

UPC
00707387581596

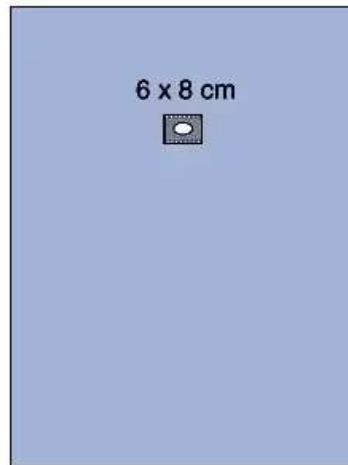
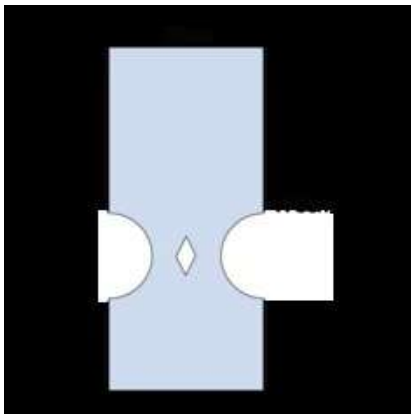

3M™ Steri-Drape™ Aperture Drape, 25 per Carton / 4 Cartons per Case, 9023

3M Stock
7000053566

Previous 3M Stock
70200687492

UPC
00707387456023

3M™ Steri-Drape™ Aperture Drape 9027, Adjustable, 40 per Carton / 4 Cartons per Case

3M Stock
7000002893

Previous 3M Stock
70200754813

UPC
00707387577438

3M™ Bair Hugger™ Warming Blanket 62200, Multi-position Upper Body, 10/Case

3M Stock
B00017229

UPC
50707387790252



**3M™ Vetrap™ Bandaging Tape
1418D Rundown Patch**

3M Stock
B00016466



**3M™ ElectroSurgical Reusable
Cable 21172**

3M Stock
7000053620
Previous 3M Stock
70200701913
UPC
00707387468057



**3M™ Medical Hook Fastener
7334, Low Profile, Configurable**

3M Stock
7100127448
Previous 3M Stock
70000127210



**3M™ Red Dot™ Soft Cloth
Monitoring Electrode**



**3M™ Tegaderm™ Alginate Ag
Silver Dressing 90307, 1 IN x 2
IN, 5 dressings/CT 4 CT/CS**

3M Stock
7000128710
Previous 3M Stock
70200760141
UPC
50707387583625



**3M™ Tegaderm™ Alginate AG
Silver Dressing 90305, Square,
6 IN X 6 IN 5/Cartron 4
Cartons/Case**

3M Stock
7100074337
Previous 3M Stock
70200760133
UPC
50707387583618





**3M™ Medical Tape 9926T,
Single Sided Tan Tricot Fabric,
83# Liner, Configurable**

3M Stock
7100127443

Previous 3M Stock
70000127061



**3M™ Tegaderm™ Transparent
Film Roll**



**3M™ Scotchcast™ Conformable
Splint**



Vetbond Tissue Adhesives

3M Stock
B00016067

UPC
00051115053603



**3M™ Coban™ NL Non-Latex
Self-Adherent Wrap with Hand
Tear 208X Series**



**ACE™ Brand Posture Corrector,
One Size - Adjustable**

3M Stock
CBGBLRUS1521

UPC
00051131222205



Nexcare™ Gentle Removal Eye Patch - Regular KRR-14, 2.24 in x 3.15 in (57 mm x 80 mm)

3M Stock
CBGBLRUS1511
UPC
00051131216808



Nexcare™ Foot Protection Tape FPT-05, 1 in x 5 yds (2.54 cm x 4.57 m)

3M Stock
CBGBLRUS1462
UPC
00051141994970



ACE™ Deluxe Ankle Brace 207736, One Size Adjustable

3M Stock
COBBLW014163
UPC
00051131203877



ACE™ Brand Wrist Support

3M Stock
COBBLW014104
UPC
00051131198258



Nexcare™ Waterproof Bandages, Cool Collection 594-20

3M Stock
COBBLW014042
UPC
00051131669901



Nexcare™ Cushioned Adhesive Pad AWP34, 3 in x 4 in

3M Stock
COBBLW014000
UPC
00051131197732



FUTURO™ Performance Knee Stabilizer

3M Stock
CBGBLW011052
UPC
00051131201569



FUTURO™ Night Wrist Support

3M Stock
CBGBLW011040
UPC
00051131201606



FUTURO™ Comfort Elbow Support

3M Stock
CBGBLW011027
UPC
00051131200975



FUTURO™ Performance Comfort Ankle Support, 01037ENR, Adjustable

3M Stock
CBGBLW011003
UPC
00051131200623



3M™ Littmann® Stethoscope Spare Parts Kit, Classic II Infant Assembly, 40013

3M Stock
7100060436
Previous 3M Stock
70200788357
UPC
00707387773007



3M™ Bair Hugger™ Warming Blanket 58501, Lithotomy Underbody, 10/Case

3M Stock
B00042325
UPC
50707387790207

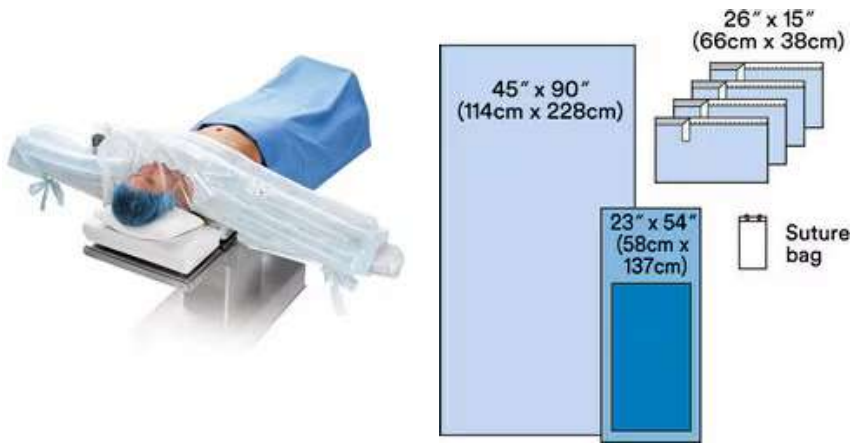

3M™ Bair Hugger™ Warming Blanket, 44000

3M Stock
B00042304

3M™ Steri-Drape™ Basic Set-Up Pack 9020A

3M Stock
7000002815
Previous 3M Stock
70200742602
UPC
00707387563592

3M™ Steri-Drape™ Urological Drape, 1071, 23 inch x 35 inch (60cm x 90cm), aperture size 2 inches (5cm), 10/Carton, 4 Cart...

3M Stock
7000002614
Previous 3M Stock
70200558479
UPC
30707387018741

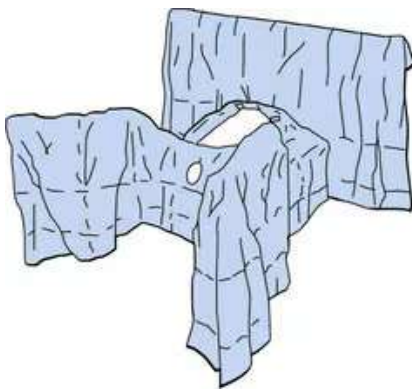

3M™ Steri-Drape™ (9063)
100" (254cm)

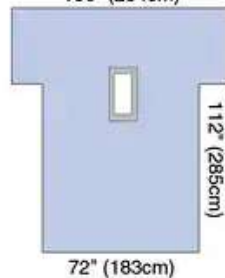

Laparoscopy Drape - Lithotomy Position_Illustrator File 1032

3M™ Steri-Drape™ Laparoscopy Drape 1032

3M Stock
7000002774
Previous 3M Stock
70200737073
UPC
30707387381760

3M™ Steri-Drape™ Laparotomy/Laparoscopy Drapes 9063

3M Stock
7000002779
Previous 3M Stock
70200737255
UPC
30707387560455

3M™ Steri-Drape™ Laparoscopic Pack 1032P, 5 per Carton / 2 Cartons per Case

3M Stock
7000030255
Previous 3M Stock
70200742230
UPC
00707387563257



3M™ Steri-Drape™
Laparotomy/Laparoscopy
Drapes 1031

3M Stock
7000002775

Previous 3M Stock
70200737081

UPC
30707387381814



3M™ Steri-Drape™
Laparoscopic Drape 1032NS,
Lithotomy Position, 95 IN,
aperture size 10 1/2 IN x 11 1/2
IN, 16/CS

3M Stock
7000053697

Previous 3M Stock
70200737099

UPC
00707387560157



Stethoscope Binaural Assembly



3M™ Synthetic Cast Stockinet



Nexcare™ Gentle Removal Eye
Patch - Small KRJ-14, 1.96 in x
2.36 in (50 mm x 60 mm)

3M Stock
CBGBLRUS1512

UPC
00051131216815



ACE™ Brand Sport Deluxe Back
Stabilizer, Adjustable

3M Stock
CBGBLRUS1499

UPC
00051131205468



Nexcare™ Strong Hold Pain-Free Removal Adhesive Pad
SSD34, 3 in x 4 in (76,2 mm x 101 mm)

3M Stock
CBGBLWUS1371

UPC
00051131211964



ACE™ Brand Sports Tape

3M Stock
COBBLW014204

UPC
00051131200289



ACE™ Brand Compression Elbow Support

3M Stock
COBBLW014177

UPC
00051131203952



ACE™ Brand Reversible Splint Wrist Brace

3M Stock
COBBLW014105

UPC
00051131200166



Nexcare™ Tegaderm™ Transparent Dressing

3M Stock
COBBLW014045

UPC
00051131641143



Nexcare™ Absolute Waterproof Tape

3M Stock
COBBLW014001

UPC
00051135811153



FUTURO™ Knee Strap,
09189EN, Adjustable

3M Stock
CBGBLW011053
UPC
00051131200685



FUTURO™ Performance
Comfort Wrist Support

3M Stock
CBGBLW011041
UPC
00051131200616



FUTURO™ Comfort Elbow with
Pressure Pads

3M Stock
CBGBLW011028
UPC
00051131200555



FUTURO™ Slim Silhouette
Ankle Support 95347EN,
Small/Medium

3M Stock
CBGBLW011004
UPC
00051131201705



3M™ Nasogastric Securement
Device



3M™ V.A.C.® Simplace™ EX
Dressing

3M Stock
B5005265142



3M™ Prevena™ Peel and Place Incision Management System



3M™ AbThera™ Advance Open Abdomen Dressing

3M Stock
B5005265106



FUTURO™ Compression Stabilizing Wrist Brace, 48402ENR, Right Hand, Large/Extra-Large

3M Stock
70007017638
UPC
00051131201576



FUTURO™ Compression Stabilizing Wrist Brace, 48401ENR, Left Hand, Small/Medium

3M Stock
70007017620
UPC
00051131200593



FUTURO™ Compression Stabilizing Wrist Brace, 48403ENR Left Hand, Large/Extra-Large

3M Stock
70007017646
UPC
00051131201583



FUTURO™ Compression Stabilizing Wrist Brace, 48400ENR, Right Hand, Small/Medium

3M Stock
70007017612
UPC
00051131200609



3M™ Bair Hugger™ Animal Health Underbody Blanket



3M™ Tegaderm™ Silicone Foam Dressing



3M™ SoluPrep™ S Sterile Antiseptic Solution 2% CHG / 70% IPA



3M™ Tube Securement Device



3M™ Microfluidic Diagnostic Hydrophilic Film, 9938

3M Stock
B5005325043



Nexcare™ Opticlude™ Orthoptic Eye Patch 1537, Junior, 2.44 in x 1.81 in (62 mm x 46 mm) 20 Patches/Box

3M Stock
CBGBLRUS1518

UPC
00051131000223



ACE™ Brand Dual Strap Knee Support

3M Stock
CBGBLWUS1377
UPC
00051131193178

ACE™ Brand Instant Cold Pack

3M Stock
COBBLW014108
UPC
00051131209374

Nexcare™ Tegaderm™+Pad Transparent Dressing

3M Stock
COBBLW014046
UPC
00051131948914



Nexcare™ All-in-One Adhesive Pad H3564, 2 3/8 in x 4 in (6 cm x 10 cm)

3M Stock
COBBLW014030
UPC
00051131835566

Nexcare™ Durable Cloth First Aid Tape

3M Stock
COBBLW014017
UPC
00051131653016

3M™ Bufo-Puf™ Gentle Facial Sponge, 915-06, 1 ct.

3M Stock
CBGBLW761189
UPC
00051131185036



FUTURO™ Sport Knee Support

3M Stock
CBGBLW011054
UPC
00051131201408



FUTURO™ Performance Comfort Elbow Support

3M Stock
CBGBLW011029
UPC
00051131200630



FUTURO™ Sport Ankle Support

3M Stock
CBGBLW011005
UPC
00051131201439



3M™ Microfluidic Diagnostic Hydrophilic Film, 9901PB

3M Stock
B5005455014



3M™ V.A.C.® Tubing Cap

3M Stock
B5005265167

SNAP™ SecurRing™ Hydrocolloid product image

SNAP™ SecurRing™ Hydrocolloid, SRNG10, 2 in, 10/pk

3M Stock
B5005265131
UPC
00849554006362



3M™ Adaptic™ Non-Adhering Dressing



3M™ Bair Hugger™ Warming Blanket, 63000, Sterile Cardiac, 5/Case

3M Stock
B5005241003
UPC
50707387804140



3M™ PICC / CVC Securement Device + Tegaderm™ I.V. Advanced Securement Dressing



3M™ Micropore™ S Surgical Tape, 277X Series

V.A.C.® SIMPLICITY™ Therapy System product image



3M™ V.A.C.® Simplicity Therapy Unit

3M Stock
B5005265195

3M™ Nu-Gel™ Hydrogel with Alginate

3M Stock
B5005265144



**3M™ 9969 Diagnostic
Microfluidic Adhesive Transfer
Medical Tape**

3M Stock
7100116011

Previous 3M Stock
70200783655

UPC
0070738771133



**3M™ V.A.C. Veraflo Cleanse
Choice™ Dressing**

3M Stock
B5005265132



**PREVENA PLUS™ 125 Therapy
Unit, PRE4000US, 1/ea**

3M Stock
B5005265120



**3M™ AbThera™
SensaT.R.A.C.™ Open
Abdomen Dressing**

3M Stock
B5005265108



**3M™ Ranger™ Cleaning Tool
Accessory, Model 90030,
12/Case**

3M Stock
7100092605

Previous 3M Stock
70200793753

UPC
50707387781946



**3M™ Bair Hugger™
Temperature Control Holder,
Model 90073, 1 EA**

3M Stock
7100087540

Previous 3M Stock
70200790940

UPC
00707387774868



3M™ CoTran™ Melt-Blown Polyurethane Tape, 9699, Configurable

3M Stock
7100119879

Previous 3M Stock
70000200330



3M™ Bair Hugger™ 500 and 700 Series Sheet Clip, Model 90063, 1 EA

3M Stock
7100087661

Previous 3M Stock
70200791872

UPC
00707387775797



3M™ Bair Hugger™ Temperature Monitoring Control Unit, 37000, 120V-ENG-A, 1 Each

3M Stock
7100236002

Previous 3M Stock
70201802090

UPC
00707387792961

Alternative ID
120V-ENG-A



3M™ Medical Silicone Tape 2476P, Single Sided Polyester Spunlace Nonwoven, Configurable

3M Stock
7100013596



3M™ Steri-Drape™ Back Table Cover, 9072, 39 in x 59 in, 20/Case, 4 Cartons/Case

3M Stock
7000002690

Previous 3M Stock
70200687997

UPC
50707387784725



3M™ CoTran™ Backing Polyethylene Monolayer Backing Film, 9719, Config Roll

3M Stock
7100065958

Previous 3M Stock
70000200132



3M™ Bair Hugger™ Warming Blanket, 56000, Cath Lab

3M Stock
B00042329



3M™ Bair Hugger™ Warming Blanket 54200, Dual Port Torso, 10/Case

3M Stock
B00042305

UPC
50707387790139



3M™ Bair Hugger™ Flex Warming Gown Kit



3M™ Avagard™ Hands Free Wall Dispenser 9228, 4 Each/Case

3M Stock
7000030324
Previous 3M Stock
70200756990

UPC
50707387580518

**3M™ Steri-Drape™ (9090NS)
118" (300cm)**

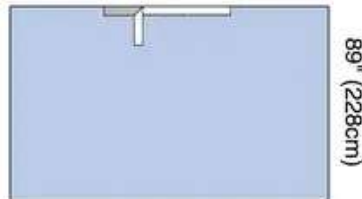

3M™ Steri-Drape™ Adhesive Drape Sheet 9090NS, 118 IN x 89 IN, 20/CS

3M Stock
7000053602
Previous 3M Stock
70200688268

UPC
00707387456757

**3M™ Steri-Drape™ (9088NS)
98" (250cm)**

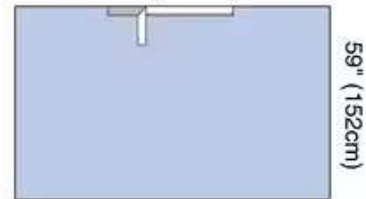

3M™ Steri-Drape™ Adhesive Drape Sheet 9088NS, 98 IN x 59 IN, 50/CS

3M Stock
7000053600
Previous 3M Stock
70200688227

UPC
00707387456733

3M™ Steri-Drape™ (9087NS)

72" (183cm)

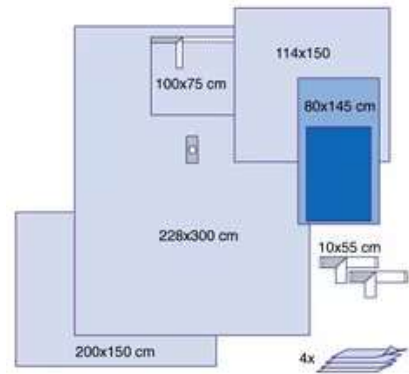
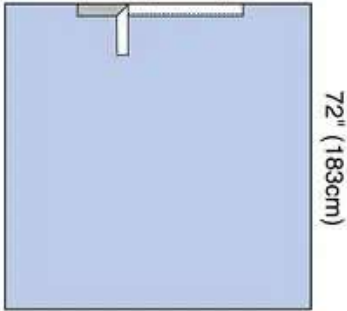

3M™ Steri-Drape™ Adhesive
Drape Sheet 9087NS, 72 IN x 72
IN, 50/CS

3M Stock
7000053598

Previous 3M Stock
70200688201

UPC
00707387456719

3M™ Steri-Drape™ Orthopaedic
Surgical Pack, 9014, 5/Carton,
2/Case

3M Stock
7000030182

Previous 3M Stock
70200687476

UPC
50707387457612

3M™ Steri-Drape™ Extremity
Surgical Pack 9004, 5 per
Carton / 2 Cartons per Case

3M Stock
7000002685

Previous 3M Stock
70200687419

UPC
50707387455953

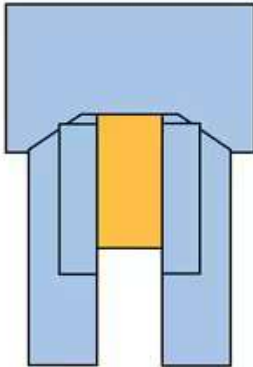

3M™ Steri-Drape™
Cardiovascular Pack with
Ioban™ 2 Incise Film 6677P,
4/Case

3M Stock
7000030321

Previous 3M Stock
70200756461

UPC
00707387579586

3M™ Scotchpak™ Polyester
Packaging Film Laminate,
MA250M, Config Roll

3M Stock
7100119887

Previous 3M Stock
70000202344

3M™ Precise™ Pistol Grip Skin
Stapler

3M Stock
B00038538

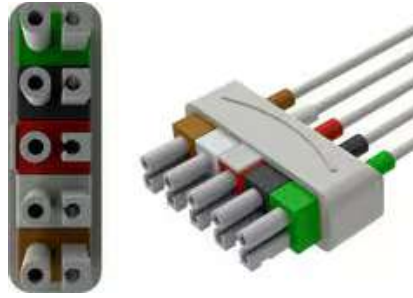

**3M™ Littmann® Diaphragm for
Littmann® Electronic Model
3200 Stethoscope, Black**

3M Stock
7100008783

Previous 3M Stock
78808326488

UPC
00707387777357

ECG Reusable Leadwire

**3M™ Steri-Strip™ Wound
Closure System**

3M Stock
B00036351



**3M™ Medical Tape 1523, Single
Sided Blush Tan Polyethylene,
63# Liner, Configurable**

3M Stock
7100085732

Previous 3M Stock
7000005804

**3M™ CoTran™ Nonwoven
Polyester Tape, 9698, Config
Roll**

3M Stock
7100065992

Previous 3M Stock
70000201700

**3M™ Steri-Drape™ Stockinette,
Small, 25 per Carton / 4 Cartons
per Case, 9109**

3M Stock
7000053846

Previous 3M Stock
70200756420

UPC
00707387579548

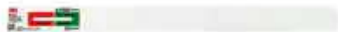

3M™ Attest™ Steam Chemical Integrator with Extender



3M™ Bair Hugger™ Warming Blanket 57000, Surgical Access, 10/Case

3M Stock
B00042332

UPC
50707387790184



3M™ Bair Hugger™ Warming Blanket 55501, Pediatric Underbody, 10/Case

3M Stock
B00042292

UPC
50707387790160



3M™ Bair Hugger™ Warming Blanket, 11101, Outpatient

3M Stock
B00042278



3M™ Cavilon™ Durable Barrier Cream



3M™ Cavilon™ No Sting Barrier Film

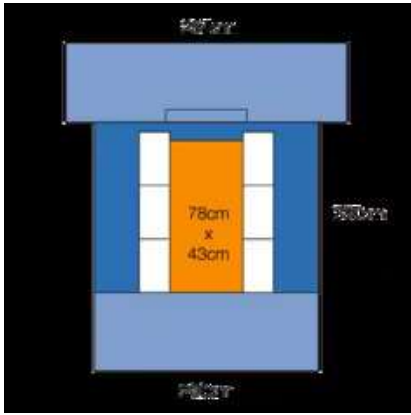

3M™ Steri-Drape™ Cardio/Chest Drape with loban™ 2 Incise Film 6682

3M Stock
7000030283
Previous 3M Stock
70200748492
UPC
00707387568146



3M™ Steri-Drape™ Adhesive Split Sheet, 9054, 195 cm x 300 cm, 12/Case, 2/Case

3M Stock
7000053738
Previous 3M Stock
70200744749
UPC
30707387560387



3M™ Steri-Drape™ Adhesive Split Sheet, Bilateral, 183cm x 200cm, 14 per Carton / 2 Cartons per Case, 9046L

3M Stock
7000053966
Previous 3M Stock
70200763996
UPC
00707387763381

3M™ Steri-Drape™ (1094)

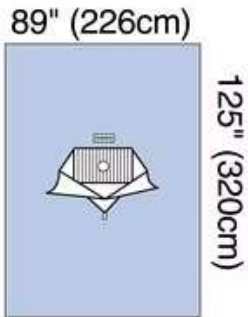

3M™ Steri-Drape™ Adhesive Split Sheet, 1094, 226 cm x 320 cm, 20/Case

3M Stock
7000030161
Previous 3M Stock
70200661612
UPC
50707387032901



3M™ Steri-Drape™ Adhesive Split Sheet 9045

3M Stock
700002687
Previous 3M Stock
70200687773
UPC
50707387456301

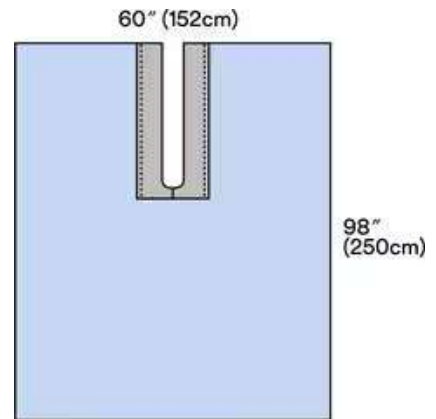

3M™ Steri-Drape™ Adhesive Split Sheet 9044

3M Stock
7000030185
Previous 3M Stock
70200687757
UPC
50707387456288

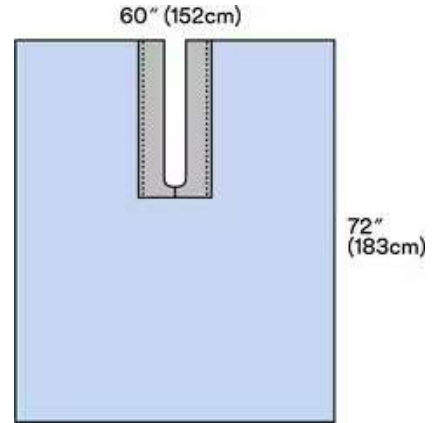

3M™ Steri-Drape™ Adhesive Split Sheet 9045NS Non-sterile

3M Stock
7000053581
Previous 3M Stock
70200687781
UPC
00707387456313

3M™ Steri-Drape™ Adhesive Split Sheet 9044NS Non-sterile

3M Stock
7000053580
Previous 3M Stock
70200687765
UPC
00707387456290

3M™ Steri-Drape™ Adhesive Split Sheet 9043

3M Stock
7000053578
Previous 3M Stock
70200687732
UPC
50707387456264

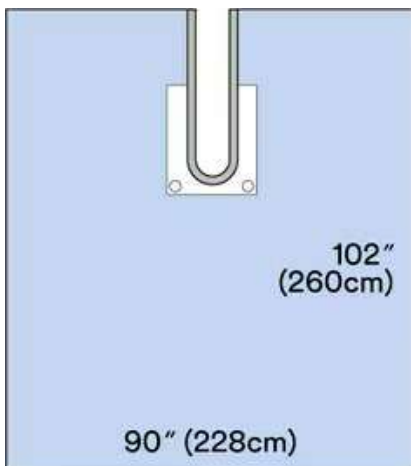

3M™ Steri-Drape™ Adhesive Split Sheet, 9196, 228 cm x 260 cm, 10/Cartron, 2/Case

3M Stock
7000002777
Previous 3M Stock
70200737206
UPC
30707387560400

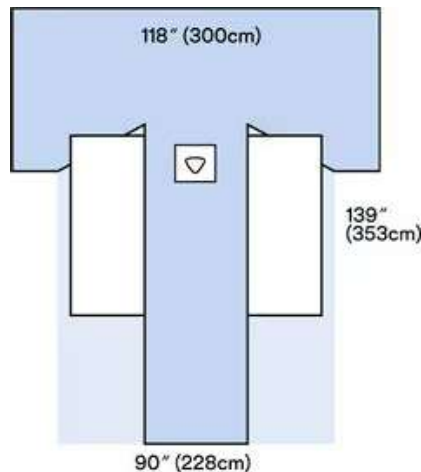

3M™ Steri-Drape™ Adhesive Split Sheet, 9055, 300 cm x 353 cm, 8/Cartron, 2/Case

3M Stock
7000002826
Previous 3M Stock
70200744970
UPC
30707387565542

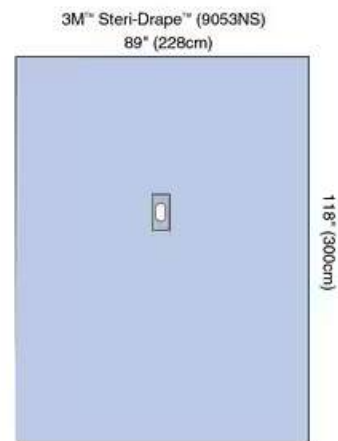

3M™ Steri-Drape™ Extremity Drape 9053NS, 90 IN x 118 IN, aperture 2 1/4 IN x 3 1/8 IN, 18/CS

3M Stock
7100045699
Previous 3M Stock
70200687880
UPC
00707387456399



**3M™ Littmann® Diaphragm for
Littmann® Electronic Model
3100 Stethoscope, Gray**

3M Stock
7100009128
Previous 3M Stock
78808326470
UPC
00707387777364

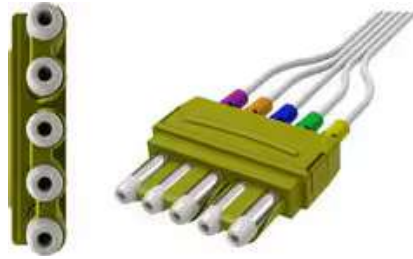

ECG Disposable Leadwire



**3M™ Red Dot™ Pre-Wired
Electrode, 2200 Series**



**Futuro™ Comfort Fit Wrist
Support Adjustable 04036ENR**

3M Stock
70007070496
UPC
00051131224636



**3M™ Scotchcast™ Soft Cast
Casting Tape**



**3M Vetcast Plus Veterinary
Casting Tape**

3M Stock
B00034999
UPC
50051115052731



3M™ CuroS™ Disinfecting Cap
for Needleless Connectors,
CFF1



3M™ Blenderm™ Surgical Tape,
1525 Series



3M™ Durapore™ Surgical Tape



3M™ Bair Hugger™ Warming
Blanket 61000, Full Body
Surgical, 10/Case

3M Stock
B00042333
UPC
00707387790219



3M™ Bair Hugger™ Warming
Gown



3M Clear Custom Collar

3M Stock
B00042057
UPC
50051115053394



3M™ Avagard™ D Instant Hand Antiseptic with Moisturizers



Futuro™ Shoulder Hot/Coldwrap 46822ENR, Adjustable

3M Stock
CBGBLRUS1524

UPC
00051131221697



Nexcare™ Opticlude™ Orthoptic Eye Patch 1539, Regular, 3.18 in x 2.18 in (81 mm x 55.5 mm) 20 patches/box

3M Stock
CBGBLRUS1519

UPC
00051131000230



Nexcare™ Advanced Healing Waterproof Hydrocolloid Pads, AHD-06, 6 ct. 3 in x 4 in

3M Stock
CBGBLRUS1487

UPC
00051131215689



Nexcare™ Advanced Waterproof Bandages AWB-10, 3 sizes

3M Stock
CBGBLRUS1486

UPC
00051131204713



ACE™ Cold/Hot Compress Back Wrap 203960

3M Stock
COBBLW014206

UPC
00051131204041

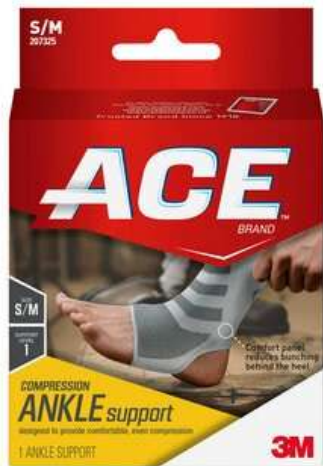

ACE™ Brand Compression Ankle Support

3M Stock
COBBLW014166
UPC
00051131212213



ACE™ Brand Compression Knee Support

3M Stock
COBBLW014114
UPC
00051131203785



Nexcare™ Waterproof Bandages

3M Stock
COBBLW014047
UPC
00051131997608



3M™ Buf-Puf™ Regular Facial Sponge, 910-06, 1 ct.

3M Stock
CBGBLW761190
UPC
00051131910010



FUTURO™ Sport Hinged Knee Brace

3M Stock
CBGBLW011055
UPC
00051131201590



FUTURO™ For Her Wrist Support

3M Stock
CBGBLW011043
UPC
00051131201682

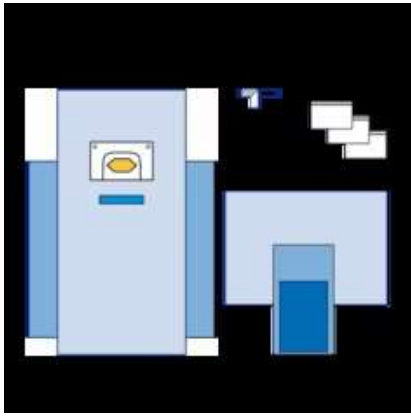

3M™ Steri-Drape™ Craniotomy Pack with loban™ 2 Incise Film, 7 per Case, 6687 P

3M Stock
7000053850
Previous 3M Stock
70200756479
UPC
00707387579593



FUTURO™ Sport Adjustable Elbow Support, 09038EN

3M Stock
CBGBLW011030
UPC
00051131201422

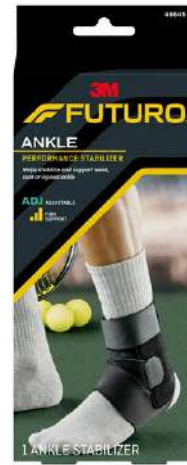

FUTURO™ Ankle Performance Stabilizer, 46645ENR Adjustable

3M Stock
CBGBLW011006
UPC
00051131201514



3M™ Red Dot™ Monitoring Electrode with Foam Tape and Sticky Gel, 2500 Series



Stethoscope Nonchill Bell Sleeve



3M™ Littmann® Classic II Pediatric Stethoscope



3M™ Tegaderm™ High Performance Non-adhesive Foam Dressing



3M™ Attest™ Biological Indicator Incubator, 127, 1/Case

3M Stock
B00014268

UPC
00707387024796



3M™ V.A.C.® Rx4 Therapy Unit

3M Stock
B5005265196



3M™ ActiV.A.C.™ Therapy System with iOn Progress™ Remote Therapy Monitoring

3M Stock
B5005265183



3M™ V.A.C. Veralink™ Cassette

3M Stock
B5005265169



V.A.C. VERAFLU CLEANSE™ Dressing, ULTVCL05MD, Medium, 5/pk

3M Stock
B5005265133

UPC
00849554001329



**PREVENA PLUS™
CUSTOMIZABLE™ System Kit,
PRE4001US, 7 day pump, 1/ea**

3M Stock
B5005265121



**DERMATAC™ Drape,
DTAC10LDP, 10/pk**

3M Stock
B5005265109
UPC
00849554005242



**3M™ Littmann® CORE Digital
Stethoscope**



**3M™ Bair Hugger™ Warming
Unit, Model 67500**



**Nexcare™ Cushioned
Waterproof Bandages**

3M Stock
CBGBLRUS1500
UPC
00051131997172



**FUTURO™ Dual Strap Knee
Support, 09195ENR, Adjustable**

3M Stock
CBGBLWUS1440
UPC
00051131212718

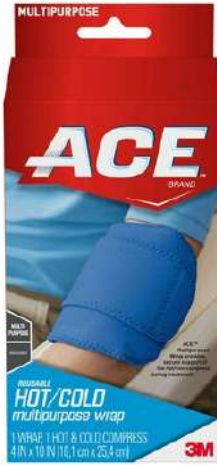

ACE™ Brand Hot & Cold Multi-Purpose Wrap

3M Stock
COBBLW014207
UPC
00051131204034

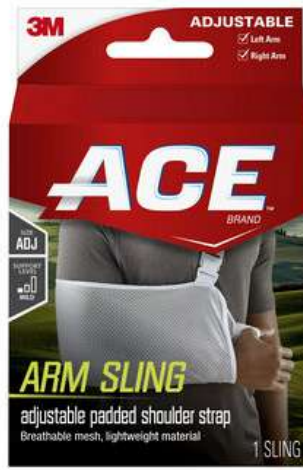

ACE™ Arm Sling 207395, One Size Adjustable

3M Stock
COBBLW014180
UPC
00051131198104



ACE™ Brand Plantar Fasciitis Sleep Support

3M Stock
COBBLW014167
UPC
00051131198241



ACE™ Brand Adjustable Knee Support

3M Stock
COBBLW014116
UPC
00051131199231



ACE™ Brand Compression Ankle Support

3M Stock
COBBLW014053
UPC
00051131203884



Nexcare™ Cold Pack 2646PEG

3M Stock
COBBLW014034
UPC
00051131184138



Nexcare™ Flexible Clear First Aid Tape

3M Stock
COBBLW014019

UPC
00051131913820



Nexcare™ Athletic Cloth Tape 870-B , 1.5 in x 12.5 yds

3M Stock
COBBLW014004

UPC
00051131620988



3M™ Buf-Puf™ Body Sponge, 908-06, 1 ct.

3M Stock
CBGBLW761191

UPC
00051131908017



FUTURO™ Performance Knee Support

3M Stock
CBGBLW011056

UPC
00051131201385



FUTURO™ Sport Adjustable Wrist Support, 09033EN, ADJ

3M Stock
CBGBLW011044

UPC
00051131201415



FUTURO™ Sport Moisture Control Ankle Support 48635EN, Adjustable

3M Stock
CBGBLW011007

UPC
00051131200579



3M™ Medical Tape 9865, Single Sided Polyethylene, 63# Liner, Configurable

3M Stock
7100013845
Previous 3M Stock
70000065402



3M™ Steri-Gas™ EO (ethylene oxide) Cartridges 4-134

3M Stock
7100044557
Previous 3M Stock
70200783812
UPC
50707387495515



3M™ Transpore™ Surgical Tape, 1527 Series



3M™ Micropore™ Surgical Tape, 1530 Series



3M™ Medical Foam Tape 9776, Single Sided Polyethylene, 72# liner, Configurable

3M Stock
7100000071
Previous 3M Stock
70000063589



3M™ Comply™ Thermalog™ Steam Chemical Integrator, 2134MM, Cls 5, 3/4 x 4 in (1.9 x 10.16 cm), 250/PAC, 8 PAC/CS, 2000/CS

3M Stock
7000053626
Previous 3M Stock
70200702812
UPC
50707387469196



3M™ Kind Removal Silicone Tape, single-patient use roll 2770S-2, 2 inch x 1 1/2 yard (5cm x 1,3m)

3M Stock
7000053989

Previous 3M Stock
70200764523

UPC
30707387763641



3M™ CoTran™ Polyethylene Backing Film, 9720, Config Roll

3M Stock
7100000161

Previous 3M Stock
70000064363



3M™ Bair Hugger™ Warming Blanket, 64500

3M Stock
B00042337



3M™ Bair Hugger™ Plus Warming Gown with Booties 83102, Small Size, 20/Case

3M Stock
B00042199

UPC
50707387774627



3M™ Steri-Drape™ Medium Drape with Incise Film and Pouch, 1061, 130 cm x 130 cm (51 in x 51 in), 10/CTN, 4 CTN/Case

3M Stock
7000030133

Previous 3M Stock
70200542903

UPC
30707387074068

Alternative ID
1061

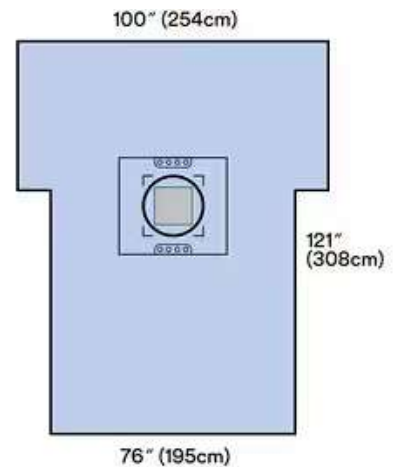

3M™ Steri-Drape™ Caesarean-Section Pack 7965P, 5 per Carton / 2 Cartons per Case

3M Stock
7000030260

Previous 3M Stock
70200742289

UPC
00707387563301



3M™ Medical Tape 1509EL, Double Sided Transparent Polyethylene, 80# Liner, CONFIGURABLE

3M Stock
7100127435

Previous 3M Stock
7000027337



ECG Monitoring Cable



3M™ Red Dot™ Resting EKG Electrode, 2300 Series



3M Medical Materials Technologies 2484 Polyurethane Single-Coated Tape



3M™ Steri-Strip™ Reinforced Adhesive Skin Closures

3M™ Foam Monitoring Electrode, 2200 Series

3M™ Medical Silicone Tape, 2484, Hi-Tack Single Sided Polyurethane, Configurable

3M Stock
7100290699

Previous 3M Stock
70000128499

Alternative ID
2484



3M™ Tegaderm™ Hydrocolloid Dressing



3M™ Scotchcast™ Wet or Dry Cast Padding



3M™ V.A.C.® Ultra Therapy Unit
3M Stock
B5005265197



ACTIV.A.C.™ Therapy Unit,
340000, 1/ea
3M Stock
B5005265184
UPC
00878237008188



3M™ V.A.C. VeraT.R.A.C. Duo™ Tube Set
3M Stock
B5005265170

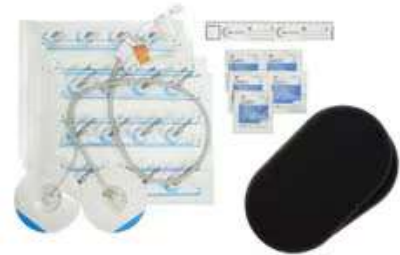

V.A.C. VERAFL0™ Dressing,
ULTVFL05SM, Small, 5/pk
3M Stock
B5005265134
UPC
00849554001299

PREVENA RESTOR
ARTHRO•FORM™
Dressing, product image

3M Dermatac Drape with
V.A.C. Granufoam Dressing
Kit product image



3M™ Prevena Restor™
ArthroForm™ Dressing

3M™ Dermatac™ Drape with
V.A.C.® Granufoam™ Dressing
Kit

Animalintex Poultice

3M Stock
B00035313

UPC
00051115052798



3M™ Scotchcast™ Plus Casting
Tape 82000 Series

3M™ Attest™ Steam Chemical
Integrator Test Pack, 41360,
Type 5, 16/CAR, 4 CAR/CS,
64/CS

3M™ Medical Tape 9841, Single
Sided Polyurethane, 60# liner,
Configurable

3M Stock
B5005158063
UPC
50707387787245

3M Stock
7100012481
Previous 3M Stock
70000065311
Alternative ID
9841



3M™ Bair Hugger™ 500 and 700 Series Power Cord, Model 90224, 120V, North America/Japan, 1 EA

3M Stock
7100087678
Previous 3M Stock
70200791864
UPC
0070738775780



FUTURO™ Comfort Fit Elbow Support 04038ENR, Adjustable

3M Stock
70007070462
UPC
00051131224612



Nexcare™ Toe Blister Comfort Cushions CCT-05, 2 3/4 x 1 (7 cm x 2,54 cm)

3M Stock
CBGBLRUS1468
UPC
00051131212701



FUTURO™ Comfort Compression Back Support

3M Stock
CBGBLWUS1441
UPC
00051131211865



ACE™ Brand Knee Strap

3M Stock
COBBLW014121
UPC
00051131198210

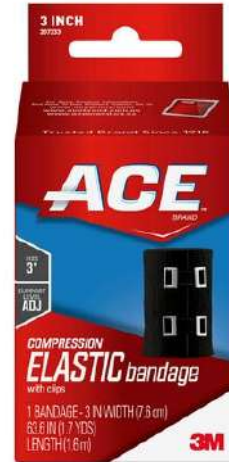

ACE™ Brand Elastic Bandage with Clips – Black

3M Stock
COBBLW014055
UPC
00051131215702



Nexcare™ Gentle Paper First Aid Tape

3M Stock
COBBLW014020

UPC
00051131913868



FUTURO™ Comfort Knee with Stabilizers

3M Stock
CBGBLW011057

UPC
00051131200753



FUTURO™ Wrist Support Strap, 46378ENR, Adjustable, Black

3M Stock
CBGBLW011045

UPC
00051131201392



FUTURO™ Tennis Elbow Strap

3M Stock
CBGBLW011032

UPC
00051131201545



FUTURO™ Quick Strap Ankle Support 47736EN, Adjustable

3M Stock
CBGBLW011008

UPC
00051131196926



3M™ V.A.C.® Peel and Place Dressing Kit



3M™ Scotchcast™ Quick Step Splint



3M™ V.A.C.® Y-Connector
3M Stock
B5005265172



3M™ V.A.C.® Drape
3M Stock
B5005265136



Prevena Restor™ Axio-Form™ Dressing Kits, PRE5555, 29 cm x 28 cm, 5 Pk

3M Stock
B5005265124
UPC
00849554007949



3M™ Kerralite Cool™ Moisture Balancing Hydrogel Dressing



3M™ Attest™ VH₂O₂ Tri-Metric Chemical Indicators



3M™ Attest™ Rapid Ethylene Oxide Biological Indicator, 1294, Green Cap, 4 hr, 50/CAR, 4 CAR/CS, 200/CS

3M Stock
7000002715
Previous 3M Stock
70200704602
UPC
30707387470389

3M™ Medical Tape 1530MS, Microporous Rayon Nonwoven, Without Liner, 3 IN x 72 YD

3M Stock
7000053197
Previous 3M Stock
70200420621
UPC
00707387007652

3M™ Medipore™ H Soft Cloth Surgical Tape, 2860 Series



3M™ Bair Hugger™ Warming Blanket, 52301

3M Stock
B00042309

3M™ Bair Hugger™ Warming Blanket 31500, Multi-Access, 10/Case

3M Stock
B00042293
UPC
50707387790078

3M™ Bair Hugger™ Warming Gown with Booties 83001, Standard, 30/Case

3M Stock
B00042229
UPC
50707387774542



3M™ Avagard™ Foaming Instant Hand Antiseptic

3M Stock
CBGBLRUS1530
UPC
00051131223035

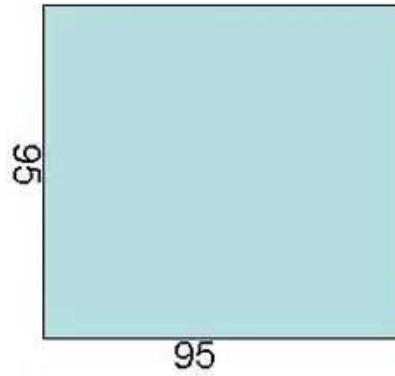

3M™ Steri-Drape™ Drape Sheet, 40 per Carton / 4 Cartons per Case, 9071

3M Stock
7000053867
Previous 3M Stock
70200757758
UPC
00707387581572

3M™ Steri-Drape™ (9069NS) 36" (90cm)

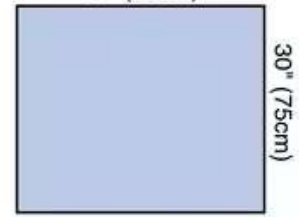

3M™ Steri-Drape™ Drape Sheet 9069NS, 36 IN x 30 IN, 300/CS

3M Stock
7000053589
Previous 3M Stock
70200687989
UPC
00707387456498



Nexcare™ DUO Bandages

3M Stock
CBGBLRUS1530
UPC
00051131223035



ACE™ Brand Compression Elbow Support

3M Stock
CBGBLRUS1525
UPC
00051131208957



FUTURO™ Back For Her Support, 95348ENR, Adjustable

3M Stock
CBGBLRUS1491
UPC
00051131212442



Nexcare™ Heel Blister Comfort Cushion CCH-04, 2 3/4 in x 1 3/4 in (7 cm x 4,5 cm)

3M Stock
 CBGBLRUS1469
 UPC
 00051141994956



ACE™ Brand Reusable Cold Compress

3M Stock
 COBBLW014209
 UPC
 00051131204003



ACE™ Brand Compression Knee Brace with Side Stabilizers

3M Stock
 COBBLW014195
 UPC
 00051131198234



ACE™ Contoured Back Support 205324, One Size Adjustable

3M Stock
 COBBLW014169
 UPC
 00051131221789



ACE™ Brand Adjustable Knee Support with Side Stabilizers

3M Stock
 COBBLW014122
 UPC
 00051131216594



ACE™ Brand Deluxe Ankle Stabilizer

3M Stock
 COBBLW014072
 UPC
 00051131226210



Nexcare™ Skin Crack Care,
112, 0.24 fl. oz. Bottle

3M Stock
COBBLW014036
UPC
00051131861015



Nexcare™ Flexible Fabric
Bandages 665-30PB, 30 ct

3M Stock
COBBLW014021
UPC
00051131995222



FUTURO™ Comfort Stabilizing
Back Support, 46820ENR,
Adjustable

3M Stock
CBGBLW011058
UPC
00051131196919



FUTURO™ Comfort Stabilizing
Wrist Brace

3M Stock
CBGBLW011033
UPC
00051131196773



FUTURO™ Stirrup Ankle Brace,
48442EN, Adjustable

3M Stock
CBGBLW011009
UPC
00051131200807



3M™ Steri-Drape™ Shoulder
Split Sheet with Pouch 9196NS,
90 IN x 102 IN, 25/CS

3M Stock
7000053710
Previous 3M Stock
70200738220
UPC
00707387561307

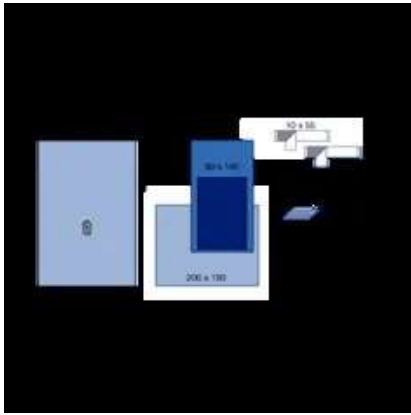

3M™ Steri-Drape™ Foot / Hand Pack, 7 per Carton / 2 Cartons per Case, 9054P

3M Stock
7000053779
Previous 3M Stock
70200748427
UPC
00707387568078



Universal Adapter



3M™ Red Dot™ Repositionable Monitoring Electrode, 2600 Series



3M™ Medical Tape, 4578, Polyester Spunlace Nonwoven Extended Wear, Configurable

3M Stock
7100301144
Previous 3M Stock
70000128507



3M™ Bair Hugger™ Animal Health Overbody Blanket



3M™ Steri-Strip™ Elastic Skin Closures

3M Stock
B00036232



3M™ Tegaderm™ Antimicrobial
I.V. Advanced Securement
Dressing 9132



3M™ Scotchcast™ Quick Step
Double Sided Felt Roll Splint



Gamgee Highly Absorbent
Padding

3M Stock
B00035315

UPC
50051115052748



ACE™ Shoulder Hot/Cold Wrap
208612, One Size - Adjustable

3M Stock
CBGBLRUS1532

UPC
00051131221680



3M™ Touchless Care™
Antifungal Spray, 82402

3M Stock
B5005265201



SENSAT.R.A.C.™ Pad,
M8275057/10, 10/pk

3M Stock
B5005265161

UPC
00849554002531



3M™ V.A.C.® Granufoam
Silver™ Dressing



3M™ Prevena Restor™
BellaForm™ Dressing



3M™ Kerramax Care™ Super-
Absorbent Dressing



ACTISORB™ Silver 220
Dressing



ACE™ Reusable Cold/Hot Pack
with Compression Wrap 207519

3M Stock
COBBLW014210
UPC
00051131203983

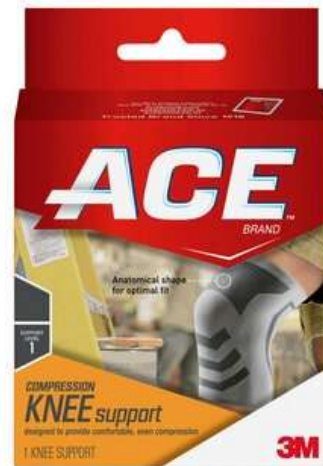

ACE™ Brand Compression
Knee Support

3M Stock
COBBLW014196
UPC
00051131212183



ACE™ Brand Energizing Hand Support

3M Stock
COBBLW014183

UPC
00051131198401



ACE™ Brand Adjustable Hinged Knee Brace

3M Stock
COBBLW014130

UPC
00051131200029



ACE™ Brand Contoured Back Support

3M Stock
COBBLW014083

UPC
00051131208919



Nexcare™ Soft & Stretch Tape 751, 1 in x 216 in (25,4 mm x 5,48 m)

3M Stock
COBBLW014037

UPC
00051131667778



Nexcare™ Blister Waterproof Bandages BWB-06, 1 1/16 in x 2 1/4 in

3M Stock
COBBLW014007

UPC
00051131208704



FUTURO™ Cervical Collar, 09027ENR, Adjustable

3M Stock
CBGBLW011059

UPC
00051131201361



**FUTURO™ Ultra Performance
Knee Stabilizer**

3M Stock
CBGBLW011047

UPC
00051131201477



**FUTURO™ Wrap Around Ankle
Support**

3M Stock
CBGBLW011010

UPC
00051131200791



**3M™ Tegaderm™ Antimicrobial
Transparent Dressing 9124**



**3M™ Scotchpak™ Polyester
Backing Film Laminate, 9727,
Configurable Roll**

3M Stock
7100187916

Previous 3M Stock
70000065683

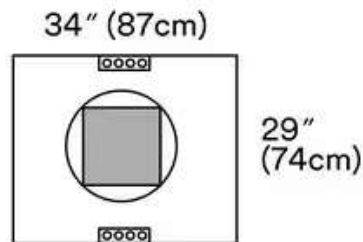

**3M™ Steri-Drape™ Pouch with
loban™ 2 Incise Film, 2057, 87
cm x 74 cm, 10/Carton, 4/Case**

3M Stock
7000030146

Previous 3M Stock
70200624800

UPC
30707387092871

Alternative ID
2057



**3M™ Ranger™ Irrigation Fluid
Warming Unit, 24700, 120V-
ENG-B, 1 Each**

3M Stock
7100236198

Previous 3M Stock
70201801738

UPC
00707387803148



**3M™ Curoso Jet™ Disinfecting
Cap for Needleless Connectors,
CFJ Series**



**3M™ Curoso™ Stopper
Disinfecting Cap for Open
Female Luers, CS Series**



**3M™ Bair Hugger™ Pediatric
Warming Gown 81501, 20/Case**

3M Stock
B10252967

UPC
00707387789961



**3M™ Medical Tape 1529, Single
Sided Microporous Rayon
Nonwoven Fabric, 83# Liner,
CONFIGURABLE**

3M Stock
7100012624

Previous 3M Stock
70000015134



**3M™ Medical Tape 9830, Single
Sided Transparent Polyethylene,
63# Liner, Configurable**

3M Stock
7100012408

Previous 3M Stock
70000039167

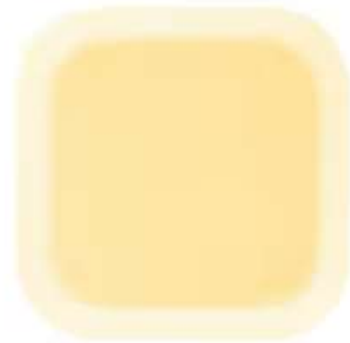

**3M™ Nu-Derm™ Border
Hydrocolloid Dressing**

3M Stock
B5005265212



ACTIV.A.C.™ Carrying Case

3M Stock
B5005265185

**3M™ V.A.C. Whitefoam™
Dressings, Family product
image**



**3M™ V.A.C.® Whitefoam™
Dressing**

3M Stock
B5005265135

**3M™ Prevena Restor™
ArthroForm™ Incision
Management System**



**3M™ V.A.C.® Granufoam™
Dressing w/SensaT.R.A.C.™
Pad**

3M Stock
B5005265111



**3M™ Medical Tape 9948, Single
Sided Thermoplastic Elastomer,
63# liner, Configurable**

3M Stock
7100000223
Previous 3M Stock
70000126170



**3M™ Kerracel™ Gelling Fiber
Dressing**



**3M™ Littmann® Stethoscope
Floating Diaphragms,
CARDIOLOGY III,
W/SURROUND, Gray**

3M Stock
7100119175

Previous 3M Stock
78807869801

UPC
00707387783464



**3M™ Littmann® Stethoscope
Floating Diaphragms,
CARDIOLOGY III,
W/SURROUND, Black**

3M Stock
7100119139

Previous 3M Stock
78807839853

UPC
00707387783471

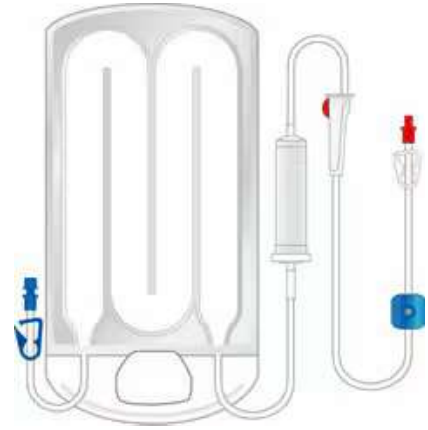

**3M™ Ranger™ Blood/Fluid
Warming Set, 24000 Series**



**3M™ Attest™ Rapid Steam
Biological Indicator Test Pack
with Type 5 CI, 41382**



**3M™ Medical Tape 9834, Single
Sided Polyurethane, 78# Carrier,
CONFIGURABLE**

3M Stock
7100013562

Previous 3M Stock
70000127418



**3M Scotchpak™ 9723 Backing
Tan Polyester Film Laminate**

3M Stock
70000064561



3M™ Bair Hugger™ Warming Blanket, 422xx



3M™ Bair Hugger™ + Warming Gown Kit



3M™ Bair Hugger™ Flex Warming Gown



3M™ Skin and Nasal Antiseptic, 192401

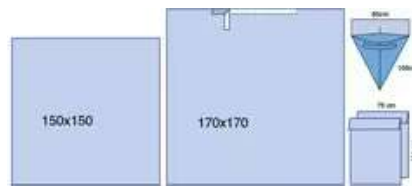

3M™ Steri-Drape™ Lithotomy Pack with Pouch, 7 per Carton / 2 Cartons per Case, 9106

3M Stock

7000053863

Previous 3M Stock

70200757717

UPC

00707387581534

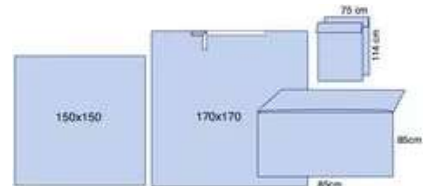

3M™ Steri-Drape™ Lithotomy Pack with Under Buttocks Drape, 7 per Carton / 2 Cartons per Case, 9105

3M Stock

7000053862

Previous 3M Stock

70200757709

UPC

00707387581527



3M™ Medical Tape 9860, Single Sided Polyester, 63# liner, Configurable

3M Stock
7100070637

Previous 3M Stock
70000065584



3M™ CoTran™ Melt-blown Polyurethane Nonwoven Backing Film, 9700, Configurable

3M Stock
7100045177

Previous 3M Stock
70000126014



3M™ Bair Hugger™ Warming Blanket 53700, Small Lower Body, 10/Case

3M Stock
B00042314

UPC
50707387790115



3M™ Bair Hugger™ Warming Blanket, 425xx



3M™ Bair Hugger™ Flex Warming Gown with Booties 83003, Standard, 30/Case

3M Stock
B00042233

UPC
50707387774443



3M™ Bair Hugger™ Booties

3M™ Steri-Drape™ (1081)



Overall Size
Length - 64" (164cm)

3M™ Steri-Drape™ (1081)



Overall Size
Length - 64" (164cm)

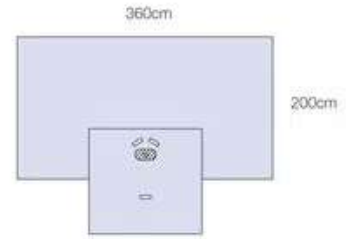

3M™ Steri-Drape™ TUR Pack,
7 per Carton / 2 Cartons per
Case, 1081PD

3M Stock
7000053875

Previous 3M Stock
70200758764

UPC
00707387582234

3M™ Steri-Drape™ TUR Pack
1081P, 7 per Carton / 2 Cartons
per Case

3M Stock
7000030258

Previous 3M Stock
70200742263

UPC
00707387563288

3M™ Steri-Drape™ Hand
Drape, 20 per Case, 9052NS

3M Stock
7000053708

Previous 3M Stock
70200738170

UPC
00707387561253



Stethoscope Identification Tag



3M™ Red Dot™ ECG
Monitoring Electrodes, 2231, 2.2
inch x 2 inch (5,1cm x 5,5cm),
50 ea/Bag, 20 Bag/Case

3M Stock
B00037603

UPC
00707387788865

3M™ Steri-Drape™ Orthopaedic
Surgical Pack 9012A

3M Stock
7000002782

Previous 3M Stock
70200737297

UPC
30707387560493

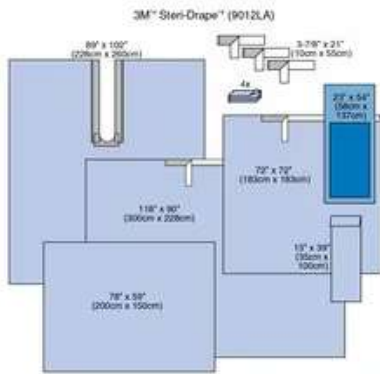

3M™ Steri-Drape™ Orthopaedic Pack 9012L, 4 per Carton / 2 Cartons per Case

3M Stock
7000030211

Previous 3M Stock
70200720442

UPC
50707387507522

3M™ Steri-Drape™ Orthopaedic Surgical Pack, 9051, 183 cm x 315 cm, 15/ Carton, 2/Case

3M Stock
700002778

Previous 3M Stock
70200737230

UPC
30707387560431

3M™ Steri-Drape™ Orthopaedic Surgical Pack 9012, 5 per Carton / 2 Cartons per Case

3M Stock
7000030181

UPC
50707387456004

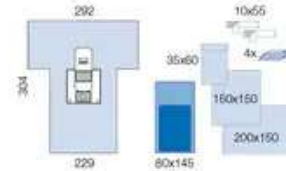
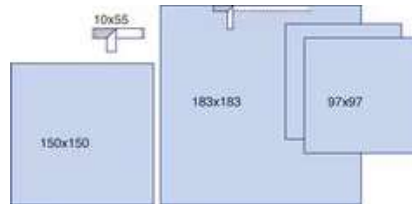
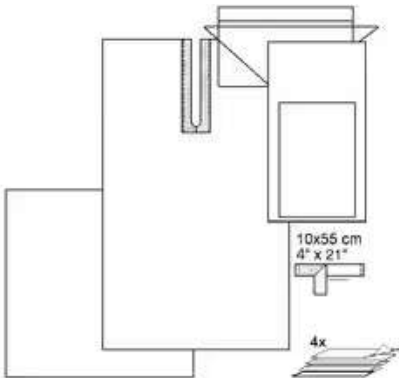

3M™ Steri-Drape™ Head and Neck Pack 9008, 7 per Carton / 2 Cartons per Case

3M Stock
7000030238

Previous 3M Stock
70200738238

UPC
30707387561148

3M™ Steri-Drape™ Head and Neck Pack, 10 per Carton / 2 Cartons per Case, 9009

3M Stock
7000053866

Previous 3M Stock
70200757741

UPC
00707387581565

3M™ Steri-Drape™ Arthroscopy Pack, 4 per Carton / 2 Cartons per Case, 1194P

3M Stock
7000053776

Previous 3M Stock
70200748393

UPC
00707387568047

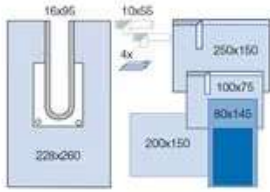

3M™ Steri-Drape™ Shoulder Arthroscopy Pack, 5 per Carton / 2 Cartons per Case, 9196P

3M Stock
7000053777
Previous 3M Stock
70200748401
UPC
00707387568054



3M™ Littmann® Master Cardiology™ Stethoscope



3M™ Littmann® Classic II Infant Stethoscope



3M™ Tegaderm™ Silicone Border Foam Dressing



3M™ Scotchpak™ Release Liner Fluorosilicone Coated Polyester Film, 9709, Config Roll

3M Stock
7100119905
Previous 3M Stock
70000203425



ACE™ Sports Tape 207464, 4 pack, 1.5 in x 360 in (10 yd) in (3.81 cm x 9.14 m) White Tape

3M Stock
70007042248
UPC
00051131208117



ACE™ Tape 207465, 1 pack, 1.5 in x 10 yds

3M Stock
70005175222

UPC
00051131208162



ACE™ Sports Tape, White, Bulk Pack 909010

3M Stock
70005295350

UPC
00051131209497



3M™ Littmann® Classic III™ Stethoscope



3M™ Steri-Strip™ Blend Tone Skin Closures



3M™ Tegaderm™ Absorbent Clear Acrylic Dressing, 90800 Series



3M™ Tegaderm™ HP Transparent Film Dressing Frame Style



**3M™ Medical Release Liner
9955, Polypropylene,
Fluoropolymer, Configurable**

3M Stock
7100127453
Previous 3M Stock
70000127640



**ACE™ Sport Deluxe Ankle
Stabilizer, 901008, Adjustable**

3M Stock
70007009528
UPC
00051131208834



**3M™ CoTran™ Ethylene Vinyl
Acetate Membrane, 9728,
Config Roll**

3M Stock
7100000167
Previous 3M Stock
70000065592



**3M™ Steri-Drape™ ENT
Surgical Pack, 8 per Carton / 2
Cartons per Case, 9007**

3M Stock
7000053565
Previous 3M Stock
70200687443
UPC
50707387455984



**3M™ Attest™ Biological
Indicator Incubator for steam,
116**

3M Stock
B00014256
UPC
00707387094980



**3M™ Attest™ Super Rapid
Steam Biological Indicator
Challenge Pack, 1496V**



3M™ Bair Hugger™ Warming Blanket 52500, Lower Body, 10/Case

3M Stock
B00042310

UPC
50707387790092



3M™ Bair Hugger™ Warming Blanket, 400xx



3M™ Bair Hugger™ Warming Blanket, 30500

3M Stock
B00042287

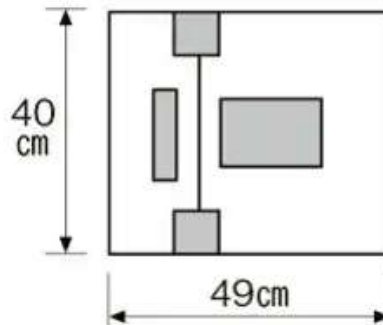
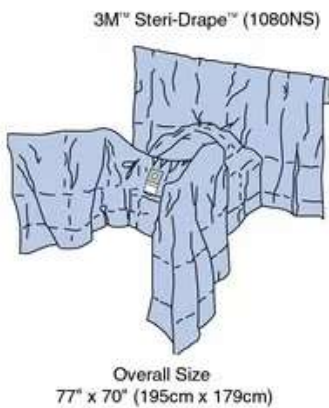

3M™ Steri-Drape™ (1021NS)
15" (40cm)
15" (40cm)

3M™ Steri-Drape™ Gynaecological Drape with Pouch 1080NS, 77 IN x 70 IN, aperture 4 1/2 IN x 3 1/2 IN, 30/CS

3M Stock
7000053702

Previous 3M Stock
70200737164

UPC
00707387560126

3M™ Steri-Drape™ Small Drape with Incise Film and Pouch 1023, 10/Carton 4 Carton/Case

3M Stock
700002790

Previous 3M Stock
70200738493

UPC
50707387446036

Alternative ID
1023

3M™ Steri-Drape™ Small Drape with Incise Film 1021NS Non-Sterile, 200/CS

3M Stock
7000053459

Previous 3M Stock
70200542457

UPC
00707387072803

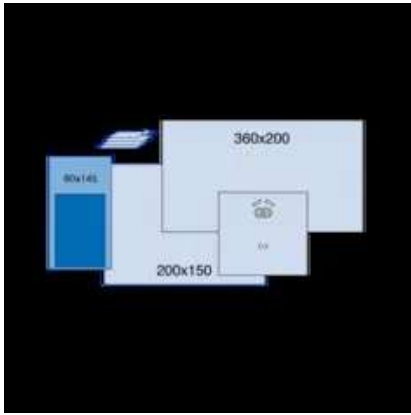

3M™ Steri-Drape™ Hand Pack 9015, 7 per Carton / 2 Cartons per Case

3M Stock
7000030253

Previous 3M Stock
70200741588

UPC
00707387562694



3M™ Diaphoretic Foam Monitoring Electrode, 2200 Series

3M Stock
B00037601



3M™ Steri-Strip™ Antimicrobial Skin Closures A1847, 1/2 inch x 4 inches (12mm x 100mm), 6 Strips/Envelope 50/Case 4 Car...

3M Stock
B00036185

UPC
30707387472987



3M™ Tegaderm™ High Performance Foam Adhesive Dressing



3M™ Ranger™ Blood/Fluid Warming Standard Flow Set, 24240, 10/Case

3M Stock
7100239281

Previous 3M Stock
70200793233

UPC
50707387805000



3M™ Coban™ Self-Adherent Wrap with Latex



FUTURO™ Comfort Fit Knee Support, 04039ENR, Adjustable

3M Stock
70007070454
UPC
00051131224605



Futuro™ Comfort Fit Knee Stabilizer Adjustable 04040ENR

3M Stock
70007070447
UPC
00051131224599



Vetrap Bandaging Tape

3M Stock
B00003186
UPC
04064035091910



Nexcare™ Strong Hold Pain-Free Removal Tape SST-1, 1 in x 4 yd (25,4 mm x 3,65 m)

3M Stock
CBGBLRUS1515
UPC
00051131216785



Nexcare™ Max Hold Waterproof Bandages, Assorted

3M Stock
CBGBLRUS1509
UPC
00051131216778



ACE™ Brand Therapeutic Arch Support

3M Stock
CBGBLWUS1366
UPC
00051131216372



ACE™ Reusable Cold/Hot Compress 207518

3M Stock
COBBLW014211
UPC
00051131203990



ACE™ Brand Moisture Control Knee Support

3M Stock
COBBLW014197
UPC
00051131197855



ACE™ Brand Night Wrist Sleep Support

3M Stock
COBBLW014184
UPC
00051131225992



ACE™ Knee/Elbow Pads, 908002, One Size

3M Stock
COBBLW014145
UPC
00051131209220

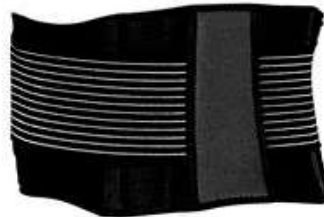

ACE™ Brand Adjustable Back Brace

3M Stock
COBBLW014084
UPC
00051131208100



Nexcare™ Ultra Stretch Adhesive Pad SFP34, 3 in x 4 in

3M Stock
COBBLW014038
UPC
00051131197749



FUTURO™ Thumb Deluxe Stabilizer

3M Stock
CBGBLW011060
UPC
00051131198555



FUTURO™ Comfort Knee Support, 76587ENR, Medium

3M Stock
CBGBLW011048
UPC
00051131200999



FUTURO™ Comfort Stabilizing Back Support

3M Stock
CBGBLW011036
UPC
00051131201552



FUTURO™ Arm Sling, 46204ENR, Adult size

3M Stock
CBGBLW011011
UPC
00051131200920



ACE™ Open Knee Support

3M Stock
CBGBLRUS1540
UPC
00051131199910



Nexcare™ Duo Adhesive Gauze Pads DSA34-4, 3 in x 4 in (76 mm x 101 mm), 4/pk

3M Stock
CBGBLRUS1537
UPC
00051131225404



FUTURO™ Posture Corrector,
One Size - Adjustable

3M Stock
CBGBLRUS1520
UPC
00051131221871



Nexcare™ Strong Hold Pain-Free
Removal Bandages

3M Stock
CBGBLRUS1510
UPC
00051131193574



ACE™ Brand Carpal Tunnel
Wrist Stabilizer, One Size

3M Stock
CBGBLRUS1506
UPC
00051131221796



ACE™ Brand Compression
Elbow Sleeve with Pad

3M Stock
CBGBLRUS1495
UPC
00051131194175



ACE™ Brand Elastic Bandages

3M Stock
COBBLW014201
UPC
00051131208148



ACE™ Brand Wrap Around
Wrist Support

3M Stock
COBBLW014187
UPC
00051131203853



ACE™ Brand Elasto-Preene™ Elbow Support

3M Stock
COBBLW014174
UPC
00051131203921



ACE™ Brand Ankle Brace with Side Stabilizers

3M Stock
COBBLW014162
UPC
00051131203914



ACE™ Brand Adjustable Elbow Support

3M Stock
COBBLW014096
UPC
00051131208971



Nexcare™ No Hurt Wrap

3M Stock
COBBLW014027
UPC
00051131668751



FUTURO™ Therapeutic Arch Support, 48510EN, Adjustable

3M Stock
CBGBLW011074
UPC
00051131211407



FUTURO™ For Her Knee Support

3M Stock
CBGBLW011051
UPC
00051131190030



FUTURO™ Night Plantar Fasciitis Sleep Support

3M Stock
CBGBLW011002
UPC
00051131201613



Nexcare™ Athletic Wrap

3M Stock
CBGBLRUS1507
UPC
00051131666863



ACE™ Brand Deluxe Back Stabilizer, Adjustable

3M Stock
CBGBLRUS1493
UPC
00051131205017



ACE™ Brand Elastic Bandage with Hook Closure

3M Stock
COBBLW014200
UPC
00051131203655

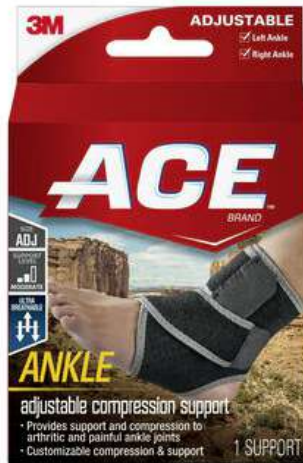

ACE™ Ankle Support 207248, Adjustable

3M Stock
COBBLW014161
UPC
00051131198067



ACE™ Brand Elbow Strap

3M Stock
COBBLW014095
UPC
00051131199927

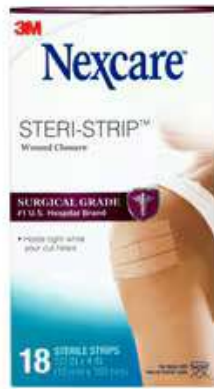

Nexcare™ Steri-Strip™ Wound Closure

3M Stock
COBBLW014040
UPC
00051131641242



FUTURO™ Performance Comfort Knee Support

3M Stock
CBGBLW011050
UPC
00051131200647



FUTURO™ Compression Glove

3M Stock
CBGBLW011038
UPC
00051131200401



FUTURO™ Comfort Ankle Support

3M Stock
CBGBLW011000
UPC
00051131201033



ACE™ Brand Deluxe Thumb Stabilizer, Adjustable, Black, 1/Pack

3M Stock
CBGBLWUS1367
UPC
00051131216419



ACE™ Brand Work Belt

3M Stock
COBBLW014172
UPC
00051131204232



ACE™ Brand Sports Underwrap

3M Stock
COBBLW014157
UPC
00051131222618



ACE™ Brand Self-Adhering Bandage

3M Stock
COBBLW014088
UPC
00051131203709



Nexcare™ Ultra Stretch Bandages

3M Stock
COBBLW014039
UPC
00051131995260



Nexcare™ No Sting Liquid Bandage, .61 Fl oz

3M Stock
COBBLW014024
UPC
00051131225398

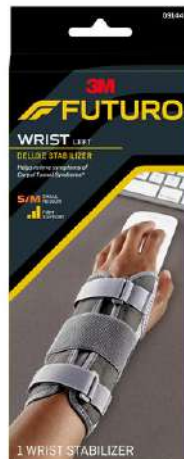

FUTURO™ Deluxe Wrist Stabilizer

3M Stock
CBGBLW011037
UPC
00051131200906



FUTURO™ Abdominal Compression Support

3M Stock
CBGBLW011012
UPC
00051131200944



3M™ Medical Transfer Adhesive
1504XL, High Tack, 6 IN x 600
YD, 62# Liner, inc 1/16 IN ext
liner each side, 1 roll/case

3M Stock
7100148824

Previous 3M Stock
70201175422

UPC
00707387784645

3M™ Kerracel™ Ag Gelling
Fiber Dressing, CWL1158, 4 in x
5 in (10 cm x 12.5 cm), 10/ct,
10ct/Case

3M Stock
7100253239

Previous 3M Stock
70001701351

UPC
04054596954366

3M™ Steri-Vac™
Sterilizer/Aerator, GS Series



3M™ Stainless Steel Basket for
Sterilization Equipment

3M™ Steri-Gas™ EO Gas
Cartridges, 8-170

3M Stock
B00042769

UPC
50707387495539

3M™ Medical Tape, 9907



3M™ Steri-Drape™
Cardiovascular Sheet with
Ioban™ 2 Incise Film



3M™ Attest™ Steam Load
Record Cards, 1243LR, 100
ea/case

3M Stock
B00042817

UPC
50707387785784



3M™ N-A™ ULTRA Knitted
Viscose Primary Dressing

3M Stock
B5005265103



3M™ Kerralite Cool™ Border
Moisture Balancing Hydrogel
Dressing



3M™ Medical Component, 9779,
Flexform Wire Tape



3M™ Steri-Drape™ Medium
Drape with Incise Film, 1060
Series



3M™ Defib Pads, 2340 Series



3M™ Pressure Infusor Off-Set
IV Pole



3M™ PRESS-ON™ Aspheric
Lens



3M™ Ioban™ Special Incise
Drape



3M™ Scotchpak™ Polyester
Backing Film Laminate, 9733, 7
in x 6000 ft

3M Stock
7010386240

Previous 3M Stock
70200751264



3M™ Steri-Drape™ Basic
Surgical Pack, 9000 Series



3M™ Steri-Drape™ Long
U-Drape, 1019



3M™ Steri-Drape™ Incise
Drape, 1000 Series



3M™ Precise™ Vista
Disposable Skin Stapler



3M™ Remover Lotion



3M™ Red Dot™ Trace Prep
2236, 3/4 inch x 196 inch
(18,1mm x 5m), Roll with
Dispenser, (36 Roll/Case)

3M Stock
B00037606
UPC
00707387000011



3M™ Kerramax Care™ Gentle
Border Dressing



3M™ Littmann® Stethoscope
Spare Parts Kit, Classic II S.E.



1413B 11X14 STANDARD BLUE
VETERINARY X-RAY FILM
100/INR, 5 INR/CV

3M Stock
70200729401
UPC
30051115052973



3M™ Blue Standard Veterinary
X-ray Film (Blue sensitive), 14" x
17"

3M Stock
70200729419
UPC
30051115052980



3M™ Green Standard Veterinary
X-ray Film, 10" x 12",1436G

3M Stock
70200743170
UPC
00051115053757



3M™ Green Standard Veterinary
X-ray Film, 14" x 17",1436G

3M Stock
70200743188
UPC
00051115053764



3M™ Blue Standard Veterinary
X-ray Film (Blue sensitive), 10" x
12"

3M Stock
70200729393
UPC
30051115052966



**3M™ Blue Standard Veterinary
X-ray Film (Blue sensitive), 8" x
10"**

3M Stock
70200729385

UPC
50051115052953



3M™ Steri-Drape™ Leggings



**3M™ Steri-Drape™ U-Drape,
1000 Series**



**3M™ Steri-Drape™ Tube
Organizer**



**3M™ Asymetrix™ Detail
Hardback Cassettes (No
window), 8" x 10"**

3M Stock
70200731332

UPC
00051115053238



**3M™ Asymetrix™ Detail
Hardback Cassettes (No
window), 10" x 12"**

3M Stock
70200736679

UPC
00051115053498



**3M™ Asymetrix™ Detail
Hardback Cassettes (No
window), 14" x 17"**

3M Stock
70200736976

UPC
00051115053511



**3M™ Asymetrix™ Detail
Hardback Cassettes (No
window), 11" x 14"**

3M Stock
70200736687

UPC
00051115053504



3M™ Medical Tape, 9836



**3M™ Scotchpak™
Fluoropolymer Coated
Polypropylene Release Liner,
9741, 10 in x 1900 yd**

3M Stock
7010413754

Previous 3M Stock
70200740697



**3M™ Avagard™ Wall Bracket
and Foot Pump**



**3M™ Steri-Drape™ Operation
Tape**



3M™ Steri-Drape™ Isolation
Drape with Ioban™ 2 Incise Film
and Pouch, 6610 Series



3M™ Steri-Drape™ Arthroscopy
Sheet with Pouch, 1194



3M™ Precise™ Multi-Shot
Disposable Skin Stapler



3M™ Littmann® Stethoscope
Spare Parts Kit, Snap Tight Soft-
Sealing Eartips



3M™ Red Dot™ Monitoring
Electrode with 3M™
Micropore™ Tape Backing, 2200
Series



BIOSORB™ Gelling Fibre
Dressing BGF0505U, 5 cm x 5
cm, 10 ea/bx

3M Stock
B5005265096

UPC
15051978008422



TIELLE™ Lite Dressing,
MTL308, 8 cm x 15 cm, 10/Ct, 5
Cts/Cs

3M Stock
B5005265065

UPC
15051978000709

3M™ Mount

3M™ Medical Transfer
Adhesive, 1524



3M™ Medical Foam Tape, 1770
Series

3M™ Steri-Drape™ Adhesive
Aperture Drape, 9000 Series

3M™ Steri-Drape™ Isolation
Drape, 1010 Series



3M™ Steri-Drape™ Roll Prep
Drape, 1000



3M™ Medical Tape, 1509



3M™ Curox Tips™ Disinfecting
Cap for Male Luers, CM5-200



3M™ Littmann® Stethoscope
Spare Parts Kit, Lightweight II
S.E.



3M™ Steri-Drape™ Instrument
Pouch



3M™ Steri-Drape™ Large Towel
Drape, 1010



3M™ Scotchpak™ Release
Liner, 1022



3M™ Littmann® Stethoscope
Spare Parts Kit, Classic III™,
Cardiology IV™ and CORE



3M™ Tegaderm™ Transparent
Dressing Frame Style with
Border



3M™ PRESS-ON™ Prism,
90-10000 Series



3M™ DuraPrep™ Surgical
Solution



3M™ Steri-Drape™ Large
Ophthalmic Sheet with Aperture
and 2 Pouches, 1065B,
14/Carton 2 Carton/Case

3M Stock
B00040143

UPC
50707387807486



3M™ Steri-Drape™ Small Towel
Drape, 1000



3M™ Steri-Drape™ Caesarean-
Section Drape with Incise
Pouch, 7960 Series



Telemetry Adapter



3M™ Scotchpak™ Polyester
Packaging Film Laminate, LF
Series



FUTURO™ Custom Pressure
Strap 45980ENR, Adjustable

3M Stock
CBGBLW011031

UPC
00051131199156



3M™ Medical Silicone Tape,
2477



3M™ Steam Sterilization Record
Envelopes, 1254E



3M™ Scotchpak™ Polyester
Packaging Film Laminate, PF
Series



3M™ Littmann® Stethoscope
Spare Parts Kit, Master
Cardiology™



3M™ Medical Tape, 1538



3M™ Cavilon™ Extra Dry Skin
Cream 3386

3M Stock
B00042115

UPC
50707387447026



3M™ Universal Electrosurgical
Plate



3M™ Steri-Drape™ Wound
Edge Protector, 1070 Series



3M™ Steri-Drape™ Caesarean-
Section Sheet with Aperture
Pouch, 7960 Series



Nexcare™ Cold/Hot Pack
2671PEG, 4 in x 10 in

3M Stock
COBBLW014035

UPC
00051131666887



3M™ Micropore™ Tan Surgical
Tape, 1533 Series



3M™ Medical Tape, 1522



3M™ LEAP™ III Pad



3M™ Universal Electrosurgical Pad



3M™ Steri-Drape™ Refractive Drape For LASIK, 1022



3M™ Steri-Drape™ Adhesive Towel Drape



3M™ Tegaderm™ Hydrocolloid Thin Dressing



3M™ Bair Hugger™ 800 Series Warming Unit Temperature Test Kit, 90055, Model 875, 1 Each

3M Stock
B5005108084

UPC
00707387804442



3M™ Replacement Filter



3M™ Bair Hugger™ 500/700
Series Warming Unit
Temperature Test Kit, 22110, 1
Each

3M Stock
B5005108076

UPC
00707387804459



3M™ Steri-Drape™ Fluoroscope
Drape



3M™ Steri-Drape™ Isolation
Bag, 1003



3M™ Scotchpak™ Polyester
Backing Film Laminate, 9730,
Config Roll

3M Stock
7100009967

Previous 3M Stock
70000201544



3M™ Medical Component, 9818,
Flexfoam Closures



3M™ Steri-Drape™ Pouch with
Ioban™ 2 Incise Film, 6600
Series



3M™ Steri-Drape™ Irrigation Pouch, 1000 Series



3M™ Steri-Drape™ X-ray Image Intensifier (C-Arm) Drape, 1013



3M™ Steri-Drape™ Small Drape with Adhesive Aperture, 1000 Series



3M™ Medical Loop Fastener, 7330



3M™ Littmann® Stethoscope Spare Parts Kit, Master Classic™



3M™ Steri-Drape™ Aperture Pouch Drape, 1000 Series



3M™ Steri-Drape™ TUR Drape,
1081

3M™ Tegaderm™ Non-Adherent
Contact Layer

3M™ Reusable Cold/Hot Pack,
1570 Series

3M™ Asymetrix™ Detail Hardback Cassettes (No window), 11" x 14"

3M ID 70200736687 UPC 00051115053504

Typical properties

Factory ISO Certification: No ISO Certification information available
eClass 14 Classification Group: 34260500

3M™ Asymetrix™ Detail Hardback Cassettes (No window), 14" x 17"

3M ID 70200736976 UPC 00051115053511

Typical properties

Factory ISO Certification: No ISO Certification information available
eClass 14 Classification Group: 34260500

3M™ Asymetrix™ Detail Hardback Cassettes (No window), 10" x 12"

3M ID 70200736679 UPC 00051115053498

Details

Designed for slower, detail radiography
Hardback Cassettes with no window
Size : 10 in x 12 in
Available in other sizes as well

Typical properties

Factory ISO Certification: No ISO Certification information available
eClass 14 Classification Group: 34260500

3M™ Asymetrix™ Detail Hardback Cassettes (No window), 8" x 10"

3M ID 70200731332 UPC 00051115053238

Details

Designed for faster radiography with detail

Equine: Recommended for non-High Frequency portable x-ray machines

Increased diagnostic ability

Size: 8" x 10 "

Typical properties

Factory ISO Certification: No ISO Certification information available

eClass 14 Classification Group: 34260500

3M™ Tegaderm™ Non-Adherent Contact Layer

Details

- Minimizes disruption of granulating tissue
- Lessens patient pain during dressing changes and removal
- Maintains an optimal moist wound environment for healing
- Indicated for both partial and full thickness wounds
- Easily cut to size

Typical properties

- Brands: Tegaderm™
- Dressing Type: Contact Layer
- Factory ISO Certification: No ISO Certification information available
- eClass 14 Classification Group: 34210402

Dimensions and Classifications

- Overall Length (Imperial): 3 in, 8 in
- Overall Length (Metric): 7.5 cm, 7.62 cm, 20 cm
- Overall Width (Imperial): 4 in, 8 in, 10 in
- Overall Width (Metric): 10 cm, 20.32 cm, 25 cm

3M™ Steri-Drape™ Tube Organizer

Typical properties

Accessories: Miscellaneous
Cladimed Code: E51BA99
Factory ISO Certification: No ISO Certification information available
Material: Plastic
Model: 1115
Procedure: General Surgery
Product Color: Transparent
Product Type: Tube Organizer
Product Type Free Format: Drape
Product Use: Accessory
Sterile: Yes
Therapeutic Area and Conditions: All Surgeries
Units per Pack: 100

Dimensions and Classifications

Overall Length (Imperial): 5 in
Overall Length (Metric): 13.3 cm
Overall Width (Imperial): 2 in
Overall Width (Metric): 3.8 cm

3M™ Steri-Drape™ U-Drape, 1000 Series

Typical properties

Accessories: Bags and Pouches, Miscellaneous
Additional Drapes: Sheet
Cladimed Code: E51BA99,E51CD01
Factory ISO Certification: No ISO Certification information available
Loophole Length (Metric): 16 cm
Loophole Width (Metric): 49 cm
Material: Plastic
Model: 1015, 1015NSD, 1067
Procedure: Neurology, Orthopedic
Product Color: Transparent
Product Type: U-drape
Product Type Free Format: Drape
Product Use: Surgical Sheet
Sterile: No, Yes
Therapeutic Area and Conditions: Orthopaedic
Units per Pack: 5 , 10

Dimensions and Classifications

Overall Length (Imperial): 35 in, 47 in, 51 in
Overall Length (Metric): 89 cm, 120 cm, 130 cm
Overall Width (Imperial): 30 in, 47 in, 51 in
Overall Width (Metric): 76 cm, 119 cm, 130 cm

3M™ Steri-Drape™ Leggings

Typical properties

Accessories: Leggings

Additional Drapes: Pack

Cladimed Code: E51CA01,E51DA05

Factory ISO Certification: No ISO Certification information available

Model: 9040

Product Color: Blue

Product Type: Hip Drape, Utility Drape

Product Type Free Format: Drape

Product Use: General Surgery, Gynecology

Therapeutic Area and Conditions: Day Surgery, General Surgery, Obstetrics and Gynaecology, Urology

Units per Pack: 8 , 12

Dimensions and Classifications

Overall Length (Imperial): 44 in

Overall Length (Metric): 86 cm, 100 cm, 114 cm

Overall Width (Imperial): 29 in

Overall Width (Metric): 35 cm, 75 cm, 130 cm

3M™ Littmann® Stethoscope Spare Parts Kit, Classic II S.E.

Typical properties

Brands: Littmann®

Cladimed Code: K50BE02

Diaphragm Diameter (Imperial): 1.75 in

Diaphragm Diameter (Metric): 4.4 cm

Factory ISO Certification: No ISO Certification information available

Kit Includes: Nonchill Bell Sleeve, Snap Tight Soft-Sealing Eartips - Small, Tunable Rim/Diaphragm Assembly - Adult

Model: Classic II S.E.

Product Color: Black, Gray

Product Type: Spare Parts Kit

Units per Pack: 10

eClass 14 Classification Group: 34340191

3M™ Stainless Steel Basket for Sterilization Equipment

Typical properties

Accessory Type: Basket

Brands: Steri-Vac™

Catalog Number: 7880556039,7880785399

Factory ISO Certification: No ISO Certification information available

Industries: Life Sciences

Life Science Sterilization: Ethylene Oxide Low Temperature Sterilization

Product Type: Accessory

eClass 14 Classification Group: 34419090

3M™ Remover Lotion

Typical properties

Antiseptic Agent: CHG/IPA

Application: Remover Lotion

Brands: 3M™

Factory ISO Certification: No ISO Certification information available

Model: 8610

Product Type: Lotion

Product Use: Surgical

eClass 14 Classification Group: 34210190

3M™ Steri-Drape™ Small Drape with Adhesive Aperture, 1000 Series

Typical properties

Accessories: Aperture, Bags and Pouches
Cladimed Code: E51BA99,E51BD01
Factory ISO Certification: No ISO Certification information available
Loophole Length (Metric): 3.8 cm, 6.3 cm
Loophole Width (Metric): 6.3 cm
Material: Fabric, Plastic
Model: 1020, 1024, 1092
Procedure: EENT, General Surgery, Urology
Product Color: Blue, Transparent
Product Type: Aperture Drape, Aperture Pouch Drape
Product Type Free Format: Drape
Product Use: EENT, Surgical Sheet
Sterile: No, Yes
Therapeutic Area and Conditions: General Surgery, Ophthalmic
Units per Pack: 10 , 25 , 200

Dimensions and Classifications

Overall Length (Imperial): 15 in, 22 in
Overall Length (Metric): 40 cm, 57 cm
Overall Width (Imperial): 15 in, 19 in, 25 in
Overall Width (Metric): 40 cm, 49 cm, 66 cm

3M™ Steri-Drape™ Isolation Bag, 1003

Typical properties

Accessories: Bags and Pouches
Brands: Steri-Drape™
Cladimed Code: E51CE01
Factory ISO Certification: No ISO Certification information available
Material: Plastic
Model: 1003
Procedure: General Surgery
Product Color: Transparent
Product Type: Isolation Bag
Product Type Free Format: Drape
Product Use: Accessory
Therapeutic Area and Conditions: General Surgery
Units per Pack: 10

Dimensions and Classifications

Overall Length (Imperial): 20 in
Overall Length (Metric): 50 cm
Overall Width (Imperial): 20 in
Overall Width (Metric): 50 cm

3M™ Steri-Drape™ X-ray Image Intensifier (C-Arm) Drape, 1013

Typical properties

Accessories: Miscellaneous
Additional Drapes: Equipment Drape
Cladimed Code: E51CE01
Factory ISO Certification: No ISO Certification information available
Material: Plastic
Model: 1013
Procedure: General Surgery
Product Color: Transparent
Product Type: Equipment Drape, X-ray Image Intensifier Drape
Product Type Free Format: Drape
Product Use: Equipment Drape
Sterile: Yes
Therapeutic Area and Conditions: Radiology
Units per Pack: 10

Dimensions and Classifications

Overall Length (Imperial): 64 in
Overall Length (Metric): 165 cm
Overall Width (Imperial): 41 in
Overall Width (Metric): 106 cm

3M™ Steri-Drape™ Irrigation Pouch, 1000 Series

Typical properties

Accessories: Bags and Pouches
Cladimed Code: E51CD01
Factory ISO Certification: No ISO Certification information available
Material: Plastic
Model: 1016
Procedure: Orthopedic
Product Color: Transparent
Product Type: Irrigation Pouch
Product Type Free Format: Drape
Product Use: Accessory
Sterile: Yes
Therapeutic Area and Conditions: General Surgery, Obstetrics and Gynaecology,
Orthopaedic, Urology
Units per Pack: 10

Dimensions and Classifications

Overall Length (Imperial): 19 in
Overall Length (Metric): 30 cm, 50 cm, 60 cm
Overall Width (Imperial): 23 in
Overall Width (Metric): 45 cm, 50 cm, 60 cm

3M™ Steri-Drape™ Fluoroscope Drape

Typical properties

Additional Drapes: Equipment Drape
Cladimed Code: E51DC01
Factory ISO Certification: No ISO Certification information available
Material: Plastic
Model: 1012
Procedure: General Surgery
Product Color: Transparent
Product Type: Fluoroscope Drape
Product Type Free Format: Drape
Product Use: Equipment Drape
Sterile: Yes
Therapeutic Area and Conditions: Radiology
Units per Pack: 10

Dimensions and Classifications

Overall Length (Imperial): 35 in
Overall Length (Metric): 90 cm, 110 cm
Overall Width (Imperial): 43 in
Overall Width (Metric): 90 cm, 110 cm

3M™ Steri-Drape™ Pouch with Ioban™ 2 Incise Film, 6600 Series

Typical properties

Accessories: Bags and Pouches

Cladimed Code: E51BA99,E51CD01

Factory ISO Certification: No ISO Certification information available

Features: Antimicrobial

Incise Area Length (Metric): 24 cm, 30 cm, 33 cm, 42 cm

Incise Area Width (Metric): 10 cm, 30 cm, 37 cm, 43 cm, 52 cm

Material: Fabric, Plastic

Model: 6657, 6658, 6659, 6687, 6697

Procedure: General Surgery, Neurology, Obstetrics and Gynaecology

Product Color: Transparent, Yellow

Product Type: C-section Sheet, Craniotomy Drape, Incise Drapes

Product Type Free Format: Drape

Product Use: Incise, Neurology Drape, Specialty Sheet

Therapeutic Area and Conditions: General Surgery, Obstetrics and Gynaecology

Units per Pack: 5 , 10

Dimensions and Classifications

Overall Length (Imperial): 29 in, 30 in, 35 in, 100 in, 160 in

Overall Length (Metric): 74 cm, 76 cm, 89 cm, 254 cm, 406 cm

Overall Width (Imperial): 30 in, 34 in, 77 in, 115 in

Overall Width (Metric): 76 cm, 87 cm, 196 cm, 292 cm

3M™ Medical Component, 9818, Flexfoam Closures

Typical properties

Adhesive Material: Acrylate
Adhesive Type: Acrylic/Acrylate (Tack)
Backing Caliper: 31 mil
Backing Caliper (Metric): 790 Micron
Backing Thickness (Imperial): 31 mil
Backing Thickness (Metric): 790 Micron
Brands: 3M™
Breathable: No
Conformability: High
Factory ISO Certification: No ISO Certification information available
Fluid Resistance Backing/Carrier: Yes
Liner Caliper (Metric): 120 Micron
Liner Caliper (mils): 4.9 mil
Liner Color: White
Liner Material: Paper
Liner Weight: 80.0 lb.
Liner Weight (Metric): 130 g/m²
Material: Polyolefin Foam
Maximum Length (Metric): 115 mm, 130 mm
Maximum Width Capacity: 0.34 in
Maximum Width Capacity (Metric): 10 mm
Printable Backing: No
Product Color: Tan, White
Product Type: Flexform Wire Closure
Product Usage: Formation
Tape Color: Tan, White
Tape Total Caliper: 40.0 mil
Tape Total Caliper (Metric): 1020.0 Micron
Tape Type: Closure

Dimensions and Classifications

Overall Length (Imperial): 4.5 in, 5.25 in
Overall Width (Imperial): 0.34 in

3M™ Scotchpak™ Polyester Backing Film Laminate, 9730, Config Roll

3M ID 7100009967

Details

Tan
Occlusive
Conformable
Controlled caliper

Typical properties

Backing (Carrier) Material: Polyester
Brands: Scotchpak™
Breathability: Occlusive
Caliper: 2.84 mils
Caliper (Metric): 72.1 µm
Catalog Number: 9730
Elongation CD: 50%
Elongation MD: 70%
Factory ISO Certification: No ISO Certification information available
Heat Seal: 7 lbs/in
Heat Seal (Metric): 31.1 N/25.4 mm
Heat Seal Layer: Ethylene Vinyl Acetate (EVA)
MVTR (g/m²/24 hr): 0.3
Oxygen Transmission (cc/m²/24hr): 2
Product Color: Tan
Product Type: Transdermal Backing
Sample Roll: 6 in x 25 yds
Sample Roll (Metric): 15 cm x 23 m
Tensile CD: 15 lbs/in
Tensile CD (Metric): 66.7 mm
Tensile MD: 12 lbs/in
Tensile MD (Metric): 53.4 mm
eClass 14 Classification Group: 41011103

Dimensions and Classifications

Overall Length (Imperial): 1500 yd
Overall Length (Metric): 1372 m
Overall Thickness (Imperial): 2.84 mil
Overall Thickness (Metric): 72.1 micron
Overall Width (Imperial): 40.157 in
Overall Width (Metric): 102 cm

3M™ Pressure Infusor Off-Set IV Pole

Typical properties

Brands: Ranger™
Cladimed Code: Non applicable
Clinical Area: ER, ICU, L&D, OR
Clinical Sub-Area: Obstetrics and Gynaecology
Contents: 5 wheels
Factory ISO Certification: No ISO Certification information available
Fluid Type: Blood/Fluid
Model: 90068, 90124
Net Weight (Imperial): 6.2 lb
Net Weight (Metric): 2800 g
Product Type: Pressure Infusor
Quantity: 1 each
Units per Pack: 1

Dimensions and Classifications

Overall Depth (Imperial): 1.75 in
Overall Depth (Metric): 40 mm
Overall Diameter (Imperial): 28 in
Overall Diameter (Metric): 71.1 cm
Overall Height (Imperial): 73.5 in
Overall Height (Metric): 187 cm
Overall Length (Imperial): 73.5 in
Overall Leng

3M™ Red Dot™ Monitoring Electrode with 3M™ Micropore™ Tape Backing, 2200 Series

Details

Micropore tape backing is conformable for increased patient comfort
Solid gel conforms to the skin allowing high quality, uninterrupted traces
Provide good performance for up to 30 days after pouch is opened

Typical properties

Age Group: Adult, Neonatal
Application: Intensive, universally applicable
Backing Material: Fleece
Brands: Red Dot™
Case Packaging: 50 Electrodes/Bag; 20 Bags or 1000 Electrodes/Case
Cladimed Code: K51FG01
Department: EMS/ER, ICU/CCU, OR, Pediatric ICU
Electrode Size: 1.75", 2.4" Diameter
Electrode Type: Diaphoretic, Monitoring, Pediatric
Factory ISO Certification: No ISO Certification information available
Gel Type: Solid
Material: Micropore Paper Tape
Model: 2239, 2248-50, 2249-50
Monitoring Event: Echo-Cardio, Pediatric Monitoring, Telemetry/Holter/Event
Package Contents: 50 Electrodes/Bulk Bag
Patient: Adult, Neonatal, Pediatric
Pre-wired: No
Product Type: Electrode
Product Type Free Format: Electrode
Product Use: Diaphoretic, Monitoring
Radiolucency: Radiopaque
Skin Prep Included: No
Skin Type: Fragile, Normal
Solution: Fragile Skin, Monitoring, Pediatrics
Therapeutic Area and Conditions: ECG, Paediatric Monitoring
Units per Pack: 50
Wear Time: Up to Three Days
eClass 14 Classification Group: 34580108

Dimensions and Classifications

Overall Diameter (Imperial): 1.75 in, 2.4 in
Overall Diameter (Metric): 4.4 cm, 6.1 cm

3M™ Littmann® Stethoscope Spare Parts Kit, Snap Tight Soft-Sealing Eartips

Details

Snap-tight, soft-sealing eartips conform to individual ears for an excellent acoustic seal and comfortable fit. Eartips snap firmly onto the ends of the eartubes and, for safety, require a significant effort to remove

Typical properties

Brands: Littmann®

Cladimed Code: K50BE02

Factory ISO Certification: No ISO Certification information available

Kit Includes: 2 Snap Tight Soft-Sealing Eartips - Large, 2 Snap Tight Soft-Sealing Eartips - Small

Model: All Stethoscopes

Product Color: Black, Gray

Product Type: Spare Parts Kit

eClass 14 Classification Group: 34340191

3M™ Precise™ Multi-Shot Disposable Skin Stapler

Typical properties

Brands: Precise™

Cladimed Code: F52BB01

Disposable: Yes

Factory ISO Certification: No ISO Certification information available

Model: DS-15, DS-25, DS-5

Product Type: Stapler

Product Use: Stapler

Staple Style: Arcuate

Staple Width: Wide

Stapler Capacity: 5 , 15 , 25

Sterile: Yes

Units per Pack: 12

eClass 14 Classification Group: 34330701

3M™ Steri-Drape™ Arthroscopy Sheet with Pouch, 1194

Typical properties

Cladimed Code: E51BA99,E51BG02
Factory ISO Certification: No ISO Certification information available
Incise Area Width (Metric): 12.5 cm
Material: Fabric
Model: 1194
Procedure: Orthopedic
Product Color: Blue
Product Type: Arthroscopy Sheet
Product Type Free Format: Drape
Product Use: Orthopedics
Sterile: Yes
Therapeutic Area and Conditions: Orthopaedic
Units per Pack: 5

Dimensions and Classifications

Overall Length (Imperial): 89 in
Overall Length (Metric): 228 cm, 304 cm
Overall Width (Imperial): 120 in
Overall Width (Metric): 292 cm, 304 cm

3M™ Steri-Drape™ Isolation Drape with Ioban™ 2 Incise Film and Pouch, 6610 Series

Typical properties

Cladimed Code: E51BA03

Factory ISO Certification: No ISO Certification information available

Features: Antimicrobial

Incise Area Length (Metric): 50 cm, 70 cm

Incise Area Width (Metric): 25 cm, 32 cm

Material: Plastic

Model: 6617, 6619

Procedure: General Surgery, Orthopedic

Product Color: Yellow

Product Type: Isolation Drape

Product Type Free Format: Drape

Product Use: Orthopedics

Therapeutic Area and Conditions: Orthopaedic

Units per Pack: 5

Dimensions and Classifications

Overall Length (Imperial): 125 in, 129 in

Overall Length (Metric): 320 cm, 328 cm

Overall Width (Imperial): 83 in, 100 in

Overall Width (Metric): 213 cm, 254 cm

3M™ Steri-Drape™ Operation Tape

Typical properties

Accessories: OP Tape
Cladimed Code: E51BA99
Factory ISO Certification: No ISO Certification information available
Incise Area Width (Metric): 92 cm
Material: Fabric
Model: 9099
Procedure: General Surgery
Product Color: Blue
Product Type: Utility Drape
Product Type Free Format: Drape
Product Use: Accessory
Sterile: No
Therapeutic Area and Conditions: All Surgeries
Units per Pack: 250

Dimensions and Classifications

Overall Length (Imperial): 4 in
Overall Length (Metric): 10 cm, 55 cm
Overall Width (Imperial): 21 in
Overall Width (Metric): 10 cm, 55 cm

3M™ Avagard™ Wall Bracket and Foot Pump

Typical properties

Accessory Type: Foot Pump, Foot Pump & Bracket

Brands: Avagard™

Dispensing System: Foot Pump

Factory ISO Certification: No ISO Certification information available

Model: 9201

Product Type: Dispenser, Bracket & Accessory

Product Use: Accessory, Wall Bracket

eClass 14 Classification Group: 20420207

3M™ Scotchpak™ Fluoropolymer Coated Polypropylene Release Liner, 9741, 10 in x 1900 yd

3M ID 7010413754

Details

Transparent
Excellent chemical stability
Fluoropolymer release coating applied to one side
Occlusive

Typical properties

Brands: Scotchpak™
Factory ISO Certification: No ISO Certification information available
eClass 14 Classification Group: 15360503

Dimensions and Classifications

Overall Length (Imperial): 1900 yd
Overall Length (Metric): 1737.36 m
Overall Width (Imperial): 10 in
Overall Width (Metric): 25.4 cm

3M™ Replacement Filter

Typical properties

Brands: 3M™
Cladimed Code: Non applicable,F59AB99
Clinical Area: ER, OR, PACU, Pre-op
Environmental claim being made: Yes
Environmental claim relates to: Product
Factory ISO Certification: No ISO Certification information available
Filter Type: Every 12 months or after 500 operating hours
Fluid Type: Blood/Fluid
Hardware: Accessory
Model: 90009, 90029, 90047
Pressure Infusion: Up to 300 mmHg maximum dynamic operating pressure
Priming Volume: 64 mL
Product Type: Accessory
Quantity: 10 Case,1 each
Sterile: Ethylene Oxide (EO)
Units per Pack: 1 , 5

Dimensions and Classifications

Overall Diameter (Imperial): 5.5 in
Overall Diameter (Metric): 14 cm
Overall Length (Imperial): 2.5 in
Overall Length (Metric): 14 cm

**3M™ Bair Hugger™ 800 Series Warming Unit Temperature Test Kit,
90055, Model 875, 1 Each**

3M ID 7100237056 UPC 00707387804442

Typical properties

Brands: Bair Hugger™

Cladimed Code: F59AB99

Clinical Area: PACU, Pre-op

Factory ISO Certification: No ISO Certification information available

Hardware: Accessory

Product Type: Accessory

Quantity: 1 each

3M™ Medical Tape, 9836

Details

Acrylic Adhesive
Fluid Resistant
Printable
Conformable

Typical properties

Adhesive Material: Acrylate
Adhesive Type: Acrylic/Acrylate
Backing Caliper: 1 mil
Backing Caliper (Metric): 25 Micron
Backing Material: Polyurethane
Backing Thickness (Imperial): 0.8 mil
Backing Thickness (Metric): 25 Micron
Brands: 3M™
Breathable: Yes
Conformability: Very High
Factory ISO Certification: No ISO Certification information available
Fluid Resistance Backing/Carrier: Yes
Hypoallergenic: No
Liner Caliper (Metric): 130 Micron
Liner Caliper (mils): 5 mil
Liner Color: White
Liner Material: Poly Carrier/Paper
Liner Weight: 78.0 lb.
Liner Weight (Metric): 127 g/m²
Material: Polyurethane
Maximum Length (Metric): 640 m
Maximum Width Capacity: 46 in
Maximum Width Capacity (Metric): 1170 mm
Printable Backing: Yes
Product Color: Transparent
Product Type: Polyester, Incise & Polyurethane
Product Usage: Adhesion to Skin
Sterilization Method: Ethylene Oxide (EO), Gamma
Tape Color: Transparent
Tape Total Caliper: 2.0 mil
Tape Total Caliper (Metric): 50.0 Micron
Tape Type: Single-sided Polyurethane Tape
eClass 14 Classification Group: 34180101

Dimensions and Classifications

Overall Thickness (Imperial): 1.875 in
Overall Thickness (Metric): 0.05 mm
Overall Width (Imperial): 46 in
Overall Width (Metric): 121.92 cm

3M™ Kerramax Care™ Gentle Border Dressing

Details

Super-absorbent dressings for absorbing and retaining high levels of exudate^{1*}

Sequesters and retains bacteria and MMPs^{2*,3*} away from the wound bed, preventing the transmission risk of infection

Gentle silicone adhesive border sec

Typical properties

Brands: Kerramax Care™

Factory ISO Certification: No ISO Certification information available

Inner Packs per Case: 10 Cartons per Case, 13 Cartons per Case, 19 Cartons per Case, 20 Cartons per Case

Total Units per Case: 100 per Case, 130 per Case, 190 per Case, 200 per Case

Units per Inner Pack: 10 per Carton

eClass 14 Classification Group: 34400201

Dimensions and Classifications

Overall Length (Imperial): 4 in, 6 in, 8 in, 10 in

Overall Length (Metric): 10.16 cm, 15.24 cm, 20.32 cm, 25.4 cm

Overall Width (Imperial): 4 in, 6 in, 8 in

Overall Width (Metric): 10.16 cm, 15.24 cm, 20.32 cm

3M™ Blue Standard Veterinary X-ray Film (Blue sensitive), 8" x 10"

3M ID 70200729385 UPC 50051115052953

Details

- Minimizes effects of patient motion
- Reduces unnecessary radiation exposure
- Extends X-ray tube life
- Can be used with portable machines
- Increased diagnostic information
- Fewer retakes needed
- Reduce cost
- Saves time and money
- Increased diagnostic ability

Typical properties

- Brands: 3M™
- Factory ISO Certification: No ISO Certification information available
- Package Contents: 100 Sheets
- Product Type: X-Ray Film
- eClass 14 Classification Group: 34260500

3M™ Blue Standard Veterinary X-ray Film (Blue sensitive), 10" x 12"

3M ID 70200729393 UPC 30051115052966

Details

- Minimizes Effects Of Patient Motion
- Reduces Unnecessary Radiation Exposure
- Extends X-Ray Tube Life
- Can Be Used With Portable Machines
- Increased Diagnostic Information
- Fewer Retakes Needed
- Reduce Cost
- Saves Time And Money
- Increased Diagnostic Abili

Typical properties

- Brands: 3M™
- Factory ISO Certification: No ISO Certification information available
- Package Contents: 100 Sheets
- Product Type: X-Ray Film
- eClass 14 Classification Group: 34260500

3M™ Blue Standard Veterinary X-ray Film (Blue sensitive), 14" x 17"

3M ID 70200729419 UPC 30051115052980

Details

- Minimizes Effects Of Patient Motion
- Reduces Unnecessary Radiation Exposure
- Extends X-Ray Tube Life
- Can Be Used With Portable Machines
- Increased Diagnostic Information
- Fewer Retakes Needed
- Reduce Cost
- Saves Time And Money
- Increased Diagnostic Abili

Typical properties

- Brands: 3M™
- Factory ISO Certification: No ISO Certification information available
- Package Contents: 100 Sheets
- Product Type: X-Ray Film
- eClass 14 Classification Group: 34260500

3M™ Green Standard Veterinary X-ray Film, 14" x 17",1436G

3M ID 70200743188 UPC 00051115053764

Details

- Minimizes Effects Of Patient Motion
- Reduces Unnecessary Radiation Exposure
- Extends X-Ray Tube Life
- Can Be Used With Portable Machines
- Increased Diagnostic Ability
- Fewer Retakes Needed
- Saves Time And Money
- Size: 14" X 17"

Typical properties

- Brands: 3M™
- Factory ISO Certification: No ISO Certification information available
- Package Contents: 100 Sheets
- Product Type: X-Ray Film
- eClass 14 Classification Group: 34260500

3M™ Green Standard Veterinary X-ray Film, 10" x 12",1436G

3M ID 70200743170 UPC 00051115053757

Details

- Minimizes Effects Of Patient Motion
- Reduces Unnecessary Radiation Exposure
- Extends X-Ray Tube Life
- Can Be Used With Portable Machines
- Increased Diagnostic Ability
- Fewer Retakes Needed
- Saves Time And Money
- Size: 10" X 12"

Typical properties

- Brands: 3M™
- Factory ISO Certification: No ISO Certification information available
- Package Contents: 100 Sheets
- Product Type: X-Ray Film
- eClass 14 Classification Group: 34260500

1413B 11X14 STANDARD BLUE VETERINARY X-RAY FILM 100/INR, 5 INR/CV

3M ID 70200729401 UPC 30051115052973

Details

- Minimizes effects of patient motion
- Reduces unnecessary radiation exposure
- Extends X-ray tube life
- Can be used with portable machines
- Increased diagnostic information
- Fewer retakes needed
- Reduce cost
- Saves time and money
- Increased diagnostic abili

Typical properties

- Brands: 3M™
- Factory ISO Certification: No ISO Certification information available
- Package Contents: 100 Sheets
- Product Type: X-Ray Film
- eClass 14 Classification Group: 34260500

3M™ Red Dot™ Trace Prep 2236, 3/4 inch x 196 inch (18,1mm x 5m), Roll with Dispenser, (36 Roll/Case)

3M ID 7000136750 UPC 00707387000011

Details

A trusted 3M abrasive material

Typical properties

Age Group: Adult

Brands: Red Dot™

Department: Cardiac Rehab, Cath Lab, EMS/ER, ICU/CCU, OR, Pediatric ICU

Electrode Size: 0.75" x 196"

Electrode Type: Diaphoretic

Factory ISO Certification: No ISO Certification information available

Model: 2236

Monitoring Event: Echo-Cardio, Pediatric Monitoring, Stress Test, Telemetry/Holter/Event

Patient: Adult, Pediatric

Pre-wired: No

Product Type: Electrode

Product Type Free Format: ECG Abrader Tape

Product Use: Diaphoretic

Skin Prep Included: No

Skin Type: Normal

Solution: Prepping Skin

Therapeutic Area and Conditions: Artefact, ECG, Skin Impedance, Skin Prep

Total Units per Case: 36 per Case

Units per Pack: 36

eClass 14 Classification Group: 34580108

Dimensions and Classifications

Overall Length (Imperial): 196 in

Overall Length (Metric): 5 m

Overall Width (Imperial): 0.75 in

Overall Width (Metric): 18 mm

3M™ Precise™ Vista Disposable Skin Stapler

Typical properties

Brands: Precise™

Cladimed Code: F52BB01,F51BB

Disposable: Yes

Factory ISO Certification: No ISO Certification information available

Model: 3995, 3996

Product Type: Stapler, Vista

Product Type Free Format: Skin Stapler

Product Use: Stapler

Staple Style: Box Style, Wide

Staple Width: Wide

Stapler Capacity: 15 , 35

Sterile: Yes

Therapeutic Area and Conditions: Disposable Surgical Stapler

Units per Pack: 6

eClass 14 Classification Group: 34330701

3M™ Steri-Drape™ Incise Drape, 1000 Series

Typical properties

Accessories: Miscellaneous
Cladimed Code: E51BA99
Clinical Area: Surgery
Clinical Sub-Area: Obstetrics and Gynaecology, Orthopedics
Factory ISO Certification: No ISO Certification information available
Features: Clear
Incise Area Width (Metric): 25 cm
Material: Plastic
Model: 1040, 1051
Procedure: General Surgery
Product Color: Transparent
Product Type: Incise Drapes
Product Type Free Format: Drape
Product Use: Incise
Sterile: No, Yes
Units per Pack: 10 , 200

Dimensions and Classifications

Overall Length (Imperial): 13 in, 23 in
Overall Length (Metric): 10 cm, 35 cm, 60 cm
Overall Width (Imperial): 13 in, 33 in
Overall Width (Metric): 20 cm, 35 cm, 45 cm, 85 cm

3M™ Steri-Drape™ Long U-Drape, 1019

Typical properties

Accessories: Miscellaneous
Additional Drapes: Sheet
Cladimed Code: E51BA99
Factory ISO Certification: No ISO Certification information available
Loophole Length (Metric): 16 cm
Loophole Width (Metric): 49 cm
Material: Plastic
Model: 1019
Procedure: Orthopedic
Product Color: Transparent
Product Type: U-drape
Product Type Free Format: Drape
Product Use: Surgical Sheet
Sterile: Yes
Therapeutic Area and Conditions: Orthopaedic
Units per Pack: 10

Dimensions and Classifications

Overall Length (Imperial): 71 in
Overall Length (Metric): 180 cm
Overall Width (Imperial): 47 in
Overall Width (Metric): 120 cm

3M™ Steri-Drape™ Basic Surgical Pack, 9000 Series

Typical properties

Additional Drapes: Pack

Cladimed Code: E51AA01

Factory ISO Certification: No ISO Certification information available

Model: 9000A, 9000LA, 9010

Procedure: General Surgery

Product Color: Blue

Product Type: Fabric Drapes, Surgical Pack

Product Type Free Format: Drape

Product Use: General Surgery

Therapeutic Area and Conditions: General Surgery, Obstetrics and Gynaecology,
Orthopaedic, Urology

Units per Pack: 5 , 7

3M™ Scotchpak™ Polyester Backing Film Laminate, 9733, 7 in x 6000 ft

3M ID 7010386240

Details

Translucent
Occlusive
Conformable
Controlled caliper

Typical properties

Backing (Carrier) Material: Polyester
Brands: Scotchpak™
Catalog Number: 9733
Factory ISO Certification: No ISO Certification information available
Product Type: Transdermal Backing
eClass 14 Classification Group: 41011103

Dimensions and Classifications

Overall Length (Imperial): 2000 yd
Overall Length (Metric): 1828.8 m
Overall Width (Imperial): 7 in
Overall Width (Metric): 177.8 mm

3M™ Reusable Cold/Hot Pack, 1570 Series

Typical properties

Boxes per Case: 10.0
Brands: 3M™
Catalog Number: 1570
Factory ISO Certification: No ISO Certification information available
Product Color: Blue
Reusable: Yes
Therapy Type: Cold/Hot
Units per Box: 2.0
Units per Case: 20.0
eClass 14 Classification Group: 34400201

Dimensions and Classifications

Overall Length (Imperial): 10 in
Overall Length (Metric): 25.4 cm, 27 cm
Overall Width (Imperial): 4 in
Overall Width (Metric): 10.16 cm, 11 cm

3M™ Ioban™ Special Incise Drape

Typical properties

Accessories: Miscellaneous
Cladimed Code: E51BA99,E51DA01
Clinical Area: Surgery
Clinical Sub-Area: Obstetrics and Gynaecology, Orthopedics
Factory ISO Certification: No ISO Certification information available
Features: Clear
Material: Plastic
Model: 1035, 1050
Procedure: General Surgery
Product Color: Transparent
Product Type: Incise Drapes
Product Type Free Format: Drape
Product Use: Incise
Sterile: Yes
Units per Pack: 10

Dimensions and Classifications

Overall Length (Imperial): 4 in, 23 in
Overall Length (Metric): 10 cm, 35 cm, 60 cm
Overall Width (Imperial): 8 in, 17 in
Overall Width (Metric): 20 cm, 35 cm, 45 cm

3M™ PRESS-ON™ Aspheric Lens

Typical properties

Brands: PRESS-ON™

Catalog Number: 90-20800,90-20600,90-21600,90-20400,90-20300,90-21400,90-20200,90-20100,90-21200,90-21000,90-20350,90-20250,90-20150,90-20050

Conformability: High

Diopter: 0.50, 1.00, 1.50, 10.00, 12.00, 14.00, 16.00, 2.00, 2.50, 3.00, 3.50, 4.00, 6.00, 8.00

Factory ISO Certification: No ISO Certification information available

Hypoallergenic: No

Printable Backing: No

Product Type: Aspheric Lens

Product Usage: Medical Device

3M™ Steri-Drape™ TUR Drape, 1081

Typical properties

Cladimed Code: E51DA03,E51BH03
Factory ISO Certification: No ISO Certification information available
Loophole Length (Metric): 6 cm
Material: Fabric
Model: 1081
Procedure: Urology
Product Color: Blue
Product Type: TUR Drape
Product Type Free Format: Drape
Product Use: Cardiovascular|Urology, Urology
Sterile: Yes
Therapeutic Area and Conditions: Urology
Units per Pack: 14

Dimensions and Classifications

Overall Length (Metric): 164 cm
Overall Width (Imperial): 60 in
Overall Width (Metric): 152 cm

3M™ Steri-Drape™ Aperture Pouch Drape, 1000 Series

Typical properties

Accessories: Aperture, Bags and Pouches

Cladimed Code: E51BI01,E51BH04

Factory ISO Certification: No ISO Certification information available

Loophole Length (Metric): 11 cm

Loophole Width (Metric): 8.5 cm

Material: Fabric, Plastic

Model: 1072, 1084

Procedure: Obstetrics and Gynaecology, Urology

Product Color: Blue, Transparent

Product Type: Aperture Pouch Drape, Under Buttocks Drape

Product Type Free Format: Drape

Product Use: Gynecology

Sterile: Yes

Therapeutic Area and Conditions: General Surgery, Obstetrics and Gynaecology, Urology

Units per Pack: 10 , 30

Dimensions and Classifications

Overall Length (Imperial): 9 in, 34 in

Overall Length (Metric): 23 cm, 86 cm

Overall Width (Imperial): 17 in, 42 in

Overall Width (Metric): 45 cm, 108 cm

3M™ Littmann® Stethoscope Spare Parts Kit, Master Classic™

Typical properties

Brands: Littmann®

Cladimed Code: K50BE02

Diaphragm Diameter (Imperial): 1.75 in

Diaphragm Diameter (Metric): 4.4 cm

Factory ISO Certification: No ISO Certification information available

Kit Includes: Snap Tight Soft-Sealing Eartips - Small, Tunable Rim/Diaphragm Assembly

Model: Master Classic II™

Product Color: Black, Gray

Product Type: Spare Parts Kit

Units per Pack: 10

eClass 14 Classification Group: 34340191

3M™ Defib Pads, 2340 Series

Details

Saves time, easy to remove from patient, no clean-up
Bright orange solid gel pads are easy to see, require no cleanup, and leave no slippery residue that can interfere with CPR
Self-contained to eliminate inadvertent “gel bridging” which can cause skin

Typical properties

Boxes per Case: 10.0
Brands: 3M™
Cladimed Code: Non applicable
Clinical Area: Critical Care, Emergency Medical Services (EMS), Emergency Room, Intensive Care, Pediatric, Physician Office, Surgery
Department: Cardiac Rehab, Cath Lab, EMS/ER, ICU/CCU, NICU, OR, Pediatric ICU
Factory ISO Certification: No ISO Certification information available
Model: 2345N, 2346N
Product Type: Defibrillation
Product Use: Procedure Specific
Therapeutic Area and Conditions: Ambulance, Cardiac Arrest, Defibrillator Pads
Units per Case: 100.0
Units per Pack: 10
eClass 14 Classification Group: 34240112

Dimensions and Classifications

Overall Length (Imperial): 4.5 in, 6 in
Overall Length (Metric): 11.4 cm, 15.2 cm
Overall Width (Imperial): 4.5 in
Overall Width (Metric): 11.4 cm

3M™ Kerralite Cool™ Border Moisture Balancing Hydrogel Dressing

Details

Hydrogel moisture balancing dressing with Pro-ionic™⁵ Technology
Polyurethane outer film is fluid repellent and highly breathable protecting the wound from bacteria and the external environment whilst being permable to moisture
Gentle adhesiv

Typical properties

Brands: Kerralite Cool™
Factory ISO Certification: No ISO Certification information available
Inner Packs per Case: 32 Cartons per Case, 52 Cartons per Case, 104 Cartons per Case
Total Units per Case: 160 per Case, 260 per Case, 520 per Case
Units per Inner Pack: 5 per Carton
eClass 14 Classification Group: 34400201

3M™ N-A™ ULTRA Knitted Viscose Primary Dressing

3M ID B5005265103

Details

Atraumatic¹
Allows free passage of exudate

Typical properties

Brands: N-A™
eClass 14 Classification Group: 34210402

3M™ Steri-Drape™ Cardiovascular Sheet with Ioban™ 2 Incise Film

Typical properties

Cladimed Code: E51BF99

Factory ISO Certification: No ISO Certification information available

Features: Antimicrobial

Incise Area Length (Metric): 41 cm

Incise Area Width (Metric): 25 cm, 30 cm

Material: Fabric

Model: 6677, 6681

Procedure: Cardiovascular

Product Type: Cardiovascular Sheet

Product Type Free Format: Drape

Product Use: Cardiovascular

Therapeutic Area and Conditions: Cardiovascular

Units per Pack: 6 , 8

Dimensions and Classifications

Overall Length (Imperial): 100 in

Overall Length (Metric): 254 cm

Overall Width (Imperial): 150 in, 151 in

Overall Width (Metric): 381 cm, 384 cm

3M™ Steri-Drape™ Medium Drape with Incise Film, 1060 Series

Typical properties

Accessories: Miscellaneous
Cladimed Code: E51BD01
Factory ISO Certification: No ISO Certification information available
Features: Clear
Incise Area Length (Metric): 10 cm
Incise Area Width (Metric): 12.5 cm
Material: Plastic
Model: 1060
Procedure: EENT
Product Color: Transparent
Product Type: Drape Sheet, Incise Drapes
Product Type Free Format: Drape
Product Use: EENT, Incise
Sterile: Yes
Therapeutic Area and Conditions: General Surgery, Ophthalmic
Units per Pack: 10

Dimensions and Classifications

Overall Length (Imperial): 51 in
Overall Length (Metric): 130 cm
Overall Width (Imperial): 51 in
Overall Width (Metric): 130 cm

3M™ Medical Component, 9779, Flexform Wire Tape

Typical properties

Adhesive Material: Acrylate
Adhesive Type: Acrylic/Acrylate (High Tack)
Brands: 3M™
Breathable: No
Conformability: High
Factory ISO Certification: No ISO Certification information available
Fluid Resistance Backing/Carrier: Yes
Hypoallergenic: No
Liner Caliper (Metric): 130 Micron
Liner Caliper (mils): 5.7 mil
Liner Material: Paper
Liner Weight: 78.0 lb.
Liner Weight (Metric): 127 g/m²
Material: Polyolefin
Maximum Length (Metric): 320 m
Maximum Width Capacity: 0.34 in
Maximum Width Capacity (Metric): 9 mm
Printable Backing: No
Product Color: Blue, White
Product Type: Flexform Wire Tape Roll
Product Usage: Formation
Sterilization Method: Ethylene Oxide (EO), Gamma
Tape Color: Blue, White
Tape Type: Closure

Dimensions and Classifications

Overall Width (Imperial): 3.425 in
Overall Width (Metric): 87 mm

3M™ Steri-Vac™ Sterilizer/Aerator, GS Series

Details

Cleared for use with single- or dual-channel rigid and flexible scopes, with no restrictions on the length or inner diameter of endoscope channels
The single-use, 3M™ Steri-Gas™ Cartridge (100% EO) is punctured only when the chamber door is sealed and th

Typical properties

Brands: Steri-Vac™

Chamber Capacity (Imperial): 4.8 ft³, 7.9 ft³

Chamber Capacity (Metric): 136 Liter, 224 Liter

Chamber Dimensions (h x w x d) (Metric): 38.0 × 43.0 × 83.0 cm (15.0 × 17.0 × 32.5 in.), 46.0 × 51.0 × 97.0 cm (18.0 × 20.0 × 38.0 in.)

Chamber Volume: 224 L (7.9 ft³), 136 L (4.8 ft³)

Door Configuration: 1,2

Factory ISO Certification: No ISO Certification information available

Model: GS5-1D, GS5-2D, GS8-1D, GS8-2D

Product Type: Sterilizer

Product Use: Accessory

Sterilization Cycle: 38 °C, 270 min, 55 °C, 60 min

Sterilization Method: Ethylene Oxide (EO)

eClass 14 Classification Group: 36070101

3M™ Attest™ Steam Load Record Cards, 1243LR, 100 ea/case

3M ID 7100190249 UPC 50707387785784

Details

Use to record all load information for either a steam cycle
Attach your 3M™ Attest™ Steam Chemical Integrator to the Load Record Card
after post-sterilization
No expiration date for these Load Record Cards
100 each per case

Typical properties

Brands: Attest™
Factory ISO Certification: No ISO Certification information available
eClass 14 Classification Group: 34410209

3M™ Bair Hugger™ 500/700 Series Warming Unit Temperature Test Kit, 22110, 1 Each

3M ID 7100236966 UPC 00707387804459

Typical properties

Brands: Bair Hugger™

Cladimed Code: F59AB99

Factory ISO Certification: No ISO Certification information available

Product Type: Accessory

Quantity: 1 each

3M™ Medical Tape, 9907

Details

Acrylic Adhesive
Breathable
Conformable
Printable with treatment

Typical properties

Adhesive Material: Acrylate
Adhesive Type: Acrylic/Acrylate, Acrylic/Acrylate (Tack)
Backing (Carrier) Material: Elastic Polymer Blend Non-woven
Brands: 3M™
Breathable: Yes
Conformability: High
Factory ISO Certification: No ISO Certification information available
Fluid Resistance Backing/Carrier: No
Hypoallergenic: No
Latex: No
Liner Caliper (Metric): 90 Micron, 110 Micron
Liner Caliper (mils): 3.5 mil, 4.5 mil
Liner Color: White
Liner Material: Paper
Liner Weight: 53.0 lb., 60.0 lb.
Liner Weight (Metric): 88 g/m², 98 g/m²
Material: Elastic Nonwoven Polymer
Maximum Length (Metric): 375 m, 548 m
Maximum Width Capacity (Metric): 1270 mm
Printable Backing: Yes
Product Color: Tan, White
Product Type: Non-woven Polyurethane Tape
Product Usage: Adhesion to Skin, Adhesion to Substrate
Sterilization Method: Ethylene Oxide (EO), Gamma
Tape Color: Tan, White
Tape Total Caliper: 10.0 mil, 11.0 mil
Tape Total Caliper (Metric): 280.0 Micron, 250.0 Micron
Tape Type: Single Sided Elastic Nonwoven Fabric Tape
eClass 14 Classification Group: 34180201

Dimensions and Classifications

Overall Thickness (Imperial): 0.83 in, 1 in
Overall Thickness (Metric): 0.25 mm, 0.28 mm
Overall Width (Imperial): 50 in
Overall Width (Metric): 127 cm

Nexcare™ Cold/Hot Pack 2671PEG, 4 in x 10 in

3M ID 70005264075 UPC 00051131666887

Details

Stretchy strap holds the pack in place for hassle-free relief
Flexible design is ideal for use on multiple body parts
Heat therapy is great for muscle aches, cramps, stiffness and arthritis
Cold therapy is ideal for sprains, strains, bumps, bruises and

Typical properties

Application: Reusable, Sports
Body Part: Multi-Purpose
Brands: Nexcare™
Condition: Aches/Sprains/Strains, Bruises/Muscle Aches/Swelling
Factory ISO Certification: No ISO Certification information available
Package Contents: 1 Pack
Product Color: White
Product Type: Cold/Hot
Reusable: Yes
Sizes Available: Adjustable
Solution for: Reusable, Sports
Therapy Type: Cold/Hot
Wound Type: Bumps / Bruises
eClass 14 Classification Group: 34400201

Dimensions and Classifications

Overall Length (Imperial): 10 in
Overall Length (Metric): 254 mm
Overall Width (Imperial): 4 in
Overall Width (Metric): 101.6 mm

3M™ Medical Loop Fastener, 7330

Details

Available with Synthetic Rubber Adhesive or No Adhesive
Easy to open yet high shear strength during use
Low Profile

Typical properties

Backing Caliper: 10 mil
Backing Caliper (Metric): 250 Micron
Brands: 3M™
Breathable: No
Conformability: High
Factory ISO Certification: No ISO Certification information available
Liner Material: Paper
Printable Backing: No
Product Color: White
Product Type: Medical Fastener
Product Usage: Device Closure
Tape Type: Closure

3M™ Steri-Drape™ Caesarean-Section Sheet with Aperture Pouch, 7960 Series

Typical properties

Cladimed Code: E51BI03

Factory ISO Certification: No ISO Certification information available

Features: Clear

Incise Area Length (Metric): 30 cm

Incise Area Width (Metric): 35 cm, 60 cm

Material: Fabric

Model: 7965, 7966

Procedure: Obstetrics and Gynaecology

Product Color: Blue

Product Type: C-section Drape, C-section Sheet

Product Type Free Format: Drape

Product Use: Specialty Sheet

Sterile: Yes

Therapeutic Area and Conditions: Obstetrics and Gynaecology

Units per Pack: 5

Dimensions and Classifications

Overall Length (Imperial): 77 in, 100 in

Overall Length (Metric): 196 cm, 254 cm, 307 cm

Overall Width (Imperial): 121 in, 122 in

Overall Width (Metric): 254 cm, 308 cm, 310 cm

3M™ Steri-Drape™ Wound Edge Protector, 1070 Series

Typical properties

Accessories: Miscellaneous
Brands: Steri-Drape™
Cladimed Code: E51BA05
Factory ISO Certification: No ISO Certification information available
Loophole Length (Metric): 9.5 cm, 12.5 cm, 17.5 cm, 22.5 cm, 27.5 cm
Material: Plastic
Model: 1073, 1074, 1075, 1076
Procedure: General Surgery
Product Color: Transparent
Product Type: Wound Edge Protector
Product Type Free Format: Drape
Product Use: General Surgery
Therapeutic Area and Conditions: General Surgery
Units per Pack: 10

Dimensions and Classifications

Overall Length (Imperial): 35 in
Overall Length (Metric): 90 cm
Overall Width (Imperial): 35 in
Overall Width (Metric): 90 cm

3M™ Universal Electrosurgical Plate

Typical properties

Backing Material: Fleece/polyethylene

Brands: 3M™

Cladimed Code: F52GA06

Cord Configuration: Cordless, Pre-Attached Cord

Department: OR

Factory ISO Certification: No ISO Certification information available

Pad Type: Solid, Split

Product Type: Diathermy Plate

Units per Pack: 1

eClass 14 Classification Group: 34580113

Dimensions and Classifications

Overall Length (Metric): 13.2 cm

Overall Width (Metric): 12 cm

3M™ Cavilon™ Extra Dry Skin Cream 3386

3M ID 7000053988 UPC 50707387447026

Details

Versatile moisturizing dry skin lotion that is ideal for diabetic foot care and treatment of other dry skin conditions anywhere on the body

Long-lasting 24-hour moisturization

Latex-free, fast-absorbing, non-greasy moisturizing cream for dry skin vanish

Typical properties

Anti-fungal: No

Brands: Cavilon™

Condition: Skin Care

Delivery System: Tube

Department: Cardiovascular, Critical Care, Dialysis Center, EMERGENCY, Intensive Care Unit, Labor & Delivery, Medical-Surgical, Oncology, Pediatrics, Urgent Care, Wound Care

Dressing and Device Securement Condition Type: Adhesive Trauma, Skin Injuries-Allergic & Irritant Contact Dermatitis, Skin Injuries-Maceration, Skin Injuries-Mechanical, Surgical Wound, Tube & Device Securement-Infusion & Monitoring, Tube & Device Securement-Lightweight Tubes & Devices

Factory ISO Certification: No ISO Certification information available

Hypoallergenic: Yes

Latex: No

Moisturizing: Yes

Product Form: Tube

Product Type: Skin Care

Volume (Imperial): 4 fl oz

Volume (Metric): 118 mL

eClass 14 Classification Group: 40290501

3M™ Medical Tape, 1538

Details

Tackified Acrylic Adhesive
Adheres to High and Low Surface Energy Substrates
Strong, no stretch
Good Processability

Typical properties

Adhesive Material: Acrylate
Adhesive Type: Acrylic/Acrylate (Tack)
Backing (Carrier) Material: Rayon Woven Fabric
Brands: 3M™
Breathable: Yes
Conformability: Medium
Factory ISO Certification: No ISO Certification information available
Fluid Resistance Backing/Carrier: No
Hypoallergenic: No
Latex: No
Liner Caliper (Metric): 150 Micron
Liner Caliper (mils): 6 mil
Liner Color: White
Liner Material: None, Paper
Liner Weight: 83.0 lb.
Liner Weight (Metric): 135 g/m²
Material: Woven Rayon Acetate
Maximum Length (Metric): 320 m, 457 m
Maximum Width Capacity: 48 in
Maximum Width Capacity (Metric): 1220 mm
Printable Backing: Yes
Product Color: White
Product Type: Rayon Acetate Woven
Product Usage: Adhesion to Skin, Adhesion to Substrate
Sterilization Method: Ethylene Oxide (EO), Gamma
Tape Color: White
Tape Total Caliper: 8.0 mil
Tape Total Caliper (Metric): 200.0 Micron
Tape Type: Single Sided Rayon Woven Fabric Tape
eClass 14 Classification Group: 34180201

Dimensions and Classifications

Overall Thickness (Imperial): 1 in
Overall Thickness (Metric): 0.2 mm
Overall Width (Imperial): 48 in

3M™ Littmann® Stethoscope Spare Parts Kit, Master Cardiology™

Details

Contains one tunable diaphragm and rim assembly for the stethoscope chestpiece

Typical properties

Brands: Littmann®

Cladimed Code: K50BE02

Diaphragm Diameter (Imperial): 1.75 in

Diaphragm Diameter (Metric): 4.4 cm

Factory ISO Certification: No ISO Certification information available

Kit Includes: Snap Tight Soft-Sealing Eartips - Small, Tunable Rim/Diaphragm Assembly

Model: Master Cardiology™

Product Color: Black, Gray

Product Type: Spare Parts Kit

Units per Pack: 10

eClass 14 Classification Group: 34340191

3M™ Scotchpak™ Polyester Packaging Film Laminate, PF Series

Details

Occlusive
Heat sealable
Controlled caliper

Typical properties

Backing (Carrier) Material: Polyester
Brands: Scotchpak™
Caliper: 4.35 mils, 4 mil, 4.00 mils
Caliper (Metric): 101.6 µm, 110.49 µm, 101.60 µm
Catalog Number: PF450M, PF200M, PF400M, PF400W
Elongation CD: 59%, 0.56
Elongation MD: 0.75, 70%
Factory ISO Certification: No ISO Certification information available
Heat Seal: 19 lb/in, 26 lb/in, 18.5 lb/in
Heat Seal (Metric): 84.51 N/25.4 mm, 115.64 N/25.4 mm, 82.3 N/25.4 mm
Heat Seal Layer: Polyethylene (PE)
MVTR (g/m²/24 hr): 3.1, 7
Oxygen Transmission (cc/m²/24hr): 80, 93, 77.5
Product Color: Translucent, White
Sample Roll: 6 in x 25 yd, 6 in x 25 yds
Sample Roll (Metric): 15.24 cm x 22.86 m, 15 cm x 23 m
Tensile CD: 20.2 lb/in
Tensile CD (Metric): 89.85 N/25.4mm
Tensile MD: 16.3 lb/in
Tensile MD (Metric): 72.5 N/25.4 mm
eClass 14 Classification Group: 41011103

Dimensions and Classifications

Overall Length (Imperial): 1499.344 yd, 1500 yd
Overall Length (Metric): 1371 m, 1371.6 m, 1372 m
Overall Width (Imperial): 40 in
Overall Width (Metric): 101.6 cm, 102 cm

3M™ Steam Sterilization Record Envelopes, 1254E

Typical properties

Brands: 3M™

Factory ISO Certification: No ISO Certification information available

Model: 1254E-A, 1254E-F, 1254E-S

Product Type: Record Envelopes

Product Use: Record Keeping

Sterilization Method: Ethylene Oxide (EO), Steam

eClass 14 Classification Group: 34410209

Dimensions and Classifications

Overall Length (Imperial): 11.5 in

Overall Width (Imperial): 9.5 in

3M™ Medical Silicone Tape, 2477

Details

Breathable
Conformable
Repositionable

Typical properties

Adhesive Type: Silicone Acrylate
Backing Caliper: 1.5 mil
Backing Caliper (Metric): 40 Micron
Backing Material: Thermoplastic Elastomer (TPE) Film
Backing Thickness (Imperial): 1.5 mil
Backing Thickness (Metric): 40 Micron
Brands: 3M™
Breathable: Yes
Conformability: High
Factory ISO Certification: No ISO Certification information available
Fluid Resistance Backing/Carrier: Yes
Hypoallergenic: No
Liner Caliper (Metric): 80 Micron
Liner Material: Paper/ PP Film
Liner Weight (Metric): 98 g/m²
Material: Thermoplastic Elastomer (TPE)
Maximum Length (Metric): 183 m
Maximum Width Capacity: 23.75 in
Maximum Width Capacity (Metric): 603 mm
Printable Backing: No
Product Color: Transparent
Product Type: Double-coated Tape
Product Usage: Adhesion to Skin
Sterilization Method: Ethylene Oxide (EO)
Tape Color: Transparent
Tape Total Caliper: 7.2 mil
Tape Total Caliper (Metric): 180.0 Micron
Tape Type: Double-sided Thermoplastic Elastomer (TPE) Tape
eClass 14 Classification Group: 34180101

Dimensions and Classifications

Overall Thickness (Imperial): 2.3 mil
Overall Thickness (Metric): 0.18 mm
Overall Width (Imperial): 23.75 in
Overall Width (Metric): 60.3 cm

3M™ Tegaderm™ Hydrocolloid Thin Dressing

Details

May be used as a protective dressing on at-risk skin. May be used on intact skin to protect from friction
Film border on oval sizes seals to prevent premature dressing failure due to edge lift
Protects the wound and periwound skin from contaminants, bod

Typical properties

Brands: Tegaderm™
Dressing Type: Border
Factory ISO Certification: No ISO Certification information available
eClass 14 Classification Group: 34210405

Dimensions and Classifications

Overall Length (Imperial): 4 in, 4.75 in, 6 in
Overall Length (Metric): 10 cm, 12 cm, 15.2 cm
Overall Width (Imperial): 4 in, 5.25 in
Overall Width (Metric): 10 cm, 10.1 cm, 13.3 cm

3M™ Steri-Drape™ Adhesive Towel Drape

Typical properties

Accessories: Towel
Additional Drapes: Sheet
Brands: Steri-Drape™
Cladimed Code: E51DA05
Clinical Area: Surgery
Clinical Sub-Area: Obstetrics and Gynaecology, Orthopedics
Factory ISO Certification: No ISO Certification information available
Material: Fabric
Model: 1089, 9069, 9084, 9085, 9086, 9087, 9088
Procedure: General Surgery
Product Color: Blue
Product Type: Drape Sheet, Towel Drape, Utility Drape
Product Type Free Format: Drape
Product Use: Procedure Specific, Surgical Sheet
Sterile: Yes
Therapeutic Area and Conditions: All Surgeries, Surgical Procedures
Units per Pack: 2 , 25 , 30 , 40 , 75

Dimensions and Classifications

Overall Length (Imperial): 22 in, 29 in, 33 in, 35.5 in, 39 in, 72 in, 98 in
Overall Length (Metric): 55 cm, 57 cm, 75 cm, 85 cm, 90 cm, 100 cm, 183 cm,
250 cm
Overall Width (Imperial): 26 in, 29 in, 30 in, 39 in, 59 in, 72 in
Overall Width (Metric): 5

3M™ Steri-Drape™ Refractive Drape For LASIK, 1022

Typical properties

Accessories: Miscellaneous
Cladimed Code: E51BD01
Factory ISO Certification: No ISO Certification information available
Loophole Length (Metric): 4.4 cm
Loophole Width (Metric): 3.8 cm
Material: Plastic
Model: 1022
Procedure: EENT
Product Color: Transparent
Product Type: Refractive Drape
Product Type Free Format: Drape
Product Use: EENT
Sterile: No, Yes
Therapeutic Area and Conditions: Ophthalmic
Units per Pack: 20 , 200

Dimensions and Classifications

Overall Length (Imperial): 15 in
Overall Length (Metric): 40 cm
Overall Width (Imperial): 10 in
Overall Width (Metric): 27.5 cm

3M™ Universal Electrosurgical Pad

Details

No age or weight limitations
Safety ring allows a uniform distribution
Conductive adhesive allows to maximize good adhesion and conductivity
Easy removal

Typical properties

Backing Material: Fleece/polyethylene
Brands: 3M™
Cladimed Code: F52GA06
Cord Configuration: Cordless, Pre-Attached Cord
Department: OR
Factory ISO Certification: No ISO Certification information available
Pad Type: Solid, Split
Product Type: Diathermy Plate
Units per Pack: 1 , 5
eClass 14 Classification Group: 34580113

Dimensions and Classifications

Overall Length (Metric): 12 cm, 13.2 cm
Overall Width (Metric): 12 cm, 13.5 cm

3M™ LEAP™ III Pad

Details

Torque (slip) resistant
Conformable for all types of lens styles and base curves: low edge lifting
Adheres to various eyeglass lens materials
Finished good for Ophthalmic Industry
For use during edging or finishing of ophthalmic lenses

Typical properties

Adhesive Type: Synthetic Rubber
Backing Caliper: 22 mil
Backing Material: Foam
Backing Thickness (Imperial): 22 mil
Backing Thickness (Metric): 560 Micron
Brands: LEAP™
Breathable: No
Center Style: Hole
Conformability: High
Contents: 2,000 per box, 1,000 per box
Edging: Yes
Factory ISO Certification: No ISO Certification information available
Fluid Resistance Backing/Carrier: Yes
Hypoallergenic: No
Latex: Yes
Lens Type: Standard
Liner Caliper (Metric): 76 Micron
Liner Caliper (mils): 3 mil
Liner Color: White
Liner Material: Paper
Liner Weight: 53.0 lb.
Liner Weight (Metric): 86 g/m²
Material: Polyolefin Foam
Printable Backing: No
Product Type: LEAP™ III Finish Blocking Optical Lens Edging Pad, LEAP™ LSE Finish Blocking Pad
Product Usage: Optical Lens Processing
Shape: Oval, Round, Square
Surfacing: Yes
Tape Color: Clear
Tape Total Caliper: 30.0 mil
Tape Total Caliper (Metric): 760.0 Micron
Tape Type: LEAP™ III Finish Blocking Optical RX Lens Processing Pads

Dimensions and Classifications

Overall Diameter (Imperial): 0.709 in, 0.945 in, 1 in, 1854.768 yd
Overall Diameter (Metric): 18 mm, 24 mm, 26 mm, 1696 m

3M™ Tegaderm™ Transparent Dressing Frame Style with Border

Details

The CDC/HICPAC Guidelines for the Prevention of Intravascular Catheter-Related Infections base dressing change recommendations on studies with Tegaderm™ Film
Notched designs provide a better seal around the catheter
Breathable film allows moisture vapor

Typical properties

Border: Yes
Brands: Tegaderm™
Factory ISO Certification: No ISO Certification information available
Hypoallergenic: Yes
eClass 14 Classification Group: 34180304

Dimensions and Classifications

Overall Length (Imperial): 2.75 in, 4.75 in
Overall Length (Metric): 7 cm, 12.1 cm
Overall Width (Imperial): 2.375 in, 4 in
Overall Width (Metric): 6 cm, 10.16 cm

Telemetry Adapter

Typical properties

Brands: 3M™

Case Packaging: 50 Electrodes/Bag; 20 Bags or 1000 Electrodes/Case

Compatibility: Universal DIN

Disposable: No

Factory ISO Certification: No ISO Certification information available

Model: YMA3GE, YMA5DST, YMA5SD, YMA6GET

Number of Leads: 3, 5, 6

Product Type: Telemetry Adapter

Yoke Connection: Universal DIN

eClass 14 Classification Group: 34090507

3M™ Scotchpak™ Polyester Packaging Film Laminate, LF Series

Details

Translucent
Occlusive

Typical properties

Backing (Carrier) Material: Polyester
Brands: Scotchpak™
Caliper: 1.95 mils,3.95 mil,5.80 mils
Caliper (Metric): 147.32 μm,100.33 μm,49.53 μm
Catalog Number: LF200M,PF400M,LF580M
Elongation CD: 59%,0.59,60%
Elongation MD: 0.7,70%,90%
Factory ISO Certification: No ISO Certification information available
Heat Seal: 22.6 lb/in,15.2 lb/in,7 lbs/in
Heat Seal (Metric): 31.1 N/25.4 mm,100.53 N/25.4 mm,67.6 N/25.4 mm
Heat Seal Layer: Ethylene Vinyl Acetate (EVA)
MVTR (g/m²/24 hr): 40.3,15.5,4.8
Oxygen Transmission (cc/m²/24hr): 89.9,51.2,14.7
Product Color: Translucent
Sample Roll: 6 in x 25 yd,6 in x 25 yds
Sample Roll (Metric): 15.24 cm x 22.86 m,15 cm x 23 m
Tensile CD: 23.2 lb/in
Tensile CD (Metric): 103.2 N/25.4 mm
Tensile MD: 18.3 lb/in
Tensile MD (Metric): 81.4 N/25.4 mm
eClass 14 Classification Group: 41011103

Dimensions and Classifications

Overall Length (Imperial): 1500 yd
Overall Length (Metric): 1371.6 m, 1372 m
Overall Width (Imperial): 40 in
Overall Width (Metric): 101.6 cm, 102 cm, 1020 cm

3M™ Steri-Drape™ Caesarean-Section Drape with Incise Pouch, 7960 Series

Typical properties

Additional Drapes: Sheet
Cladimed Code: E51AH04
Factory ISO Certification: No ISO Certification information available
Features: Clear
Incise Area Width (Metric): 60 cm
Material: Fabric
Model: 7965NS
Procedure: Obstetrics and Gynaecology
Product Color: Blue
Product Type: C-section Drape, C-section Sheet
Product Use: Procedure Specific, Specialty Sheet
Sterile: Yes
Units per Pack: 5

Dimensions and Classifications

Overall Length (Imperial): 118 in
Overall Length (Metric): 300 cm
Overall Width (Imperial): 100 in
Overall Width (Metric): 254 cm

3M™ Steri-Drape™ Large Towel Drape, 1010

Typical properties

Accessories: Towel
Cladimed Code: E51BA99
Factory ISO Certification: No ISO Certification information available
Material: Plastic
Model: 1010, 1010NSD
Procedure: General Surgery
Product Color: Transparent
Product Type: Towel Drape
Product Type Free Format: Drape
Product Use: Surgical Sheet
Therapeutic Area and Conditions: General Surgery
Units per Pack: 10

Dimensions and Classifications

Overall Length (Imperial): 17 in
Overall Length (Metric): 45 cm, 50 cm
Overall Width (Imperial): 23 in
Overall Width (Metric): 50 cm, 60 cm

3M™ Steri-Drape™ Small Towel Drape, 1000

Typical properties

Accessories: Towel
Cladimed Code: E51BA99
Factory ISO Certification: No ISO Certification information available
Material: Plastic
Model: 1000, 1000NSD
Procedure: General Surgery
Product Color: Transparent
Product Type: Towel Drape
Product Type Free Format: Drape
Product Use: Surgical Sheet
Sterile: No, Yes
Therapeutic Area and Conditions: General Surgery
Units per Pack: 10

Dimensions and Classifications

Overall Length (Imperial): 11 in, 17 in
Overall Length (Metric): 28 cm, 45 cm
Overall Width (Imperial): 11 in, 17 in
Overall Width (Metric): 30 cm, 43 cm

3M™ Steri-Drape™ Instrument Pouch

Typical properties

Accessories: Bags and Pouches
Cladimed Code: E51CF
Factory ISO Certification: No ISO Certification information available
Material: Plastic
Model: 1018, 1018L, 9097
Procedure: General Surgery
Product Color: Transparent
Product Type: Instrument Pouch, Instrument Pouch Pack
Product Type Free Format: Drape
Product Use: Accessory
Sterile: Yes
Therapeutic Area and Conditions: All Surgeries
Units per Pack: 10 , 100

Dimensions and Classifications

Overall Length (Imperial): 7 in, 10 in, 13 in
Overall Length (Metric): 18 cm, 25 cm, 29 cm, 30 cm, 33 cm, 38 cm
Overall Width (Imperial): 11 in, 15 in, 18 in
Overall Width (Metric): 17 cm, 18 cm, 30 cm, 33 cm, 38 cm, 47 cm

3M™ Medical Tape, 1522

Details

Acrylic Adhesive
Fluid Resistant
Good Processability

Typical properties

Adhesive Material: Acrylate
Adhesive Type: Acrylic/Acrylate
Backing Caliper: 3 mil
Backing Caliper (Metric): 80 Micron
Backing Material: Polyethylene
Backing Thickness (Imperial): 3 mil
Backing Thickness (Metric): 80 Micron
Brands: 3M™
Breathable: No
Conformability: Medium
Factory ISO Certification: No ISO Certification information available
Fluid Resistance Backing/Carrier: Yes
Hypoallergenic: No
Liner Caliper (Metric): 110 Micron
Liner Caliper (mils): 4.5 mil
Liner Color: White
Liner Material: Paper
Liner Weight: 80.0 lb.
Liner Weight (Metric): 130 g/m²
Material: Polyethylene
Maximum Length (Metric): 503 m
Maximum Width Capacity: 48 in
Maximum Width Capacity (Metric): 1220 mm
Printable Backing: No
Product Color: Transparent
Product Type: Double Sided Tape
Product Usage: Adhesion to Skin, Adhesion to Substrate
Sterilization Method: Ethylene Oxide (EO), Gamma
Tape Color: Transparent
Tape Total Caliper: 6.3 mil
Tape Total Caliper (Metric): 160.0 Micron
Tape Type: Double-sided Polyethylene Tape
eClass 14 Classification Group: 34180101

Dimensions and Classifications

Overall Thickness (Imperial): 34 mil
Overall Thickness (Metric): 0.16 mm
Overall Width (Imperial): 11 in, 48 in
Overall Width (Metric): 27.94 cm, 121.92 cm

3M™ Steri-Drape™ Large Ophthalmic Sheet with Aperture and 2 Pouches, 1065B, 14/Case 2 Carton/Case

3M ID 7100246032 UPC 50707387807486

Typical properties

Accessories: Aperture, Bags and Pouches
Additional Drapes: Sheet
Brands: Steri-Drape™
Cladimed Code: E51BD01
Factory ISO Certification: No ISO Certification information available
Incise Area Width (Metric): 12.5 cm
Loophole Length (Metric): 6 cm
Loophole Width (Metric): 3 cm
Material: Fabric
Model: 1065B
Procedure: EENT
Product Color: Blue
Product Type: Ophthalmic Sheet
Product Type Free Format: Drape
Product Use: EENT
Sterile: Yes
Therapeutic Area and Conditions: Ophthalmic
Units per Pack: 14

Dimensions and Classifications

Overall Length (Imperial): 62 in
Overall Length (Metric): 158 cm
Overall Width (Imperial): 108 in
Overall Width (Metric): 274 cm

3M™ Micropore™ Tan Surgical Tape, 1533 Series

Details

Breathable paper tape
Conformable
No made with natural rubber latex
Tan color

Typical properties

Brands: Micropore™
Factory ISO Certification: No ISO Certification information available
Hypoallergenic: Yes
IV Related Condition Type: CVC Dialysis, CVC Implanted Port, CVC Tunneled, PIV
Material: Paper
Product Color: Nude
Product Type: Medical Tape, Surgical Tape
Units per Pack: 6 , 12 , 24

Dimensions and Classifications

Overall Length (Imperial): 10 yd
Overall Length (Metric): 9.1 m
Overall Width (Imperial): 0.5 in, 1 in, 2 in
Overall Width (Metric): 1.27 cm, 2.54 cm, 5.08 cm

3M™ DuraPrep™ Surgical Solution

Typical properties

Antiseptic Agent: Iodine Povacrylex/IPA

Application: Skin Preparation

Brands: DuraPrep™

Factory ISO Certification: No ISO Certification information available

Model: 8630, 8635

Product Type: Applicator

Product Use: Surgical

eClass 14 Classification Group: 34210190

3M™ PRESS-ON™ Prism, 90-10000 Series

Typical properties

Brands: PRESS-ON™

Catalog Number: 90-10600,90-10500,90-10800,90-10700,90-10900,90-14000,90-13000,90-11000,90-12000,90-12500,90-10200,90-11200,90-10100,90-10400,90-11500,90-10300,90-13500

Conformability: High

Diopter: 1.00, 10.00, 12.00, 15.00, 2.00, 20.00, 25.00, 3.00, 30.00, 35.00, 4.00, 40.00, 5.00, 6.00, 7.00, 8.00, 9.00

Factory ISO Certification: No ISO Certification information available

Hypoallergenic: No

Latex: No

Printable Backing: No

Product Type: Prism

Product Usage: Medical Device

3M™ Steri-Gas™ EO Gas Cartridges, 8-170

3M ID 7100044559 UPC 50707387495539

Details

System offers easy, cost-effective and efficient sterilant for ethylene oxide sterilization

Precise usage of EO with single-dose cartridge means no sterilant waste

With Steri-Gas cartridges, operators have no bulky, heavy gas tanks to handle, and no hoses

Typical properties

Brands: Steri-Gas™

Compatibility: 8XL, GS8, GS8X

Factory ISO Certification: No ISO Certification information available

For Use With: 8XL, GS8-1D, GS8-2D

Model: 8-170

Product Type: Sterilant

Sterilization Method: Ethylene Oxide (EO)

eClass 14 Classification Group: 34419090

3M™ Littmann® Stethoscope Spare Parts Kit, Lightweight II S.E.

Details

Contains one tunable diaphragm and rim assembly for the stethoscope chestpiece

Contains one non-chill bell sleeve

Typical properties

Brands: Littmann®

Cladimed Code: K50BE02

Diaphragm Diameter (Imperial): 2.125 in

Diaphragm Diameter (Metric): 5.4 cm

Factory ISO Certification: No ISO Certification information available

Kit Includes: Snap Tight Soft-Sealing Eartips - Small, Tunable Rim/Diaphragm Assembly

Model: Lightweight II S.E.

Product Color: Black, Light Brown

Product Type: Spare Parts Kit

Units per Pack: 10

eClass 14 Classification Group: 34340191

FUTURO™ Custom Pressure Strap 45980ENR, Adjustable

3M ID 70007015988 UPC 00051131199156

Details

Applies firm-stabilizing, consistent pressure on elbow tendons affected by symptoms of tendonitis
Soothing gel pad delivers targeted pressure
Zoned pressure can be easily increased or decreased without having to adjust the whole strap
Smooth edges feel

Typical properties

Body Part: Elbow
Brands: FUTURO™
Condition: Arthritis, Golfer's Elbow, Pinched Nerve, Sprains, Strains, Swelling, Tendonitis, Tennis Elbow
Factory ISO Certification: No ISO Certification information available
Fit Range: 7" to 14"
Product Color: Black
Product Type: Strap
Product Use: During Strong Activity, General Support, General Support for Athletic Activity, Moderate/Occasional Pain, Post Cast, Prevention, Recovery
Size: Adjustable
Sizes Available: One Size - Adjustable
Support Level: Firm
Support and Compression Level: Firm
Type: Wrap around
Where to Measure: Measure around forearm below elbow.
eClass 14 Classification Group: 34200201

3M™ Littmann® Stethoscope Spare Parts Kit, Classic III™, Cardiology IV™ and CORE

Typical properties

Brands: Littmann®

Cladimed Code: K50BE02

Diaphragm Diameter (Imperial): 1.75 in

Diaphragm Diameter (Metric): 4.4 cm

Factory ISO Certification: No ISO Certification information available

Kit Includes: Nonchill Bell Sleeve, Snap Tight Soft-Sealing Eartips - Small, Tunable Single Piece Diaphragm - Adult, Tunable Single Piece Diaphragm - Pediatric

Model: Classic III™

Product Color: Black, Gray

Product Type: Spare Parts Kit

Units per Pack: 10

eClass 14 Classification Group: 34340191

3M™ Scotchpak™ Release Liner, 1022

Details

Transparent
Excellent chemical stability
Fluoropolymer release coating applied to one side
Occlusive

Typical properties

Brands: Scotchpak™
Factory ISO Certification: No ISO Certification information available
eClass 14 Classification Group: 15360503

Dimensions and Classifications

Overall Length (Imperial): 1000 yd
Overall Length (Metric): 914.4 m
Overall Width (Imperial): 8.5 in, 9 in
Overall Width (Metric): 21.59 cm, 22.86 cm

3M™ Medical Tape, 1509

Details

Tackified Acrylic Adhesive
Fluid Resistant
Good Processability
Heavy liner for easy use

Typical properties

Adhesive Material: Acrylate
Adhesive Type: Acrylic/Acrylate (Tack)
Backing Caliper: 3 mil
Backing Caliper (Metric): 80 Micron
Backing Material: Polyethylene
Backing Thickness (Imperial): 3 mil
Backing Thickness (Metric): 80 Micron
Brands: 3M™
Breathable: No
Conformability: Medium
Factory ISO Certification: No ISO Certification information available
Fluid Resistance Backing/Carrier: Yes
Hypoallergenic: No
Liner Caliper (Metric): 110 Micron
Liner Caliper (mils): 4.5 mil
Liner Color: White
Liner Material: Paper
Liner Weight: 80.0 lb.
Liner Weight (Metric): 130 g/m²
Material: Polyethylene
Maximum Length (Metric): 548 m
Maximum Width Capacity: 48 in
Maximum Width Capacity (Metric): 1220 mm
Printable Backing: No
Product Color: Transparent
Product Type: Double Sided Tape
Product Usage: Adhesion to Skin, Adhesion to Substrate
Sterilization Method: Ethylene Oxide (EO), Gamma
Tape Color: Transparent
Tape Total Caliper: 4.9 mil
Tape Total Caliper (Metric): 120.0 Micron
Tape Type: Double-sided Polyethylene Tape
eClass 14 Classification Group: 34180101

Dimensions and Classifications

Overall Thickness (Imperial): 3.8 mil
Overall Thickness (Metric): 0.12 mm
Overall Width (Imperial): 48 in
Overall Width (Metric): 121.92 cm

3M™ Mount

Typical properties

Brands: 3M™

Cladimed Code: F59ZZ99,F59AB99

Clinical Area: OR, PACU, Pre-op

Clinical Sub-Area: Labor & Delivery, Obstetrics and Gynaecology, Orthopedics,
Post Anesthetic Care Unit

Factory ISO Certification: No ISO Certification information available

Hardware: Accessory

Model: 90074, 90079, 90080, 90096

Product Type: Accessory

Quantity: 1 each

Units per Pack: 1

Dimensions and Classifications

Overall Height (Imperial): 1 in, 2 in, 2.25 in, 4.5 in

Overall Height (Metric): 2.5 cm, 5.1 cm, 5.7 cm, 11.4 cm

Overall Length (Metric): 5.1 cm

Overall Width (Imperial): 2 in, 2.25 in, 3.75 in, 4.5 in

Overall Width (Metric): 3.8 cm, 5.7 cm, 9.5 cm, 11

3M™ Curot Tips™ Disinfecting Cap for Male Luers, CM5-200

Details

Disinfects in 1 minute and provides a physical barrier to contamination between accesses for up to 7 days if not removed
Twists on easily and stays securely in place
Unique design shields excess alcohol from entering lumen while providing sufficient flow

Typical properties

Boxes per Case: 10.0
Brands: Curot Tips™
Catalog Number: CM5-200R,CM5-200BNS,CM5-200
Compatible Connector: Male Luers
Condition: I.V. Related
Factory ISO Certification: No ISO Certification information available
Latex: No
Package Contents: Strips
Product Type: Disinfecting Cap
Shelf Life: 3 Year
Units per Box: 200.0
Units per Case: 2000.0
eClass 14 Classification Group: 34221209

TIELLE™ Lite Dressing, MTL308, 8 cm x 15 cm, 10/Ct, 5 Cts/Cs

3M ID 7100237342 UPC 15051978000709

Details

Non-adherent wound contact layer that allows the free passage of exudate
Minimizes adherence to the wound bed or sutures/staples

Typical properties

Boxes per Case: 5.0

Brands: Tielle™

Catalog Number: MTL308

Factory ISO Certification: No ISO Certification information available

Units per Case: 50.0

Units per Pack: 10

eClass 14 Classification Group: 34210409

Dimensions and Classifications

Overall Length (Metric): 15 cm

Overall Width (Imperial): 3.15 in

Overall Width (Metric): 8 cm

BIOSORB™ Gelling Fibre Dressing BGF0505U, 5 cm x 5 cm, 10 ea/bx

3M ID 7100238813 UPC 15051978008422

Details

Forms a gel which helps to create a moist wound environment
Conformable
Maintains shape and integrity
Protects peri-wound skin from maceration¹

Typical properties

Brands: Biosorb™
Factory ISO Certification: No ISO Certification information available
eClass 14 Classification Group: 34210402

Dimensions and Classifications

Overall Length (Metric): 5 cm
Overall Width (Metric): 5 cm

3M™ Steri-Drape™ Roll Prep Drape, 1000

Typical properties

Accessories: Miscellaneous
Additional Drapes: Sheet
Clinical Area: Surgery
Factory ISO Certification: No ISO Certification information available
Material: Plastic
Model: 1000DISP, 1000NSR
Procedure: General Surgery
Product Type: Roll Prep Drape
Product Type Free Format: Drape
Product Use: Surgical Sheet
Sterile: No
Units per Pack: 1 , 8

Dimensions and Classifications

Overall Length (Imperial): 25 yd
Overall Length (Metric): 22 m
Overall Width (Imperial): 11 in
Overall Width (Metric): 30 cm

3M™ Steri-Drape™ Isolation Drape, 1010 Series

Typical properties

Accessories: Bags and Pouches, Miscellaneous
Cladimed Code: E51BA03
Factory ISO Certification: No ISO Certification information available
Incise Area Length (Metric): 50 cm
Incise Area Width (Metric): 25 cm
Material: Plastic
Model: 1014, 1017
Procedure: Orthopedic
Product Color: Transparent
Product Type: Isolation Drape
Product Type Free Format: Drape
Product Use: Orthopedics
Sterile: Yes
Therapeutic Area and Conditions: Orthopaedic
Units per Pack: 5

Dimensions and Classifications

Overall Length (Imperial): 126 in
Overall Length (Metric): 320 cm
Overall Width (Imperial): 84 in
Overall Width (Metric): 214 cm

3M™ Steri-Drape™ Adhesive Aperture Drape, 9000 Series

Typical properties

Accessories: Aperture
Additional Drapes: Sheet
Cladimed Code: E51BA99
Factory ISO Certification: No ISO Certification information available
Loophole Length (Metric): 6 cm, 12 cm, 15 cm
Loophole Width (Metric): 8 cm, 16 cm
Material: Fabric
Model: 9029, 9030, 9031, 9050
Procedure: General Surgery
Product Color: Blue
Product Type: Aperture Drape
Product Type Free Format: Drape
Product Use: General Surgery, Procedure Specific, Surgical Sheet
Therapeutic Area and Conditions: Day Surgery, General Surgery, Urology
Units per Pack: 10 , 20 , 25 , 40

Dimensions and Classifications

Overall Length (Imperial): 30 in, 47 in, 72 in, 118 in
Overall Length (Metric): 75 cm, 76 cm, 120 cm, 183 cm, 300 cm
Overall Width (Imperial): 29 in, 59 in, 60 in, 89 in
Overall Width (Metric): 75 cm, 150 cm, 152 cm, 228 cm

3M™ Medical Foam Tape, 1770 Series

Details

Tackified Acrylic Adhesive
Fluid resistant
Adheres to High Surface Energy Substrates
Good Processability

Typical properties

Adhesive Material: Acrylate
Adhesive Type: Acrylic/Acrylate, Acrylic/Acrylate (Tack)
Backing Caliper: 20 mil, 63 mil
Backing Caliper (Metric): 510 Micron, 1600 Micron
Backing Material: Polyolefin Foam
Backing Thickness (Imperial): 20 mil, 63 mil
Backing Thickness (Metric): 510 Micron, 1600 Micron
Brands: 3M™
Breathable: No
Catalog Number: 1772,1774W,1774T
Conformability: High, Low
Factory ISO Certification: No ISO Certification information available
Fluid Resistance Backing/Carrier: Yes
Hypoallergenic: No
Latex: No
Liner Caliper (Metric): 120 Micron, 150 Micron
Liner Caliper (mils): 4.9 mil, 6 mil
Liner Color: White
Liner Material: Paper
Liner Weight: 83.0 lb.,63.0 lb.
Liner Weight (Metric): 103 g/m², 135 g/m²
Material: Polyolefin Foam
Maximum Length (Metric): 73 m, 366 m
Maximum Width Capacity: 48 in
Maximum Width Capacity (Metric): 1220 mm
Printable Backing: Yes
Product Color: Tan, White
Product Type: Medical Tape
Product Usage: Adhesion to Skin
Sterilization Method: Ethylene Oxide (EO), Gamma
Tape Color: Tan, White
Tape Total Caliper: 22.0 mil,65.0 mil
Tape Total Caliper (Metric): 560.0 Micron,1650.0 Micron
Tape Type: Single Sided Foam Tape
eClass 14 Classification Group: 34390202

Dimensions and Classifications

Overall Thickness (Imperial): 1 in, 4.4 mil, 15 mil
Overall Thickness (Metric): 0.6 mm, 1.7 mm

3M™ Medical Transfer Adhesive, 1524

Typical properties

Adhesive Material: Acrylate
Backing Material: Fiber-reinforced Adhesive Transfer Tape
Brands: 3M™
Breathable: Yes
Conformability: High
Factory ISO Certification: No ISO Certification information available
Fluid Resistance Backing/Carrier: No
Hypoallergenic: No
Latex: No
Liner Caliper (Metric): 80 Micron, 110 Micron
Liner Caliper (mils): 3 mil, 4.5 mil
Liner Color: White
Liner Material: Paper
Liner Weight: 78.0 lb., 54.0 lb.
Liner Weight (Metric): 88 g/m², 127 g/m²
Maximum Length (Metric): 366 m
Maximum Width Capacity: 48 in
Maximum Width Capacity (Metric): 1220 mm
Printable Backing: No
Product Color: Transparent
Product Type: Adhesive Transfer Tape
Product Usage: Adhesion to Skin, Adhesion to Substrate
Sterilization Method: Ethylene Oxide (EO), Gamma, Steam
Tape Color: Transparent
Tape Total Caliper: 2.5 mil
Tape Total Caliper (Metric): 60.0 Micron
Tape Type: Adhesive Transfer Tape
eClass 14 Classification Group: 15360503

Dimensions and Classifications

Overall Thickness (Imperial): 1 in, 6 mil
Overall Thickness (Metric): 0.06 mm
Overall Width (Imperial): 48 in
Overall Width (Metric): 1219.2 mm

**3M™ Medical Transfer Adhesive 1504XL, High Tack, 6 IN x 600 YD,
62#**

Liner, inc 1/16 IN ext liner each side, 1 roll/case

3M ID 7100148824 UPC 00707387784645

Details

Synthetic Rubber Adhesive
Fluid Resistant
High Tack
Aggressive Adhesion

Typical properties

Brands: 3M™
Factory ISO Certification: No ISO Certification information available
eClass 14 Classification Group: 34180101

Dimensions and Classifications

Overall Width (Imperial): 6 in
Overall Width (Metric): 152.4 mm

3M™ Kerracel™ Ag Gelling Fiber Dressing, CWL1158, 4 in x 5 in (10 cm x 12.5 cm), 10/ct, 10ct/Case

3M ID 7100253239 UPC 04054596954366

Details

Antimicrobial
A fast and powerful silver technology

Typical properties

Brands: Kerracel™
eClass 14 Classification Group: 34210402

FUTURO™ Ankle Performance Stabilizer, 46645ENR Adjustable

3M ID 70007016804 UPC 00051131201514

Details

Moderate-stabilizing design offers customizable levels of compression, support and heat retention

Adjustable features provide lift and support around your arch

Side stabilizers restrict lateral mobility

Helps support stiff, sore or injured ankles

Brea

Typical properties

Body Part: Ankle

Brands: FUTURO™

Condition: Arthritis, Pinched Nerve, Plantar Fasciitis, Sprains, Strains

Factory ISO Certification: No ISO Certification information available

Fit Range: 8" to 10"

Material: Elastane, Nylon, Polyester, Polyethylene, Polyurethane

Product Color: Black

Product Type: Support

Product Use: Arch/Heel Pain, Foot, Arch & Heel Pain, General Support for

Athletic Activity, Moderate/Occasional Pain, Recovery, Strains, Weak, Sore or Injured Ankle

Size: Adjustable

Sizes Available: One Size - Adjustable

Support and Compression Level: Firm

Type: Stabilizer

Where to Measure: Measure around ankle.

eClass 14 Classification Group: 34200201

FUTURO™ Sport Adjustable Elbow Support, 09038EN

3M ID 70005273670 UPC 00051131201422

Details

Provides moderate support to weak, sore muscles and joints
Adjustable straps for customizable support
Flexible materials promote a full range of motion
Wear on either arm for versatility
Provides support for stiff, weak, sore, and injured elbows
Supp

Typical properties

Body Part: Elbow, Elbow/Forearm
Brands: FUTURO™
Condition: Arthritis, Golfer's Elbow, Pinched Nerve, Sprains, Strains, Swelling, Tendonitis, Tennis Elbow
Factory ISO Certification: No ISO Certification information available
Fit Range: 6.5" to 13.5"
Product Color: Black
Product Type: Wrap around
Product Use: During Strong Activity, General Support for Athletic Activity, Moderate/Occasional Pain, Post Cast, Prevention, Recovery
Size: Adjustable
Sizes Available: One Size - Adjustable
Support Level: Moderate
Support Level Description: Provides adjustable levels of compression, support and therapeutic heat retention to help relieve symptoms associated with strains, sprains, arthritis and muscle pain. Comfortable for all day wear or for specific activities.
Support and Compression Level: Moderate
Type: Wrap around
Where to Measure: Measure around elbow.
eClass 14 Classification Group: 34200201

FUTURO™ For Her Wrist Support

3M ID CBGBLW011043 UPC 00051131201682

Details

Provides moderate support to injured wrists
Helps provide relief from symptoms associated with Carpal Tunnel Syndrome, strains, sprains and other wrist injuries
Plush gel cushioning pad in palm enhances comfort
Sleeve design for easy on, easy off
Light

Typical properties

Body Part: Wrist
Brands: FUTURO™
Condition: Arthritis, Carpal Tunnel Syndrome, Pinched Nerve, Repetitive Stress Injury, Sprains, Strains, Swelling, Tendonitis, Thumb Hyperextension
Factory ISO Certification: No ISO Certification information available
Fit Range: 5.5" to 7"
Material: Aluminum, Nylon, Polyester, Polyurethane, Silicone, Spandex
Product Color: Gray
Product Type: Brace
Product Use: During Strong Activity, General Support, General Support for Athletic Activity, Moderate/Occasional Pain, Prevention, Recovery, Sore, Weak or Injured Wrist, Sprains, Strains, Symptoms of Carpal Tunnel Syndrome
Size: Adjustable
Sizes Available: One Size - Adjustable, Right Hand
Support Level: Moderate
Support and Compression Level: Moderate
Type: Brace
Where to Measure: Measure around wrist at smallest point.
eClass 14 Classification Group: 34200201

FUTURO™ Sport Hinged Knee Brace

3M ID CBGBLW011055 UPC 00051131201590

Details

Improved Size range. Fits 16" - 22"
Provides firm compression to weak, sore muscles and joints
Side hinges help prevent lateral motion
Wraparound style for easy on, easy off
Adjustable straps for customizable support
Flexible materials promote heat r

Typical properties

Body Part: Knee
Brands: FUTURO™
Condition: Patella Tracking, Sprains, Strains
Factory ISO Certification: No ISO Certification information available
Fit Range: 16" to 22"
Material: Acetal Plastic (POM), Aluminum, EVA, Neoprene, Nylon, Polypropylene
Product Color: Black
Product Type: Brace, Wrap around
Product Use: Medial/Lateral Support, Sprains, Strains, Weak, Sore Muscles & Injured Knees
Size: Adjustable
Sizes Available: One Size - Adjustable
Support Level: Firm
Support and Compression Level: Firm
Type: Brace
Where to Measure: Measure 3" above kneecap.
eClass 14 Classification Group: 34200201

3M™ Buf-Puf™ Regular Facial Sponge, 910-06, 1 ct.

3M ID 70071371606 UPC 00051131910010

Details

For oily or combination skin

Use every day with your favorite soap or cleanser

Lifts off dry, dulling skin cells

Gently cleanses away makeup, dirt and excess oil

Leaves skin smooth and soft, perfectly prepped for moisturizers, makeup, and sunless tann

Typical properties

Brands: 3M™

Factory ISO Certification: No ISO Certification information available

Package Contents: 1/pack

Product Color: White

eClass 14 Classification Group: 29110000

Nexcare™ Waterproof Bandages

3M ID COBBLW014047 UPC 00051131997608

Details

Waterproof design stays on skin in the bath, shower or pool
Covers and protect cuts, scrapes and blisters
360-degree seal around the pad offers exceptional protection against water, dirt, and germs
Leaves minimal adhesive residue on skin when removed

Typical properties

Application: Blister, Caregivers, Hard-to-Cover Areas, Kids, Sports, Waterproof
Brands: Nexcare™
Factory ISO Certification: No ISO Certification information available
Material: Clear Film, Plastic
Package Contents: 50/Pack,8 Pack,20 pack,100 Pack
Product Color: Transparent
Product Type: Bandage
Properties: Breathable, Waterproof
Size: Assorted
Sizes Available: 100 ct. Asst: 40 at .88" x 1.06" (22mm x 26mm), 30 at 1.25" x 2.5" (31mm x 63mm), 30 at 1.06" x 2.25" (26mm x 57mm); 50 ct. Asst: 20 at .88" x 1.06" (22mm x 26mm), 15 at 1.25" x 2.5" (31mm x 63mm), 15 at 1.06" x 2.25" (26mm x 57mm); 20 ct. Asst: 6 at 1.25" x 2.5" (31mm x 63mm), 8 at 1.06" x 2.25" (26mm x 57mm), 6 at .88" x 1.1" (22mm x 27mm); 20 ct. One Size: 1.06" x 2.25" (26mm x 57mm); Knee & Elbow: 2.38" x 3.5" (60mm x 88mm)
Solution for: Knees/Elbows, Sports, Waterproof
Waterproof: Yes
Wound Type: Cuts / Scrapes / Abrasions
eClass 14 Classification Group: 34400201

Dimensions and Classifications

Overall Length (Metric): 57 mm
Overall Width (Metric): 27 mm

ACE™ Brand Compression Knee Support

3M ID COBBLW014114 UPC 00051131203785

Details

Stretchy design conforms to your knee for comfort and mild compression
Breathable knit material is an innovative combination of elastic and neoprene blend materials that releases moisture
Soft, breathable, neoprene blend panel stitched around the knee j

Typical properties

Body Part: Knee
Brands: ACE™
Catalog Number: 907002,907001
Condition: Sprains, Strains, Swelling
Factory ISO Certification: No ISO Certification information available
Fit Range: S/M fits: 11" to 15"
L/XL fits: 16" to 20"
Latex-free: No
Material: Neoprene, Nylon, Polyester, Polyurethane, Rubber, Spandex
Performance Zone Category: Return to Activity
Product Color: Black
Product Type: Support
Properties: Breathable, Reusable
Size: Large/X-Large, Small/Medium
Sizes Available: S/M, L/XL
Support Level: Mild
Type: Support
Where to Measure: Measure around kneecap while standing.
eClass 14 Classification Group: 34200201

ACE™ Brand Compression Ankle Support

3M ID COBBLW014166 UPC 00051131212213

Details

Designed to provide comfortable, even compression
Breathable, dual-stretch power knit material for comfort
Anatomical shape for optimal fit and joint protection
Not made with natural rubber latex
#1 Pharmacist Recommended Brand of Braces & Supports* (

Typical properties

Body Part: Ankle
Brands: ACE™
Factory ISO Certification: No ISO Certification information available
Fit Range: S/M fits 8" to 9"
L/XL fits 9" to 10"
Latex-free: Yes
Material: Nylon, Polyester, Spandex
Package Contents: 1/pack
Performance Zone Category: Injury Care
Product Color: Gray
Product Type: Support
Properties: Breathable, Non Latex Containing, Reusable, Washable
Size: Large/X-Large, Small/Medium
Sizes Available: Large/X-Large, Small/Medium
Support Level: Mild
Where to Measure: Measure around ankle.
eClass 14 Classification Group: 34200201

ACE™ Cold/Hot Compress Back Wrap 203960

3M ID 70007019832 UPC 00051131204041

Details

Convenient wrap design lets you experience relief when you're seated or on the move

Stretchy, neoprene-blend fabric is comfortable against your skin

Adjustable design provides a custom fit

Insulating design retains hot or cold temperatures for relief

Typical properties

Body Part: Back

Brands: ACE™

Factory ISO Certification: No ISO Certification information available

Injury: Arthritis, Bumps/Bruises, Insect Bites, Muscle Aches/Cramps, Sprains & Strains, Swelling

Performance Zone Category: Injury Care

Product Color: Blue

Product Type: Hot/Cold Therapy

Properties: Adjustable, Comfort Touch, Non Latex Containing, Reusable

Size: Adjustable

Sizes Available: One Size Fits Most

Type: Hot/Cold Therapy

eClass 14 Classification Group: 34400201

Nexcare™ Advanced Waterproof Bandages AWB-10, 3 sizes

3M ID 70005296200 UPC 00051131204713

Details

Waterproof design stays on skin in the bath, shower or pool
Gel pad helps protect cuts, scrapes, blisters and minor burns
Diamond shape provides a better seal around the pad
Breathable, stretchy construction moves with you
Ultra-thin, clear bandage of

Typical properties

Brands: Nexcare™

Factory ISO Certification: No ISO Certification information available

Package Contents: 10 Pack

Product Color: Transparent

Product Type: Bandage

Size: Assorted

Sizes Available: 10 ct. Asst: 2 at 1" x 2.81" (25mm x 71mm), 3 at 1.25" x 2.5" (31mm x 63mm), 5 at 1.06" x 2.25" (26mm x 57mm)

Solution for: Advanced Healing, Blister, Cushioning, Heels/Toes, Waterproof
eClass 14 Classification Group: 34400201

Nexcare™ Advanced Healing Waterproof Hydrocolloid Pads, AHD-06, 6 ct. 3 in x 4 in

3M ID 70007005856 UPC 00051131215689

Details

Waterproof design
Gel pad helps protect minor burns, cuts, scrapes and blisters
Diamond shape
Breathable, stretchy construction moves with you
Thin, clear bandage offers a minimal feel and is virtually invisible
Allows for easy application with one h

Typical properties

Application: Waterproof
Brands: Nexcare™
Factory ISO Certification: No ISO Certification information available
Package Contents: 3 Pack
Package Quantity: 6
Product Color: Transparent
Product Type: Pad with Adhesive
Properties: Non-Stick Pad
Solution for: Advanced Healing, Blister, For Large Wounds, Waterproof
Wound Type: Cuts / Scrapes / Abrasions, Minor Burns
eClass 14 Classification Group: 34210405

Dimensions and Classifications

Overall Length (Imperial): 3.93 in
Overall Width (Imperial): 2.96 in

Nexcare™ Opticlude™ Orthoptic Eye Patch 1539, Regular, 3.18 in x 2.18 in (81 mm x 55.5 mm) 20 patches/box

3M ID 70005177376 UPC 00051131000230

Details

Breathable backing for all-day comfort

Non-stick pad

Gentle adhesive

Contoured for comfort

Hypoallergenic adhesive

Designed for use in treating amblyopia (lazy eye) and strabismus (crossed eyes), as part of your doctor recommended treatment plan

Siz

Typical properties

Age Group: Adult

Application: Sensitive Skin

Brands: Nexcare™

Condition: Lazy Eye/Crossed Eyes

Factory ISO Certification: No ISO Certification information available

Latex: No

Package Contents: 20/Pack

Package Quantity: 20

Patches per Box: 20

Product Color: Tan

Product Type: Eye Patch

Properties: Absorbent, Breathable

Size: One Size Fits Most

Sizes Available: Regular & Junior

eClass 14 Classification Group: 34180405

Dimensions and Classifications

Overall Length (Imperial): 3.25 in

Overall Length (Metric): 82 mm

Overall Width (Imperial): 2.24 in

Overall Width (Metric): 57 mm

Futuro™ Shoulder Hot/Coldwrap 46822ENR, Adjustable

3M ID 70007042339 UPC 00051131221697

Details

Freeze the two gel inserts for at least two hours for a shoulder ice pack
Microwave the gel inserts for 20 seconds for heat therapy
Easy to use design provides targeted relief
Stretchy neoprene-blend materials delivers a contoured fit
Adjustable strap

Typical properties

Body Part: Shoulder
Brands: FUTURO™
Factory ISO Certification: No ISO Certification information available
Size: Adjustable
Sizes Available: One Size - Adjustable
Type: Hot/Cold Therapy
eClass 14 Classification Group: 34400201

FUTURO™ Sport Ankle Support

3M ID CBGBLW011005 UPC 00051131201439

Details

Moderate-support design offers customizable levels of compression and support
Helps support stiff, sore, or injured ankles
Provides soothing heat retention
Wraparound design for a personalized fit
Wear on either ankle for versatility
Fits comfortably

Typical properties

Body Part: Ankle
Brands: FUTURO™
Condition: Arthritis, Pinched Nerve, Plantar Fasciitis, Sprains, Strains, Swelling, Tendonitis
Factory ISO Certification: No ISO Certification information available
Fit Range: 7" to 11"
Product Color: Black
Product Type: Wrap around
Product Use: Arch/Heel Pain, Foot, Arch & Heel Pain, General Soreness, General Support for Athletic Activity, Moderate/Occasional Pain, Recovery, Sprains, Support for Arthritic Joints, Swelling, Tendonitis
Size: Adjustable
Sizes Available: One Size - Adjustable
Support Level: Moderate
Support Level Description: Provides adjustable levels of compression, support and therapeutic heat retention to help relieve symptoms associated with strains, sprains, arthritis and muscle pain. Comfortable for all day wear or for specific activities.
Support and Compression Level: Moderate
Type: Wrap around
Where to Measure: Measure around ankle.
eClass 14 Classification Group: 34200201

FUTURO™ Performance Comfort Elbow Support

3M ID CBGBLW011029 UPC 00051131200630

Details

Moderate-support design offers customizable levels of compression and support
Easy-to-use comfort straps for personalized adjustment
Breathable materials allow air to circulate and help keep skin dry
Convenient design can be worn on either elbow
Suppo

Typical properties

Body Part: Elbow
Brands: FUTURO™
Condition: Arthritis, Golfer's Elbow, Pinched Nerve, Sprains, Strains, Swelling, Tendonitis, Tennis Elbow
Factory ISO Certification: No ISO Certification information available
Fit Range: 6.5" to 13.5"
Material: Nylon, Polyester, Polyurethane, Spandex
Product Color: Black
Product Type: Support
Product Use: During Strong Activity, General Support for Athletic Activity, Moderate/Occasional Pain, Post Cast, Prevention, Recovery
Size: Adjustable
Sizes Available: One Size - Adjustable
Support Level: Moderate
Support and Compression Level: Moderate
Type: Wrap around
Where to Measure: Measure around elbow.
eClass 14 Classification Group: 34200201

FUTURO™ Sport Knee Support

3M ID CBGBLW011054 UPC 00051131201408

Details

Provides moderate compression to weak and sore muscles and joints
Three adjustable straps for customizable support
Flexible materials promote a full range of motion and heat retention
Wear on either knee for versatility
Ideal for stiff, weak, sore and

Typical properties

Body Part: Knee
Brands: FUTURO™
Condition: Arthritis, Jumper's Knee, Patella Tracking, Pinched Nerve, Runner's Knee, Sprains, Strains, Swelling, Tendonitis
Factory ISO Certification: No ISO Certification information available
Fit Range: 13" to 17.5"
Material: Neoprene, Nylon, Polyester, Spandex
Product Color: Black
Product Type: Support, Wrap around
Product Use: During Strong Activity, General Support for Athletic Activity, Medial/Lateral Support, Moderate/Occasional Pain, Patella Tracking, Prevention, Recovery, Tendonitis, Weak, Sore Muscles & Injured Knees
Size: Adjustable
Sizes Available: One Size - Adjustable
Support Level: Moderate
Support and Compression Level: Moderate
Type: Wrap around
Where to Measure: Measure around knee.
eClass 14 Classification Group: 34200201

3M™ Buf-Puf™ Gentle Facial Sponge, 915-06, 1 ct.

3M ID 70071371614 UPC 00051131185036

Details

Ideal for dry skin

Use every day with your favorite soap or cleanser

Lifts off dry, dulling skin cells

Gently cleanses away makeup, dirt and excess oil

Leaves skin smooth and soft, perfectly prepped for moisturizers, makeup, and sunless tanning

Derma

Typical properties

Brands: 3M™

Factory ISO Certification: No ISO Certification information available

Package Contents: 1/pack

Product Color: Orange

Product Type: Facial & Body Sponge

eClass 14 Classification Group: 29110000

Nexcare™ Durable Cloth First Aid Tape

3M ID COBBLW014017 UPC 00051131653016

Details

From the #1 leader in U.S. hospital tapes
Comfortably secures gauze and dressings
Strong adhesive stays on, even during exercise
Conforms comfortably to fingers, toes, elbows, ankles and more
Woven material delivers strong support
Breathable design p

Typical properties

Brands: Nexcare™
Factory ISO Certification: No ISO Certification information available
Material: Cloth
Product Color: White

Dimensions and Classifications

Overall Length (Imperial): 6 yd, 10 yd, 360 in
Overall Width (Imperial): 0.75 in, 1 in
Overall Width (Metric): 19.05 mm

Nexcare™ All-in-One Adhesive Pad H3564, 2 3/8 in x 4 in (6 cm x 10 cm)

3M ID 70005112944 UPC 00051131835566

Details

Provides protection to minor burns, scrapes, cuts and abrasions
Absorbent pad doesn't stick to your wound
Strong adhesive stays put for up to 7 days
Low-profile design conforms comfortably to your skin
Breathable design provides lasting comfort
Great

Typical properties

Application: Sensitive Skin
Brands: Nexcare™
Factory ISO Certification: No ISO Certification information available
Hospital Name: Medipore H
Material: Plastic
Product Color: White
Product Type: Pad with Adhesive
Properties: Repositionable
Solution for: Post-Surgical / Sutures / Stitches, Stays on Longer
Wound Type: Cuts / Scrapes / Abrasions, Minor Burns, Post-Surgical Incisions
eClass 14 Classification Group: 34400201

Nexcare™ Tegaderm™ +Pad Transparent Dressing

3M ID COBBLW014046 UPC 00051131948914

Details

#1 hospital brand with absorbent pad
Absorbent pad wicks fluid and doesn't stick to your wound
Provides protection to minor burns, scrapes, cuts, blisters and abrasions
Helps protect fragile, reddened and post-surgical skin
Allows moisture to escape,

Typical properties

Application: Caregivers, Extended Wear, Hard-to-Cover Areas, Post-Surgical /
Sutures / Stitches, Sports, Waterproof
Brands: Nexcare™
Factory ISO Certification: No ISO Certification information available
Hospital Name: Tegaderm + Pad Dressing
Material: Plastic
Package Contents: 3 Pack, 1 Pack
Product Color: Transparent
Product Type: Pad with Adhesive
Properties: Absorbent, Breathable, Waterproof
Sizes Available: 5 ct. (Cat# H3584): Dressing Size: 2.375" x 4"; 3 ct. Oval (Cat#
H3587): Dressing Size: 3.5" c 4/125"
Solution for: Waterproof
Waterproof: No, Yes
Wound Type: Blisters, Cuts / Scrapes / Abrasions, Minor Burns, Post-Surgical
Incisions
eClass 14 Classification Group: 34400201

Dimensions and Classifications

Overall Length (Imperial): 0.39 in, 4 in, 6 in, 8 in
Overall Length (Metric): 10 cm, 101.6 mm
Overall Width (Imperial): 2.36 in, 2.375 in, 3.5 in, 6 in
Overall Width (Metric): 6 cm, 58.42 mm

ACE™ Brand Instant Cold Pack

3M ID COBBLW014108 UPC 00051131209374

Details

Convenient, portable design for immediate relief
Cold therapy is ideal for sprains, strains, bumps, bruises and more
One-time use
Store one in backpack, handbag, office and duffel bag
Great for use in the home, camping trips, sports events and more
A

Typical properties

Body Part: Multi-Purpose
Brands: ACE™
Factory ISO Certification: No ISO Certification information available
Ideal For: Basketball, Cross training, Football, Golf, Hockey, Soccer, Tennis, Volleyball
Injury: Bumps/Bruises, Carpal Tunnel Syndrome, Insect Bites, Sprains & Strains, Swelling, Toothaches
Product Color: White
Product Type: Hot/Cold Therapy
Properties: Adjustable
Size: Adjustable
Sizes Available: One Size Fits Most
Sport: Baseball, Volleyball
Type: Cold Therapy
eClass 14 Classification Group: 34400201

ACE™ Brand Dual Strap Knee Support

3M ID CBGBLWUS1377 UPC 00051131193178

Details

Soothing gel pads deliver targeted pressure on your sore tendons
Adjustable hook-and-loop straps for custom comfort
Breathable material releases excess heat for cooling comfort
Low-profile design feels less bulky, stays-in-place and conforms around you

Typical properties

Application: Securing Hot/Cold
Body Part: Knee
Brands: ACE™
Closure Method: Hook & Loop
Condition: Arthritis, Sprains, Strains, Tendonitis
Factory ISO Certification: No ISO Certification information available
Fit Range: 12.5" to 17.5"
Latex-free: Yes
Material: Neoprene, Nylon, Polyester, Polyurethane, Spandex
Product Color: Black
Product Type: Support
Product Use: Sprains & Strains, Support for Arthritic Joints, Tendonitis
Properties: Adjustable, Breathable, Gel Cushion, Non Latex Containing
Size: Adjustable
Sizes Available: One Size - Adjustable
Sport: Basketball
Support Level: Moderate
Type: Support
Where to Measure: Measure around leg below kneecap.
eClass 14 Classification Group: 34200201

FUTURO™ Comfort Ankle Support

3M ID CBGBLW011000 UPC 00051131201033

Details

4-way stretch materials and contoured design conforms to your ankle for comfort and mild compression

Helps support stiff, sore, or injured ankles

Breathable materials allow air to circulate and help keep skin dry

Soft binding around heel opening enhances

Typical properties

Body Part: Ankle

Brands: FUTURO™

Condition: Arthritis, General Soreness, Sprains, Strains, Swelling

Factory ISO Certification: No ISO Certification information available

Fit Range: SMALL fits: 10" to 12.5"
MEDIUM fits: 12.5" to 15"
LARGE fits: 15" to 17.5"

Material: Nylon, Polyester, Spandex

Package Contents: 1/pack

Product Color: Gray

Product Type: Support

Product Use: General Support, Low Impact Activity

Size: Large, Medium, Small

Sizes Available: Small,Medium,Large

Support Level: Mild

Support and Compression Level: Mild

Type: Support

Where to Measure: Measure around the heel and the instep.

eClass 14 Classification Group: 34200201

FUTURO™ Compression Glove

3M ID CBGBLW011038 UPC 00051131200401

Details

Provides mild support to aching, weak hands and wrists
Adjusts for a snug fit
Easy on, easy off design
Soft, breathable materials enhance comfort
Designed for all-day wear
Wear on either hand for versatility
Supported by our expert panel of engineer

Typical properties

Body Part: Hand
Brands: FUTURO™
Condition: Arthritis, Carpal Tunnel Syndrome, Pinched Nerve, Repetitive Stress Injury, Sprains, Strains, Swelling, Tendonitis, Thumb Hyperextension
Factory ISO Certification: No ISO Certification information available
Fit Range: S/M fits: 6.5" to 8"
L/XL fits: 8" to 9.5"
Latex-free: Yes
Material: Nylon, Polyester, Spandex
Product Color: Beige
Product Type: Glove
Product Use: Aching, Weak or Swollen Hand or Wrist, During Strong Activity, General Support for Athletic Activity, Moderate/Occasional Pain, Prevention, Recovery
Size: Large/X-Large, Small/Medium
Sizes Available: Small / Medium, Large / X-Large
Support Level: Mild
Support and Compression Level: Mild
Type: Support, Support with Straps
Where to Measure: Measure around hand, above thumb.
eClass 14 Classification Group: 34200201

FUTURO™ Performance Comfort Knee Support

3M ID CBGBLW011050 UPC 00051131200647

Details

Moderate-support design offers customizable levels of compression and support
Patella shield and gel cushioning offer extra support at your kneecap
Easy-to-use comfort straps for personalized adjustment
Breathable materials allow air to circulate and h

Typical properties

Body Part: Knee
Brands: FUTURO™
Condition: Arthritis, Jumper's Knee, Patella Tracking, Pinched Nerve, Runner's Knee, Sprains, Strains, Swelling, Tendonitis
Factory ISO Certification: No ISO Certification information available
Fit Range: 13" to 17.5"
Material: Nylon, Polyester, Polyurethane, Silicone, Spandex
Product Color: Black
Product Type: Support
Product Use: During Strong Activity, General Support for Athletic Activity, Medial/Lateral Support, Moderate/Occasional Pain, Prevention, Recovery, Weak, Sore Muscles & Injured Knees
Size: Adjustable
Sizes Available: One Size - Adjustable
Support Level: Moderate
Support and Compression Level: Moderate
Type: Wrap around
Where to Measure: Measure around knee.
eClass 14 Classification Group: 34200201

Nexcare™ Opticlude™ Orthoptic Eye Patch 1537, Junior, 2.44 in x 1.81 in (62 mm x 46 mm) 20 Patches/Box

3M ID 70005177368 UPC 00051131000223

Details

Breathable backing for all-day comfort
Non-stick pad
Gentle adhesive
Contoured for comfort
Hypoallergenic adhesive
Designed for use in treating amblyopia (lazy eye) and strabismus (crossed eyes), as part of your doctor recommended treatment plan
Siz

Typical properties

Age Group: Children
Brands: Nexcare™
Condition: Lazy Eye/Crossed Eyes
Factory ISO Certification: No ISO Certification information available
Latex: No
Package Contents: 20/Pack
Package Quantity: 20
Patches per Box: 20
Product Color: Tan
Product Type: Eye Patch
Properties: Absorbent, Breathable
Size: Junior
Sizes Available: Regular & Junior
eClass 14 Classification Group: 34180405

Dimensions and Classifications

Overall Length (Imperial): 2.5 in
Overall Length (Metric): 63.5 mm
Overall Width (Imperial): 1.87 in
Overall Width (Metric): 45.7 mm

Nexcare™ Steri-Strip™ Wound Closure

3M ID COBBLW014040 UPC 00051131641242

Details

Secures, closes and supports small cuts and wounds
Breathable design provides ventilated comfort
Leaves minimal residue on skin when removed
Hypoallergenic strips are easy on skin
Holds firmly in place
Package contents: 18ct or 30ct
Size: 1/2" x 4", 1/4

Typical properties

Adhesive Type: Acrylate
Application: Caregivers, Extended Wear, Post-Surgical / Sutures / Stitches
Brands: Nexcare™
Factory ISO Certification: No ISO Certification information available
Package Contents: 18 Pack
Product Color: Transparent, White
Product Type: Clear Dressing, Skin Closure
Properties: Breathable
Solution for: Wound Closures
Wound Type: Cuts / Scrapes / Abrasions, Post-Surgical Incisions
eClass 14 Classification Group: 34180306

Dimensions and Classifications

Overall Length (Imperial): 4 in
Overall Length (Metric): 101.6 mm
Overall Width (Imperial): 0.25 in, 0.5 in
Overall Width (Metric): 6.35 mm, 12.7 mm

ACE™ Brand Elbow Strap

3M ID COBBLW014095 UPC 00051131199927

Details

Provides moderate support for weak or injured elbow and forearm
For injuries like tennis or golfer's elbow
Adjustable hook-and-loop strap for a quick, customizable fit
Air cushion applies targeted compression
Breathable materials allow air to circulate

Typical properties

Body Part: Elbow
Brands: ACE™
Condition: Arthritis, Golfer's Elbow, Tendonitis, Tennis Elbow
Factory ISO Certification: No ISO Certification information available
Fit Range: 7" to 13"
Material: Neoprene, Nylon, Polyester, Spandex
Performance Zone Category: Return to Activity
Product Color: Black
Product Type: Support
Product Use: Support for Arthritic Joints, Tendonitis, Tennis/Golf Elbow
Properties: Adjustable, Breathable, Reusable
Size: Adjustable
Sizes Available: One Size - Adjustable
Support Level: Moderate
Support Level Description: Provides adjustable levels of compression, support and therapeutic heat retention to help relieve symptoms associated with strains, sprains, arthritis and muscle pain.
Type: Support
Where to Measure: Measure around forearm below elbow.
eClass 14 Classification Group: 34200201

ACE™ Ankle Support 207248, Adjustable

3M ID 70006853066 UPC 00051131198067

Details

New! Larger perforations for ultimate breathability
Provides moderate support and adjustable compression
Adjustable straps for customizable compression, support, and fit
Use when support is needed for daily activities
Easy-to-use two-point adjustment

Typical properties

Body Part: Ankle
Brands: ACE™
Condition: Sprains, Strains, Tendonitis
Factory ISO Certification: No ISO Certification information available
Fit Range: Fits Womens Shoe Size (US): 6 to 12
Fits Mens Shoe Size (US):
6 to 14
Ideal For: Baseball, Basketball, Cross training, Golf, Soccer, Tennis, Volleyball
Material: Neoprene, Nylon, Polyester, Spandex
Performance Zone Category: Return to Activity
Product Color: Black
Product Type: Support
Product Use: General Soreness, Sprains & Strains, Tendonitis
Properties: Adjustable, Breathable, Non Latex Containing, Odor Control
Size: Adjustable
Sizes Available: One Size - Adjustable
Support Level: Moderate
Type: Support
Where to Measure: Measure shoe size.
eClass 14 Classification Group: 34200201

ACE™ Brand Elastic Bandage with Hook Closure

3M ID COBBLW014200 UPC 00051131203655

Details

Convenient hook-and-loop closure enables bandage to be wrapped easily and secured without clips
Provides moderate support to weak, sore muscles and joints
Comfortable design is intended for prolonged wear
Easy-to-use design
Fits discreetly under cloth

Typical properties

Application: Securing Hot/Cold, Support/Compression
Body Part: Multi-Purpose
Brands: ACE™
Closure Method: Hook & Loop
Factory ISO Certification: No ISO Certification information available
Latex-free: Yes
Performance Zone Category: Injury Care
Product Color: Beige
Product Type: Bandage
Properties: Breathable, Non Latex Containing, Reusable
Sizes Available: 2" width,3" width,4" width
Support Level: Moderate
Type: Bandage
eClass 14 Classification Group: 34200190

Dimensions and Classifications

Overall Width (Imperial): 2 in, 3 in, 4 in

ACE™ Brand Deluxe Back Stabilizer, Adjustable

3M ID CBGBLRUS1493 UPC 00051131205017

Details

Stabilizing design offers a customizable level of support
Dual compression straps for back and abdominal support
Breathable materials enhance airflow to help keep skin dry
Rigid stays and lumber pad for added stability
Fits comfortably under clothing

Typical properties

Body Part: Back
Brands: ACE™
Condition: Back Pain
Factory ISO Certification: No ISO Certification information available
Fit Range: Up to 48" waist
Latex-free: No
Package Contents: 1/pack
Product Color: Gray
Product Type: Support
Product Use: Back Pain, General Soreness, Support for a saggy abdomen
Size: Adjustable
Sizes Available: One Size - Adjustable
Support Level: Firm-Stabilizing, Moderate
Type: Support
Where to Measure: Measure around waist.
eClass 14 Classification Group: 34200201

Nexcare™ Athletic Wrap

3M ID CBGBLRUS1507 UPC 00051131666863

Details

Breathable design creates a comfortable barrier between your skin and first aid or sports tape
Provides customizable support and compression to elbows, wrists, ankles and knees
Easy to use for hassle-free application and removal
Helps secure hot and co

Typical properties

Body Part: Multi-Purpose
Brands: Nexcare™
Closure Method: Self-adhering
Factory ISO Certification: No ISO Certification information available
Latex-free: No
Package Contents: 1 Pack
Product Color: Black, Red, Tan
Product Type: Athletic Wrap, Bandage, Wraps
eClass 14 Classification Group: 34200190

Dimensions and Classifications

Overall Length (Imperial): 180 in
Overall Width (Imperial): 3 in

FUTURO™ Night Plantar Fasciitis Sleep Support

3M ID CBGBLW011002 UPC 00051131201613

Details

Helps relieve plantar fasciitis symptoms
Foot strap for custom secure fit around your foot
Strong hook tab fasteners to hold securely while wearing
Breathable, moisture-releasing straps are adjustable, durable and soft
Soft edges feel smooth against you

Typical properties

Body Part: Foot/Heel
Brands: FUTURO™
Condition: Arthritis, Pinched Nerve, Plantar Fasciitis, Sprains, Strains, Tendonitis
Factory ISO Certification: No ISO Certification information available
Fit Range: 8" to 15"
Product Color: Blue
Product Type: Support, Wrap around
Product Use: Arch/Heel Pain, Foot, Arch & Heel Pain, Foot/Heel Pain, General Support for Athletic Activity, Moderate/Occasional Pain, Recovery, Tendonitis
Size: Adjustable
Sizes Available: One Size - Adjustable
Support Level: Firm, Firm-Stabilizing
Support Level Description: Provides a higher level of support using a combination of power stretch and non-stretch materials and may include shock absorbing materials to help relieve symptoms associated with strains, sprains, arthritis, repetitive stress injuries and to help prevent re-injury.
Support and Compression Level: Firm, Firm-Stabilizing
Type: Support
Where to Measure: Measure around ankle 2" above ankle bone.
eClass 14 Classification Group: 34200201

FUTURO™ For Her Knee Support

3M ID CBGBLW011051 UPC 00051131190030

Details

Delivers moderate- compression and stability
Helps provide support to knees affected by symptoms associated with strains, sprains and other knee injuries
Spiral stabilizers increase comfort and stability
Plush gel cushioning enhances comfort around you

Typical properties

Body Part: Knee
Brands: FUTURO™
Condition: Arthritis, Jumper's Knee, Patella Tracking, Pinched Nerve, Repetitive Stress Injury, Runner's Knee, Sprains, Strains, Swelling, Tendonitis
Factory ISO Certification: No ISO Certification information available
Fit Range: 12" to 18"
Material: Nylon, Polyester, Polyurethane, Silicone, Spandex, Steel
Product Color: Gray
Product Type: Support
Product Use: During Strong Activity, General Support, General Support for Athletic Activity, Medial/Lateral Support, Moderate/Occasional Pain, Prevention, Recovery, Sprains, Strains, Weak, Sore Muscles & Injured Knees
Size: Adjustable
Sizes Available: One Size - Adjustable
Support Level: Moderate
Support and Compression Level: Moderate
Type: Support
Where to Measure: Measure around kneecap while standing.
eClass 14 Classification Group: 34200201

FUTURO™ Therapeutic Arch Support, 48510EN, Adjustable

3M ID 70007017687 UPC 00051131211407

Details

Helps relieve heel, foot and arch pain with moderate support and customizable inserts, cushioning and compression
Low-profile design is compatible with footwear
Soft, stretchy fabric offers a custom fit
Breathable materials help keep your skin dry
Int

Typical properties

Body Part: Foot
Brands: FUTURO™
Condition: Arthritis, Carpal Tunnel Syndrome, Pinched Nerve, Plantar Fasciitis, Sprains, Strains
Factory ISO Certification: No ISO Certification information available
Fit Range: 8.5" to 12"
Material: Nylon, Polyester, Polypropylene, Polyurethane, Spandex, Thermoplastic Elastomer (TPE)
Product Color: Black
Product Type: Support
Product Use: Arch/Heel Pain, Foot, Arch & Heel Pain, General Support for Athletic Activity, Moderate/Occasional Pain, Recovery
Size: Adjustable
Sizes Available: One Size - Adjustable
Support Level: Moderate
Support and Compression Level: Moderate
Type: Support
Where to Measure: Measure instep circumference.
eClass 14 Classification Group: 34200201

Nexcare™ No Hurt Wrap

3M ID COBBLW014027 UPC 00051131668751

Details

Wrap adheres to itself, but not to skin or hair
Leaves no residue on skin when removed
Use as an outer wrap to fasten gauze, pads and other dressings
Breathable construction provides ventilated comfort
Tears by hand—no scissors required
Size: 1" x 80

Typical properties

Application: Caregivers, Kids, Post-Surgical / Sutures / Stitches, Securing Gauze Pads, Securing Medical Devices, Sensitive Skin
Body Part: Multi-Purpose
Brands: Nexcare™
Closure Method: Self-adhering
Condition: Aches/Sprains/Strains
Factory ISO Certification: No ISO Certification information available
Hospital Name: Coban
Latex-free: Yes
Material: Self-adhering
Package Contents: 1 Pack
Product Color: Tan
Product Type: Wrap
Properties: Breathable, Conformable, Cushioning, Latex Free, Self-adhering
Solution for: Post-Surgical / Sutures / Stitches, Secures gauze/medical device, Sensitive Skin
Wound Type: Post-Surgical Incisions
eClass 14 Classification Group: 34200190

Dimensions and Classifications

Overall Length (Imperial): 2.2 yd, 80 in
Overall Length (Metric): 2 m
Overall Width (Imperial): 1 in, 2 in, 3 in
Overall Width (Metric): 25.4 mm, 50.8 mm, 76.2 mm

ACE™ Brand Adjustable Elbow Support

3M ID COBBLW014096 UPC 00051131208971

Details

New! Larger perforations for ultimate breathability
Provides compression and support to stiff, weak, or injured elbows and sore muscles
Use when support is needed for daily activities
Soft, neoprene-blend material is breathable to help keep you cool an

Typical properties

Body Part: Elbow
Brands: ACE™
Factory ISO Certification: No ISO Certification information available
Fit Range: 7" to 13", 8" to 16"
Latex-free: Yes
Material: Neoprene, Nylon, Polyester, Spandex
Performance Zone Category: Return to Activity
Product Color: Black
Product Type: Support
Product Use: General Soreness, Support for Arthritic Joints, Swelling
Properties: Adjustable, Breathable, Non Latex Containing, Odor Control
Size: Adjustable
Sizes Available: One Size - Adjustable
Support Level: Moderate
Support Level Description: Provides adjustable levels of compression, support and therapeutic heat retention to help relieve symptoms associated with strains, sprains, arthritis and muscle pain.
Type: Support
Where to Measure: Measure around elbow.
eClass 14 Classification Group: 34200201

ACE™ Brand Ankle Brace with Side Stabilizers

3M ID COBBLW014162 UPC 00051131203914

Details

Quick lace strapping system can be positioned over front or back of ankle for increased comfort and flexibility
Strapping mechanism allows for full adjustment around ankle as well as under heel for a personalized fit
Provides customizable levels of comp

Typical properties

Body Part: Ankle
Brands: ACE™
Condition: Sprains, Strains
Factory ISO Certification: No ISO Certification information available
Fit Range: 7.5" to 11"
Latex-free: No
Material: Natural Rubber Latex, Neoprene, Nylon, Polyester, Steel
Performance Zone Category: Injury Prevention
Product Color: Black
Product Type: Brace, Support
Product Use: General Soreness, Sprains & Strains
Properties: Adjustable, Breathable, Reusable
Size: Adjustable
Sizes Available: One Size - Adjustable
Support Level: Moderate
Support Level Description: Provides moderate support and stabilization to help prevent re-injury and relieve symptoms associated with strains, sprains, arthritis and repetitive stress injuries.
Type: Brace
Where to Measure: Measure around ankle.
eClass 14 Classification Group: 34200201

ACE™ Brand Elasto-Preene™ Elbow Support

3M ID COBBLW014174 UPC 00051131203921

Details

Stretchy design conforms to your elbow for comfort and mild compression
Soft, breathable neoprene-blend panel stitched around the elbow joint allows for heat retention
Flexible design allows a full range of motion
Convenient design can be worn on either

Typical properties

Body Part: Elbow
Brands: ACE™
Factory ISO Certification: No ISO Certification information available
Fit Range: S/M fits 9" to 11"
L/XL fits 11" to 13"
Latex-free: No
Material: Neoprene, Nylon, Nylon, Polyester, Spandex, Polyester, Polyurethane, Rubber, Spandex
Performance Zone Category: Injury Care
Product Color: Black
Product Type: Support
Properties: Breathable, Reusable
Size: Large/X-Large, Small/Medium
Sizes Available: Large/X-Large, Small/Medium
Support Level: Mild
Type: Support
Where to Measure: Measure circumference around mid-section of elbow joint.
eClass 14 Classification Group: 34200201

ACE™ Brand Wrap Around Wrist Support

3M ID COBBLW014187 UPC 00051131203853

Details

Provides moderate support to sore, weak and injured wrists
Two adjustable straps for customized fit and support
Breathable, lightweight materials for all-day comfort
Limits motion to help protect tender wrists
Low profile design
One size fits most
F

Typical properties

Body Part: Wrist
Brands: ACE™
Condition: Arthritis, Swelling
Factory ISO Certification: No ISO Certification information available
Fit Range: 5.5" to 9.5"
Performance Zone Category: Return to Activity
Product Color: Black
Product Type: Support
Product Use: General Soreness, Support for Arthritic Joints, Swelling
Properties: Adjustable, Breathable, Reusable
Size: One Size Fits Most
Sizes Available: One Size - Adjustable
Support Level: Moderate
Support Level Description: Provides adjustable levels of compression, support and therapeutic heat retention to help relieve symptoms associated with strains, sprains, arthritis and muscle pain.
Type: Support
Where to Measure: Measure around wrist at smallest point.
eClass 14 Classification Group: 34200201

ACE™ Brand Elastic Bandages

3M ID COBBLW014201 UPC 00051131208148

Details

Innovative clip snaps in place, holds securely and is easily adjusted
Provides moderate support to weak, sore muscles and joints
Comfortable design is intended for prolonged wear
Easy-to-use wrap design
Fits discreetly under clothing
Wrap conforms to

Typical properties

Application: Securing Hot/Cold, Support/Compression
Body Part: Multi-Purpose
Brands: ACE™
Closure Method: Clip
Factory ISO Certification: No ISO Certification information available
Injury: General Soreness, Sprains & Strains, Swelling
Latex-free: Yes
Performance Zone Category: Injury Care
Product Color: Beige
Product Type: Bandage
Properties: Breathable, Non Latex Containing, Reusable
Size: One Size Fits Most
Sizes Available: 2" width,3" width,4" width,6" width
Support Level: Moderate
Type: Bandage
eClass 14 Classification Group: 34200190

Dimensions and Classifications

Overall Width (Imperial): 2 in, 4 in, 6 in

ACE™ Brand Compression Elbow Sleeve with Pad

3M ID CBGBLRUS1495 UPC 00051131194175

Details

Anatomical design conforms to your arm for comfort, fit and compression

Ideal for sore, weak and injured elbows

Strategically placed EVA closed cell foam pad helps protect your elbow from impact and scrapes while the flexible hex pattern promotes natura

Typical properties

Body Part: Elbow

Brands: ACE™

Factory ISO Certification: No ISO Certification information available

Fit Range: S/M fits: 9" to 10.5"
L/XL fits: 10" to 12.5"

Product Color: Black

Product Type: Support

Size: Large/X-Large, Small/Medium

Sizes Available: Large/X-Large, Small/Medium

Support Level: Mild

Type: Support

Where to Measure: Measure around elbow joint.

eClass 14 Classification Group: 34200201

ACE™ Brand Carpal Tunnel Wrist Stabilizer, One Size

3M ID CBGBLRUS1506 UPC 00051131221796

Details

Provides firm, stabilizing support to injured wrists
Helps provide relief from symptoms associated with Carpel Tunnel Syndrome and other wrist injuries (Physicians often recommend the use of a rigid wrist brace during management of carpal tunnel syndrom

Typical properties

Body Part: Wrist

Brands: ACE™

Condition: Sprains, Strains

Factory ISO Certification: No ISO Certification information available

Fit Range: 5.5" to 9"

Latex-free: Yes

Material: Aluminum, Nylon, Polyester, Polypropylene, Polyurethane, Spandex

Net Weight (Imperial): 0.251 lb, 0.275 lb

Performance Zone Category: Injury Prevention

Product Color: Gray

Product Type: Brace

Product Use: Sprains & Strains

Properties: Adjustable, Gel Cushion, Non Latex Containing, Odor Control

Size: Adjustable

Sizes Available: One Size - Adjustable

Support Level: Firm

Type: Brace

Where to Measure: Measure around wrist at smallest point.

eClass 14 Classification Group: 34200201

Dimensions and Classifications

Overall Depth (Imperial): 1.5 in

Overall Height (Imperial): 9 in

Overall Width (Imperial): 3.75 in

Nexcare™ Strong Hold Pain-Free Removal Bandages

3M ID CBGBLRUS1510 UPC 00051131193574

Details

Hold strong for up to 24 hours
Pain-free removal
Gentle removal from hair
Ideal for wounds requiring frequent bandages changes
Hypoallergenic adhesive
Repositionable for optimal placement
Great for use on kids, the elderly and folks with hairy skin

Typical properties

Brands: Nexcare™
Factory ISO Certification: No ISO Certification information available
Material: Fabric
Package Contents: 20 pack,6 Pack
Product Color: Blue
Product Type: Bandage
Properties: Repositionable
Size: Assorted
Sizes Available: 20 ct. Asst: 5 at 1.15" x 3" (29mm x 76mm), 10 at .9" x 2.25" (22mm x 57mm) 5 at .96" x 1.15" (24mm x 29mm); Knee & Elbow: 2" x 4" (50mm x 101mm)
Solution for: Caregivers, Kids, Knees/Elbows, Pain-Free Removal, Sensitive Skin
eClass 14 Classification Group: 34400201

Dimensions and Classifications

Overall Length (Imperial): 4 in
Overall Width (Imperial): 2 in

FUTURO™ Posture Corrector, One Size - Adjustable

3M ID CBGBLRUS1520 UPC 00051131221871

Details

Stretches chest and shoulder muscles to promote better posture
Fully adjustable shoulder straps provide personalized comfort
Hook-and-loop straps offer a secure fit
Stretchy neoprene materials contour to the body for a streamlined look
Repositionable

Typical properties

Body Part: Back
Brands: FUTURO™
Condition: Back Pain
Factory ISO Certification: No ISO Certification information available
Material: Neoprene, Nylon, Polyester, Spandex
Product Color: Black
Product Type: Postural Support Device, Support
Product Use: During Strong Activity, Moderate/Occasional Pain, Post Surgery, Prevention, Recovery, Severe/Chronic back pain, Support for a saggy abdomen
Size: Adjustable
eClass 14 Classification Group: 34200201

Nexcare™ Duo Adhesive Gauze Pads DSA34-4, 3 in x 4 in (76 mm x 101 mm), 4/pk

3M ID 70007071122 UPC 00051131225404

Details

Proprietary silicone advanced technology
Provides all-day protection plus pain-free removal in one dressing
Water resistant adhesive, stays on when wet
Holds up to 72 hours
360-degree protection around a non-stick pad
Leaves minimal adhesive residue

Typical properties

Brands: Nexcare™
Factory ISO Certification: No ISO Certification information available
Material: Plastic
Package Contents: 4 Pack
Product Color: Tan
Product Type: Adhesive Pad
Sizes Available: 3 in x 4 in
eClass 14 Classification Group: 34400201

Dimensions and Classifications

Overall Length (Imperial): 3 in
Overall Width (Imperial): 4 in

ACE™ Open Knee Support

3M ID CBGBLRUS1540 UPC 00051131199910

Details

Compression and support for painful knee joints
Neoprene blend material provides compression and heat retention
Open patella design for comfort
Available in size: M, L, XL
#1 Pharmacist Recommended Brand of Braces & Supports (Based on Pharmacy Times a

Typical properties

Body Part: Knee
Brands: ACE™
Condition: Sprains, Strains
Factory ISO Certification: No ISO Certification information available
Fit Range: 15.75-16", 17.75" & over, 11" to 22"
Latex-free: Yes
Material: Neoprene, Nylon
Product Color: Black
Product Type: Support
Size: Large, Medium, X-Large
Where to Measure: Measure circumference around mid-section of knee joint
eClass 14 Classification Group: 34200201

FUTURO™ Comfort Fit Knee Stabilizer, Adjustable

3M ID 70007070447 UPC 00051131224599

Details

Firm support, stabilization, and adjustable compression for weak, sore or injured knees

Designed for all-day and everyday comfort and support

Dual side stabilizers and patella ring provide support while allowing range of motion

Ultra breathable and moi

Typical properties

Body Part: Knee

Brands: FUTURO™

Condition: Arthritis, Jumper's Knee, Patella Tracking, Pinched Nerve, Runner's Knee, Sprains, Strains, Swelling, Tendonitis

Factory ISO Certification: No ISO Certification information available

Material: Neoprene, Nylon, Polyester, Spandex, Steel

Product Color: Gray

Product Type: Stabilizer

Size: Adjustable

Support and Compression Level: Firm

eClass 14 Classification Group: 34200201

FUTURO™ Comfort Fit Compression Knee Support, Adjustable

3M ID 70007070454 UPC 00051131224605

Details

Moderate support and adjustable compression for weak, sore or injured knees
Designed for all-day and everyday comfort and support
Patella ring provides support while allowing range of motion
Ultra breathable and moisture wicking, neoprene blend materia

Typical properties

Body Part: Knee
Brands: FUTURO™
Factory ISO Certification: No ISO Certification information available
Material: Neoprene, Nylon, Polyester, Spandex
Product Color: Gray
Product Type: Support
Size: Adjustable
Support and Compression Level: Moderate
eClass 14 Classification Group: 34200201

Vetbond Tissue Adhesives

3M ID B00016067 UPC 00051115053603

Details

Strong bond polymerizes in seconds

Economical 3mL bottle with four "reusable" applicator tips

Blue dye for easy-to-see drop application

Ideal for a variety of procedures, including cat declaws, dew claw removal, closing minor lacerations, tooth extracti

Typical properties

Brands: Vetbond™

Factory ISO Certification: No ISO Certification information available

Package Contents: 1 Bottle

Product Type: Tissue Adhesive

eClass 14 Classification Group: 34180307

3M™ Attest™ Auto-reader 490, plug B (NA)

3M ID 7100214863 UPC 00707387785642

Details

10-well dual auto-reader designed for use with 3M™ Attest™ Super Rapid Readout Biological Indicator 1491 for Steam Sterilization*, 3M™ Attest™ Super Rapid Readout Biological Indicator 1492V for Steam Sterilization* and 3M™ Attest™ Rapid Readout Biological

Typical properties

Biological Indicator System: Super Rapid
Brands: Attest™
Catalog Number: 490
Cladimed Code: Non applicable
Compatible Indicator: 1295, 1491, 1492V
Factory ISO Certification: No ISO Certification information available
Incubation Period: 24 Minute
Maximum Temperature (Celsius): 40 °C, 60 °C
Maximum Temperature (Fahrenheit): 104 °F, 140 °F
Number of Wells: 10
Plug Type: B, EF, G, H, I, J, K, L, M, O
Product Type: Incubator
Sterilization Method: Hydrogen Peroxide, Steam
Total Units per Case: 1 per Case

Dimensions and Classifications

Overall Height (Imperial): 3.25 in
Overall Height (Metric): 82.55 mm
Overall Length (Imperial): 8.75 in
Overall Length (Metric): 222.25 mm

3M™ Coban™ Self-Adherent Wrap with Latex

Details

Self-adherent elastic wrap provides a reliable hold, maintains mild compression* and can be used for strain and sprain support and secure dressing or devices without the need to for adhesives, pins, clips, or tape *May use as a component in a compression

Typical properties

Brands: Coban™

Catalog Number:

1583W,1586,1584,1583B,1583R,1583,1584B,1582,1581,1581B,1582B

Cladimed Code: M50AB03

Closure Method: Self-adhering

Condition: Dressing & Device Securement, I.V. Related, Skin Care, Wound Care

Department: Cardiovascular, Critical Care, Dialysis Center, EMERGENCY, I.V.

Therapy, Intensive Care Unit, Medical-Surgical, Operating Room-Surgery,

Pediatrics, Urgent Care, Wound Care

Dressing and Device Securement Condition Type: Adhesive Trauma, Skin

Injuries-Maceration, Surgical Wound, Tube & Device Securement-Lightweight

Tubes & Devices

Factory ISO Certification: No ISO Certification information available

Hypoallergenic: No

IV Related Condition Type: CVC PICC, PIV

Latex: Yes

Latex-free: No

Material: Elastic

Product Color: Blue, Light Brown, Red, Tan, White

Product Type: Self-Adherent Wraps

Sterile: No

Therapeutic Area and Conditions: Compression Therapy and Dressing Retention,

Physiotherapy

Total Units per Case: 12 per Case, 18 per Case, 24 per Case, 30 per Case, 36 per Case

Units per Pack: 12 , 30

eClass 14 Classification Group: 34200190

Dimensions and Classifications

Overall Length (Imperial): 5 yd

Overall Length (Metric): 4.5 m

Overall Width (Imperial): 1 in, 2 in, 3 in, 4 in, 6 in

Overall Width (Metric): 2.5 cm, 5 cm, 7.5 cm, 10 cm, 15 cm, 75 mm

Nexcare™ Thin and Transparent Acne Patch BA-117, 3x15x12mm+3x24x10mm, 30 Pack/Case

3M ID UU012177869 UPC 04710367732648

Details

Patch is discreetly thin and clear, so you barely know it's there
Visibly indicates it's working by changing color
Hydrocolloid material helps by absorbing acne discharge
Patch is breathable and comfortable to wear day and night
Tab makes it easy to l

Typical properties

Brands: Nexcare™
Factory ISO Certification: No ISO Certification information available
eClass 14 Classification Group: 45090990

Nexcare™ Thin and Transparent Acne Patch BA-039, 1x15x12mm+1x24x10mm, 30 Pack/Case

3M ID UU012177844 UPC 04710367732624

Details

Patch is discreetly thin and clear, so you barely know it's there
Visibly indicates it's working by changing color
Hydrocolloid material helps by absorbing acne discharge
Patch is breathable and comfortable to wear day and night
Tab makes it easy to l

Typical properties

Brands: Nexcare™
Factory ISO Certification: No ISO Certification information available
eClass 14 Classification Group: 45090990

Nexcare™ Acne Cover AC-108

3M ID 70007026951 UPC 00051131216709

Details

Works like a sponge to remove pus and oil

Gentle yet effective

Acts as a protective cover, helping reduce the urge to touch and pick at the blemishes

Visibly indicates that it is working. Once color changes to white, oily secretion has been absorbed

W

Typical properties

Brands: Nexcare™

Factory ISO Certification: No ISO Certification information available

Package Contents: 108 Pack

Solution for: Acne

eClass 14 Classification Group: 45090990

Nexcare™ Acne Cover AC-036

3M ID 70005149250 UPC 00051131208995

Details

GENTLE YET EFFECTIVE: One 36-count assorted pack of 24 small and 12 medium Nexcare Absorbing Acne Covers, a gentle yet effective acne skin patch to help get you back to looking your best

ABSORBENT: These acne patches are breathable, comfortable and work

Typical properties

Application: Skin Care

Brands: Nexcare™

Condition: Acne

Factory ISO Certification: No ISO Certification information available

Material: Clear Film

Package Contents: 36 Pack

Product Type: Skin Products

Properties: Absorbent, Breathable

Sizes Available: 36-ct Asst (Cat #AC-036): 24 - 5/16" dia.; 12 - 15/32" dia.

Solution for: Skin Care

Wound Type: Other

eClass 14 Classification Group: 45090990

3M™ Ranger™ Blood/Fluid Warming Standard Flow Set, 24240, 10/Case

3M ID 7100239281 UPC 50707387805000

Details

Not made with natural rubber latex; Not made with DEHP
Flow rates from KVO - 150 mL/min or 9 L/hr
Disposable set slides easily into the warming unit and only fits in one direction, making set up hassle-free
Cost effective
Latex-free

Typical properties

Approved Environmental Marketing Claim (EMC): Not made with DEHP
Brands: Ranger™
Clinical Area: OR
Contents: Heat exchanger, bubble trap, needleless air aspiration port, 60 inch patient line
Environmental claim being made: Yes
Environmental claim relates to: Product
Factory ISO Certification: No ISO Certification information available
Flow Rate (Imperial): 0.04 GPM
Fluid Type: Blood/Fluid
Model: 24240
Pressure Infusion: Up to 300 mmHg maximum dynamic operating pressure
Priming Volume: 44 mL
Product Type: Disposable Set
Quantity: 10 Case
Set Type: Standard Flow/Routine
Sterile: Ethylene Oxide (EO)
Units per Pack: 10
eClass 14 Classification Group: 34540392

3M™ Scotchcast™ Conformable Splint

Details

Low-profile, one-sided felt padding is less bulky so it molds more easily to the patient for a closer, more conformable fit
All-in-one splint allows for easy application and time savings. Faster application increases patient turnaround
Provides strong,

Typical properties

Brands: Scotchcast™
Factory ISO Certification: No ISO Certification information available
Form: Pre-cut
Model: 72312, 72530
Padding: Padded
Product Type: Conformable Splint
Product Use: Splinting
Units per Pack: 10
eClass 14 Classification Group: 34200204

Dimensions and Classifications

Overall Length (Imperial): 12 in, 30 in
Overall Length (Metric): 30.5 cm, 76.2 cm
Overall Width (Imperial): 3 in, 5 in
Overall Width (Metric): 7.6 cm, 12.7 cm

3M™ Tegaderm™ Transparent Film Roll

Details

Provides a waterproof, sterile barrier to external contaminants including liquids, bacteria and viruses. In vitro testing shows that the transparent film provides a viral barrier from viruses 27 nm in diameter or larger while the dressing remains intact w

Typical properties

Border: No

Brands: Tegaderm™

Cladimed Code: F51CA07

Condition: Dressing & Device Securement, I.V. Related, Pressure Ulcer, Skin Care, Wound Care

Department: Cardiovascular, Dialysis Center, EMERGENCY, I.V. Therapy, Intensive Care Unit, Medical-Surgical, Oncology, Operating Room-Surgery, Pediatrics, Radiology, Urgent Care, Wound Care

Dressing Type: Film

Dressing and Device Securement Condition Type: Adhesive Trauma, Skin Injuries-Mechanical, Tube & Device Securement-Lightweight Tubes & Devices

Factory ISO Certification: No ISO Certification information available

IV Related Condition Type: Arterial Catheter, CVC Dialysis, CVC Implanted Port, CVC PICC, CVC Short-Term, CVC Tunneled, Epidural Catheter, PIV

Latex: No

Product Type: Standard Dressing

Units per Pack: 1

Waterproof: Yes

eClass 14 Classification Group: 34180304

Dimensions and Classifications

Overall Length (Imperial): 10.936 yd, 10.94 yd

Overall Length (Metric): 10 m

Overall Width (Imperial): 2 in, 3.94 in, 5.906 in

Overall Width (Metric): 5 cm, 10 cm, 15 cm

3M™ Medical Tape 9926T, Single Sided Tan Tricot Fabric, 83# Liner, Configurable

3M ID 7100127443

Details

Acrylic Adhesive
Breathable
Good Processability

Typical properties

Adhesive Material: Acrylate
Adhesive Type: Acrylic/Acrylate
Backing (Carrier) Material: Knit Polyester Tricot Fabric
Brands: 3M™
Breathable: Yes
Conformability: High
Factory ISO Certification: No ISO Certification information available
Fluid Resistance Backing/Carrier: No
Hypoallergenic: No
Latex: No
Liner Color: White
Liner Material: Paper
Liner Weight: 83.0 lb.
Material: Tricot Fabric
Maximum Length (Metric): 183 m
Maximum Width Capacity: 43 in
Maximum Width Capacity (Metric): 110 mm
Printable Backing: Yes
Product Color: Tan
Product Type: Non-woven Polyester & Polyester Blend Tape
Product Usage: Adhesion to Skin, Adhesion to Substrate
Sterilization Method: Ethylene Oxide (EO), Gamma
Tape Color: Tan
Tape Type: Single Sided Fabric Tapes
eClass 14 Classification Group: 34180201

Dimensions and Classifications

Overall Thickness (Imperial): 1 in
Overall Thickness (Metric): 0.23 mm
Overall Width (Imperial): 43 in
Overall Width (Metric): 109.22 cm

3M™ Tegaderm™ Alginate AG Silver Dressing 90305, Square, 6 IN X 6 IN
5/Carton 4 Cartons/Case

3M ID 7100074337 UPC 50707387583618

Details

Antimicrobial Barrier- Ionic silver complex is released, protecting the wound from a broad spectrum of microorganisms, including antibiotic-resistant bacterias like MRSA and VRE

Comformable - Soft-gelling absorbency allows for conformity to wounds, provi

Typical properties

Brands: Tegaderm™

Condition: Pressure Ulcer, Wound Care

Department: EMERGENCY, Intensive Care Unit, Medical-Surgical, Operating Room-Surgery, Urgent Care, Wound Care

Dressing Type: Alginate Silver

Factory ISO Certification: No ISO Certification information available

Hypoallergenic: No

Latex: No

Product Type: Silver Dressing

eClass 14 Classification Group: 34210402

Dimensions and Classifications

Overall Length (Imperial): 6 in

Overall Length (Metric): 15.24 cm

Overall Width (Imperial): 6 in

Overall Width (Metric): 15.24 cm

3M™ Tegaderm™ Alginate Ag Silver Dressing 90307, 1 IN x 2 IN, 5 dressings/CT 4 CT/CS

3M ID 7000128710 UPC 50707387583625

Details

Antimicrobial Barrier- Ionic silver complex is released, protecting the wound from a broad spectrum of microorganisms, including antibiotic-resistant bacterias like MRSA and VRE

Comfortable - Soft-gelling absorbency allows for conformity to wounds, provi

Typical properties

Brands: Tegaderm™

Clinical Area: Dialysis Centre

Condition: Pressure Ulcer, Wound Care

Department: EMERGENCY, Intensive Care Unit, Medical-Surgical, Operating Room-Surgery, Urgent Care, Wound Care

Dressing Type: Alginate Silver

Factory ISO Certification: No ISO Certification information available

Hypoallergenic: No

Latex: No

Product Type: Silver Dressing

Wound Care Condition Type: Venous Leg Ulcer

eClass 14 Classification Group: 34210402

Dimensions and Classifications

Overall Length (Imperial): 12 in

Overall Length (Metric): 30.48 cm

Overall Width (Imperial): 1 in

Overall Width (Metric): 2.54 cm

3M™ Red Dot™ Soft Cloth Monitoring Electrode

Details

Soft cloth backing is conformable for increased patient comfort
Provide good performance for up to 30 days after pouch is opened
Can be used on adults with fragile skin
Provide good performance for up to 30 days after pouch is opened
Can be used on ad

Typical properties

Age Group: Adult
Backing Material: Sontara
Brands: Red Dot™
Case Packaging: 3 Electrodes/Package; 200 Packages or 600 Electrodes/Case,
5 Electrodes/Package; 200 Packages or 1000 Electrodes/Case, 50
Electrodes/Bag; 20 Bags or 1000 Electrodes/Case
Cladimed Code: K51FG01
Department: Cath Lab, EMS/ER, Echo-Cardio, ICU/CCU, OR, Pediatric ICU
Electrode Size: 1.25", 2.4" Diameter
Electrode Type: Diaphoretic, Monitoring
Factory ISO Certification: No ISO Certification information available
Gel Type: Solid
Material: Soft Cloth
Model: 2238, 2255-50, 2268-3, 2268-5
Monitoring Event: Echo-Cardio, Pediatric Monitoring, Telemetry/Holter/Event
Package Contents: 3 Electrodes/Package, 5 Electrodes/Package, 50
Electrodes/Bulk Bag
Patient: Adult, Pediatric
Pre-wired: No
Product Type: Electrode
Product Type Free Format: Electrode
Product Use: Diaphoretic, Monitoring
Radiolucency: Radiolucent, Radiopaque
Skin Prep Included: No
Skin Type: Fragile, Normal
Solution: Fragile Skin, Monitoring, Pediatrics
Sterile: No
Units per Pack: 3 , 5 , 50
Wear Time: Up to Three Days
eClass 14 Classification Group: 34580108

Dimensions and Classifications

Overall Diameter (Imperial): 1.25 in, 2.4 in
Overall Diameter (Metric): 3.2 cm, 6 cm, 6.1 cm

3M™ Electrosurgical Reusable Cable 21172

3M ID 7000053620 UPC 00707387468057

Details

21172 Electrosurgical Patient Plate Clamp

Pre-attached clamp

Provides a safe pathway for the return of electrosurgical radio frequency (RF) current

Typical properties

Brands: 3M™

Clinical Area: Critical Care, Emergency Medical Services (EMS), Emergency Room, Intensive Care, Pediatric, Physician Office, Surgery

Disposable: No

Factory ISO Certification: No ISO Certification information available

Product Type: Cable

Product Use: Accessory

eClass 14 Classification Group: 34580113

3M™ Steri-Drape™ Aperture Drape 9027, Adjustable, 40 per Carton / 4 Cartons per Case

3M ID 7000002893 UPC 00707387577438

Details

Two piece Adjustable Aperture Drape

Resistant to Strikethrough

Fluid Control Features

Reliable, dependable adhesive (around aperture, etc.) stays secure throughout the procedure

Reliable, dependable adhesive (around aperture, etc.) stays secure thro

Typical properties

Brands: Steri-Drape™

Cladimed Code: E51BA99

Factory ISO Certification: No ISO Certification information available

Loophole Length (Metric): 9 cm

Loophole Width (Metric): 25 cm

Product Color: Blue

Product Type: Aperture Drape

Product Use: Procedure Specific

Units per Pack: 40

Dimensions and Classifications

Overall Length (Metric): 75 cm

Overall Width (Metric): 50 cm

**3M™ Steri-Drape™ Aperture Drape, 25 per Carton / 4 Cartons per Case,
9023**

3M ID 7000053566 UPC 00707387456023

Details

Superior Strength and Comfort
Impervious to Strikethrough
Fluid Control Features

Typical properties

Brands: Steri-Drape™
Factory ISO Certification: No ISO Certification information available
Product Type: Aperture Drape
Product Use: Procedure Specific
Units per Pack: 25

Dimensions and Classifications

Overall Length (Metric): 76 cm
Overall Width (Metric): 170 cm

3M™ Steri-Drape™ Aperture Drape, Adjustable, 25 per Carton / 4 Cartons per Case, 9027L

3M ID 7000053869 UPC 00707387581596

Details

Two piece Adjustable Aperture Drape
Resistant to Strikethrough
Fluid Control Features
Reliable, dependable adhesive (around aperture, etc.) stays secure throughout
the procedure
Reliable, dependable adhesive (around aperture, etc.) stays secure thro

Typical properties

Brands: Steri-Drape™
Cladimed Code: E51BA99
Factory ISO Certification: No ISO Certification information available
Loophole Length (Metric): 9 cm
Loophole Width (Metric): 25 cm
Product Color: Blue
Product Type: Aperture Drape
Product Use: Procedure Specific
Units per Pack: 25

Dimensions and Classifications

Overall Length (Metric): 150 cm
Overall Width (Metric): 100 cm

3M™ Steri-Drape™ Under Buttocks Drape with Cuff, 30 per Carton / 4 Cartons per Case, 9066

3M ID 7000053860 UPC 00707387581503

Details

Superior Strength and Comfort
Fluid Control Features
Fluid Control Features

Typical properties

Brands: Steri-Drape™
Cladimed Code: E51DA01
Factory ISO Certification: No ISO Certification information available
Product Type: Under Buttocks Drape
Product Use: Procedure Specific
Units per Pack: 30

Dimensions and Classifications

Overall Length (Metric): 85 cm
Overall Width (Metric): 85 cm

3M™ Steri-Drape™ Mayo Stand Cover, 9036, 60 Each/CAR, 4 Carton/Case

3M ID 7000128615 UPC 30707387560462

Details

Non-sterile
Remove - included in MPFN

Typical properties

Accessories: Miscellaneous
Brands: Steri-Drape™
Clinical Area: Surgery
Clinical Sub-Area: Obstetrics and Gynaecology, Orthopedics
Factory ISO Certification: No ISO Certification information available
Incise Area Width (Metric): 45 cm
Material: Fabric
Model: 9036
Procedure: General Surgery
Product Color: Blue
Product Type: Stand Cover
Product Type Free Format: Drape
Product Use: Equipment Drape
Sterile: Yes
Units per Pack: 60

Dimensions and Classifications

Overall Length (Imperial): 23.88 in
Overall Length (Metric): 58 cm
Overall Width (Imperial): 54 in
Overall Width (Metric): 137 cm

3M™ Bair Hugger™ Warming Gown Kit

Details

Provides comfort and clinical warming throughout perioperative process
Patient-adjustable warming
Prewarming capabilities
Full coverage, wrap-around design
Clinically flexible
Eliminates the need to locate patient gowning accessories

Typical properties

Brands: Bair Hugger™
Clinical Area: OR, PACU, Pre-op
Factory ISO Certification: No ISO Certification information available
Gown Size: Extra Large
Model: 84001, 84201
Product Type: Gown Kit
Quantity: 20 Case, 30 Case
Size: Standard
Style: OR Gown
Sweep: 122 in +/- 1, 64 in +/- 1
Sweep (Metric): 163 , 310
eClass 14 Classification Group: 34540392

Dimensions and Classifications

Overall Length (Imperial): 51 in
Overall Length (Metric): 130 cm

3M™ Bair Hugger™ Warming Blanket 57501, Spinal Underbody, 5/Case

3M ID 7100212590 UPC 50707387790191

Details

Single-use underbody forced-air warming blanket warms the patient while providing full, unrestricted patient access
One clear plastic drape (included) helps retain warm air around the head of the patient
Constructed of soft, radiolucent materials
Two r

Typical properties

Application: Medical
Blanket Type: Underbody
Brands: Bair Hugger™
Cladimed Code: Non applicable
Clinical Area: Cardiac & Specialty, OR, Underbody
Drape Length: 24 in
Drape Length (Metric): 61 cm
Drape Width: 48 in
Drape Width (Metric): 122 cm
Factory ISO Certification: No ISO Certification information available
Product Type: Blanket
Quantity: 5 Case
Total Units per Case: 5 per Case
Units per Pack: 5
eClass 14 Classification Group: 34540392

Dimensions and Classifications

Overall Length (Imperial): 74 in
Overall Length (Metric): 91 cm
Overall Width (Imperial): 36 in
Overall Width (Metric): 188 cm

3M™ Bair Hugger™ Warming Unit, Model 77500

Details

3M™ Bair Hugger™ warming units provide safe, quiet and effective warming to patients around the world

Typical properties

Brands: Bair Hugger™

Cladimed Code: Non applicable

Clinical Area: OR, PACU, Pre-op

Device Rating: 110-120 VAC, 50/60 Hz, 11.7 Amperes | 220-240 VAC, 50/60 Hz, 7.2 Amperes | 100 VAC, 50/60 Hz, 15 Amperes

Factory ISO Certification: No ISO Certification information available

Leakage Current: Meets UL 60601-1 and IEC 60601-1 requirements

Model Number: 775,77505

Operating Temperature: High: 43° +/- 1.5°C (109.4° +/- 2.7°F), Med: 38° +/- 1.5°C (100.4° +/- 2.7°F), Low: 32° +/- 1.5°C (89.6° +/- 2.7°F)

Product Type: Warming Unit

Quantity: 1 each

eClass 14 Classification Group: 34540301

Dimensions and Classifications

Overall Diameter (Imperial): 13 in

Overall Diameter (Metric): 33 cm

Overall Height (Imperial): 13 in

Overall Height (Metric): 33 cm

Overall Length (Imperial): 13 in

Overall Length (Metric): 33 cm

Overall Width (Imperial): 14 in

Overall Width (Metri

3M™ Reston™ Self-Adhering Foam Pads/Rolls, 1560 Series

Details

Versatile padding adheres well to a variety of surfaces
Lightweight and conformable padding can be cut, layered and shaped, allowing it to be adapted for many applications
Available in medium- and high-support pads or light support foam roll to meet you

Typical properties

Brands: Reston™
Factory ISO Certification: No ISO Certification information available
Hypoallergenic: Yes
Product Type: Foam Padding
Therapeutic Area and Conditions: First & Second Degree Burns, Leg Ulcer, Low-Heavily Exuding Wounds, Pressure Ulcer
Units per Pack: 1 , 5 , 10

Dimensions and Classifications

Overall Height (Metric): 0.5 cm, 1.25 cm, 2.5 cm
Overall Length (Imperial): 11.75 in, 196 in
Overall Length (Metric): 5 m, 29.8 cm
Overall Width (Imperial): 4 in, 7.875 in
Overall Width (Metric): 10 cm, 20 cm

3M™ CoTran™ Ethylene Vinyl Acetate Membrane Film, 9712, Configurable

3M ID 7100065957

Details

18.5% Vinyl Acetate
Translucent
Non-corona treated
18.5% Vinyl Acetate

Typical properties

Backing (Carrier) Material: Ethylene Vinyl Acetate
Brands: CoTran™
Caliper: 2 mils
Caliper (Metric): 50.8 µm
Catalog Number: 9712
Elongation CD: 600%
Elongation MD: 300%
Factory ISO Certification: No ISO Certification information available
Heat Seal Layer: Ethylene Vinyl Acetate (EVA)
MVTR (g/m²/24 hr): 97.2
Oxygen Transmission (cc/m²/24hr): N/T
Product Color: Translucent
Product Type: Transdermal Membrane
Sample Roll: 6 in x 25 yds
Sample Roll (Metric): 15 cm x 23 m
Tensile CD: 2.6 lbs/in
Tensile CD (Metric): 1200 g/25 mm
Tensile MD: 4.9 lbs/in
Tensile MD (Metric): 2200 g/25 mm
eClass 14 Classification Group: 41011103

Dimensions and Classifications

Overall Length (Imperial): 1312.336 yd
Overall Length (Metric): 1200 m
Overall Width (Imperial): 48 in
Overall Width (Metric): 122 cm

3M™ Attest™ Steam Biological Indicator, 1261

Details

Accurate BI results with 24-hour visual color readout
Color-coded (blue cap) for quick reference and easy use
Monitors gravity displacement steam sterilization processes at 270°F/132°C
Compatible with 3M™ Attest™ Biological Indicator Incubator 116
Int

Typical properties

Biological Indicator System: Standard
Brands: Attest™
Cap Color: Blue
Catalog Number: 1261,1261P
Clinical Area: Medical Device Reprocessing Department
Factory ISO Certification: No ISO Certification information available
Incubation Period: 24 Hour
Inner Packs per Case: 4 Cartons per Case
Product Color: Blue
Product Type: Biological Indicator
Product Use: Load Monitoring
Sterilization Method: Steam
Total Units per Case: 100 per Case, 400 per Case
Units per Inner Pack: 25 per Carton, 100 per Carton
eClass 14 Classification Group: 34410601

3M™ Attest™ Super Rapid Steam Biological Indicator, 1491, Blue Cap, 24 min, 50/CAR, 4 CAR/CS, 200/CS

3M ID 7000128725 UPC 30707387762958

Details

Results in just 24 minutes
Color-coded (blue cap) for quick reference and ease of use
ISO 11138-1:2017 and ISO 11138-3:2017 compliant
Monitors 270°F/132°C and 275°F/135°C, 3-minute and 10-minute, gravity displacement saturated steam sterilization process

Typical properties

Biological Indicator System: Super Rapid
Brands: Attest™
Cap Color: Blue
Catalog Number: 1491
Cladimed Code: E52IC01
Factory ISO Certification: No ISO Certification information available
Incubation Period: 24 Minute
Inner Packs per Case: 4 Cartons per Case
Product Color: Blue
Product Type: Biological Indicator
Product Use: Load Monitoring
Sterilization Method: Steam
Total Units per Case: 200 per Case
Units per Inner Pack: 50 per Carton
eClass 14 Classification Group: 34410601

3M™ Attest™ Instrument Protectors

Details

Can be used for both steam and EO sterilization
Keeps the tips of instruments from penetrating the sterile pouch
Holds the instrument in an open position for proper sterilization
For use inside a single peel pouch
No expiration date

Typical properties

Brands: Attest™
Cladimed Code: Non applicable
Factory ISO Certification: No ISO Certification information available
Model: 13911, 13913, 13915
Product Type: Instrument Protector
Product Type Free Format: Instrument Protectors
Sterilization Method: Ethylene Oxide (EO), Steam
Units per Pack: 100
eClass 14 Classification Group: 34411192

Dimensions and Classifications

Overall Length (Imperial): 6.625 in, 9.5 in
Overall Length (Metric): 12.5 cm, 168.275 mm, 241.3 mm
Overall Width (Imperial): 3.5 in, 5.5 in
Overall Width (Metric): 5 cm, 88.9 mm, 139.7 mm

3M™ Comply™ Indicator Tape Dispenser, M52, 1 Each/Case

3M ID 7000002813 UPC 00707387563516

Details

A Tabber can be attached to the tape dispenser, which automatically folds a 1/4" length of tape. Can be used for rolls up to 1" wide
Weighted base prevents the dispenser from lifting from surface when tape is being pulled
Weighted, non-slip base remains

Typical properties

Brands: Comply™
Cladimed Code: Non applicable
Clinical Area: Medical Device Reprocessing Department
Factory ISO Certification: No ISO Certification information available
Model: M52
Product Type: Indicator Tape
Product Use: Exposure Monitoring
eClass 14 Classification Group: 34410301

Dimensions and Classifications

Overall Width (Imperial): 2 in
Overall Width (Metric): 50 mm

3M™ Steri-Drape™ Cesarean-Section Drape with Ioban™ 2 Incise Film and Clear Screen, 5 per Case, 6697CA

3M ID 7100077378 UPC 50707387773965

Details

Quick application and easier fluid control with a one piece drape design
Continuous broad-spectrum antimicrobial activity with 3M Ioban 2 Incise Film
3M fabric absorbs spills and splatters, making multiple layering unnecessary and preventing strike-thru

Typical properties

Brands: Steri-Drape™
Factory ISO Certification: No ISO Certification information available
Features: Antimicrobial
Incise Area Width (Metric): 35 cm
Material: Fabric
Procedure: Obstetrics and Gynaecology
Product Color: Blue
Product Type: C-section Drape
Product Use: Specialty Sheet
Sterile: Yes
Units per Pack: 5

Dimensions and Classifications

Overall Length (Imperial): 77 in
Overall Length (Metric): 196 cm
Overall Width (Imperial): 115 in
Overall Width (Metric): 292 cm

3M™ Avagard™ Wall Bracket 9246, Molded, White, 16/CS

3M ID 7100100286 UPC 50707387770346

Details

Provides easy access
Product is not included

Typical properties

Accessory Type: Bracket
Brands: Avagard™
Dispensing System: Hand Pump
Factory ISO Certification: No ISO Certification information available
Model: 9246
Product Type: Dispenser, Bracket & Accessory
Product Use: Accessory
eClass 14 Classification Group: 20420207

ACE™ Sport Deluxe Ankle Stabilizer, Adjustable

3M ID 70007009528 UPC 00051131208834

Details

Reinforced side stabilizers help limit lateral motion
Design offers customizable levels of compression and support
Adjustable features for custom comfort
Easy-to-use design for hassle-free wear
Breathable materials allow air to circulate and helps keep

Typical properties

Body Part: Ankle
Brands: ACE™
Factory ISO Certification: No ISO Certification information available
Fit Range: 8" to 10"
Material: Elastane, Nylon, Polyester, Polyethylene, Polyurethane
Product Color: Black
Product Type: Support
Properties: Adjustable
Size: Adjustable
Sizes Available: One Size - Adjustable
Support Level: Firm
Support Level Description: Provides adjustable levels of compression, support and therapeutic heat retention to help relieve symptoms associated with strains, sprains, arthritis and muscle pain.
Type: Support
Where to Measure: Measure around ankle.
eClass 14 Classification Group: 34200201

3M™ Medical Release Liner 9955, Polypropylene, Fluoropolymer, Configurable

3M ID 7100127453

Details

Premium low release with silicone adhesives
Printable
Good Processability

Typical properties

Backing Caliper: 3.5 mil
Backing Caliper (Metric): 90 Micron
Backing Material: Polypropylene
Backing Thickness (Imperial): 3.5 mil
Backing Thickness (Metric): 90 Micron
Brands: 3M™
Breathable: No
Conformability: Low
Factory ISO Certification: No ISO Certification information available
Fluid Resistance Backing/Carrier: Yes
Hypoallergenic: Yes
Liner Caliper (Metric): 90 Micron
Liner Caliper (mils): 3.5 mil
Liner Color: Clear
Liner Material: Polypropylene
Maximum Length (Metric): 1737 m
Maximum Width Capacity: 40 in
Maximum Width Capacity (Metric): 1020 mm
Printable Backing: No
Product Color: Transparent
Product Type: Liners
Product Usage: Liners
Sterilization Method: Ethylene Oxide (EO)
Tape Color: Transparent
Tape Total Caliper (Metric): 90.0 Micron
eClass 14 Classification Group: 15360503

Dimensions and Classifications

Overall Thickness (Imperial): 1 in
Overall Thickness (Metric): 0.09 mm

3M™ Tegaderm™ HP Transparent Film Dressing Frame Style

Details

High adhesion keeps dressings in place under challenging conditions with 7 day wear time

Provides a waterproof, sterile barrier to external contaminants including liquids, bacteria and viruses. In vitro testing shows that the transparent film provides a

Typical properties

Border: No, Yes

Brands: Tegaderm™

Cladimed Code: M50AF02

Clinical Area: Cardiovascular, Dialysis Centre, Intensive Care, Oncology, Palliative Care, Radiology, Wound Care

Clinical Sub-Area: Orthopedics

Condition: Dressing & Device Securement, I.V. Related, Pressure Ulcer, Skin Care, Wound Care

Department: Cardiovascular, Dialysis Center, EMERGENCY, I.V. Therapy, Intensive Care Unit, Medical-Surgical, Oncology, Operating Room-Surgery, Pediatrics, Radiology, Urgent Care, Wound Care

Dressing Type: Film

Dressing and Device Securement Condition Type: Adhesive Trauma, Skin Injuries-Mechanical, Tube & Device Securement-Lightweight Tubes & Devices

Factory ISO Certification: No ISO Certification information available

Hypoallergenic: Yes

IV Related Condition Type: Arterial Catheter, CVC Dialysis, CVC Implanted Port, CVC PICC, CVC Short-Term, CVC Tunneled, Epidural Catheter, PICC, PIV

Latex: No

Product Type: Standard Dressing

Product Use: PIV

Therapeutic Area and Conditions: Autolytic Debridement, Partial Thickness Wounds, Pressure Ulcers, Secondary Dressing, Surgical Incisions

Units per Pack: 50 , 100

Waterproof: Yes

eClass 14 Classification Group: 34180304

Dimensions and Classifications

Overall Length (Imperial): 2.375 in, 2.75 in, 4.5 in, 4.75 in

Overall Length (Metric): 6 cm, 7 cm, 11.5 cm, 12 cm

Overall Width (Imperial): 2.375 in, 3.94 in, 4 in

Overall Width (Metric): 6 cm, 6.5 cm, 10 cm

3M™ Tegaderm™ Absorbent Clear Acrylic Dressing, 90800 Series

Details

Allows wound and incision monitoring – Transparent film and absorbent pad allows wound or surgical incision to be monitored without dressing removal
Easy to apply – Clear design takes the guesswork out of application over the wound or surgical incision

Typical properties

Brands: Tegaderm™
Case Quantity: 30.0 Cartons per Case, 4.0 Cartons per Case
Catalog Number: 90800, 90802, 90801, 90815, 90803, 90817, 90805
Cladimed Code: F51BB99
Condition: Pressure Ulcer, Wound Care
Department: Home Care, Long-Term Care, Wound Care
Dressing Type: Acrylic Dressing
Factory ISO Certification: No ISO Certification information available
Hypoallergenic: Yes
Inner Packs per Case: 4 Cartons per Case, 6 Cartons per Case
Latex: No
Product Color: Transparent
Product Type: Acrylic Dressing
Shape: Oval, Rectangular, Square
Therapeutic Area and Conditions: Friction Burns, Low-Moderately Exuding Wounds, Post-Op Wounds, Pre-Tibial Lacerations, Pressure Ulcers, Skin Graft Donor Sites
Total Units per Case: 20 per Case, 30 per Case, 40 per Case, 120 per Case
Units per Inner Pack: 5 per Carton, 10 per Carton, 30 per Carton
Units per Pack: 10 , 30
Waterproof: Yes
Wound Dressing Length (Metric): 3.8 cm, 4.5 cm, 6 cm, 8.5 cm, 10.1 cm, 14.9 cm
Wound Dressing Width (Metric): 5.7 cm, 7.6 cm, 10.1 cm, 10.7 cm, 15.2 cm, 20 cm, 30 cm
eClass 14 Classification Group: 34400201

Dimensions and Classifications

Overall Length (Imperial): 3.75 in, 5 in, 6 in, 6.25 in, 8 in, 10 in, 13.75 in
Overall Length (Metric): 9.52 cm, 12.7 cm, 15.24 cm, 15.87 cm, 20.32 cm, 25 cm, 35 cm
Overall Width (Imperial): 3 in, 3.543 in, 4.375 in, 5.625 in, 5.875 in, 7.875 in
Overall

3M™ Steri-Strip™ Blend Tone Skin Closures

Details

Less noticeable – Light color blends with many skin tones, for a more cosmetically pleasing appearance
Cost savings - A low cost alternative to sutures and tissue adhesives¹
Easy on patients - Soft, nonwoven backing and breathable design

Typical properties

Brands: Steri-Strip™
Condition: Skin Closure
Department: Critical Care, EMERGENCY, Intensive Care Unit, Labor & Delivery, Medical-Surgical, Operating Room-Surgery, Orthopedics, Pediatrics, Urgent Care, Wound Care
Factory ISO Certification: No ISO Certification information available
Latex: No
Product Color: Nude
Product Type: Skin Closures
Sterile: Yes
Units per Pack: 50
eClass 14 Classification Group: 34180306

Dimensions and Classifications

Overall Length (Imperial): 3 in, 4 in
Overall Length (Metric): 75 mm, 100 mm
Overall Width (Imperial): 0.25 in, 0.5 in
Overall Width (Metric): 6 mm, 12 mm

ACE™ Sports Tape, White, Bulk Pack 909010

3M ID 70005295350 UPC 00051131209497

Details

Tough design offers firm support
Provides protection to weak and injured joints
Strong adhesive stays put
Easy-to-use tape tears easily
Tape for a secure hold
Ideal for ankles, fingers and wrists
Works great with ACE Sports Underwrap
#1 Pharmacist

Typical properties

Brands: ACE™
Factory ISO Certification: No ISO Certification information available
Product Color: White
Product Type: Tapes/Underwrap

Dimensions and Classifications

Overall Width (Imperial): 1.5 in

ACE™ Tape 207465, 1 pack, 1.5 in x 10 yds

3M ID 70005175222 UPC 00051131208162

Details

Tough design offers firm support
Provides protection to weak and injured joints
Strong adhesive stays put
Easy-to-use tape tears easily
Tape for a secure hold
Ideal for ankles, fingers and wrists
Works great with ACE Sports Underwrap
Size: 1.5" x 1

Typical properties

Brands: ACE™
Factory ISO Certification: No ISO Certification information available
Product Color: White
Product Type: Tapes/Underwrap

Dimensions and Classifications

Overall Length (Imperial): 10 yd
Overall Width (Imperial): 1.5 in

ACE™ Sports Tape 207464, 4 pack, 1.5 in x 360 in (10 yd) in (3.81 cm x 9.14 m) White Tape

3M ID 70007042248 UPC 00051131208117

Details

- Tough design offers firm support
- Provides protection to weak and injured joints
- Strong adhesive stays put
- Easy-to-use tape tears easily
- Tape for a secure hold
- Ideal for ankles, fingers and wrists
- Works great with ACE Sports Underwrap
- Size: 1.5" x 1

Typical properties

- Brands: ACE™
- Factory ISO Certification: No ISO Certification information available
- Product Color: White
- Product Type: Tapes/Underwrap

Dimensions and Classifications

- Overall Length (Imperial): 10 yd
- Overall Width (Imperial): 1.5 in

3M™ Tegaderm™ Transparent Film Dressing Frame Style

Details

Provides a waterproof, sterile barrier to external contaminants including liquids, bacteria and viruses

Transparent dressing allows for continuous visibility to the I.V. insertion site

Adhesive is gentle on skin

Dressing flexes with skin for greater pa

Typical properties

Border: No, Yes

Brands: Tegaderm™

Cladimed Code: F51CA07,F51CA01,F51BD

Clinical Sub-Area: Orthopedics

Condition: Dressing & Device Securement, I.V. Related, Pressure Ulcer, Skin Care, Wound Care

Department: Cardiovascular, Dialysis Center, EMERGENCY, I.V. Therapy, Intensive Care Unit, Medical-Surgical, Oncology, Operating Room-Surgery, Pediatrics, Radiology, Urgent Care, Wound Care

Dressing Type: Film

Dressing and Device Securement Condition Type: Adhesive Trauma, Skin Injuries-Mechanical, Tube & Device Securement-Lightweight Tubes & Devices

Factory ISO Certification: No ISO Certification information available

Hypoallergenic: Yes

IV Related Condition Type: Arterial Catheter, CVC Dialysis, CVC Implanted Port, CVC PICC, CVC Short-Term, CVC Tunneled, Epidural Catheter, PICC, PIV

Latex: No

Pressure Ulcer Condition Type: Prevention, Stage 2, Suspected Deep Tissue Injury

Product Type: Standard Dressing

Product Use: PIV

Sterile: Yes

Therapeutic Area and Conditions: Autolytic Debridement, I.V. Therapy, Partial Thickness Wounds, Pressure Ulcers, Secondary Dressing, Surgical Incisions

Units per Pack: 10 , 20 , 50 , 100

Waterproof: Yes

Wound Care Condition Type: Abrasions, Closed Intact Surgical Wound, Donor Sites, Friction, Laceration, Superficial Partial Thickness Burns

eClass 14 Classification Group: 34180304

Dimensions and Classifications

Overall Length (Imperial): 1.75 in, 2.75 in, 2.756 in, 3.25 in, 4.5 in, 4.724 in, 4.75 in, 8 in, 10 in, 12 in

Overall Length (Metric): 4.4 cm, 6 cm, 7 cm, 8.5 cm, 12 cm, 20 cm, 25 cm, 30 cm, 70 mm

Overall Width (Imperial): 1.75 in, 2.362 in, 2.375 in, 2

3M™ Littmann® Classic III™ Stethoscope

Details

Monitor and assess a wide range of patients
Detect normal and abnormal sounds and rhythms
Useful in non-critical care environments such as a medical office, general ward, OB/GYN, ambulatory clinic or urgent care
5-year warranty
Fun and vibrant; match

Typical properties

Application: Patient Monitoring, Physical Assessment and Blood Pressure, Physical Assessment and Diagnosis
Approved Environmental Marketing Claim (EMC): 3M™ Littmann® tubing does not contain phthalate plasticizers. It improves resistance to skin oils and alcohol, and is less likely to pick up stains. 3M™ Littmann® tubing does not contain phthalate plasticizers. It provides longer stethoscope life due to improved resistance to skin oils and alcohol, and is less likely to pick up stains.
Binaural Construction: Single lumen
Brands: Littmann®
Catalog Number: 5646,5647
Chestpiece Color: Black, Champagne, Copper, High Polish Mirror, Rainbow, Silver, Smoke
Chestpiece Finish: Copper, High Polish, Machined Stainless Steel, Matte, Mirror
Chestpiece Size: 1.3 Inch / 3.3 cm, 1.7 Inch / 4.3 cm
Chestpiece Technology: Double-sided
Chestpiece Weight: 2.9 Ounce
Chestpiece Weight (Metric): 82 g
Cladimed Code: K50BE01
Diaphragm Diameter (Imperial): 1.7 in
Diaphragm Diameter (Metric): 4.3 cm, 4.3 mil
Diaphragm Material: Epoxy/Fiberglass
Diaphragm Shape: Round
Diaphragm Type: Tunable, single-piece
Eartip Type: Soft Sealing
Environmental claim being made: Yes
Environmental claim relates to: Product
Evidence for Claim: Self Certified
Extra Eartips: Yes
Factory ISO Certification: No ISO Certification information available
Headset Finish: Black, Smoke, Stainless
Headset Material: Anodized Aluminum
Model: Classic III™
Net Weight (Imperial): 0.33 lb, 5.3 oz
Net Weight (Metric): 150 g
Occupation: EMT/EMS, Medical Assistant, Nurse, Nursing Student, Respiratory Specialist, Teacher/Professor/Instructor
Patient: Adult
Performance: 8

Product Type: Stethoscope
Small Diaphragm Diameter: 1.3 in
Small Diaphragm Diameter (Metric): 3.3 cm, 3.3 mil
Special Adaptors: No, Yes
Tube Color: Black, Burgundy, Caribbean Blue, Ceil Blue, Champagne Rose,
Chocolate, Gray, Lavender, Lemon-Lime, Lime Green, Marine Blue, Navy Blue,
Pearl pink, Plum, Raspberry, Turquoise
Tube Construction: Single lumen
Tunable Diaphragm: Yes
Units per Pack: 1
Warranty Period: 5 yr
eClass 14 Classification Group: 34340191

Dimensions and Classifications

Overall Diameter (Imperial): 1.7 in
Overall Diameter (Metric): 4.3 cm, 4.3 mm
Overall Length (Imperial): 27 in
Overall Length (Metric): 69 cm

3M™ Scotchpak™ Release Liner Fluorosilicone Coated Polyester Film, 9709, Config Roll

3M ID 7100119905

Details

Transparent
Occlusive
Excellent chemical stability
Fluoropolymer release coating applied to one side
Manufactured for use in pharmaceutical products

Typical properties

Brands: Scotchpak™
Caliper: 3.0 mils
Caliper (Metric): 76 µm
Elongation CD: 1.5
Elongation MD: 1.5
Factory ISO Certification: No ISO Certification information available
Product Color: Transparent
Sample Roll: 6 in x 25 yds
Sample Roll (Metric): 15 cm x 23 m
Tensile CD: 72 lbs/in
Tensile CD (Metric): 320N/25.4mm
Tensile MD: 72 lbs/in
Tensile MD (Metric): 320N/25.4mm
eClass 14 Classification Group: 15360503

Dimensions and Classifications

Overall Thickness (Metric): 76 micron

3M™ Medipore™ +Pad Soft Cloth Adhesive Wound Dressing, 3500 Series

Details

Enhances patient comfort – Soft, porous and breathable. Unique, non-adherent pad won't stick to the wound, thus minimizing disruption of the healing tissues upon removal

Helps support healing – Absorbent pad protects wound and absorbs drainage, while all

Typical properties

Brands: Medipore™

Catalog Number: 3569,3568,3566,3564,3573,3562,3571,3570

Clinical Area: Cardiovascular, Critical Care, Dialysis Centre, Emergency Medical Services (EMS), Emergency Room, I.V. Therapy, Intensive Care, Pediatric, Radiology, Surgery

Clinical Sub-Area: Obstetrics and Gynaecology, Orthopedics

Condition: I.V. Related, Pressure Ulcer, Wound Care

Department: Cardiovascular, Dialysis Center, EMERGENCY, Intensive Care Unit, Labor & Delivery, Medical-Surgical, Oncology, Operating Room-Surgery, Orthopedics, Pediatrics, Radiology, Urgent Care, Wound Care

Dressing Type: Composite

Factory ISO Certification: No ISO Certification information available

Hypoallergenic: Yes

IV Related Condition Type: Arterial Catheter, CVC Dialysis, CVC PICC, CVC Short-Term, CVC Tunneled

Inner Packs per Case: 4 Cartons per Case

Latex: No

Product Color: White

Product Type: Island

Total Units per Case: 100 per Case, 200 per Case

Units per Inner Pack: 25 per Carton, 50 per Carton

Waterproof: No

eClass 14 Classification Group: 34400201

Dimensions and Classifications

Overall Length (Imperial): 2.75 in, 4 in, 6 in, 8 in, 10 in, 13.75 in

Overall Length (Metric): 6.98 cm, 10 cm, 10.16 cm, 15.24 cm, 20.32 cm, 25.4 cm, 34.92 cm

Overall Width (Imperial): 2 in, 2.375 in, 3 in, 3.5 in, 6 in

Overall Width (Metric): 5.08 cm,

3M™ Tegaderm™ Silicone Border Foam Dressing

Details

Advanced adhesive allows for “lift and check” interval monitoring
Innovative spoke delivery system enables accurate, easy application with gloved hands for a more positive clinician experience
Unique multi-layer design absorbs and evaporates moisture wh

Typical properties

Adhesive: Yes
Adhesive Type: Silicone
Backing Material: Foam
Body Part: Elbow, Heel, Sacrum
Border: Yes
Boxes per Case: 4.0,6.0
Brands: Tegaderm™
Breathable: Yes
Catalog Number: 90640,90642,90641,90643,90646,90648,90647
Condition: Dressing & Device Securement, Pressure Ulcer, Wound Care
Department: Home Care, Long-Term Care, Wound Care
Dressing and Device Securement Condition Type: Wounds
Factory ISO Certification: No ISO Certification information available
Hypoallergenic: No
Inner Packs per Case: 4 Cartons per Case, 6 Cartons per Case
Latex: No
Product Type: Foam Dressing
Shape: Rectangular, Square
Size: Large, Small
Sterile: Yes
Therapeutic Area and Conditions: Arterial ulcer, Donor Sites, Pressure Ulcers, Superficial Partial Thickness Burns, Surgical Wounds, Venous Leg Ulcer
Total Units per Case: 20 per Case, 40 per Case, 60 per Case
Units per Case: 60.0,40.0,20.0
Units per Inner Pack: 5 per Carton, 10 per Carton
Units per Pack: 5 , 10
Wound Care Condition Type: Venous Leg Ulcer
Wound Dressing Length (Imperial): 1.457 in, 2.323 in, 4.055 in, 8.661 in
Wound Dressing Length (Metric): 3.7 cm, 5.9 cm, 10.3 cm, 22 cm
Wound Dressing Width (Imperial): 1.457 in, 2.323 in, 4.055 in, 7.283 in
Wound Dressing Width (Metric): 3.7 cm, 5.9 cm, 10.3 cm, 22 cm
eClass 14 Classification Group: 34210409

Dimensions and Classifications

Overall Length (Imperial): 2 in, 3 in, 4 in, 6 in, 6.5 in, 6.75 in, 8.74 in
Overall Length (Metric): 5.08 cm, 7.62 cm, 10.16 cm, 15.24 cm, 16.5 cm, 17.145 cm, 22.225 cm
Overall Width (Imperial): 2 in, 3 in, 4 in, 6 in, 6.5 in, 7.25 in
Overall Width (Me

3M™ Littmann® Classic II Infant Stethoscope

Details

Dual-sided chestpiece with small 2.7cm diaphragm is ideal for pediatric patients
Versatile chestpiece design provides high acoustic sensitivity with both a floating diaphragm and open bell
Non-chill rim and diaphragm provide patient comfort
Soft-sealin

Typical properties

Application: Infant, Patient Monitoring, Physical Assessment and Blood Pressure, Physical Assessment and Diagnosis
Approved Environmental Marketing Claim (EMC): 3M™ Littmann® tubing does not contain phthalate plasticizers. It improves resistance to skin oils and alcohol, and is less likely to pick up stains.
Binaural Construction: Single lumen
Brands: Littmann®
Chestpiece Color: Rainbow, Silver
Chestpiece Finish: Machined Stainless Steel
Chestpiece Size: 0.75 Inch / 1.9 cm, 1.06 Inch / 3.3 cm
Chestpiece Technology: Double-sided
Chestpiece Weight: 1.05 Ounce
Chestpiece Weight (Metric): 30 g
Cladimed Code: K50BE01
Diaphragm Diameter (Imperial): 1.06 in
Diaphragm Diameter (Metric): 2.7 cm
Diaphragm Material: Epoxy/Fiberglass
Diaphragm Shape: Round
Diaphragm Type: Floating Diaphragm
Eartip Type: Soft Sealing
Environmental claim being made: Yes
Environmental claim relates to: Product
Evidence for Claim: Self Certified
Extra Eartips: No
Factory ISO Certification: No ISO Certification information available
Headset Material: Anodized Aluminum
Model: Infant
Net Weight (Imperial): 0.21 lb
Net Weight (Metric): 95 g
Occupation: NICU Nurse, Nurse, Pediatrician
Patient: Infant, Neonatal
Performance: 7
Product Type: Stethoscope
Small Diaphragm Diameter: 0.75 in, 1.3 in
Small Diaphragm Diameter (Metric): 1.9 cm, 3.3 cm
Special Adaptors: No
Tube Color: Black, Caribbean Blue, Raspberry, Red
Tube Construction: Single lumen
Tunable Diaphragm: No

Units per Pack: 1
Warranty Period: 3 yr
eClass 14 Classification Group: 34340191

Dimensions and Classifications

Overall Diameter (Metric): 1.06 cm
Overall Length (Imperial): 28 in
Overall Length (Metric): 71 cm

3M™ Littmann® Master Cardiology™ Stethoscope

Details

Outstanding acoustics: The highest in Littmann mechanical stethoscopes

Tunable diaphragm: Hear high or low frequency sounds by slightly adjusting pressure on the chestpiece

Dual-lumen tubing: Two sound paths in one tube eliminates the rubbing noise of t

Typical properties

Application: Cardiology/High Performance, Diagnostic Auscultation, Patient Monitoring, Physical Assessment and Blood Pressure, Physical Assessment and Diagnosis

Approved Environmental Marketing Claim (EMC): 3M™ Littmann® tubing does not contain phthalate plasticizers. It improves resistance to skin oils and alcohol, and is less likely to pick up stains.

Binaural Construction: Double Lumen

Brands: Littmann®

Chestpiece Color: Black, Silver, Smoke

Chestpiece Finish: Brass, Machined Stainless Steel, Matte, Polished Stainless Steel

Chestpiece Size: 2 Inch / 5.1 cm

Chestpiece Technology: Single-sided

Chestpiece Weight: 3.2 Ounce

Chestpiece Weight (Metric): 90 g

Cladimed Code: K50BE01

Diaphragm Diameter (Imperial): 2 in

Diaphragm Diameter (Metric): 5.1 cm

Diaphragm Material: Epoxy/Fiberglass

Diaphragm Shape: Round

Diaphragm Type: Tunable Diaphragm

Eartip Type: Soft Sealing

Environmental claim being made: Yes

Environmental claim relates to: Product

Evidence for Claim: Self Certified

Extra Eartips: No

Factory ISO Certification: No ISO Certification information available

Headset Material: Anodized Aluminum

Model: Master Cardiology™

Net Weight (Imperial): 0.41 lb

Net Weight (Metric): 185 g

Occupation: Advanced Registered Practice Nurse, Anesthesiologist, Cardiologist, Critical Care Nurse, EMT/EMS, Emergency Physician, Family Practitioner, Gastroenterologist, Hospitalist, Intensivist, Internist, Medical Student, Nurse, Obstetrician, Osteopath, Pediatrician, Physician, Physician Assistant, Pulmonologist, Respiratory Specialist, Teacher/Professor/Instructor, Veterinarian

Patient: Adult, Infant, Pediatric

Performance: 10

Product Type: Stethoscope

Tube Color: Black, Burgundy, Navy Blue, Plum

Tube Construction: Double Lumen
Tunable Diaphragm: Yes
Units per Pack: 1
Warranty Period: 7 yr
eClass 14 Classification Group: 34340191

Dimensions and Classifications

Overall Length (Imperial): 27 in
Overall Length (Metric): 69 cm

3M™ Red Dot™ ECG Monitoring Electrodes, 2231, 2.2 inch x 2 inch (5,1cm x 5,5cm), 50 ea/Bag, 20 Bag/Case

3M ID 7100212808 UPC 00707387788865

Details

Solid gel conforms to the skin quickly allowing high quality, uninterrupted traces
The gel's low chloride content minimizes skin irritation for increased patient comfort

Use of built-in abrader disc improves trace quality for better results (on 2271 mod

Typical properties

Age Group: Adult

Brands: Red Dot™

Case Packaging: 50 Electrodes/Bag; 20 Bags or 1000 Electrodes/Case

Clinical Area: Critical Care, Emergency Medical Services (EMS), Emergency Room, Intensive Care, Pediatric, Physician Office, Surgery

Clinical Sub-Area: Orthopedics

Department: Cardiac Rehab, Cath Lab, ICU/CCU

Electrode Size: 2.2" x 2"

Electrode Type: Diaphoretic, Fluid Resistant, Monitoring

Factory ISO Certification: No ISO Certification information available

Gel Type: Solid

Material: Soft Cloth

Model: 2231

Monitoring Event: Echo-Cardio, Stress Test, Telemetry/Holter/Event

Package Contents: 50 Electrodes/Bulk Bag

Patient: Adult

Pre-wired: No

Product Type: Electrode

Product Type Free Format: Electrode

Product Use: Diaphoretic, Monitoring

Radiolucency: Radiopaque

Skin Prep Included: No

Skin Type: Diaphoretic, Normal

Solution: Diaphoretic, Fluid Resistant, Monitoring

Wear Time: Up to Three Days

eClass 14 Classification Group: 34580108

Dimensions and Classifications

Overall Length (Imperial): 2.2 in

Overall Length (Metric): 5.5 cm

Overall Width (Imperial): 2 in

Overall Width (Metric): 5.1 cm

FUTURO™ Compression Stabilizing Wrist Brace, 48400ENR, Right Hand, Small/Medium

3M ID 70007017612 UPC 00051131200609

Details

Provides moderate support to injured wrists
Three straps provide a customizable fit
Allows your fingers to move naturally
Easy-to-use design
Supported by our expert panel of engineers and medical professionals
Size: Left Hand – S/M, L/XL Right Hand –

Typical properties

Body Part: Wrist
Brands: FUTURO™
Condition: Arthritis, Carpal Tunnel Syndrome, Pinched Nerve, Repetitive Stress Injury, Sprains, Strains, Swelling, Tendonitis, Thumb Hyperextension
Factory ISO Certification: No ISO Certification information available
Fit Range: S/M fits: 5.5" to 6.75"
L/XL fits: 6.75" to 8.5"
Material: Aluminum, Nylon, Polyester, Polyurethane, Silicone, Spandex
Product Color: Black
Product Type: Support
Product Use: General Support, Sprains, Strains, Symptoms of Carpal Tunnel Syndrome
Size: Small/Medium
Sizes Available: Right Hand - S/M
Support Level: Moderate
Support and Compression Level: Moderate
Type: Brace
Where to Measure: Measure around wrist at smallest point.
eClass 14 Classification Group: 34200201

FUTURO™ Compression Stabilizing Wrist Brace, 48403ENR Left Hand, Large/Extra-Large

3M ID 70007017646 UPC 00051131201583

Details

Provides moderate support to injured wrists
Three straps provide a customizable fit
Allows your fingers to move naturally
Easy-to-use design
Supported by our expert panel of engineers and medical professionals
Size: Left Hand – S/M, L/XL Right Hand –

Typical properties

Body Part: Wrist
Brands: FUTURO™
Condition: Arthritis, Carpal Tunnel Syndrome, Pinched Nerve, Repetitive Stress Injury, Sprains, Strains, Swelling, Tendonitis, Thumb Hyperextension
Factory ISO Certification: No ISO Certification information available
Fit Range: S/M fits: 5.5" to 6.75"
L/XL fits: 6.75" to 8.5"
Material: Aluminum, Nylon, Polyester, Polyurethane, Silicone, Spandex
Product Color: Black
Product Type: Brace
Product Use: General Support, Sprains, Strains, Symptoms of Carpal Tunnel Syndrome
Size: Large/X-Large
Sizes Available: Left Hand - L/XL
Support Level: Moderate
Support and Compression Level: Moderate
Type: Brace
Where to Measure: Measure around wrist at smallest point.
eClass 14 Classification Group: 34200201

FUTURO™ Compression Stabilizing Wrist Brace, 48401ENR, Left Hand, Small/Medium

3M ID 70007017620 UPC 00051131200593

Details

Provides moderate support to injured wrists
Three straps provide a customizable fit
Allows your fingers to move naturally
Easy-to-use design
Supported by our expert panel of engineers and medical professionals
Size: Left Hand – S/M, L/XL Right Hand –

Typical properties

Body Part: Wrist
Brands: FUTURO™
Condition: Arthritis, Carpal Tunnel Syndrome, Pinched Nerve, Repetitive Stress Injury, Sprains, Strains, Swelling, Tendonitis, Thumb Hyperextension
Factory ISO Certification: No ISO Certification information available
Fit Range: S/M fits: 5.5" to 6.75"
L/XL fits: 6.75" to 8.5"
Material: Aluminum, Nylon, Polyester, Polyurethane, Silicone, Spandex
Product Color: Black
Product Type: Support
Product Use: General Support, Sprains, Strains, Symptoms of Carpal Tunnel Syndrome
Size: Small/Medium
Sizes Available: Left Hand - S/M
Support Level: Moderate
Support and Compression Level: Moderate
Type: Brace
Where to Measure: Measure around wrist at smallest point.
eClass 14 Classification Group: 34200201

FUTURO™ Compression Stabilizing Wrist Brace, 48402ENR, Right Hand, Large/Extra-Large

3M ID 70007017638 UPC 00051131201576

Details

Provides moderate support to injured wrists
Three straps provide a customizable fit
Allows your fingers to move naturally
Easy-to-use design
Supported by our expert panel of engineers and medical professionals
Size: Left Hand – S/M, L/XL Right Hand –

Typical properties

Body Part: Wrist
Brands: FUTURO™
Condition: Arthritis, Carpal Tunnel Syndrome, Pinched Nerve, Repetitive Stress Injury, Sprains, Strains, Swelling, Tendonitis, Thumb Hyperextension
Factory ISO Certification: No ISO Certification information available
Fit Range: S/M fits: 5.5" to 6.75"
L/XL fits: 6.75" to 8.5"
Material: Aluminum, Nylon, Polyester, Polyurethane, Silicone, Spandex
Product Color: Black
Product Type: Brace
Product Use: General Support, Sprains, Strains, Symptoms of Carpal Tunnel Syndrome
Size: Large/X-Large
Sizes Available: Right Hand - L/XL
Support Level: Moderate
Support and Compression Level: Moderate
Type: Brace
Where to Measure: Measure around wrist at smallest point.
eClass 14 Classification Group: 34200201

Stethoscope Identification Tag

Details

I.D. tag provides easy identification of stethoscope
Mail-order engraving service information included with I.D. tag for easy, high-quality engraving option

Typical properties

Brands: Littmann®
Cladimed Code: K50BE02
Factory ISO Certification: No ISO Certification information available
Kit Includes: Identification Tag
Model: All Stethoscopes
Product Color: Black, Gray
Product Type: Identification Tag
eClass 14 Classification Group: 34340191

3M™ Steri-Drape™ Hand Drape, 20 per Case, 9052NS

3M ID 7000053708 UPC 00707387561253

Details

Superior Strength and Comfort
Impervious to Strikethrough
Fluid Control Features

Typical properties

Brands: Steri-Drape™
Factory ISO Certification: No ISO Certification information available
Product Type: Hand Drape
Product Use: Procedure Specific

Dimensions and Classifications

Overall Length (Metric): 200 cm
Overall Width (Metric): 360 cm

3M™ Steri-Drape™ TUR Pack 1081P, 7 per Carton / 2 Cartons per Case

3M ID 7000030258 UPC 00707387563288

Details

Fluid Control Features
Resistent to Strikethrough

Typical properties

Brands: Steri-Drape™
Cladimed Code: E51AH03
Factory ISO Certification: No ISO Certification information available
Product Type: TUR Pack
Product Use: Urology

3M™ Steri-Drape™ TUR Pack, 7 per Carton / 2 Cartons per Case, 1081PD

3M ID 7000053875 UPC 00707387582234

Details

Fluid Control Features
Resistent to Strikethrough

Typical properties

Additional Drapes: Pack
Brands: Steri-Drape™
Factory ISO Certification: No ISO Certification information available
Product Type: TUR Pack
Units per Pack: 7

3M™ Steri-Drape™ Shoulder Arthroscopy Pack, 5 per Carton / 2 Cartons per Case, 9196P

3M ID 7000053777 UPC 00707387568054

Details

Superior Strength and Comfort
Reliable, dependable adhesive
Reliable Adhesion

Typical properties

Additional Drapes: Pack
Brands: Steri-Drape™
Cladimed Code: E51AG09
Factory ISO Certification: No ISO Certification information available
Product Type: Arthroscopy Pack
Product Use: Procedure Specific
Units per Pack: 5

3M™ Steri-Drape™ Arthroscopy Pack, 4 per Carton / 2 Cartons per Case, 1194P

3M ID 7000053776 UPC 00707387568047

Details

Resistant to Strikethrough
Impervious to Strikethrough
Reliable Adhesion

Typical properties

Additional Drapes: Pack
Brands: Steri-Drape™
Cladimed Code: E51AG02
Factory ISO Certification: No ISO Certification information available
Product Type: Arthroscopy Pack
Product Use: General Surgery
Units per Pack: 4

Dimensions and Classifications

Overall Length (Metric): 304 cm
Overall Width (Metric): 292 cm

3M™ Steri-Drape™ Head and Neck Pack, 10 per Carton / 2 Cartons per Case, 9009

3M ID 7000053866 UPC 00707387581565

Details

1 OP Tape, 2 Non Adhesive Drape Sheets, 1 Adhesive Drape Sheet, 1 Back Table Cover

Resistant to Strikethrough

Fluid Control Features

Fluid Control Features

Typical properties

Additional Drapes: Pack

Brands: Steri-Drape™

Factory ISO Certification: No ISO Certification information available

Product Type: Fabric Drapes

Product Use: Procedure Specific

Units per Pack: 10

3M™ Steri-Drape™ Head and Neck Pack 9008, 7 per Carton / 2 Cartons per Case

3M ID 7000030238 UPC 30707387561148

Details

1 9099 OP Tape, 4 Hand Towels, 1 9035 Mayo Stand Cover, 1 9070 Turban
Drape Sheet, 1 9044 Adhesive Split Sheet, 1 9077 Back Table Cover
Resistant to Strikethrough
Fluid Control Features
Fluid Control Features

Typical properties

Brands: Steri-Drape™
Factory ISO Certification: No ISO Certification information available
Product Type: Fabric Drapes
Product Use: Procedure Specific
Units per Pack: 7

3M™ Steri-Drape™ Orthopaedic Surgical Pack 9012, 5 per Carton / 2 Cartons per Case

3M ID 7000030181 UPC 50707387456004

Details

1 9099 OP Tape, 4 Hand Towels, 1 9035 Mayo Stand Cover, 1 9042 Extremity
Cover, 1 9087 Adhesive Drape Sheet (M), 1 9045 Adhesive Split Sheet, 1 9088
Adhesive Drape Sheet (L), 1 9077 Back Table Cover

Resistant to Strikethrough

Fluid Control Features

F

Typical properties

Additional Drapes: Pack

Brands: Steri-Drape™

Cladimed Code: E51AG04

Factory ISO Certification: No ISO Certification information available

Product Type: Orthopedic Pack

Product Use: General Surgery

Units per Pack: 5

3M™ Steri-Drape™ Orthopaedic Surgical Pack, 9051, 183 cm x 315 cm, 15/Case, 2/Case

3M ID 7000002778 UPC 30707387560431

Details

Resistant to Strikethrough
Reliable, dependable adhesive
Fluid Control Features
Reliable, dependable adhesive (around aperture, etc.) stays secure throughout the procedure

Typical properties

Brands: Steri-Drape™
Cladimed Code: E51BD02
Factory ISO Certification: No ISO Certification information available
Loophole Length (Metric): 12 cm
Loophole Width (Metric): 12 cm
Model: 9051
Procedure: General Surgery
Product Color: Blue
Product Type: Thyroid Drape
Product Type Free Format: Drape
Product Use: EENT
Therapeutic Area and Conditions: General Surgery, Head and Neck
Units per Pack: 15

Dimensions and Classifications

Overall Length (Imperial): 124 in
Overall Length (Metric): 315 cm
Overall Width (Imperial): 72 in
Overall Width (Metric): 183 cm

3M™ Steri-Drape™ Orthopaedic Pack 9012L, 4 per Carton / 2 Cartons per Case

3M ID 7000030211 UPC 50707387507522

Details

Superior Strength and Comfort
Reliable Adhesion
Reliable Adhesion

Typical properties

Additional Drapes: Pack
Brands: Steri-Drape™
Cladimed Code: E51AG04
Factory ISO Certification: No ISO Certification information available
Product Color: Blue
Product Type: Surgical Pack
Product Use: Orthopedics
Units per Pack: 4

3M™ Steri-Drape™ Orthopaedic Surgical Pack 9012A

3M ID 7000002782 UPC 30707387560493

Details

Move to attributes
Resistant to Strikethrough
Fluid Control Features

Typical properties

Additional Drapes: Pack
Brands: Steri-Drape™
Factory ISO Certification: No ISO Certification information available
Model: 9012A
Procedure: Orthopedic
Product Type: Surgical Pack
Product Use: Orthopedics

**3M™ Steri-Drape™ Lithotomy Pack with Under Buttocks Drape, 7 per Carton
/ 2 Cartons per Case, 9105**

3M ID 7000053862 UPC 00707387581527

Details

1 Under Buttocks Drape with Cuff, 2 Leggings, 1 Adhesive Drape Sheet, 1 Back Table Cover

Resistant to Strikethrough

Fluid Control Features

Reliable, dependable adhesive

Reliable, dependable adhesive (around aperture, etc.) stays secure throughout th

Typical properties

Additional Drapes: Pack

Brands: Steri-Drape™

Cladimed Code: E51AH04

Factory ISO Certification: No ISO Certification information available

Product Color: Blue

Units per Pack: 7

**3M™ Steri-Drape™ Lithotomy Pack with Pouch, 7 per Carton / 2
Cartons per
Case, 9106**

3M ID 7000053863 UPC 00707387581534

Details

1 Under Buttocks Drape with Pouch, 2 Leggings, 1 Adhesive Drape Sheet, 1
Back Table Cover
Resistant to Strikethrough
Fluid Control Features
Reliable, dependable adhesive
Reliable, dependable adhesive (around aperture, etc.) stays secure throughout t

Typical properties

Additional Drapes: Pack
Brands: Steri-Drape™
Factory ISO Certification: No ISO Certification information available
Units per Pack: 7

3M™ Bair Hugger™ Booties

Details

Can help keep patients comfortable
Convenient

Typical properties

Brands: Bair Hugger™
Clinical Area: OR, PACU, Pre-op
Factory ISO Certification: No ISO Certification information available
Gown Size: Extra Large, Standard
Hardware: Accessory
Model: 90065, 90091
Product Type: Bootie
Quantity: 30 Case
Units per Pack: 30
eClass 14 Classification Group: 34540392

3M™ Bair Hugger™ Flex Warming Gown with Booties 83003, Standard, 30/Case

3M ID 7100087555 UPC 50707387774443

Details

Two inserts allow for greater warming flexibility: upper, torso or lower body warming; clinical or comfort warming

Patients reach the OR ready to warm with warming tools built right into the gown including a head drape, tie strips and a patient adhesive

Typical properties

Brands: Bair Hugger™

Clinical Area: OR, PACU, Pre-op

Factory ISO Certification: No ISO Certification information available

Model: 83003

Product Type: Gown/Bootie

Quantity: 30 Case

Size: Standard

Style: Flex Gown

Sweep: 64 in +/- 1

Sweep (Metric): 163

eClass 14 Classification Group: 34540392

Dimensions and Classifications

Overall Length (Imperial): 51 in

Overall Length (Metric): 130 cm

3M™ Skin and Nasal Antiseptic, 192401

Details

3M™ Skin and Nasal Antiseptic:

A pH-balanced formulation with a scientifically developed film-forming polymer to increase persistence

Helps improve patient safety and protocol compliance without alcohol or antibiotics

More effective than 10% povidone-i

Typical properties

Antiseptic Agent: PVP-I

Application: Nasal Decolonization

Brands: 3M™

Factory ISO Certification: No ISO Certification information available

Model: 192401

Product Type: Swab

Product Use: Pre-surgical

eClass 14 Classification Group: 34210190

3M™ Bair Hugger™ Flex Warming Gown

Details

Two inserts allow for greater warming flexibility: upper, torso or lower body warming; clinical or comfort warming
Patients reach the OR ready to warm with warming tools built right into the gown including a head drape, tie strips and a patient adhesive

Typical properties

Brands: Bair Hugger™
Clinical Area: Surgery
Clinical Sub-Area: Post Anesthetic Care Unit
Factory ISO Certification: No ISO Certification information available
Gown Circumference (Metric): 163 cm
Model: 81003, 81103, 81203
Product Type: Gown
Quantity: 20 Case, 30 Case
Size: Small, Standard, X-Large
Style: Flex Gown
Sweep: 122 in +/- 1, 55 in +/- 1, 64 in +/- 1
Sweep (Metric): 163 , 310
Units per Pack: 20 , 30
eClass 14 Classification Group: 34540392

Dimensions and Classifications

Overall Length (Imperial): 44 in, 51 in
Overall Length (Metric): 111 cm, 130 cm

3M™ Bair Hugger™ + Warming Gown Kit

Details

Provides comfort and clinical warming throughout perioperative process
Eliminates the need to reposition the gown in many procedures by providing one hose port for prewarming or comfort warming, and two hose ports for clinical warming
Can improve patient

Typical properties

Brands: Bair Hugger™
Clinical Area: OR, PACU, Pre-op
Closure Style: Tie Neck & Back
Factory ISO Certification: No ISO Certification information available
Gown Size: Extra Large
Model: 84002, 84202
Product Type: Gown, Gown Kit
Quantity: 20 Case, 30 Case
Reusable: No
Size: Standard, X-Large
Style: Plus Gown
Sweep: 122 in +/- 1, 64 in +/- 1
Sweep (Metric): 163 , 310
eClass 14 Classification Group: 34540392

Dimensions and Classifications

Overall Length (Imperial): 51 in
Overall Length (Metric): 130 cm
Overall Width (Metric): 130 cm

3M™ Bair Hugger™ Warming Blanket, 422xx

Details

Single-use upper-body forced-air warming blanket with excellent heat transfer
Consists of a soft, comfortable, lightweight material
Helps maintain normothermia, which has been shown to reduce the rate of complications such as surgical site infection (SS

Typical properties

Application: Medical
Blanket Type: Upper Body
Brands: Bair Hugger™
Clinical Area: OR
Drape Length: 24 in
Drape Length (Metric): 61 cm
Drape Width: 24 in
Drape Width (Metric): 61 cm
Factory ISO Certification: No ISO Certification information available
Product Type: Blanket
Product Use: OR
Quantity: 10 Case
Total Units per Case: 10 per Case
eClass 14 Classification Group: 34540392

Dimensions and Classifications

Overall Length (Imperial): 74 in
Overall Length (Metric): 188 cm
Overall Width (Imperial): 24 in
Overall Width (Metric): 61 cm

3M™ Bair Hugger™ Warming Blanket, 425xx

Details

Single-use upper-body forced-air warming blanket for excellent heat transfer
Effectively used for patients in supine, lateral or prone positions
Foot drape minimizes risk of thermal injury to the feet and lower leg area
Continuous adhesive strip secure

Typical properties

Application: Medical
Blanket Type: Lower Body
Brands: Bair Hugger™
Clinical Area: OR
Factory ISO Certification: No ISO Certification information available
Product Type: Blanket
Product Use: OR
Quantity: 10 Case
Total Units per Case: 10 per Case
eClass 14 Classification Group: 34540392

Dimensions and Classifications

Overall Length (Imperial): 60 in
Overall Length (Metric): 152 cm
Overall Width (Imperial): 36 in
Overall Width (Metric): 91 cm

3M™ Bair Hugger™ Warming Blanket 53700, Small Lower Body, 10/Case

3M ID 7100212594 UPC 50707387790115

Details

Single-use lower-body forced-air warming blanket with excellent heat transfer
Can also be used as a full-body warming blanket on smaller patients
Consists of a soft, comfortable, lightweight material
Perforations across the blanket provide uniform conv

Typical properties

Application: Medical
Blanket Type: Lower Body
Brands: Bair Hugger™
Cladimed Code: Non applicable
Clinical Area: Cardiac & Specialty, OR, Pediatric
Factory ISO Certification: No ISO Certification information available
Product Type: Blanket
Quantity: 10 Case
Total Units per Case: 10 per Case
Units per Pack: 10
eClass 14 Classification Group: 34540392

Dimensions and Classifications

Overall Length (Imperial): 35 in
Overall Length (Metric): 61 cm
Overall Width (Imperial): 24 in
Overall Width (Metric): 89 cm

3M Scotchpak™ 9723 Backing Tan Polyester Film Laminate

3M ID 70000064561

Details

Tan
Occlusive
Printable
Not corona treated
Matte finish on one side
Can be directly laminated to adhesives

Typical properties

Backing (Carrier) Material: Polyester
Brands: Scotchpak™
Breathability: Occlusive
Caliper: 1.66 mils
Caliper (Metric): 42.2 µm
Catalog Number: 9723
Elongation CD: 50%
Elongation MD: 75%
Factory ISO Certification: No ISO Certification information available
MVTR (g/m²/24 hr): 10
Oxygen Transmission (cc/m²/24hr): 100
Product Color: Tan
Product Type: Transdermal Backing
Sample Roll: 6 in x 25 yds
Sample Roll (Metric): 15 cm x 23 m
Tensile CD: 20 lbs/in
Tensile CD (Metric): 89 N/25.4 mm
Tensile MD: 15 lbs/in
Tensile MD (Metric): 66.7 N/25.4 mm
eClass 14 Classification Group: 41011103

Dimensions and Classifications

Overall Length (Imperial): 1500 yd
Overall Length (Metric): 1372 m
Overall Thickness (Imperial): 1.66 mil
Overall Thickness (Metric): 42.2 micron
Overall Width (Metric): 102 cm

3M™ CoTran™ Melt-blown Polyurethane Nonwoven Backing Film, 9700, Configurable

3M ID 7100045177

Details

Tan
Breathable
Highly conformable
Provided on a carrier

Typical properties

Backing (Carrier) Material: Polyurethane
Brands: CoTran™
Breathability: Breathable
Caliper: 9 mils
Caliper (Metric): 228 µm
Catalog Number: 9700
Elongation CD: 300%
Elongation MD: 300%
Factory ISO Certification: No ISO Certification information available
Liner Caliper (Metric): 127 µm
Liner Caliper (mils): 5 mil
Liner Release: ≤200 g/in
Liner Release (Metric): ≤1.96 N/25.4 mm/in
MVTR (g/m²/24 hr): 8408
Oxygen Transmission (cc/m²/24hr): N/T
Product Color: Tan
Product Type: Transdermal Backing
Sample Roll: 6 in x 25 yds
Sample Roll (Metric): 15 cm x 23 m
Tensile CD: 3.5 lbs/in min.
Tensile CD (Metric): 15.6 N/25.4 mm min.
Tensile MD: 4.3 lbs/in min.
Tensile MD (Metric): 19.1 N/25.4 mm min.
eClass 14 Classification Group: 41011103

Dimensions and Classifications

Overall Length (Imperial): 546.807 yd
Overall Length (Metric): 500 m
Overall Width (Imperial): 400 in
Overall Width (Metric): 48 cm

3M™ Medical Tape 9860, Single Sided Polyester, 63# liner, Configurable

3M ID 7100070637

Details

Tackified Acrylic Adhesive
Fluid Resistant
Good Processability

Typical properties

Adhesive Material: Acrylate
Adhesive Type: Acrylic/Acrylate (Tack)
Backing Caliper: 13 mil
Backing Caliper (Metric): 330 Micron
Backing Material: Polyester
Backing Thickness (Imperial): 13 mil
Backing Thickness (Metric): 330 Micron
Brands: 3M™
Breathable: No
Conformability: Low
Factory ISO Certification: No ISO Certification information available
Fluid Resistance Backing/Carrier: Yes
Hypoallergenic: No
Latex: No
Liner Caliper (Metric): 120 Micron
Liner Caliper (mils): 4.9 mil
Liner Color: White
Liner Material: Paper
Liner Weight: 63.0 lb.
Liner Weight (Metric): 103 g/m²
Material: Polyester
Maximum Length (Metric): 366 m
Maximum Width Capacity: 48 in
Maximum Width Capacity (Metric): 1220 mm
Printable Backing: Yes
Product Color: Transparent
Product Type: Polyester, Incise & Polyurethane
Product Usage: Adhesion to Skin, Adhesion to Substrate
Sterilization Method: Ethylene Oxide (EO), Gamma, Steam
Tape Color: Transparent
Tape Total Caliper (Metric): 360.0 Micron
Tape Type: Single-sided Polyester Tape
eClass 14 Classification Group: 34180101

Dimensions and Classifications

Overall Thickness (Imperial): 11 mil
Overall Thickness (Metric): 0.36 mm
Overall Width (Imperial): 48 in

3M™ Medical Tape 9834, Single Sided Polyurethane, 78# Carrier, CONFIGURABLE

3M ID 7100013562

Details

Acrylic Adhesive
High Moisture Vapor Transmission Rate (MVTR) / Breathability
Fluid Resistant
Printable with treatment

Typical properties

Adhesive Material: Acrylate
Adhesive Type: Acrylic/Acrylate
Backing Caliper: 0.8 mil
Backing Caliper (Metric): 20 Micron
Backing Material: Polyurethane
Backing Thickness (Imperial): 0.8 mil
Backing Thickness (Metric): 20 Micron
Brands: 3M™
Breathable: Yes
Conformability: Very High
Factory ISO Certification: No ISO Certification information available
Fluid Resistance Backing/Carrier: Yes
Hypoallergenic: No
Latex: No
Liner Caliper (Metric): 130 Micron
Liner Caliper (mils): 5 mil
Liner Color: White
Liner Material: Paper
Liner Weight: 78.0 lb.
Liner Weight (Metric): 127 g/m²
Material: Polyurethane
Maximum Length (Metric): 640 m
Maximum Width Capacity: 46 in
Maximum Width Capacity (Metric): 1170 mm
Printable Backing: Yes
Product Color: Transparent
Product Type: Polyester, Incise & Polyurethane
Product Usage: Adhesion to Skin
Sterilization Method: Ethylene Oxide (EO), Gamma
Tape Color: Transparent
Tape Total Caliper: 1.8 mil
Tape Total Caliper (Metric): 50.0 Micron
Tape Type: Single-sided Polyurethane Tape
eClass 14 Classification Group: 34180101

Dimensions and Classifications

Overall Thickness (Metric): 0.05 mm

Overall Width (Imperial): 46 in
Overall Width (Metric): 116.84 cm

3M™ Steri-Vac™ Sterilizer/Aerator, GSX Series

Details

Physical parameter display on video screen
Pre-set or programmable cycle capability
Wide range of set-points for critical parameters
In-chamber timed aeration capability
Double door design for pass through
Available with left or right hinge

Typical properties

Brands: Steri-Vac™
Chamber Capacity (Imperial): 4.8 ft³, 7.9 ft³
Chamber Capacity (Metric): 136 Liter, 224 Liter
Chamber Dimensions (h x w x d) (Metric): 179.8 × 94.0 × 109.0 cm (70.8 × 37.0 × 42.9 in.), 70.9 × 76.2 × 95.0 cm (27.9 × 30.0 × 37.4 in.)
Door Configuration: Single, Double
Factory ISO Certification: No ISO Certification information available
Industries: Life Sciences
Product Type: Sterilizer
Product Use: Accessory
Sterilization Cycle: 38 °C, 270 min, 55 °C, 60 min
Sterilization Method: Ethylene Oxide (EO)
eClass 14 Classification Group: 36070101

3M™ Comply™ Sterilization Load Labels

Details

Strong label adhesive keeps label in place during sterilization, eliminating the need for relabeling

Labels available in several colors for easy color-coding by destination, department, etc

Typical properties

Brands: Comply™

Clinical Area: Medical Device Reprocessing Department

Factory ISO Certification: No ISO Certification information available

Industries: Life Sciences

Model: 1257B, 1257BL, 1257G, 1257R, 1257W, 1269B, 1269BL, 1269G, 1269R

Product Color: Black, Blue, Green, Red, White

Product Type: Label System

Product Use: Record Keeping

Units per Pack: 12

eClass 14 Classification Group: 34410209

Dimensions and Classifications

Overall Length (Imperial): 0.625 in, 1.125 in

Overall Length (Metric): 1.58 cm, 2.58 cm

Overall Width (Imperial): 0.625 in, 1.125 in

Overall Width (Metric): 1.58 cm, 2.58 cm

3M™ Comply™ Label Applicator, 1256B, 1 Each/Case

3M ID 7000002763 UPC 00707387443825

Details

Durable, lightweight applicator is easy to use
All load identification information is printed in one easy-to-read area

Typical properties

Brands: Comply™
Factory ISO Certification: No ISO Certification information available
Industries: Life Sciences
Model: 1256B
Product Color: Blue
Product Type: Label System
Product Type Free Format: Label Gun
Product Use: Record Keeping
Units per Pack: 1
eClass 14 Classification Group: 34410209

3M™ Attest™ Rapid Steam Biological Indicator Test Pack with Type 5 CI, 41382

Details

Pre-assembled, easy-to-use test pack containing a 3M™ Attest™ Rapid Readout Biological Indicator 1292, Brown Cap, 3 Hour, and a 3M™ Attest™ Steam Chemical Integrator, Type 5
Accurate BI results in 3 hours when incubated in a 3M™ Attest™ Auto-reader 390

Typical properties

Biological Indicator System: Rapid
Brands: Attest™
Cap Color: Brown
Catalog Number: 41382F,41382
Clinical Area: Medical Device Reprocessing Department
Factory ISO Certification: No ISO Certification information available
Incubation Period: 3 Hour
Inner Packs per Case: 4 Cartons per Case
Product Type: Test Pack
Product Use: Load Monitoring
Sterilization Method: Steam
Total Units per Case: 64 per Case
Units per Inner Pack: 16 per Carton
eClass 14 Classification Group: 34410601

3M™ Attest™ Super Rapid Steam Biological Indicator Challenge Pack with Type 5 CI, 41482

Details

Pre-assembled, easy-to-use steam challenge pack includes a 3M™ Attest™ Steam Chemical Integrator, Type 5, and a 3M™ Attest™ Super Rapid Readout Steam Biological Indicator 1492V, Brown Cap, 24 minute BI results in just 24 minutes
Monitors 270°F/132°C to

Typical properties

Biological Indicator System: Super Rapid
Brands: Attest™
Cap Color: Brown
Catalog Number: 41482V,41482VF
Factory ISO Certification: No ISO Certification information available
Incubation Period: 24 Minute
Inner Packs per Case: 24 Sets per Case
Product Color: White
Product Type: Challenge Pack
Product Use: Load Monitoring
Sterilization Method: Steam
Total Units per Case: 24 per Case
eClass 14 Classification Group: 34410601

3M™ Littmann® Stethoscope Floating Diaphragms, CARDIOLOGY III, W/SURROUND, Black

3M ID 7100119139 UPC 00707387783471

Details

[Back to 3M™ Littmann® Stethoscope Overview](http://www.3m.com/3M/en_US/littmann-stethoscopes-us/)
Allows for easy replacement of diaphragm
Standard diaphragm designed to listen to th

Typical properties

Brands: Littmann®
Diaphragm Diameter (Imperial): 1.378 in
Diaphragm Diameter (Metric): 35 mm
Factory ISO Certification: No ISO Certification information available
Model: Cardiology III™
Product Type: Spare Parts Kit
eClass 14 Classification Group: 34340191

3M™ Littmann® Stethoscope Floating Diaphragms, CARDIOLOGY III, W/SURROUND, Gray

3M ID 7100119175 UPC 00707387783464

Details

[Back to 3M™ Littmann® Stethoscope Overview](http://www.3m.com/3M/en_US/littmann-stethoscopes-us/)
Allows for easy replacement of diaphragm
Standard diaphragm designed to listen to th

Typical properties

Brands: Littmann®
Diaphragm Diameter (Imperial): 1.378 in
Diaphragm Diameter (Metric): 35 mm
Factory ISO Certification: No ISO Certification information available
Model: Cardiology III™
Product Type: Spare Parts Kit
eClass 14 Classification Group: 34340191

3M™ Comply™ Bowie-Dick Plus Test Pack with Early Warning Test Sheet, 00135LF, 6 Each/Bag 5 Bag/case

3M ID 7000002930 UPC 50707387584134

Details

Early warning feature of the 3M™ Comply™ Bowie-Dick Plus Test Pack 00135LF permits scheduled sterilizer maintenance and helps to prevent unexpected failures

Easy-to-read test sheet clearly identifies failures and can be filed for record keeping

Ink is n

Typical properties

Boxes per Case: 5.0

Brands: Comply™

Factory ISO Certification: No ISO Certification information available

Model: 00135LF

Product Type: Bowie-Dick

Product Use: Equipment Monitoring

Sterilization Method: Steam

eClass 14 Classification Group: 34410501

Dimensions and Classifications

Overall Length (Imperial): 5 in

Overall Length (Metric): 12.7 cm

Overall Width (Imperial): 4.375 in

Overall Width (Metric): 11.1 cm

3M™ Bair Hugger™ 700 Series Warming Unit Rolling Cart, 90090, 1 Each

3M ID 7100242309 UPC 00707387806620

Details

Pre-op, OR, PACU

Typical properties

Brands: Bair Hugger™

Cladimed Code: Non applicable

Clinical Area: OR, PACU, Pre-op

Factory ISO Certification: No ISO Certification information available

Model: 90090

Product Type: Accessory

Quantity: 1 each

Units per Pack: 1

Dimensions and Classifications

Overall Length (Imperial): 15 in

Overall Length (Metric): 40 cm

Overall Width (Imperial): 15.5 in

Overall Width (Metric): 40 cm

3M™ Medical Tape 9830, Single Sided Transparent Polyethylene, 63# Liner, Configurable

3M ID 7100012408

Details

Tackified Acrylic Adhesive
Fluid Resistant
Conformable
Good Processability

Typical properties

Adhesive Material: Acrylate
Adhesive Type: Acrylic/Acrylate (Tack)
Backing Caliper: 1.5 mil
Backing Caliper (Metric): 40 Micron
Backing Material: Low Density Polyethylene
Backing Thickness (Imperial): 1.5 mil
Backing Thickness (Metric): 40 Micron
Brands: 3M™
Breathable: No
Conformability: Very High
Factory ISO Certification: No ISO Certification information available
Fluid Resistance Backing/Carrier: Yes
Hypoallergenic: No
Liner Caliper (Metric): 120 Micron
Liner Caliper (mils): 4.9 mil
Liner Color: White
Liner Material: Paper
Liner Weight: 63.0 lb.
Liner Weight (Metric): 103 g/m²
Material: Polyethylene
Maximum Length (Metric): 548 m
Maximum Width Capacity: 48 in
Maximum Width Capacity (Metric): 1220 mm
Printable Backing: Yes
Product Color: Transparent
Product Type: Polyester, Incise & Polyurethane
Product Usage: Adhesion to Skin
Sterilization Method: Ethylene Oxide (EO), Gamma
Tape Color: Transparent
Tape Total Caliper: 2.6 mil
Tape Total Caliper (Metric): 70.0 Micron
Tape Type: Single-sided Polyethylene Tape
eClass 14 Classification Group: 34180101

Dimensions and Classifications

Overall Thickness (Imperial): 12 mil

Overall Thickness (Metric): 0.07 mm
Overall Width (Imperial): 48 in
Overall Width (Metric): 121.92 cm

3M™ Medical Tape 9948, Single Sided Thermoplastic Elastomer, 63# liner, Configurable

3M ID 7100000223

Details

Acrylic Adhesive
Breathable
Fluid Resistant
Conformable

Typical properties

Adhesive Material: Acrylate
Adhesive Type: Acrylic/Acrylate
Backing Caliper: 1 mil
Backing Caliper (Metric): 25 Micron
Backing Material: Thermoplastic Elastomer (TPE) Film
Backing Thickness (Imperial): 1 mil
Backing Thickness (Metric): 25 Micron
Brands: 3M™
Breathable: Yes
Conformability: Very High
Factory ISO Certification: No ISO Certification information available
Fluid Resistance Backing/Carrier: Yes
Hypoallergenic: No
Latex: No
Liner Caliper (Metric): 120 Micron
Liner Caliper (mils): 4.9 mil
Liner Color: White
Liner Material: Paper
Liner Weight: 63.0 lb.
Liner Weight (Metric): 103 g/m²
Material: Thermoplastic Elastomer (TPE)
Maximum Length (Metric): 594 m
Maximum Width Capacity: 48 in
Maximum Width Capacity (Metric): 1220 mm
Printable Backing: Yes
Product Color: Transparent
Product Type: Polyester, Incise & Polyurethane
Product Usage: Adhesion to Skin
Sterilization Method: Ethylene Oxide (EO), Gamma
Tape Color: Transparent
Tape Total Caliper (Metric): 70.0 Micron
Tape Type: Single-sided Thermoplastic Elastomer (TPE) Film
eClass 14 Classification Group: 34180101

Dimensions and Classifications

Overall Thickness (Imperial): 7.1 mil
Overall Thickness (Metric): 0.05 mm

Overall Width (Imperial): 48 in
Overall Width (Metric): 121.92 cm

3M™ Bair Hugger™ Pediatric Warming Gown 81501, 20/Case

3M ID 7100212581 UPC 00707387789961

Details

Refastenable strips provide quick access to the arms and chest
Side ties ensure full, secure coverage, even in the back
Dual air-channel inserts and hose ports enable prewarming and comfort warming with a Bair Hugger 800 series warming unit, or clinical

Typical properties

Brands: Bair Hugger™
Clinical Area: OR, PACU, Pre-op
Factory ISO Certification: No ISO Certification information available
Gown Size: Small
Model: 81501
Product Type: Gown
Quantity: 20 Case
Style: Pediatric Gown
Sweep: 40 in
Sweep (Metric): 101.6
Units per Pack: 20
eClass 14 Classification Group: 34540392

Dimensions and Classifications

Overall Length (Imperial): 33 in
Overall Length (Metric): 83.8 cm

3M™ Curoc™ Stopper Disinfecting Cap for Open Female Luers, CS Series

Details

Designed to luer lock onto a wide range of stopcocks and catheter hubs
Unique cap design holds pressure to maintain a closed system
Brightly colored to help clinicians verify and measure compliance
In vitro testing shows effectiveness against the six m

Typical properties

Boxes per Case: 8.0
Brands: Curoc™
Catalog Number: CSA1-270,CSA5-250
Compatible Connector: Open Female Luers
Condition: I.V. Related
Factory ISO Certification: No ISO Certification information available
Latex: No
Package Contents: Strips,Individuals
Product Color: Red
Product Type: Disinfecting Cap
Shelf Life: 2 Year
Units per Box: 250.0,270.0
Units per Case: 2160.0,2000.0
eClass 14 Classification Group: 34221209

3M™ Curox Jet™ Disinfecting Cap for Needleless Connectors, CFJ Series

Details

Disinfects in 1 minute. Protects ports for up to 7 days if not removed
Twists on easily and stays securely in place on commonly used needleless connectors

A high profile makes the Curox Jet disinfecting cap easy to handle when wearing gloves

Brightly colored

Typical properties

Brands: Curox Jet™

Catalog Number: CFJ5-250,CFJ1-270

Compatible Connector: Needleless Connectors

Condition: I.V. Related

Factory ISO Certification: No ISO Certification information available

Latex: No

Package Contents: Strips,Individuals

Product Type: Disinfecting Cap

Shelf Life: 3 Year

eClass 14 Classification Group: 34221209

3M™ Ranger™ Irrigation Fluid Warming Unit, 24700, 120V-ENG-B, 1 Each

3M ID 7100236198 UPC 00707387803148

Details

Quickly adapts to changes in flow rates: 0 to 865 mL per minute
Dry heat system monitors plate temperature four times per second, adjusting to maintain a 41°C set point
Audible/visible, over/under temperature alarm indicators
Easy-to-use cleaning tool

Typical properties

Brands: Ranger™
Clinical Area: OR
Device Rating: 100-120 VAC / 220-240 VAC
Factory ISO Certification: No ISO Certification information available
Fluid Type: Irrigation Fluid
Low Temperature Alarm: Under-temperature set point: 33°C
Model: 24700
Primary Alarm: Over-temperature primary set point: 48°C
Product Type: Warming Unit
Quantity: 1 each
Secondary Alarm: Over-temperature secondary set point: 50°C
Set Point Temperature: 41° C
eClass 14 Classification Group: 34540392

Dimensions and Classifications

Overall Height (Imperial): 11.4 in
Overall Width (Imperial): 7.5 in

3M™ Synthetic Cast Stockinet

Details

It is water repellent and therefore suitable for use with Soft Cast as a water proof cast

Suitable for use with all casting materials, plaster and synthetic

Available in a variety of widths to meet your casting needs

Typical properties

Brands: 3M™

Cladimed Code: M50BB02

Factory ISO Certification: No ISO Certification information available

Model: MS01, MS02, MS03, MS04, MS06

Product Type: Cast Stockinet

Product Type Free Format: Casting Accessories

Product Use: Accessory

Therapeutic Area and Conditions: Break, Fracture

Units per Pack: 1

Dimensions and Classifications

Overall Length (Imperial): 25 yd

Overall Length (Metric): 22.86 m

Overall Width (Imperial): 1 in, 2 in, 3 in, 4 in, 6 in

Overall Width (Metric): 2.5 cm, 5 cm, 7.5 cm, 10 cm, 15 cm

3M™ Medical Tape 1529, Single Sided Microporous Rayon Nonwoven Fabric, 83# Liner, CONFIGURABLE

3M ID 7100012624

Details

Acrylic Adhesive
Breathable
Printable
Good Processability

Typical properties

Adhesive Material: Acrylate
Adhesive Type: Acrylic/Acrylate
Backing (Carrier) Material: Rayon Non-woven
Brands: 3M™
Breathable: Yes
Conformability: Medium
Factory ISO Certification: No ISO Certification information available
Fluid Resistance Backing/Carrier: No
Hypoallergenic: No
Latex: No
Liner Caliper (Metric): 150 Micron
Liner Caliper (mils): 6 mil
Liner Color: White
Liner Material: Paper
Liner Weight: 83.0 lb.
Liner Weight (Metric): 135 g/m²
Material: Rayon Non-woven
Maximum Length (Metric): 457 m
Maximum Width Capacity: 48 in
Maximum Width Capacity (Metric): 1220 mm
Printable Backing: Yes
Product Color: White
Product Type: Rayon Non-woven
Product Usage: Adhesion to Skin
Sterilization Method: Ethylene Oxide (EO), Gamma
Tape Color: White
Tape Total Caliper: 5.5 mil
Tape Total Caliper (Metric): 140.0 Micron
Tape Type: Single Sided Rayon Nonwoven Fabric Tape
eClass 14 Classification Group: 34180201

Dimensions and Classifications

Overall Thickness (Imperial): 5 mil
Overall Thickness (Metric): 0.14 mm
Overall Width (Imperial): 48 in
Overall Width (Metric): 121.92 cm

Stethoscope Binaural Assembly

Details

Binaural assembly allows for cost-effective replacement of worn assemblies
3M Service Center provides prompt, accurate and efficient repairs and service
Refurbished stethoscopes carry a two-year warranty, except for the Lightweight
and Select models whi

Typical properties

Binaural Length (Imperial): 21.654 in, 26.772 in, 27 in, 27.165 in, 27.953 in, 28 in, 31.89 in

Binaural Length (Metric): 55 cm, 68 cm, 69 cm, 71 cm, 71.1 cm, 81 cm

Brands: Littmann®

Eartip Type: Soft Sealing

Factory ISO Certification: No ISO Certification information available

Headset Material: Anodized Aluminum

Model: Classic III™, Lightweight II S.E., Master Classic II™

Product Color: Black, Burgundy, Lavender, Light Blue

Product Type: Spare Parts Kit

Tube Color: Black, Burgundy, Caribbean Blue, Ceil Blue, Chocolate, Coral, Dark Olive Green, Gray, Hunter Green, Lavender, Lemon-Lime, Lilac, Navy Blue, Pearl pink, Pink, Plum, Raspberry, Red, Turquoise

Units per Pack: 1

eClass 14 Classification Group: 34340191

Dimensions and Classifications

Overall Length (Imperial): 27 in

Overall Length (Metric): 69 cm, 71 cm

3M™ Steri-Drape™ Laparoscopic Drape 1032NS, Lithotomy Position, 95 IN, aperture size 10 1/2 IN x 11 1/2 IN, 16/CS

3M ID 7000053697 UPC 00707387560157

Details

Absorbent throughout entire drape
Resistant to Strikethrough
Fluid Control Features
Reliable, dependable adhesive

Typical properties

Brands: Steri-Drape™
Factory ISO Certification: No ISO Certification information available
Product Type: Laparoscopy Drape
Product Use: General Surgery

Dimensions and Classifications

Overall Length (Metric): 214 cm
Overall Width (Metric): 228 cm

3M™ Steri-Drape™ Laparotomy/Laparoscopy Drapes 1031

3M ID 7000002775 UPC 30707387381814

Details

Absorbent throughout entire drape
Resistant to Strikethrough
Fluid Control Features
Reliable, dependable adhesive

Typical properties

Application: Supine position
Brands: Steri-Drape™
Cladimed Code: E51AA05
Factory ISO Certification: No ISO Certification information available
Material: Fabric
Model: 1031
Procedure: General Surgery, Obstetrics and Gynaecology, Urology
Product Color: Blue
Product Type: Laparoscopy Drape
Product Type Free Format: Drape
Product Use: General Surgery
Sterile: Yes
Therapeutic Area and Conditions: General Surgery, Obstetrics and Gynaecology, Urology
Units per Pack: 10

Dimensions and Classifications

Overall Length (Imperial): 112 in
Overall Length (Metric): 285 cm
Overall Width (Imperial): 90 in
Overall Width (Metric): 228 cm

3M™ Steri-Drape™ Laparoscopic Pack 1032P, 5 per Carton / 2 Cartons per Case

3M ID 7000030255 UPC 00707387563257

Details

Absorbent throughout entire drape
Fluid Control Features
Superior Strength and Comfort

Typical properties

Additional Drapes: Pack
Application: Lithotomy position
Brands: Steri-Drape™
Cladimed Code: E51AA05
Factory ISO Certification: No ISO Certification information available
Product Type: Laparoscopy Drape
Product Use: Procedure Specific
Units per Pack: 5

Dimensions and Classifications

Overall Length (Metric): 230 cm
Overall Width (Metric): 250 cm

3M™ Steri-Drape™ Laparotomy/Laparoscopy Drapes 9063

3M ID 7000002779 UPC 30707387560455

Details

Absorbent throughout entire drape
Resistant to Strikethrough
Fluid Control Features
Reliable, dependable adhesive

Typical properties

Brands: Steri-Drape™
Factory ISO Certification: No ISO Certification information available
Incise Area Width (Metric): 30 cm
Loophole Length (Metric): 10 cm
Loophole Width (Metric): 30 cm
Material: Fabric
Model: 9063
Procedure: Urology
Product Color: Blue
Product Type: Laparotomy Drape
Product Type Free Format: Drape
Product Use: General Surgery
Sterile: Yes
Therapeutic Area and Conditions: General Surgery, Orthopaedic
Units per Pack: 10

Dimensions and Classifications

Overall Length (Imperial): 100 in
Overall Length (Metric): 254 cm
Overall Width (Imperial): 112 in
Overall Width (Metric): 285 cm

3M™ Steri-Drape™ Laparoscopy Drape 1032

3M ID 7000002774 UPC 30707387381760

Details

Absorbent throughout entire drape
Resistant to Strikethrough
Fluid Control Features
Reliable, dependable adhesive

Typical properties

Application: Lithotomy position
Brands: Steri-Drape™
Cladimed Code: E51AA05
Factory ISO Certification: No ISO Certification information available
Model: 1032
Procedure: General Surgery, Obstetrics and Gynaecology, Urology
Product Type: Laparoscopy Drape
Product Type Free Format: Drape
Product Use: General Surgery
Therapeutic Area and Conditions: General Surgery, Obstetrics and Gynaecology, Urology
Units per Pack: 8

Dimensions and Classifications

Overall Length (Metric): 214 cm
Overall Width (Imperial): 95 in
Overall Width (Metric): 228 cm

**3M™ Steri-Drape™ Urological Drape, 1071, 23 inch x 35 inch (60cm x 90cm),
aperture size 2 inches (5cm), 10/Carton, 4 Cartons/Case**

3M ID 7000002614 UPC 30707387018741

Details

Impervious plastic film provides a barrier to liquids and creates a sterile surface around the surgical site

Matte finish helps reduce glare from the drape surface during the procedure

Features a finger cot for insertion of surgeon's finger, intended to

Typical properties

Accessories: Aperture

Brands: Steri-Drape™

Cladimed Code: E51BH03

Factory ISO Certification: No ISO Certification information available

Loophole Length (Metric): 5 cm

Material: Plastic

Model: 1071

Procedure: Urology

Product Color: Transparent

Product Type: Urology Drape

Product Type Free Format: Drape

Product Use: Urology

Sterile: Yes

Therapeutic Area and Conditions: Urology

Units per Pack: 10

Dimensions and Classifications

Overall Length (Imperial): 23 in

Overall Length (Metric): 60 cm

Overall Width (Imperial): 35 in

Overall Width (Metric): 90 cm

3M™ Steri-Drape™ Basic Set-Up Pack 9020A

3M ID 7000002815 UPC 00707387563592

Details

1 Suture Bag, 1 9036 Mayo Stand Cover, 4 Utility Drapes, 1 Back Table Cover
Resistant to Strikethrough

Typical properties

Brands: Steri-Drape™

Factory ISO Certification: No ISO Certification information available

Model: 9020A

Procedure: General Surgery

Product Type: Surgical Pack

Product Use: General Surgery

3M™ Bair Hugger™ Warming Blanket, 44000

3M ID B00042304

Details

Can be used in supine, prone, lithotomy and other patient positions

Typical properties

Brands: Bair Hugger™

eClass 14 Classification Group: 34540392

3M™ Bair Hugger™ Warming Blanket 58501, Lithotomy Underbody, 10/Case

3M ID 7100212589 UPC 50707387790207

Details

Underbody design warms the patient while providing full, unrestricted patient access

One clear plastic drape (included) helps retain warm air around the head of the patient

Constructed of soft, radiolucent materials

Fluid outlets minimize pooling of fl

Typical properties

Application: Medical

Blanket Type: Underbody

Brands: Bair Hugger™

Cladimed Code: Non applicable

Clinical Area: Cardiac & Specialty, OR, Underbody

Drape Length: 24 in

Drape Length (Metric): 61 cm

Drape Width: 24 in

Drape Width (Metric): 61 cm

Factory ISO Certification: No ISO Certification information available

Product Type: Blanket

Quantity: 10 Case

Total Units per Case: 10 per Case

Units per Pack: 10

eClass 14 Classification Group: 34540392

Dimensions and Classifications

Overall Length (Imperial): 74 in

Overall Length (Metric): 91 cm

Overall Width (Imperial): 36 in

Overall Width (Metric): 188 cm

3M™ Attest™ Super Rapid Steam Biological Indicator, 1492

Details

Results in just 24 minutes
Color-coded (brown cap) for quick reference and ease of use
ISO 11138-1:2017 and ISO 11138-3:2017 compliant
Monitors 270°F/132°C and 275°F/135°C dynamic-air-removal saturated steam sterilization processes
Compatible with the

Typical properties

Biological Indicator System: Super Rapid
Brands: Attest™
Cap Color: Brown
Catalog Number: 1492V,1492VS
Cladimed Code: E52IC01
Factory ISO Certification: No ISO Certification information available
Incubation Period: 24 Minute
Inner Packs per Case: 2 Cartons per Case, 4 Cartons per Case
Product Color: Brown
Product Type: Biological Indicator
Product Use: Load Monitoring
Sterilization Method: Steam
Total Units per Case: 100 per Case, 200 per Case
Units per Inner Pack: 50 per Carton
eClass 14 Classification Group: 34410601

3M™ Littmann® Stethoscope Spare Parts Kit, Classic II Infant Assembly, 40013

3M ID 7100060436 UPC 00707387773007

Details

Quality and reliability in one convenient package
Contains one floating diaphragm for the stethoscope chestpiece
Contains a black rim for assembly of the diaphragm to the chestpiece
Contains a Gray rim for assembly of the diaphragm to the chestpiece

Typical properties

Brands: Littmann®
Cladimed Code: K50BE02
Diaphragm Diameter (Imperial): 1.1 in
Diaphragm Diameter (Metric): 2.7 cm
Factory ISO Certification: No ISO Certification information available
Kit Includes: Black Snap-on Rim, Floating Diaphragm, Grey Snap-on Rim
Model: Infant
Product Color: Black, Gray
Product Type: Spare Parts Kit
Units per Pack: 10
eClass 14 Classification Group: 34340191

3M™ Attest™ Steam Biological Indicator, 1262

Details

Accurate BI results with 48-hour visual color readout
Color-coded (brown cap) for quick reference and easy use
Compliant with ISO 11138-1:2017 and ISO 11138-3:2017 standards
Monitors 250°F/121°C gravity displacement and 270°F/132°C vacuum-assisted
satu

Typical properties

Biological Indicator System: Standard
Brands: Attest™
Cap Color: Brown
Catalog Number: 1262P,1262
Cladimed Code: E52IC01
Factory ISO Certification: No ISO Certification information available
Incubation Period: 48 Hour
Inner Packs per Case: 4 Cartons per Case
Product Color: Brown
Product Type: Biological Indicator
Product Type Free Format: Biological Indicators
Product Use: Load Monitoring
Sterilization Method: Steam
Total Units per Case: 100 per Case, 400 per Case
Units per Inner Pack: 25 per Carton, 100 per Carton
eClass 14 Classification Group: 34410601

3M™ Tegaderm™ Antimicrobial Transparent Dressing 9124

Details

Antimicrobial transparent IV dressing with CHG formulated into the adhesive offers antimicrobial protection without requiring additional moisture to activate. Its integrated design combines antimicrobial protection with site visibility and application ease.

Typical properties

Boxes per Case: 4.0,-12345.0

Brands: Tegaderm™

Catalog Number: 9124,9124NS

Department: Cardiovascular, Dialysis Center, EMERGENCY, Intensive Care Unit, Medical-Surgical, Oncology, Operating Room-Surgery, Radiology, Urgent Care, Wound Care

Dressing Type: Antimicrobial Transparent

Factory ISO Certification: No ISO Certification information available

Hypoallergenic: No

Inner Packs per Case: 4 Cartons per Case

Product Form: Bulk

Sterile: No, Yes

Total Units per Case: 400 per Case, 800 per Case

Units per Case: 800.0,400.0

Units per Inner Pack: 100 per Carton

Units per Pack: 100

eClass 14 Classification Group: 34180202

Dimensions and Classifications

Overall Length (Imperial): 2.75 in

Overall Length (Metric): 7 cm

Overall Width (Imperial): 2.375 in

Overall Width (Metric): 6 cm

SILVERCEL™ Antimicrobial Alginate Dressing

Details

Antimicrobial action
Absorbent

Typical properties

Brands: Silvercel™
Dressing Type: Composite
Factory ISO Certification: No ISO Certification information available
eClass 14 Classification Group: 34210402

Dimensions and Classifications

Overall Length (Imperial): 2 in, 4.25 in, 8 in, 12 in
Overall Length (Metric): 5 cm, 11 cm, 20 cm, 30.5 cm
Overall Width (Imperial): 1 in, 2 in, 4 in, 4.25 in
Overall Width (Metric): 2.5 cm, 5 cm, 10 cm, 11 cm

3M™ Adaptic™ Touch One One-Sided Non-Adhering Silicone Dressing

3M ID B5005265092

Details

Helps protect the wound bed while minimising pain and trauma on removal and at dressing change

The one sided silicone coating can help make application easier by not adhering to clinicians' gloves

Designed to facilitate the free passage of exudate into

Typical properties

Brands: Adaptic™

eClass 14 Classification Group: 34210402

NU-DERM™ Alginate Wound Dressing, AWD404, 10 cm x 10 cm, 10 ea/bx

3M ID 7100238776 UPC 15051978002246

Details

Creates a gel to support a moist wound healing environment
Highly absorbent
Strong when wet
Cuttable

Typical properties

Brands: Nu-Derm™
Factory ISO Certification: No ISO Certification information available
eClass 14 Classification Group: 34210402

Dimensions and Classifications

Overall Length (Imperial): 4 in
Overall Length (Metric): 10 cm
Overall Width (Imperial): 4 in
Overall Width (Metric): 10 cm

SNAP™ Bridge Dressing Kit (Foam), BKTF14X11/10, 14 cm x 11 cm, 10/pk

3M ID 7100237929 UPC 00849554006317

Details

Helps minimize pressure damage and has a built-in bridge and port for one-step application

Soft pad cushioning under the foam bridge to improve patient comfort

Dressing features cut-to-length tubing with integrated one-way check valve

Typical properties

Brands: Snap™

Factory ISO Certification: No ISO Certification information available

eClass 14 Classification Group: 34210701

Dimensions and Classifications

Overall Length (Metric): 11 cm

Overall Width (Metric): 14 cm

3M™ V.A.C.® Granufoam™ Dressing

Details

Multiple shapes and sizes to accommodate diverse wounds
3M™ V.A.C.® Granufoam™ Dressings are available in: four sizes
(Small/Medium/Large/X-Large), 3M™ V.A.C.® Granufoam™ Round Dressing,
3M™ V.A.C.® Granufoam™ Thin Dressing, and 3M™ V.A.C.® Granufoam™ H

Typical properties

Brands: V.A.C.®
Catalog Number: M8275052/10,M8275051/10
Factory ISO Certification: No ISO Certification information available
Product Color: Black
Size: Large, Medium, Small, X-Large
eClass 14 Classification Group: 34210701

Dimensions and Classifications

Overall Length (Metric): 18 cm
Overall Thickness (Imperial): 1.26 in
Overall Thickness (Metric): 3.2 cm
Overall Width (Metric): 12.5 cm

3M™ Snap™ Therapy Cartridge

Details

A mechanically powered negative pressure device that allows patient mobility(1) - no batteries or leads that interfere with daily activities
Discreet device is silent, compact and lightweight to help maintain patient's quality of life(1)
Customizable and

Typical properties

Brands: Snap™
Catalog Number: SNPA100US
Factory ISO Certification: No ISO Certification information available
Pressure Setting: 75 mmHg, 100 mmHg, 125 mmHg
Volume (Metric): 60 mL
eClass 14 Classification Group: 34210701

PREVENA PLUS™ 150 mL Canister, PRE4095, 150 ml, 5/pk

3M ID 7100237237 UPC 00849554005310

Details

Compatible with the 3M™ Prevena™ Plus 125 Therapy Units (7 & 14 day models)

Canister is 15.5 x 9 x 2.5 cm

Canister tubing length is 45 cm

Typical properties

Brands: Prevena™

Factory ISO Certification: No ISO Certification information available

Volume (Imperial): 5.072 fl oz

Volume (Metric): 150 mL

3M™ Attest™ Rapid Steam Biological Indicator, 1292E, Brown Cap, 3 hr, 50/PAC, 4 PAC/CS, 200/CS

3M ID 7000053661 UPC 30707387508556

Details

Accurate results in 3 hours

Color-coded (brown cap) for quick reference and easy use

Compliant with ISO 11138-1:2017 and ISO 11138-3:2017

Monitors 250°F/121°C to 253°F/123°C gravity displacement and 250°F/121°C to 273°F/134°C vacuum-assisted steam ster

Typical properties

Biological Indicator System: Rapid

Brands: Attest™

Cap Color: Brown

Catalog Number: 1292E

Cladimed Code: E52IC01

Factory ISO Certification: No ISO Certification information available

Incubation Period: 3 Hour

Inner Packs per Case: 4 Cartons per Case

Product Type: Biological Indicator

Product Use: Load Monitoring

Sterilization Method: Steam

Total Units per Case: 200 per Case

Units per Inner Pack: 50 per Carton

eClass 14 Classification Group: 34410601

3M™ Attest™ Steam Biological Indicator, 1262-S, Brown Cap, 48 hr, 300/CAR, 2 CAR/CS, 600/CS

3M ID 7000053811 UPC 30707387575169

Details

Accurate results with 48-hour visual color readout
Designed for pharmaceutical and industrial (Life Science) steam sterilization applications
Compliant with ISO 11138-1:2017 and ISO 11138-3:2017 standards
Monitors 250°F/121°C gravity displacement and 2

Typical properties

Biological Indicator System: Standard
Brands: Attest™
Cap Color: Brown
Catalog Number: 1262-S
Factory ISO Certification: No ISO Certification information available
Incubation Period: 48 Hour
Inner Packs per Case: 2 Cartons per Case
Product Type: Biological Indicator
Sterilization Method: Steam
Total Units per Case: 600 per Case
Units per Inner Pack: 300 per Carton
eClass 14 Classification Group: 34410601

ACTISORB™ Silver 220 Dressing

Details

Activated charcoal traps odour in the dressing(1)

Activated charcoal binds bacteria and toxins that impair the healing process(1)

Silver kills the bacteria in the dressing(5)

Typical properties

Brands: Actisorb™

Factory ISO Certification: No ISO Certification information available

HCPCS Code: A4649

eClass 14 Classification Group: 34210402

Dimensions and Classifications

Overall Length (Imperial): 3.75 in, 4.2 in, 7.6 in

Overall Length (Metric): 9 cm, 10.5 cm, 19 cm

Overall Width (Imperial): 2.5 in, 4.2 in

Overall Width (Metric): 6.5 cm, 10.5 cm

3M™ Kerramax Care™ Super-Absorbent Dressing

Details

Super-absorbent dressings for absorbing and retaining high levels of exudate^{1*}
Sequesters and retains bacteria and MMPs^{2*, 3*} away from the wound bed,
preventing the transmission risk of infection
Soft, conformable and foldable⁴
Easy to apply⁴ using eit

Typical properties

Brands: Kerramax Care™
Factory ISO Certification: No ISO Certification information available
Inner Packs per Case: 24 Cartons per Case, 38 Cartons per Case, 70 Cartons
per Case, 110 Cartons per Case
Total Units per Case: 240 per Case, 380 per Case, 700 per Case, 1100 per Case
Units per Inner Pack: 10 per Carton
eClass 14 Classification Group: 34210402

Dimensions and Classifications

Overall Length (Imperial): 2 in, 4 in, 6 in, 9 in, 12 in, 20 in
Overall Length (Metric): 5 cm, 10 cm, 15.5 cm, 22 cm, 23 cm, 30 cm, 50 cm
Overall Width (Imperial): 2 in, 4 in, 5 in, 8 in
Overall Width (Metric): 5 cm, 10 cm, 13.5 cm, 20 cm

3M™ Prevena Restor™ BellaForm™ Dressing

Details

Available in three dressing options with for use to manage incisions and the surrounding soft tissue (21x19 cm, 24x22 cm & 29x27cm) for up to 7 days
Provide expanded coverage area and delivers therapy to the incision and surrounding soft tissue envelope

Typical properties

Brands: Prevena Restor™

Factory ISO Certification: No ISO Certification information available

Dimensions and Classifications

Overall Length (Metric): 19 cm, 22 cm, 27 cm

Overall Width (Metric): 21 cm, 24 cm, 29 cm

3M™ V.A.C.® Granufoam Silver™ Dressing

Details

Effective protection: Based on *in-vitro* microbial testing, provides an effective barrier to bacterial penetration. The protective silver ion reduces aerobic, gram-negative and gram-positive bacteria, and may help reduce infections in wounds
3M™ V.

Typical properties

Brands: V.A.C.®
Factory ISO Certification: No ISO Certification information available
Product Color: Black
Size: Large, Medium, Small
eClass 14 Classification Group: 34210701

SENSAT.R.A.C.™ Pad, M8275057/10, 10/pk

3M ID 7100236671 UPC 00849554002531

Details

3M™ SensaT.R.A.C.™ Technology is featured in the following therapy systems:
3M™ V.A.C.® Uita 4 Therapy System, 3M™ V.A.C.® RX4 Therapy System,
3M™ ActiV.A.C.™ Therapy System, 3M™ V.A.C.® Simplicity Therapy System,
V.A.C. FREEDOM™ Therapy System, 3M™ Preve

Typical properties

Brands: SensaT.R.A.C.™

Factory ISO Certification: No ISO Certification information available

eClass 14 Classification Group: 34210701

3M™ Touchless Care™ Antifungal Spray, 82402

3M ID B5005265201

Details

Creates a translucent coating that enables skin inspection without product removal

Creates a translucent coating that enables skin inspection without product removal

Typical properties

Brands: Touchless Care™

3M™ Tegaderm™ Antimicrobial I.V. Advanced Securement Dressing 9132

Details

Antimicrobial IV securement dressing with 2% CHG formulated into the adhesive offers antimicrobial protection without requiring additional moisture to activate. Integrated design combines antimicrobial protection with site visibility, catheter securement.

Typical properties

Boxes per Case: 4.0,-12345.0
Brands: Tegaderm™
Catalog Number: 9132NS,9132
Dressing Type: Film
Factory ISO Certification: No ISO Certification information available
Inner Packs per Case: 4 Cartons per Case
Latex: No
Product Form: Bulk
Product Type: Antimicrobial Dressing
Sterile: No, Yes
Total Units per Case: 100 per Case, 200 per Case
Units per Case: 200.0,100.0
Units per Inner Pack: 25 per Carton
Units per Pack: 25
eClass 14 Classification Group: 34180202

Dimensions and Classifications

Overall Length (Imperial): 3.375 in
Overall Length (Metric): 8.5 cm
Overall Width (Imperial): 2.75 in
Overall Width (Metric): 7 cm

3M™ Bair Hugger™ Animal Health Overbody Blanket

Details

Single use overbody forced-air warming blanket for animals provide excellent heat transfer

Made with soft, comfortable, lightweight, radiolucent materials

Perforations across the blanket provide uniform convective warming

To provide safe, effective and

Typical properties

Application: Veterinary

Blanket Type: Full Body

Brands: Bair Hugger™

Factory ISO Certification: No ISO Certification information available

Product Type: Blanket

Quantity: 1 each

Total Units per Case: 10 per Case

eClass 14 Classification Group: 34540392

Dimensions and Classifications

Overall Length (Imperial): 35 in, 60 in, 84 in

Overall Length (Metric): 89 cm, 152 cm, 213 cm

Overall Width (Imperial): 24 in, 36 in

Overall Width (Metric): 61 cm, 91 cm

3M™ Medical Tape, 4578, Polyester Spunlace Nonwoven Extended Wear, Configurable

3M ID 7100301144

Details

Extended Wear even when packaged without release liner
Biocompatible for Use on Intact Skin
Conformable
Comfortable during Wear
Able to adhere to LSE surfaces

Typical properties

Backing (Carrier) Material: Polyester Spunlace
Brands: 3M™
Breathable: Yes
Conformability: Medium
Factory ISO Certification: No ISO Certification information available
Liner Material: Paper
Printable Backing: Yes
Product Type: Non-woven Polyester & Polyester Blend Tape
Product Usage: Adhesion to Skin
eClass 14 Classification Group: 34180201

3M™ Medical Hook Fastener 7334, Low Profile, Configurable

3M ID 7100127448

Details

Available with Synthetic Rubber Adhesive or No Adhesive
Easy to open yet high shear strength during use
Low Profile
Intended for disposable/short term uses

Typical properties

Brands: 3M™
Factory ISO Certification: No ISO Certification information available
Product Color: White

3M™ Fibracol™ Plus Collagen Wound Dressing with Alginate

Details

Maintains a physiologically moist microenvironment
Its unique combination of natural biopolymers created by a process that combines the structural support of collagen and the gel forming properties of alginates into a sterile, soft, absorbent, conformabl

Typical properties

Boxes per Case: 6.0
Brands: Fibracol™
Catalog Number: 2984,2983,2982,2981
Factory ISO Certification: No ISO Certification information available
HCPCS Code: A6021, A6022, A6024
Inner Packs per Case: 6 Cartons per Case
Total Units per Case: 72 per Case
Units per Inner Pack: 6 per Carton, 12 per Carton

Dimensions and Classifications

Overall Length (Imperial): 2 in, 4.375 in, 8.75 in, 15.75 in
Overall Length (Metric): 5 cm, 11.1 cm, 22.2 cm, 40 cm
Overall Thickness (Imperial): 0.375 in
Overall Thickness (Metric): 1 cm
Overall Width (Imperial): 0.375 in, 2 in, 4 in
Overall Width (

3M™ Adaptic™ Touch Non-Adhering Silicone Dressing

Details

Enables fluid transfer to a secondary dressing reducing the risk of exudate pooling and maceration^{1 2}

Easy to apply and protects the wound whilst minimising patient pain and trauma on removal and at dressing change²

Suitable for use, under medical super

Typical properties

Brands: Adaptic™

Factory ISO Certification: No ISO Certification information available

eClass 14 Classification Group: 34210402

Dimensions and Classifications

Overall Length (Imperial): 3 in, 4.25 in, 6 in, 12.75 in

Overall Length (Metric): 7.6 cm, 10 cm, 12.7 cm, 15 cm, 20 cm, 32 cm

Overall Width (Imperial): 2 in, 3 in, 5 in, 8 in

Overall Width (Metric): 5 cm, 7.6 cm, 11 cm, 12 cm, 15 cm, 20 cm, 32 cm

3M™ Silvercel™ Non-Adherent Antimicrobial Alginate Dressing

Details

Antimicrobial hydro-alginate dressing helping maintain a moist wound environment
Non-adherent
Antimicrobial action
Absorbent

Typical properties

Brands: Silvercel™
Factory ISO Certification: No ISO Certification information available
HCPCS Code: A6196, A6197, A6199
eClass 14 Classification Group: 34210402

Dimensions and Classifications

Overall Length (Imperial): 2 in, 4.25 in, 8 in, 12 in
Overall Length (Metric): 5 cm, 11 cm, 20 cm, 30.5 cm
Overall Width (Imperial): 1 in, 2 in, 4 in, 4.25 in
Overall Width (Metric): 2.5 cm, 5 cm, 10 cm, 11 cm

3M™ Prevena™ Peel and Place Dressing Kit

Details

Available with three dressing options for linear incisions up to 13cm, 20cm and 35 cm in length

Dressing foam bolster channels negative pressure to the incision area

Skin-friendly interface layer to wicks fluid away from the surface

Stabilization layer

Typical properties

Brands: Prevena™

Factory ISO Certification: No ISO Certification information available

Dimensions and Classifications

Overall Length (Imperial): 5.118 in, 7.874 in, 13.78 in

Overall Length (Metric): 13 cm, 20 cm, 35 cm

Overall Width (Imperial): 0.709 in

Overall Width (Metric): 1.8 cm

SNAP™ Bridge Dressing Kit (Foam) with SecurRing™ Hydrocolloid, BKTF14X11S/10, 14 cm x 11 cm, 10/pk

3M ID 7100237897 UPC 00849554006362

Details

For use with the 3M™ Snap™ Therapy Cartridge, a disposable negative pressure wound therapy system
Flexible and customizable dressings to address difficult anatomical areas
Built-in bridge and port for one-step application
Hydrocolloid skin-friendly sea

Typical properties

Brands: Snap™
Factory ISO Certification: No ISO Certification information available
eClass 14 Classification Group: 34210701

Dimensions and Classifications

Overall Length (Metric): 11 cm
Overall Width (Metric): 14 cm

3M™ V.A.C.® Simplace™ Dressing

3M ID B5005265141

Details

No scissors necessary

Design allows for easier bridging

Includes 3M™ Tegaderm™ Drape

Utilizes 3M™ V.A.C.® Granufoam™ Dressing material redesigned in a spiral-cut foam

Available in two sizes (Small/Medium)

Each kit includes: 2 spiral 3M™ V.A.C.® Granu

Typical properties

Brands: V.A.C.®

Factory ISO Certification: No ISO Certification information available

Size: Medium, Small

eClass 14 Classification Group: 34210701

3M™ Attest™ VH₂O₂ Tri-Metric Chemical Indicators

Details

Detects failed VH₂O₂ sterilization cycles more accurately than any other CI tested*
*Competitive Type 1 and Type 4 VH₂O₂ CIs
Monitors 3 critical variables – exposure time, temperature and VH₂O₂ co

Typical properties

Brands: Attest™
Catalog Number: 1348,1348E
Cladimed Code: Non applicable
Factory ISO Certification: No ISO Certification information available
Inner Packs per Case: 4 Bags per Case
Product Type: Chemical Indicator
Product Use: Pack Monitoring
Sterilization Method: Hydrogen Peroxide
Total Units per Case: 1000 per Case
Units per Inner Pack: 250 per Bag
eClass 14 Classification Group: 34410401

Dimensions and Classifications

Overall Length (Imperial): 2 in, 4 in
Overall Length (Metric): 5.1 cm, 10.2 cm
Overall Width (Imperial): 0.75 in
Overall Width (Metric): 1.9 cm

3M™ Snap™ Therapy Strap

3M ID B5005265165

Details

Wear the device discreetly under clothes
For use with the 3M™ Snap™ Therapy Cartridge

Typical properties

Brands: Snap™
Factory ISO Certification: No ISO Certification information available
Product Color: Black
Size: Large, Medium, Small
eClass 14 Classification Group: 34210701

Dimensions and Classifications

Overall Length (Imperial): 18 in, 21 in, 24 in
Overall Length (Metric): 46 cm, 53 cm, 61 cm

3M™ Prevena™ 45 mL Canister

3M ID B5005265179

Details

Compatible with the 3M™ Prevena™ 125 Therapy Unit
Canister is 7.2 x 6.9 x 3 cm
Canister tubing length is 20.2 cm

Typical properties

Brands: Prevena™
Factory ISO Certification: No ISO Certification information available
Volume (Imperial): 1.522 fl oz
Volume (Metric): 45 mL

Prevena Restor™ Axio-Form™ Incision Management System, PRE5501, 29 cm x 28 cm

3M ID 7100247302

Details

Available for use to manage incisions and the surrounding soft tissue (29x28 cm)
for up to 7 days

Provides pre-set, continuous NPWT at -125mmHg up to 14 days with a
replaceable 150 mL canister (single use, sterile, disposable)

Disposable, single patient

Typical properties

Brands: Prevena Restor™

Factory ISO Certification: No ISO Certification information available

Product Type: 14-day Pump

Dimensions and Classifications

Overall Length (Metric): 28 cm

Overall Width (Metric): 29 cm

3M™ Kerralite Cool™ Moisture Balancing Hydrogel Dressing

Details

Hydrogel moisture balancing dressing with Pro-inoic™ technology
Polyurethane outer film is water resistant¹ and highly breathable protecting the wound from bacteria and the external environment whilst being permable to moisture
Non-adherent which may he

Typical properties

Brands: Kerralite Cool™
Factory ISO Certification: No ISO Certification information available
eClass 14 Classification Group: 34210402

Prevena Restor™ Axio-Form™ Dressing Kits, PRE5555, 29 cm x 28 cm, 5 Pk

3M ID 7100246810 UPC 00849554007949

Details

Available for use to manage incisions and the surrounding soft tissue (29x28 cm) for up to 7 days

Provide expanded coverage area and delivers therapy to the incision and surrounding soft tissue envelope while bolstering and stabilizing the area
Precisio

Typical properties

Brands: Prevena Restor™

Factory ISO Certification: No ISO Certification information available

Dimensions and Classifications

Overall Length (Metric): 28 cm

Overall Width (Metric): 29 cm

3M™ V.A.C.® Drape

3M ID B5005265136

Details

Drape designed exclusively for use with 3M™ V.A.C.® Therapy
Helps provide a moist wound healing environment
Barrier to outside contaminants

Typical properties

Brands: V.A.C.®
Factory ISO Certification: No ISO Certification information available
eClass 14 Classification Group: 34210701

3M™ V.A.C.® Y-Connector

3M ID B5005265172

Details

Connects two dressings to a single 3M™ V.A.C.® Therapy Unit
Available in a case of 5
Available in a case of 10

Typical properties

Brands: V.A.C.®
Factory ISO Certification: No ISO Certification information available
eClass 14 Classification Group: 34210701

FUTURO™ Slim Silhouette Ankle Support 95347EN, Small/Medium

3M ID 70011001164 UPC 00051131201705

Details

Moderate-support design offers customizable levels of compression and support
Helps support symptoms associated with sprains, ankle instability and overuse
Contoured to fit the natural curves of a woman's foot and ankle
Breathable materials allow air t

Typical properties

Body Part: Ankle
Brands: FUTURO™
Condition: Arthritis, Pinched Nerve, Plantar Fasciitis, Sprains, Strains
Factory ISO Certification: No ISO Certification information available
Fit Range: 7.5" to 8.5"
Product Color: Gray
Product Type: Support
Product Use: Arch/Heel Pain, Exercise, Foot, Arch & Heel Pain, General Support, General Support for Athletic Activity, Hiking, Moderate/Occasional Pain, Recovery, Running, Walking
Size: Small/Medium
Sizes Available: One Size – Adjustable
Support Level: Moderate
Support and Compression Level: Moderate
Type: Support
Where to Measure: Measure around ankle.
eClass 14 Classification Group: 34200201

FUTURO™ Comfort Elbow with Pressure Pads

3M ID CBGBLW011028 UPC 00051131200555

Details

Stretchy design conforms to your elbow for comfort and moderate support
Breathable fabric for cooling comfort
Adjustable strap for customizable compression
Flexible materials promote a full range of motion
Wear on either arm for versatility
Low profile

Typical properties

Body Part: Elbow, Elbow/Forearm
Brands: FUTURO™
Catalog Number: 47863ENR
Condition: Arthritis, Golfer's Elbow, Pinched Nerve, Repetitive Stress Injury, Sprains, Strains, Swelling, Tendonitis, Tennis Elbow
Factory ISO Certification: No ISO Certification information available
Fit Range: SMALL fits: 9" to 10"
MEDIUM fits: 10" to 11"
LARGE fits: 11" to 12"
Material: Nylon, Polyester, Silicone, Spandex
Package Contents: 1/pack
Product Color: Gray
Product Type: Support
Product Use: During Strong Activity, General Support, General Support for Athletic Activity, Moderate/Occasional Pain, Post Cast, Prevention, Recovery, Tennis Elbow
Size: Large, Medium, Small
Sizes Available: Small,Medium,Large
Support Level: Moderate
Support and Compression Level: Moderate
Type: Support
Where to Measure: Measure around elbow.
eClass 14 Classification Group: 34200201

FUTURO™ Performance Comfort Wrist Support

3M ID CBGBLW011041 UPC 00051131200616

Details

Moderate-support design offers customizable levels of compression and support
Easy-to-use design for personalized adjustment
Breathable materials allow air to circulate and help keep skin dry
Wear on either wrist for versatility
Supported by our exper

Typical properties

Body Part: Wrist
Brands: FUTURO™
Condition: Arthritis, Carpal Tunnel Syndrome, Pinched Nerve, Repetitive Stress Injury, Sprains, Strains, Swelling, Tendonitis, Thumb Hyperextension
Factory ISO Certification: No ISO Certification information available
Fit Range: 4.5" to 9.5"
Material: Nylon, Polyester, Polyurethane, Spandex
Product Color: Black
Product Type: Wrap around
Product Use: Aching, Weak or Swollen Hand or Wrist, During Strong Activity, General Support for Athletic Activity, Moderate/Occasional Pain, Prevention, Recovery
Size: Adjustable
Sizes Available: One Size - Adjustable
Support Level: Moderate
Support and Compression Level: Moderate
Type: Wrap around
Where to Measure: Measure around wrist.
eClass 14 Classification Group: 34200201

FUTURO™ Knee Strap, 09189EN, Adjustable

3M ID 70007013058 UPC 00051131200685

Details

Center pad applies moderate pressure on your injured tendon to help relieve symptoms of patella tendonitis

Outside pads help improve patellar tracking

Adjustable hook-and-loop design for custom comfort

Breathable material releases excess heat for cooli

Typical properties

Body Part: Knee

Brands: FUTURO™

Condition: Arthritis, Jumper's Knee, Patella Tracking, Pinched Nerve, Runner's Knee, Sprains, Strains, Swelling, Tendonitis

Factory ISO Certification: No ISO Certification information available

Fit Range: 12.5" to 17.5"

Material: Acetal Plastic (POM), Nylon, Polyester, Polyethylene, Polypropylene, Polyurethane, Spandex, Thermoplastic Elastomer (TPE)

Product Color: Black

Product Type: Wrap around

Product Use: During Strong Activity, General Support for Athletic Activity, Jumpers Knee, Medial/Lateral Support, Moderate/Occasional Pain, Prevention, Recovery

Size: Adjustable

Sizes Available: One Size - Adjustable

Support Level: Moderate

Support and Compression Level: Moderate

Type: Wrap around

Where to Measure: Measure around leg below kneecap.

eClass 14 Classification Group: 34200201

Nexcare™ Absolute Waterproof Tape

3M ID COBBLW014001 UPC 00051135811153

Details

From the #1 leader in U.S. hospital tapes
Strong adhesive stays on during water activities and exercising
Provides cushioned protection to help prevent blisters
Secures gauze and dressings
Conforms comfortably to fingers, wrists, and elbows
Flexes an

Typical properties

Brands: Nexcare™
Factory ISO Certification: No ISO Certification information available
Material: Foam, Plastic
Product Color: Tan
Product Type: Tape, Waterproof

Dimensions and Classifications

Overall Length (Imperial): 180 in
Overall Length (Metric): 4.5 m, 4.57 m
Overall Width (Imperial): 1 in, 1.5 in
Overall Width (Metric): 25.4 mm, 38.1 mm

Nexcare™ Tegaderm™ Transparent Dressing

3M ID COBBLW014045 UPC 00051131641143

Details

The #1 hospital brand
Provides protection to minor burns, scrapes, cuts, blisters and abrasions
Stays on skin for long periods of time with minimal skin irritation
Stays on during water activities, showering and bathing
Easy-to-apply and remove
Virtu

Typical properties

Application: Caregivers, Hard-to-Cover Areas, Post-Surgical / Sutures / Stitches, Sensitive Skin, Waterproof
Brands: Nexcare™
Factory ISO Certification: No ISO Certification information available
Hospital Name: Tegaderm
Material: Plastic
Package Contents: 4 Pack, 10 Pack, 8 Pack
Product Color: Transparent
Product Type: Clear Dressing, Film
Properties: Breathable, Non-Stick Pad, Waterproof
Size: Assorted
Sizes Available: 4 ct. (Cat# H1626): 4 in x 4 3/4 in, 8 ct. (Cat# H1624): 2 3/8 in x 2 3/4 in, 10 ct. assorted (Cat# TEGA-10): 1 3/4 in x 1 3/4 in, 2 3/8 in. x 2 3/4 in.
Solution for: Waterproof
Waterproof: Yes
Wound Type: Blisters, Cuts / Scrapes / Abrasions, Minor Burns
eClass 14 Classification Group: 34400201

Dimensions and Classifications

Overall Length (Imperial): 2.75 in, 4.75 in
Overall Length (Metric): 7 cm, 12 cm
Overall Width (Imperial): 2.375 in, 4 in
Overall Width (Metric): 6 cm, 10 cm

ACE™ Brand Reversible Splint Wrist Brace

3M ID COBBLW014105 UPC 00051131200166

Details

Provides moderate support to sore, weak and injured wrists
Breathable, lightweight materials for comfortable all-day support
Ergonomic design lets your fingers move naturally
Three-strap, hook-and-loop design for adjustable fit and custom comfort
Palm

Typical properties

Body Part: Wrist
Brands: ACE™
Closure Method: Hook & Loop
Condition: Arthritis, Carpal Tunnel Syndrome, Sprains, Strains, Tendonitis
Factory ISO Certification: No ISO Certification information available
Fit Range: 5.5" to 8.5"
Latex-free: Yes
Material: Nylon, Polyester, Spandex
Performance Zone Category: Injury Care
Product Color: Black, Gray
Product Type: Brace
Product Use: General Soreness, Sprains & Strains, Support for Arthritic Joints, Symptoms of Carpal Tunnel Syndrome, Tendonitis
Properties: Adjustable, Breathable, Non Latex Containing
Size: Adjustable
Sizes Available: One Size - Adjustable
Support Level: Moderate
Support Level Description: Provides moderate support and stabilization to help prevent re-injury and relieve symptoms associated with strains, sprains, arthritis and repetitive stress injuries.
Type: Brace
Where to Measure: Measure around wrist at smallest point.
eClass 14 Classification Group: 34200201

ACE™ Brand Compression Elbow Support

3M ID COBBLW014177 UPC 00051131203952

Details

Provides immediate compression for sore elbow
Flexible design allows a full range of motion
Contoured design for optimal fit
Seamless design feels smooth against your skin
Convenient design can be worn on either elbow
Ideal for stiff, weak and injure

Typical properties

Body Part: Elbow
Brands: ACE™
Factory ISO Certification: No ISO Certification information available
Fit Range: SMALL fits: 9" to 10"
MEDIUM fits: 10" to 11"
LARGE fits: 11" to 12"
Latex-free: Yes
Package Contents: 1/pack
Performance Zone Category: Injury Care
Product Color: Gray, White
Product Type: Support
Properties: Breathable, Non Latex Containing, Odor Control, Reusable, Washable
Size: Large, Medium, Small
Sizes Available: Small,Medium,Large
Support Level: Mild
Type: Support
Where to Measure: Measure around forearm below elbow.
eClass 14 Classification Group: 34200201

ACE™ Brand Sports Tape

3M ID COBBLW014204 UPC 00051131200289

Details

Tough design offers firm support
Provides protection to weak and injured joints
Strong adhesive stays put
Easy-to-use tape tears easily
Tape for a secure hold
Ideal for ankles, fingers and wrists
Works great with ACE Sports Underwrap
Size: 1.5" x 1

Typical properties

Brands: ACE™
Factory ISO Certification: No ISO Certification information available
Product Color: Black, Blue
Product Type: Tapes/Underwrap

Dimensions and Classifications

Overall Width (Imperial): 1.5 in

Nexcare™ Strong Hold Pain-Free Removal Adhesive Pad SSD34, 3 in x 4 in (76,2 mm x 101 mm)

3M ID 70007030201 UPC 00051131211964

Details

- Pain-free removal for comfort
- Ideal for sensitive skin
- Removes gently from hair
- Long-lasting adhesion
- For wounds requiring multiple dressing changes
- Repositionable for optimal placement
- Great for use on kids, the elderly and folks with hairy skin

B

Typical properties

- Application: Sensitive Skin
- Brands: Nexcare™
- Factory ISO Certification: No ISO Certification information available
- Material: Plastic
- Package Contents: 4 Pack
- Product Color: Blue
- Product Type: Adhesive Pad
- Properties: Repositionable
- Solution for: Pain-Free Removal, Sensitive Skin
- Waterproof: No
- eClass 14 Classification Group: 34400201

Dimensions and Classifications

- Overall Length (Imperial): 4 in
- Overall Length (Metric): 101 mm
- Overall Width (Imperial): 3 in
- Overall Width (Metric): 76.2 mm

ACE™ Brand Sport Deluxe Back Stabilizer, Adjustable

3M ID CBGBLRUS1499 UPC 00051131205468

Details

Helps alleviate pain and discomfort
Dual strap system stabilizes lower back and supports abdominal muscles
Metal stays for additional support
ACE is America's most trusted brand of braces, supports and elastic bandages.
Based on 2015 TNS Brand Health t

Typical properties

Body Part: Back
Brands: ACE™
Condition: Back Pain
Factory ISO Certification: No ISO Certification information available
Fit Range: Up to 48" waist
Latex-free: No
Material: Cotton, Neoprene, Nylon, Polyester, Polypropylene, Rubber, Spandex
Product Color: Black, Gray
Product Type: Support
Product Use: Back Pain, General Soreness, Support for a saggy abdomen
Size: Adjustable
Sizes Available: One Size - Adjustable
Support Level: Firm, Moderate
Type: Support
Where to Measure: Measure around waist.
eClass 14 Classification Group: 34200201

Nexcare™ Gentle Removal Eye Patch - Small KRJ-14, 1.96 in x 2.36 in (50 mm x 60 mm)

3M ID UU010125241 UPC 00051131216815

Details

KID FRIENDLY: Sized for infants and children, featuring gentle hypoallergenic adhesive that is ideal for sensitive skin

REPOSITIONABLE ADHESIVE EYEPATCH: Proprietary silicone adhesive technology allows easy repositioning with gentle removal and a secure

Typical properties

Age Group: Children

Brands: Nexcare™

Factory ISO Certification: No ISO Certification information available

Package Contents: 14 Pack

Package Quantity: 14

Patches per Box: 14

Product Color: White

Product Type: Eye Patch

Properties: Breathable, Repositionable

Solution for: Pain-Free / Gentle Removal

eClass 14 Classification Group: 34180405

Dimensions and Classifications

Overall Length (Imperial): 2.36 in

Overall Width (Imperial): 1.96 in

3M™ Scotchcast™ Quick Step Splint

Details

Felt on both sides of the splint - helps eliminate the risk of wrong-side application while providing padding and protection for the patient's injury
Water-repellant technology sheds water off the splint, helping keep the patient's skin dry and reduces t

Typical properties

Brands: Scotchcast™
Factory ISO Certification: No ISO Certification information available
Form: Pre-cut
Padding: Double Sided Padded
Product Use: Splinting
eClass 14 Classification Group: 34200204

Dimensions and Classifications

Overall Length (Imperial): 10 in, 12 in, 15 in, 30 in, 35 in
Overall Length (Metric): 25.4 cm, 30.4 cm, 38.1 cm, 76.2 cm, 88.9 cm
Overall Width (Imperial): 2 in, 3 in, 4 in, 5 in
Overall Width (Metric): 5.1 cm, 7.5 cm, 7.6 cm, 10.1 cm, 12.7 cm

3M™ V.A.C.® Peel and Place Dressing Kit

Details

The first 3M™ V.A.C.® Therapy Dressing that can be worn for up to seven days(1)*, which means you can provide consistent and effective NPWT to your patients with fewer dressing changes, clinic visits and home visits. *Information contained within conducte

Typical properties

Brands: V.A.C.®

Catalog Number:

EZ5SMLV001,EZ5MEDV002,EZ5SMLV002,EZ5MEDV001,EZ5LRGV001,EZ5LRGV002

Size: Large, Medium, Small

Units per Pack: 5

FUTURO™ Abdominal Compression Support

3M ID CBGBLW011012 UPC 00051131200944

Details

Moderate-support design offers customizable levels of compression and support
Hook-and-loop fasteners provide a personalized fit
Lifts and trims your abdomen for comfortable support
Helps Provide support to abdomens afflicted by symptoms associated wit

Typical properties

Body Part: Abdomen
Brands: FUTURO™
Condition: Back Pain
Factory ISO Certification: No ISO Certification information available
Fit Range: MEDIUM fits: 32" to 42"
LARGE fits: 42" to 52"
Material: Cotton, Nylon, Polyester, Polyurethane, Spandex
Product Color: White
Product Type: Support
Product Use: During Strong Activity, General Support, Moderate/Occasional Pain, Post Surgery, Prevention, Recovery, Severe/Chronic back pain, Support for a saggy abdomen
Size: Large, Medium
Sizes Available: Medium, Large
Support Level: Moderate
Support and Compression Level: Moderate
Type: Wrap around
Where to Measure: Measure around hips just below waistline and over fullest part of abdomen.
eClass 14 Classification Group: 34200201

FUTURO™ Deluxe Wrist Stabilizer

3M ID CBGBLW011037 UPC 00051131200906

Details

Provides firm support to injured wrists
Helps provide relief from symptoms associated with Carpal Tunnel Syndrome and other wrist injuries
Dorsal stabilizers enhance support
Adjustable straps for custom comfort
Allows your fingers to move freely
Foam

Typical properties

Body Part: Wrist
Brands: FUTURO™
Condition: Arthritis, Carpal Tunnel Syndrome, Pinched Nerve, Repetitive Stress Injury, Sprains, Strains, Swelling, Tendonitis, Thumb Hyperextension
Factory ISO Certification: No ISO Certification information available
Fit Range: S/M fits: 5.5" to 7.5"
L/XL fits: 7.5" to 9"
One Size-Adj. Fits: 6" to 8"
Material: Aluminum, Nylon, Polyester, Polypropylene, Polyurethane, Spandex
Product Color: Gray
Product Type: Brace, Wrist Splint
Product Use: During Strong Activity, General Support for Athletic Activity, Moderate/Occasional Pain, Post Cast, Prevention, Recovery, Sore, Weak or Injured Wrist, Sprains, Symptoms of Carpal Tunnel Syndrome, Tendonitis
Size: Adjustable, Large/X-Large, Small/Medium
Sizes Available: One Size - Adjustable, Large / X-Large, LH, Large / X-Large, Small/Medium, RH, Large / X-Large, RH, Small / Medium, LH
Support Level: Firm, Firm-Stabilizing
Support Level Description: Provides a higher level of support using a combination of power stretch and non-stretch materials and may include shock absorbing materials to help relieve symptoms associated with strains, sprains, arthritis, repetitive stress injuries and to help prevent re-injury.
Support and Compression Level: Firm, Firm-Stabilizing
Type: Brace, Stabilizer
Where to Measure: Measure around the wrist at smallest point.
eClass 14 Classification Group: 34200201

Nexcare™ No Sting Liquid Bandage, .61 Fl oz

3M ID COBBLW014024 UPC 00051131225398

Details

No-sting formula

Waterproof

Ideal for larger scrapes and abrasions that are difficult to cover with traditional bandages

Unique skin shield that covers minor cuts and scrapes and doesn't sting when applied

Provides breathable, waterproof protection th

Typical properties

Application: Waterproof

Brands: Nexcare™

Factory ISO Certification: No ISO Certification information available

Package Contents: 1 Pack

Product Color: Transparent

Product Type: Liquid Bandage

Properties: Non-Stick Pad

Sizes Available: .61 fl. oz. bottle

Solution for: Kids, Sensitive Skin, Waterproof

Spray: Yes

Waterproof: Yes

Wound Type: Cuts / Scrapes / Abrasions

eClass 14 Classification Group: 34180307

Nexcare™ Ultra Stretch Bandages

3M ID COBBLW014039 UPC 00051131995260

Details

The bandage material features a 4-way stretch to move with you
Covers and protects cuts, scrapes and blisters
Diamond shape provides a better seal around the pad
Breathable design
Available In: 30 ct. Assorted and 8 ct. Knee & Elbow
Not made from nat

Typical properties

Brands: Nexcare™
Factory ISO Certification: No ISO Certification information available
Material: Fabric
Package Contents: 30 Pack,8 Pack
Product Color: Tan
Product Type: Bandage
Properties: Breathable
Size: Assorted
Sizes Available: 30 ct. Asst: 8 at 1.15" x 3" (29mm x 76mm), 14 at .9" x 2.25" (22mm x 57mm), 8 at .96" x 1.15" (24mm x 29mm); Knee & Elbow: 2" x 4" (50mm x 101mm)
Solution for: For places that bend, Knees/Elbows
Waterproof: No
Wound Type: Cuts / Scrapes / Abrasions
eClass 14 Classification Group: 34400201

Dimensions and Classifications

Overall Length (Imperial): 4 in
Overall Length (Metric): 101 mm
Overall Width (Imperial): 2 in
Overall Width (Metric): 50 mm

ACE™ Brand Self-Adhering Bandage

3M ID COBBLW014088 UPC 00051131203709

Details

Self-adhering design means no clips are needed
Provides moderate support to weak, sore muscles and joints
Comfortable design is intended for prolonged wear
Easy-to-use design is hassle-free
Fits discreetly under clothing
Wrap design conforms to multi

Typical properties

Application: Securing Hot/Cold, Support/Compression
Body Part: Multi-Purpose
Brands: ACE™
Closure Method: Self-adhering
Factory ISO Certification: No ISO Certification information available
Ideal For: Baseball, Basketball, Cross training, Football, Golf, Hockey, Soccer, Tennis, Volleyball
Injury: Recovery, Sprains & Strains, Swelling
Latex-free: Yes
Performance Zone Category: Injury Care
Product Color: Beige, Tan
Product Type: Bandage
Properties: Breathable, Non Latex Containing, Reusable
Sizes Available: 2" width,3" width: Ideal for ankle, elbow and knee,3" width,4" width
Sport: Baseball, Basketball, Golf, Hockey, Soccer, Tennis, Volleyball
Support Level: Moderate
Support Level Description: Provides adjustable levels of compression, support and therapeutic heat retention to help relieve symptoms associated with strains, sprains, arthritis and muscle pain.
Type: Bandage
eClass 14 Classification Group: 34200190

Dimensions and Classifications

Overall Width (Imperial): 2 in, 3 in, 4 in

ACE™ Brand Sports Underwrap

3M ID COBBLW014157 UPC 00051131222618

Details

Barely-there, breathable design creates a comfortable barrier between your skin and sports tape
Easy-to-use design sticks to itself for hassle-free application
Ideal for elbows, wrists, ankles and knees
Removes residue-free
Great for use with ACE™ Spo

Typical properties

Brands: ACE™
Factory ISO Certification: No ISO Certification information available
Product Color: Black, Tan
Product Type: Tapes/Underwrap

ACE™ Brand Work Belt

3M ID COBBLW014172 UPC 00051131204232

Details

Stabilizing design offers a customizable level of support in the workplace
Adjustable and removable suspenders provide a personalized, comfortable fit
Grip tape strapping prevents slippage
Breathable materials enhance airflow to help keep skin dry
Fou

Typical properties

Body Part: Back
Brands: ACE™
Factory ISO Certification: No ISO Certification information available
Fit Range: Up to 48" waist
Latex-free: No
Material: Nylon, Polyester, Polypropylene, Rubber, Spandex
Performance Zone Category: Return to Activity
Product Color: Black
Product Type: Support
Product Use: Back Pain, General Soreness, Support for a saggy abdomen
Properties: Adjustable, Breathable, Reusable
Size: Adjustable
Sizes Available: One Size - Adjustable
Support Level: Moderate
Type: Support
Where to Measure: Measure around waist.
eClass 14 Classification Group: 34200201

ACE™ Brand Deluxe Thumb Stabilizer, Adjustable, Black, 1/Pack

3M ID CBGBLWUS1367 UPC 00051131216419

Details

Stabilizes and supports sore, weak or injured thumb
Two reinforced stabilizers help support the thumb
Low profile design and materials allow for free movement of remaining fingers
Easy lacing system for one step application and adjustability
Easy on,

Typical properties

Body Part: Thumb
Brands: ACE™
Factory ISO Certification: No ISO Certification information available
Fit Range: 5.5" to 7"
Latex-free: Yes
Material: Acetal Plastic (POM), Nylon, PVC, Polyester, Polyurethane, Rayon, Spandex, Steel
Performance Zone Category: Injury Care
Product Color: Black
Product Type: Support
Properties: Breathable, Non Latex Containing, Washable
Size: Adjustable
Sizes Available: One Size - Adjustable
Support Level: Moderate
Type: Support
Where to Measure: Measure around wrist at smallest point.
eClass 14 Classification Group: 34200201

3M™ Coban™ NL Non-Latex Self-Adherent Wrap with Hand Tear 208X Series

Details

Self-adherent elastic wrap provides a reliable hold, maintains mild compression* and can be used for strain and sprain support and secure dressing or devices without the need to for adhesives, pins, clips, or tape. *May use as a component in a compression

Typical properties

Brands: Coban™
Catalog Number:
2086S,2082O,2084P,2082N,2084O,2084K,2082S,2084S,2082P,2083-1X,2086K,2082G,2082C,2082B,2084B,2081,2083P,2083O,2081T,2086,99001,2083S,2084,2081P,2083,2081O,2082,2082-1X,20815B,2086-1X,2084-1X,2081B
Cladimed Code: M50AB03
Clinical Area: Cardiovascular, Critical Care, Dialysis Centre, Emergency Room, Intensive Care, Surgery, Wound Care
Closure Method: Self-adhering
Condition: Dressing & Device Securement, I.V. Related, Skin Care, Wound Care
Creative Color: Blue
Department: Cardiovascular, Critical Care, Dialysis Center, EMERGENCY, I.V. Therapy, Intensive Care Unit, Medical-Surgical, Operating Room-Surgery, Pediatrics, Urgent Care, Wound Care
Dressing and Device Securement Condition Type: Adhesive Trauma, Skin Injuries-Maceration, Surgical Wound, Tube & Device Securement-Lightweight Tubes & Devices
Factory ISO Certification: No ISO Certification information available
Hypoallergenic: Yes
IV Related Condition Type: CVC PICC, PIV
Inner Packs per Case: 6 Cartons per Case, 18 Cartons per Case, 24 Cartons per Case
Latex: No
Latex-free: Yes
Material: Elastic
Product Color: Assorted, Black, Blue, Green, Orange, Pink, Tan
Product Type: Self-Adherent Wrap, Self-Adherent Wraps
Properties: Non Latex Containing
Sterile: No, Yes
Total Units per Case: 12 per Case, 18 per Case, 24 per Case, 30 per Case, 36 per Case, 48 per Case, 72 per Case
Units per Inner Pack: 2 per Carton, 4 per Carton, 5 per Carton
Units per Pack: 12 , 18 , 24 , 36
eClass 14 Classification Group: 34200190

Dimensions and Classifications

Overall Length (Imperial): 2 yd, 5 yd
Overall Length (Metric): 1.5 m, 4.5 m

Overall Width (Imperial): 1 in, 1.5 in, 2 in, 3 in, 4 in, 6 in
Overall Width (Metric): 2.5 cm, 3.7 cm, 5 cm, 7.5 cm, 10 cm, 15 cm

FUTURO™ Performance Comfort Ankle Support, 01037ENR, Adjustable

3M ID 70007013827 UPC 00051131200623

Details

Moderate-support design offers customizable levels of compression and support
Wraparound design for personalized adjustment
Breathable materials allow air to circulate and help keep skin dry
Heel strap enhances comfort
Wear on either ankle for versati

Typical properties

Body Part: Ankle
Brands: FUTURO™
Condition: Arthritis, Pinched Nerve, Plantar Fasciitis, Sprains, Strains, Swelling, Tendonitis
Factory ISO Certification: No ISO Certification information available
Fit Range: 7.5" to 11"
Material: Nylon, Polyester, Polyurethane, Spandex
Product Color: Black
Product Type: Wrap around
Product Use: Arch/Heel Pain, Foot, Arch & Heel Pain, General Support for Athletic Activity, Moderate/Occasional Pain, Recovery
Size: Adjustable
Sizes Available: One Size - Adjustable
Support Level: Moderate
Support and Compression Level: Moderate
Type: Wrap around
Where to Measure: Measure around ankle.
eClass 14 Classification Group: 34200201

FUTURO™ Comfort Elbow Support

3M ID CBGBLW011027 UPC 00051131200975

Details

4-way stretch materials and design conforms to your elbow for comfort and mild support

Breathable for cooling comfort

Easy-to-use sleeve design

Flexible fabric promotes a full range of motion

Wear on either arm for versatility

Low profile silhouette

Typical properties

Body Part: Elbow, Elbow/Forearm

Brands: FUTURO™

Condition: Arthritis, General Soreness, Golfer's Elbow, Sprains, Strains, Swelling, Tendonitis, Tennis Elbow

Factory ISO Certification: No ISO Certification information available

Fit Range: SMALL fits: 9" to 10"
MEDIUM fits: 10" to 11"
LARGE fits: 11" to 12"

Product Color: Gray

Product Type: Sleeve, Support

Product Use: General Support, Low Impact Activity

Size: Large, Medium, Small

Sizes Available: Small,Medium,Large

Support Level: Mild

Support and Compression Level: Mild

Type: Support

Where to Measure: Measure around elbow.

eClass 14 Classification Group: 34200201

FUTURO™ Night Wrist Support

3M ID CBGBLW011040 UPC 00051131201606

Details

Provides moderate support to injured wrists
Helps provide relief from symptoms associated with Carpal Tunnel Syndrome
Plush, cushioning helps protect your wrist during sleep
Cushioning beads help promote a neutral hand position during sleep
Removable

Typical properties

Body Part: Wrist
Brands: FUTURO™
Condition: Arthritis, Carpal Tunnel Syndrome, Pinched Nerve, Repetitive Stress Injury, Sprains, Strains, Swelling, Tendonitis, Thumb Hyperextension
Factory ISO Certification: No ISO Certification information available
Fit Range: 5.25" to 9"
Material: Aluminum, Nylon, Polyester, Polystyrene, Polyurethane Foam, Spandex
Product Color: Blue
Product Type: Support
Product Use: During Strong Activity, General Support for Athletic Activity, Moderate/Occasional Pain, Post Cast, Prevention, Recovery, Symptoms of Carpal Tunnel while sleeping
Size: Adjustable
Sizes Available: One Size - Adjustable
Support Level: Moderate
Support and Compression Level: Moderate
Type: Support
Where to Measure: Measure around wrist at smallest point.
eClass 14 Classification Group: 34200201

FUTURO™ Performance Knee Stabilizer

3M ID CBGBLW011052 UPC 00051131201569

Details

Provides moderate compression to weak, sore muscles, and injured knees
Side stabilizers reduce lateral motion for comfort
Vented, wraparound style helps keep you cool
Adjustable straps for customizable support
Flexible design promotes a full range of

Typical properties

Body Part: Knee
Brands: FUTURO™
Condition: Arthritis, Jumper's Knee, Patella Tracking, Pinched Nerve, Runner's Knee, Sprains, Strains, Swelling, Tendonitis
Factory ISO Certification: No ISO Certification information available
Fit Range: 13" to 17.5"
Material: Neoprene, Nylon, Polyester, Steel
Product Color: Black
Product Type: Support, Wrap around
Product Use: During Strong Activity, General Support, General Support for Athletic Activity, Medial/Lateral Support, Moderate/Occasional Pain, Prevention, Recovery, Sprains, Strains, Weak, Sore Muscles & Injured Knees
Size: Adjustable
Sizes Available: One Size - Adjustable
Support Level: Moderate
Support and Compression Level: Moderate
Type: Brace
Where to Measure: Measure around knee.
eClass 14 Classification Group: 34200201

Nexcare™ Cushioned Adhesive Pad AWP34, 3 in x 4 in

3M ID 70005097616 UPC 00051131197732

Details

Provides cushioned protection to minor burns, scrapes, cuts and abrasions
Strong adhesive stays on during water activities
Absorbent pad wicks fluid and doesn't stick to your wound
Conforms comfortably to your skin and moves with you during activity
B

Typical properties

Application: Waterproof
Brands: Nexcare™
Factory ISO Certification: No ISO Certification information available
Material: Foam
Package Contents: 4 Pack
Product Color: Tan
Product Type: Pad with Adhesive
Properties: Non-Stick Pad
Sizes Available: 4 ct. (Cat# AWP34): Dressing Size: 3" x 4"; Pad Size: 1-9/16" x 2-5/8"
Solution for: Cushioning, For Large Wounds, Waterproof
Waterproof: No
Wound Type: Cuts / Scrapes / Abrasions, Minor Burns
eClass 14 Classification Group: 34400201

Dimensions and Classifications

Overall Length (Imperial): 4 in
Overall Length (Metric): 101.6 mm
Overall Width (Imperial): 3 in
Overall Width (Metric): 76.2 mm

Nexcare™ Waterproof Bandages, Cool Collection 594-20

3M ID 70005224806 UPC 00051131669901

Details

Waterproof bandage stays on skin in the bath, shower or pool
Covers and protects cuts, scrapes and blisters
Unique shape provides a better seal around the pad
Stays on when you sweat
Leaves minimal adhesive residue on skin when removed
Breathable con

Typical properties

Application: Kids, Waterproof
Brands: Nexcare™
Factory ISO Certification: No ISO Certification information available
Material: Clear Film
Package Contents: 20 pack
Product Color: Multi-color
Product Type: Bandage
Properties: Breathable, Non-Stick Pad, Waterproof
Sizes Available: 20 ct. at 1-1/16" x 2-1/4"
Solution for: Kids, Waterproof
Waterproof: Yes
Wound Type: Cuts / Scrapes / Abrasions
eClass 14 Classification Group: 34400201

Dimensions and Classifications

Overall Length (Imperial): 2.244 in
Overall Length (Metric): 57 mm
Overall Width (Imperial): 1.024 in
Overall Width (Metric): 26 mm

ACE™ Brand Wrist Support

3M ID COBBLW014104 UPC 00051131198258

Details

New! Larger perforations for ultimate breathability
Provides moderate support and adjustable compression for weak, sore, or injured joints
Contoured design conforms to your wrist
Soft, neoprene-blend material is breathable to help keep you cool and dry

Typical properties

Body Part: Wrist
Brands: ACE™
Condition: Sprains, Strains
Factory ISO Certification: No ISO Certification information available
Latex-free: Yes
Material: Neoprene, Nylon, Polyester, Spandex
Package Contents: 1/pack
Product Color: Black
Product Type: Support
Properties: Adjustable, Breathable, Non Latex Containing
Size: Adjustable
Sizes Available: One Size - Adjustable
Support Level: Moderate
Support Level Description: Provides adjustable levels of compression, support and therapeutic heat retention to help relieve symptoms associated with strains, sprains, arthritis and muscle pain.
Type: Support
eClass 14 Classification Group: 34200201

ACE™ Deluxe Ankle Brace 207736, One Size Adjustable

3M ID 70007019816 UPC 00051131203877

Details

Quick lacing and strap system provides custom fit
Moderate-support design offers customizable levels of compression and support
Adjustable features for custom comfort
Gel cushioning around your Achilles tendon and ankle bone for comfort
Designed to co

Typical properties

Body Part: Ankle
Brands: ACE™
Factory ISO Certification: No ISO Certification information available
Fit Range: 7.5" to 11"
Latex-free: No
Material: Elastane, Neoprene, Nylon, Polyester
Performance Zone Category: Return to Activity
Product Color: Black
Product Type: Brace
Properties: Adjustable, Gel Cushion, Odor Control
Size: Adjustable
Sizes Available: One Size - Adjustable
Support Level: Moderate
Type: Brace
Where to Measure: Measure around ankle.
eClass 14 Classification Group: 34200201

Nexcare™ Foot Protection Tape FPT-05, 1 in x 5 yds (2.54 cm x 4.57 m)

3M ID 70005268860 UPC 00051141994970

Details

Water-resistant formula
Conforms to toes, heels, ankles and more
Flexible material moves with you
Breathable design provides lasting comfort
Tears easily
Transparent look for discreet comfort
Package contents: 1 roll
Size: 1 inch x 5 yds
Color: c

Typical properties

Application: Blister, Hands / Heels, Hard-to-Cover Areas, Skin Care, Sports
Brands: Nexcare™
Factory ISO Certification: No ISO Certification information available
Latex: No
Package Contents: 1 Pack
Product Color: Transparent
Product Type: Tape
Properties: Conformable, Cushioning, Easy Tear
Sizes Available: 1" x 180" (5 yds.); 2,54 cm x 4,57 m
Solution for: Blister, Hands/Heels, Hard-to-Cover Areas, Skin Care, Sports
Units per Pack: 1
Wound Type: Blisters
eClass 14 Classification Group: 34180101

Dimensions and Classifications

Overall Length (Imperial): 1.77 in
Overall Length (Metric): 4.5 cm
Overall Width (Imperial): 9.84 in
Overall Width (Metric): 2.5 cm

Nexcare™ Gentle Removal Eye Patch - Regular KRR-14, 2.24 in x 3.15 in (57 mm x 80 mm)

3M ID UU010125225 UPC 00051131216808

Details

VERSATILE FIT: Sized for adults and children, featuring gentle hypoallergenic adhesive that is ideal for sensitive skin

REPOSITIONABLE ADHESIVE EYEPATCH: Proprietary silicone adhesive technology allows easy repositioning with gentle removal and a secure

Typical properties

Age Group: Adult

Brands: Nexcare™

Factory ISO Certification: No ISO Certification information available

Package Contents: 14 Pack

Package Quantity: 14

Patches per Box: 14

Product Color: White

Product Type: Eye Patch

Properties: Breathable, Repositionable

Solution for: Pain-Free / Gentle Removal

eClass 14 Classification Group: 34180405

Dimensions and Classifications

Overall Length (Imperial): 3.15 in

Overall Width (Imperial): 2.24 in

ACE™ Brand Posture Corrector, One Size - Adjustable

3M ID CBGBLRUS1521 UPC 00051131222205

Details

Stretches chest and shoulder muscles to promote better posture
Fully adjustable shoulder straps provide personalized comfort
Hook-and-loop straps offer a secure fit
Stretchy neoprene materials contour to your body for a streamlined look
Repositionable

Typical properties

Body Part: Back
Brands: ACE™
Factory ISO Certification: No ISO Certification information available
Latex-free: Yes
Material: Nylon, Polyester, Spandex
Product Color: Black
Product Type: Support
Size: Adjustable
eClass 14 Classification Group: 34200201

3M™ Attest™ Auto-Reader for EO, 390G, 1/CS

3M ID 7100214867 UPC 00707387767143

Details

10-well auto-reader designed for use with 3M™ Attest™ Rapid Readout Biological Indicator 1294 for Ethylene Oxide Sterilization and 3M™ Attest™ Rapid Readout Biological Indicator Test Pack 1298 for Ethylene Oxide Sterilization
Biological indicator results

Typical properties

Biological Indicator System: Rapid
Brands: Attest™
Catalog Number: 390G
Cladimed Code: Non applicable
Compatible Indicator: 1294, 1298, 1298F
Factory ISO Certification: No ISO Certification information available
Incubation Period: 4 Hour
Maximum Temperature (Celsius): 37 °C
Maximum Temperature (Fahrenheit): 98.6 °F
Number of Wells: 10
Product Type: Incubator
Sterilization Method: Ethylene Oxide (EO)
Total Units per Case: 1 per Case

3M™ Vetrap™ Bandaging Tape 1418D Rundown Patch

3M ID 7010604499

Typical properties

Brands: 3M™

Factory ISO Certification: No ISO Certification information available

Product Type: Rundown Patch

Waterproof: No

eClass 14 Classification Group: 34400201

3M™ Bair Hugger™ Warming Blanket 62200, Multi-position Upper Body, 10/Case

3M ID 7100212596 UPC 50707387790252

Details

Single-use, upper body forced-air warming blanket with excellent heat transfer
Can be used in supine, prone, lithotomy, lateral, robotics and beach chair patient positions

Multi-position blanket offers optimal patient body surface coverage(1) and fast a

Typical properties

Application: Medical

Blanket Type: Upper Body

Brands: Bair Hugger™

Clinical Area: OR, PACU, Pre-op

Drape Length: 78 in

Drape Length (Metric): 198 cm

Drape Width: 24 in

Drape Width (Metric): 61 cm

Factory ISO Certification: No ISO Certification information available

Product Type: Blanket

Quantity: 10 Case

Total Units per Case: 10 per Case

Units per Pack: 10

eClass 14 Classification Group: 34540392

Dimensions and Classifications

Overall Length (Imperial): 78 in

Overall Length (Metric): 198 cm

Overall Width (Imperial): 24 in

Overall Width (Metric): 60 cm

3M™ Tegaderm™ I.V. Advanced Securement Dressing

Details

A line of IV dressings comprehensively designed to help provide advanced IV and central line catheter securement

Dressing has a stabilization border, transparent window, pattern-coated adhesive, deep notch and tape strip to provide a secure hold, site vi

Typical properties

Brands: Tegaderm™

Cladimed Code: F51CA07,F51CA99

Clinical Sub-Area: Orthopedics

Condition: I.V. Related

Department: Cardiovascular, Critical Care, Dialysis Center, EMERGENCY, I.V. Therapy, Intensive Care Unit, Medical-Surgical, Oncology, Operating Room-Surgery, Pediatrics, Radiology, Urgent Care, Wound Care

Dressing Type: Film

Dressing and Device Securement Condition Type: Adhesive Trauma, Skin Injuries-Mechanical, Tube & Device Securement-Lightweight Tubes & Devices

Factory ISO Certification: No ISO Certification information available

Hypoallergenic: Yes

IV Related Condition Type: Arterial Catheter, CVC Dialysis, CVC Implanted Port, CVC PICC, CVC Short-Term, CVC Tunneled, Epidural Catheter, PIV

Latex: No

Product Color: Transparent

Product Type: Securement Dressing

Product Use: Arterial Catheter, CVC, Dialysis, Epidural Catheter, PICC, PIV

Units per Pack: 25 , 50 , 100

eClass 14 Classification Group: 34180202

Dimensions and Classifications

Overall Length (Imperial): 0.5 in, 0.75 in, 1.75 in, 1.771 in, 2.25 in, 2.75 in, 3.375 in, 4.75 in, 6.125 in

Overall Length (Metric): 1.27 cm, 1.905 cm, 4.5 cm, 5.72 cm, 7 cm, 8.5 cm, 12 cm, 15.5 cm, 85.725 mm

Overall Width (Imperial): 0.5 in, 1.378 in,

3M™ Wound Cleanser

3M ID B10429501

Typical properties

Brands: 3M™

eClass 14 Classification Group: 47010203

3M™ PICC/CVC Securement Device + 3M™ Tegaderm™ CHG Chlorhexidine Gluconate I.V. Securement Dressing

Details

Single package with device and antimicrobial CHG dressing
Sutureless securement balances reliable adhesion with gentleness to skin
Designed to be worn for up to 7 days
Skin-friendly materials improve comfort and mobility
Accommodates the majority of P

Typical properties

Boxes per Case: 4.0,-12345.0
Brands: Tegaderm™
Catalog Number: 1879-2100,1879-2100K,1877-2100,1877-2100K,1879R-2100,1877R-2100
Cladimed Code: E52EC1
Condition: I.V. Related
Department: Cardiovascular, EMERGENCY, Home Care, Home Infusion, Long-Term Acute Care, Long-Term Care, Medical-Surgical, Oncology, Operating Room-Surgery, Out Patient Infusion, Radiology, Urgent Care
Device Length (Imperial): 2.125 in
Device Length (Metric): 5.4 cm
Device Width (Imperial): 2 in
Device Width (Metric): 5.1 cm
Factory ISO Certification: No ISO Certification information available
IV Related Condition Type: Arterial Catheter, CVC Dialysis, CVC Implanted Port, CVC PICC, CVC Short-Term, CVC Tunneled, Epidural Catheter, PICC, PIV
Inner Packs per Case: 4 Cartons per Case
Latex: No
Product Form: Bulk
Product Type: Securement Dressing
Product Use: CVC, PICC
Sterile: No, Yes
Total Units per Case: 80 per Case, 250 per Case
Units per Case: 80.0,250.0
Units per Inner Pack: 20 per Carton
Units per Pack: 20
eClass 14 Classification Group: 34180202

Dimensions and Classifications

Overall Length (Imperial): 4.5 in, 6.125 in
Overall Length (Metric): 11.5 cm, 15.5 cm
Overall Width (Imperial): 3.5 in, 4 in
Overall Width (Metric): 8.5 cm, 10 cm

3M™ Tegaderm™ +Pad Film Dressing with Non-Adherent Pad, 3500 Series

Details

Provide a barrier to bacteria and viruses– Sterile film dressing provides an effective bacterial and viral barrier.*

Practical for patients – Waterproof film lets patients shower without removing the dressing *if the dressing is fully intact and not li

Typical properties

Brands: Tegaderm™

Catalog Number: 3589,3588,3587,3586,3584,3593,3582,3591,3590

Cladimed Code: F51CA99

Clinical Area: Cardiovascular, Dialysis Centre, Emergency Medical Services (EMS), Emergency Room, I.V. Therapy, Intensive Care, Oncology, Pediatric, Radiology, Surgery

Clinical Sub-Area: Obstetrics and Gynaecology, Orthopedics

Condition: I.V. Related, Pressure Ulcer, Wound Care

Department: Cardiovascular, Dialysis Center, EMERGENCY, Intensive Care Unit, Labor & Delivery, Medical-Surgical, Oncology, Operating Room-Surgery, Orthopedics, Pediatrics, Radiology, Urgent Care, Wound Care

Dressing Type: Island

Factory ISO Certification: No ISO Certification information available

Hypoallergenic: Yes

IV Related Condition Type: Arterial Catheter, CVC Dialysis, CVC PICC, CVC Short-Term, CVC Tunneled, PICC

Inner Packs per Case: 4 Cartons per Case

Latex: No

Product Color: Transparent

Product Type: Film Dressing with Pad, Island

Therapeutic Area and Conditions: Abrasions, Burns, Incisions, Laceration, Surgical Wounds

Total Units per Case: 100 per Case, 200 per Case

Units per Inner Pack: 25 per Carton, 50 per Carton

Units per Pack: 25 , 50

Waterproof: Yes

Wound Dressing Length (Metric): 5 cm, 15 cm

Wound Dressing Width (Metric): 7 cm, 15 cm

eClass 14 Classification Group: 34400201

Dimensions and Classifications

Overall Length (Imperial): 2.75 in, 4 in, 4.125 in, 6 in, 8 in, 10 in, 13.75 in

Overall Length (Metric): 6.98 cm, 7 cm, 10 cm, 10.16 cm, 10.47 cm, 15 cm, 15.24 cm, 20 cm, 20.32 cm, 25 cm, 25.4 cm, 34.925 cm, 35 cm

Overall Width (Imperial): 2 in, 2.375 i

3M™ Tegaderm™ High Gelling Alginate Dressing

Details

Gel forming for optimal moist wound healing environment
Supports healing – Maintains optimal moisture levels needed for healing tissue
Highly conformable primary wound dressing
Compatible with 3M cover dressings

Typical properties

Brands: Tegaderm™
Factory ISO Certification: No ISO Certification information available
eClass 14 Classification Group: 34210402

Dimensions and Classifications

Overall Length (Imperial): 2 in, 4 in
Overall Length (Metric): 50.8 mm, 101.6 mm
Overall Width (Imperial): 1 in, 4 in
Overall Width (Metric): 25.4 mm, 101.6 mm

3M™ Littmann® Lightweight II S.E. Stethoscope

Details

Lightest weight of all Littmann adult stethoscopes at just 118 grams
Dual-sided chestpiece provides versatility of both a tunable diaphragm and open bell
Teardrop-shaped chestpiece for easier positioning under blood pressure cuffs and around bandages
T

Typical properties

Application: Physical Assessment and Blood Pressure, Physical Assessment and Diagnosis
Approved Environmental Marketing Claim (EMC): 3M™ Littmann® tubing does not contain phthalate plasticizers. It improves resistance to skin oils and alcohol, and is less likely to pick up stains.
Binaural Construction: Single lumen
Brands: Littmann®
Chestpiece Color: Gray
Chestpiece Finish: Metal/Resin Composite
Chestpiece Size: 2.12 Inch / 5.4 cm
Chestpiece Technology: Double-sided
Chestpiece Weight: 1.65 Ounce
Chestpiece Weight (Metric): 47 g
Cladimed Code: K50BE01
Clinical Area: Cardiovascular, Surgery
Clinical Sub-Area: Post Anesthetic Care Unit
Diaphragm Diameter (Imperial): 2.12 in
Diaphragm Diameter (Metric): 5.4 cm
Diaphragm Material: Epoxy/Fiberglass
Diaphragm Shape: Teardrop
Diaphragm Type: Tunable Diaphragm
Eartip Type: Soft Sealing
Environmental claim being made: Yes
Environmental claim relates to: Product
Evidence for Claim: Self Certified
Extra Eartips: No
Factory ISO Certification: No ISO Certification information available
Headset Material: Anodized Aluminum
Model: Lightweight II S.E.
Net Weight (Imperial): 0.26 lb
Net Weight (Metric): 118 g
Occupation: EMT/EMS, Medical Assistant, Nurse, Nursing Student
Patient: Adult
Performance: 6
Product Type: Stethoscope
Special Adaptors: No
Tube Color: Black, Burgundy, Caribbean Blue, Ceil Blue, Pearl pink
Tube Construction: Single lumen

Tunable Diaphragm: Yes
Warranty Period: 2 yr
eClass 14 Classification Group: 34340191

Dimensions and Classifications

Overall Length (Imperial): 28 in
Overall Length (Metric): 71 cm

3M™ Littmann® Tunable Diaphragm and Rim Assembly, 33474, Black

3M Product Number 33474 3M ID 7100256191 UPC 00707387808754

Details

Available in sizes to fit Littmann stethoscope models that feature tunable technology

Rim available in black and gray to match nonchill bell sleeve and/or eartips

Typical properties

Brands: Littmann®

Diaphragm Type: Tunable Diaphragm

Product Type: Spare Parts Kit

eClass 14 Classification Group: 34340191

Vetrap Bandaging Tape

3M ID B00003186 UPC 04064035091910

Details

- Immobilize limbs for splints and casts
- Provide support for sprains and strains
- Maintains even compression over time
- Sticks to itself without pins or tape
- Bandage sticks to itself, but not to fur
- Clean, straight tearing
- Available in multiple colors

Typical properties

- Brands: Vetrap™
- Catalog Number: 1410R-18,1404BK-36,1410HG-18,1404B-36,1410W-18,1410B-18,1404W-36,1410BK-18,1404R-36,1404HG-36
- Closure Method: Self-adhering
- Factory ISO Certification: No ISO Certification information available
- Package Contents: 1 Roll/Pack
- Pharmacy Barcode: 2180461
- Product Color: Assorted Colors, Black, Blue, Hunter Green, Red, White
- Product Type: Bandaging Tape, Veterinary Elastic Adhesive Tape
- Sterile: Yes
- eClass 14 Classification Group: 34200190

Dimensions and Classifications

- Overall Length (Imperial): 4.921 yd
- Overall Length (Metric): 4.5 m
- Overall Width (Imperial): 1.57 in, 3.93 in
- Overall Width (Metric): 5 cm, 10 cm

3M™ Steri-Drape™ Medium Aperture Drape with Wide Adhesive Aperture

1033NS

3M ID 7100024307 UPC 00707387454579

Details

Impervious polyethylene film provides a barrier to liquids, reducing exposure to blood and body fluids

Adhesive film isolates the surgical site from lid margins, eyelashes and eyebrows to help reduce the risk of surgical site contamination

Matte finish

Typical properties

Brands: Steri-Drape™

Factory ISO Certification: No ISO Certification information available

Material: Plastic

Product Type: Aperture Drape

Product Use: Surgical Sheet

3M™ Steri-Drape™ Medium Drape with Aperture 1030NS

3M ID 7000053401 UPC 00707387029357

Details

Impervious polyethylene film provides a barrier to liquids, reducing exposure to blood and body fluids

Adhesive film isolates the surgical site from lid margins, eyelashes and eyebrows to help reduce the risk of surgical site contamination

Matte finish

Typical properties

Brands: Steri-Drape™

Factory ISO Certification: No ISO Certification information available

Material: Plastic

Product Type: Aperture Drape

Product Use: EENT

3M™ Steri-Drape™ 2 Incise Drape, 2040, Incise Area 28 cm x 41 cm (11 in x 16 1/8 in), 10/Carton, 4 Cartons/Case

3M ID 7100238520 UPC 50707387793055

Details

Drape creates a sterile surface at the beginning of surgery
Drape adhesive adheres securely to skin and immobilizes bacteria
Plastic film provides a barrier to liquids
Breathable film is conformable for easy application, even around difficult anatomica

Typical properties

Accessories: Miscellaneous
Brands: Steri-Drape™
Clinical Area: Surgery
Clinical Sub-Area: Obstetrics and Gynaecology, Orthopedics
Factory ISO Certification: No ISO Certification information available
Features: Clear
Model: 2040
Procedure: General Surgery
Product Type: Incise Drapes
Product Type Free Format: Incise Drapes
Product Use: Incise
Sterile: Yes
Units per Pack: 10

Dimensions and Classifications

Overall Length (Imperial): 11 in
Overall Length (Metric): 28 cm
Overall Width (Imperial): 16.125 in
Overall Width (Metric): 41 cm

**3M™ Steri-Drape™ 2 Incise Drape 2035NS, Bulk, Non sterile, Incise
area 3
7/8 IN x 7 7/8 IN, 200/CS**

3M ID 7000053487 UPC 00707387098551

Details

Drape creates a sterile surface at the beginning of surgery
Drape adhesive adheres securely to skin and immobilizes bacteria
Plastic film provides a barrier to liquids
Breathable film is conformable for easy application, even around difficult anatomica

Typical properties

Brands: Steri-Drape™
Factory ISO Certification: No ISO Certification information available
Product Type: Incise Drapes
Product Use: Incise

Dimensions and Classifications

Overall Length (Metric): 20 cm
Overall Width (Metric): 20 cm

3M™ Steri-Drape™ 2 Incise Drape, 2050, Incise Area 60 cm x 60 cm (23 1/2 in x 23 1/2 in), 10/Carton, 4 Cartons/Case

3M Product Number 2050 3M ID 7100238518 UPC 50707387793079

Details

Drape creates a sterile surface at the beginning of surgery
Drape adhesive adheres securely to skin and immobilizes bacteria
Plastic film provides a barrier to liquids
Breathable film is conformable for easy application, even around difficult anatomica

Typical properties

Accessories: Miscellaneous
Brands: Steri-Drape™
Clinical Area: Surgery
Clinical Sub-Area: Obstetrics and Gynaecology, Orthopedics
Factory ISO Certification: No ISO Certification information available
Features: Clear
Model: 2050
Procedure: General Surgery
Product Type: Incise Drapes
Product Type Free Format: Incise Drapes
Product Use: Incise
Sterile: Yes
Units per Pack: 10

Dimensions and Classifications

Overall Length (Imperial): 23.5 in
Overall Length (Metric): 60 cm
Overall Width (Imperial): 23.5 in
Overall Width (Metric): 60 cm

3M™ Steri-Drape™ 2 Incise Drape 2050NS, 200/Case

3M ID 7000053491 UPC 00707387098599

Details

Drape creates a sterile surface at the beginning of surgery
Drape adhesive adheres securely to skin and immobilizes bacteria
Plastic film provides a barrier to liquids
Breathable film is conformable for easy application, even around difficult anatomica

Typical properties

Brands: Steri-Drape™
Cladimed Code: E51BA99
Factory ISO Certification: No ISO Certification information available
Product Type: Incise Drapes
Product Use: Incise

3M™ Steri-Drape™ 2 Incise Drape 2051NS, Incise area 19 inches x 17 inches (50cm x 45cm), 150/Case

3M ID 7000053492 UPC 00707387098605

Details

Drape creates a sterile surface at the beginning of surgery
Drape adhesive adheres securely to skin and immobilizes bacteria
Plastic film provides a barrier to liquids
Breathable film is conformable for easy application, even around difficult anatomica

Typical properties

Brands: Steri-Drape™
Cladimed Code: E51BA99
Factory ISO Certification: No ISO Certification information available
Product Type: Incise Drapes
Product Use: Incise

Dimensions and Classifications

Overall Length (Metric): 85 cm
Overall Width (Metric): 60 cm

3M™ Single-use Clipper Blade Assembly 9670

3M ID 7000030241 UPC 00707387561444

Details

Removes all types of head and body hair - fine or coarse, wet or dry - faster than previous 3M clippers

Reduces risk of cross-contamination with single-use blades

Blade easily snaps-on and pops-off

Blade can be used flat or at a slight angle to the skin

Typical properties

Brands: 3M™

Factory ISO Certification: No ISO Certification information available

Head Type: Fixed

Product Color: Black

Therapeutic Area and Conditions: Pre-Operative Hair Removal

Units per Pack: 50

eClass 14 Classification Group: 47040590

3M™ Avagard™ Surgical and Healthcare Personnel Hand Antiseptic with Moisturizers

Details

FDA NDA approved waterless, brushless surgical hand scrub
Meets surgical hand antiseptic guidelines from the CC, AORN, WHO and INS, helping you go into each surgery with confidence
Proven efficacy equips you to protect your patients from SSIs by providi

Typical properties

Brands: Avagard™
Clinical Area: Surgery
Container Volume: 16 Fluid Ounce (US) / 500 mL, 40.6 Fluid Ounce (US) / 1200 mL
Factory ISO Certification: No ISO Certification information available
Model: 9200, 9216
Product Type: Hand Sanitizer, Surgical Scrub
Volume (Imperial): 16.9 fl oz
Volume (Metric): 500 mL
eClass 14 Classification Group: 30300401

3M™ Bair Hugger™ + Warming Gown

Details

Provides comfort and clinical warming throughout perioperative process
Eliminates the need to reposition the gown in many procedures by providing one hose port for prewarming or comfort warming, and two hose ports for clinical warming
Can improve patient

Typical properties

Brands: Bair Hugger™
Clinical Area: OR, PACU, Pre-op
Closure Style: Tie Neck & Back
Factory ISO Certification: No ISO Certification information available
Gown Circumference (Metric): 163 cm
Gown Size: Extra Large, Small, Standard
Model: 81002, 81102, 81202
Product Type: Gown
Quantity: 20 Case, 30 Case
Reusable: No
Size: Small, Standard, X-Large
Style: Plus Gown
Sweep: 122 in +/- 1, 55 in +/- 1, 64 in +/- 1
Sweep (Metric): 140, 163, 310
Units per Pack: 30
eClass 14 Classification Group: 34540392

Dimensions and Classifications

Overall Length (Imperial): 44 in, 51 in
Overall Length (Metric): 111 cm, 130 cm
Overall Width (Metric): 130 cm

3M™ Bair Hugger™ Warming Blanket, 63700

3M ID B00042301

Details

Underbody design warms the patient while providing full, unrestricted patient access

Typical properties

Brands: Bair Hugger™
eClass 14 Classification Group: 34540392

3M™ Bair Hugger™ Warming Blanket 55000, Large Pediatric Underbody, 10/Case

3M ID 7100212597 UPC 50707387790153

Details

Single-use underbody forced-air warming blanket with excellent heat transfer
Consists of a soft, comfortable material
Helps maintain normothermia, which can reduce the rate of complications, including surgical site infection (SSI)(1,2)
Provide safe, ef

Typical properties

Application: Medical
Blanket Type: Underbody
Brands: Bair Hugger™
Cladimed Code: Non applicable
Clinical Area: Cardiac & Specialty, OR, Pediatric, Underbody
Drape Length: 24 in
Drape Length (Metric): 61 cm
Drape Width: 24 in
Drape Width (Metric): 61 cm
Factory ISO Certification: No ISO Certification information available
Product Type: Blanket
Quantity: 10 Case
Total Units per Case: 10 per Case
Units per Pack: 10
eClass 14 Classification Group: 34540392

Dimensions and Classifications

Overall Length (Imperial): 60 in
Overall Length (Metric): 81 cm
Overall Width (Imperial): 32 in
Overall Width (Metric): 152 cm

3M™ Microfoam™ Surgical Tape, 1528

Details

Conformable: Multi-directional stretch to accommodate swelling and movement
Tape material: Elastic foam tape not made with natural rubber latex
Provides cushioning

Typical properties

Brands: Microfoam™
Factory ISO Certification: No ISO Certification information available
Hypoallergenic: Yes
Material: Elastic Foam
Product Color: White
Product Type: Surgical Tape
Therapeutic Area and Conditions: Highly conformable foam surgical tape
Units per Pack: 3 , 4 , 6 , 12

Dimensions and Classifications

Overall Length (Imperial): 5.5 yd
Overall Length (Metric): 5 m
Overall Width (Imperial): 1 in, 2 in, 3 in, 4 in
Overall Width (Metric): 2.5 cm, 5 cm, 7.5 cm, 10 cm

3M™ Attest™ Auto-reader, 390, 1 EA

3M ID 7100214718 UPC 00707387767136

Details

10-well auto-reader designed for use with 3M™ Attest™ Rapid Readout Biological Indicator 1291 for Steam Sterilization and 3M™ Attest™ Rapid Readout Biological Indicator 1292 for Steam Sterilization, 3M™ Attest™ Rapid Readout Biological Indicator Test Pack

Typical properties

Biological Indicator System: Rapid
Brands: Attest™
Catalog Number: 390
Cladimed Code: Non applicable
Compatible Indicator: 1291, 1292, 1296, 1296F, 41382, 41382F
Factory ISO Certification: No ISO Certification information available
Incubation Period: 3 Hour
Maximum Temperature (Celsius): 60 °C
Maximum Temperature (Fahrenheit): 140 °F
Number of Wells: 10
Product Type: Incubator
Sterilization Method: Steam
Total Units per Case: 1 per Case

Dimensions and Classifications

Overall Height (Imperial): 3.25 in
Overall Height (Metric): 82.55 mm
Overall Length (Imperial): 8.75 in
Overall Length (Metric): 222.25 mm

3M™ EO (ethylene oxide) Abator Model 50AN System, 220-230V/1PH, 1 EA/CTN

3M ID 7000002785 UPC 00707387524302

Details

Converts EO to carbon dioxide and water with up to 99.9% efficiency
Eliminates 99+% of EO emissions
Allows connection for two Steri-Vac Sterilizers

Typical properties

Brands: 3M™
Clinical Area: Medical Device Reprocessing Department
Environmental claim being made: Yes
Evidence for Claim: Externally Certified
Factory ISO Certification: No ISO Certification information available
Industries: Life Sciences
Model: 50AN
Product Type: Sterilizer
Product Use: Accessory
Sterilization Method: Ethylene Oxide (EO)
Units per Box: 1.0
eClass 14 Classification Group: 34419090

Dimensions and Classifications

Overall Height (Metric): 80 cm
Overall Width (Metric): 82 cm

3M™ Scotchcast™ Conformable Roll Splint

3M ID B00046075

Details

Splint can be customized and cut to the exact length needed for less waste and cost-effective product use

Easy-to-use, delivery system helps ensure freshness of splinting material and reduced waste

All-in-one splint allows for easy application and time

Typical properties

Brands: Scotchcast™

eClass 14 Classification Group: 34200204

**3M™ Medical Tape 9832W, Single Sided Polyurethane on White 78#
Carrier,
CONFIGURABLE**

3M ID 7100013211

Details

Acrylic Adhesive
High Moisture Vapor Transmission Rate (MVTR) / Breathability
Fluid Resistant
Conformable

Typical properties

Brands: 3M™
Factory ISO Certification: No ISO Certification information available
Hypoallergenic: No
Latex: No
Product Color: Tan
eClass 14 Classification Group: 34180101

3M™ Scotchpak™ Polyester Backing Film Laminate, 1109, Config Roll

3M ID 7100000235

Details

Tan
Occlusive
Conformable
Controlled caliper

Typical properties

Backing (Carrier) Material: Polyester
Brands: Scotchpak™
Breathability: Occlusive
Caliper: 1.34 mils
Caliper (Metric): 34.0 µm
Catalog Number: 1109
Elongation CD: 50%
Elongation MD: 70%
Factory ISO Certification: No ISO Certification information available
MVTR (g/m²/24 hr): 0.3
Oxygen Transmission (cc/m²/24hr): 2
Product Color: Tan
Product Type: Transdermal Backing
Sample Roll: 6 in x 25 yds
Sample Roll (Metric): 15 cm x 23 m
Tensile CD: 15 lbs/in
Tensile CD (Metric): 66.7 N/25.4 mm
Tensile MD: 12 lbs/in
Tensile MD (Metric): 53.4 N/25.4 mm
eClass 14 Classification Group: 41011103

Dimensions and Classifications

Overall Length (Imperial): 1500 yd
Overall Length (Metric): 1829 m
Overall Thickness (Imperial): 3.6 mil
Overall Thickness (Metric): 91.4 micron
Overall Width (Imperial): 40.157 in
Overall Width (Metric): 102 cm

3M™ Ranger™ Blood/Fluid Warming Unit, 24500, 120V-ENG-B, 1 Each

3M ID 7100235902 UPC 00707387803292

Details

- Compact space-saving design
- Large, easy-to-read temperature display
- Audible/visible, over/under temperature alarm indicators
- Convenient over-temperature test function
- Built-in IV pole clamp for secure hold
- Highly conductive warming plates maximize he

Typical properties

- Brands: Ranger™
- Clinical Area: ER, OR
- Device Rating: 100-120 VAC / 220-240 VAC
- Factory ISO Certification: No ISO Certification information available
- Fluid Type: Blood/Fluid
- Primary Alarm: Over-temperature primary set point: 43°C
- Product Type: Warming Unit
- Quantity: 1 each
- Secondary Alarm: Over-temperature secondary set point: 44°C
- Set Point Temperature: 41° C
- eClass 14 Classification Group: 34540392

Dimensions and Classifications

- Overall Diameter (Imperial): 10 in
- Overall Diameter (Metric): 25 cm
- Overall Height (Imperial): 4.5 in
- Overall Height (Metric): 11.4 cm
- Overall Width (Imperial): 7.5 in
- Overall Width (Metric): 19.1 cm

3M™ Tegaderm™ CHG Chlorhexidine Gluconate I.V. Port Dressing

Details

Antimicrobial protection – Integrated CHG gel pad provides immediate and continuous antimicrobial protection

Easy to remove – Adhesive-free window minimizes adhesive contact with non-coring needle and patient's skin, reducing the risk of the dressing sti

Typical properties

Boxes per Case: 4.0,-12345.0

Brands: Tegaderm™

Catalog Number: 1665,1665NS

Condition: I.V. Related

Department: Oncology

Dressing Type: Film

Factory ISO Certification: No ISO Certification information available

IV Related Condition Type: CVC Implanted Port

Inner Packs per Case: 4 Cartons per Case

Latex: No

Product Form: Bulk

Product Type: Antimicrobial Dressing

Product Use: Arterial Catheter, CVC, Dialysis, Epidural Catheter, PICC, PIV

Sterile: No, Yes

Total Units per Case: 100 per Case, 250 per Case

Units per Case: 250.0,100.0

Units per Inner Pack: 25 per Carton

Units per Pack: 25

eClass 14 Classification Group: 34180202

Dimensions and Classifications

Overall Length (Imperial): 4.75 in

Overall Length (Metric): 12 cm

Overall Width (Imperial): 4.75 in

Overall Width (Metric): 12 cm

3M™ Tegaderm™ High Performance Foam Adhesive Dressing

Details

Multi-layer construction of the foam dressing results in excellent fluid management, which is intended to provide long wear time
Spoke delivery system allows easy, one-handed application and removal
Adapts to changing levels of exudate to maintain moist

Typical properties

Adhesive: Yes
Adhesive Type: Acrylate, High Performance
Backing Material: Foam
Body Part: Heel
Border: No
Boxes per Case: 4.0,6.0
Brands: Tegaderm™
Catalog Number: 16010,90611,90610,90613,90612,90615,90614,90616,90619
Cladimed Code: F51BB
Clinical Area: Cardiovascular, Dialysis Centre, Emergency Medical Services (EMS), Emergency Room, I.V. Therapy, Intensive Care, Oncology, Radiology, Surgery
Condition: Dressing & Device Securement, Pressure Ulcer, Wound Care
Department: Cardiovascular, EMERGENCY, Home Care, Intensive Care Unit, Long-Term Care, Medical-Surgical, Oncology, Operating Room-Surgery, Pediatrics, Radiology, Urgent Care, Wound Care
Dressing and Device Securement Condition Type: Skin Injuries-Allergic & Irritant Contact Dermatitis
Factory ISO Certification: No ISO Certification information available
Features: Wrap for Hard to Dress Areas
Hypoallergenic: No
Inner Packs per Case: 4 Cartons per Case, 6 Cartons per Case
Latex: No
Pressure Ulcer Condition Type: Prevention, Stage 2, Stage 3, Stage 4, Unstageable
Product Type: Foam Dressing
Shape: Oval, Square
Size: Large, Medium, Mini, Small
Therapeutic Area and Conditions: Surgical Wounds
Total Units per Case: 20 per Case, 30 per Case, 40 per Case, 500 per Case
Units per Case: 40.0,500.0,20.0,30.0
Units per Inner Pack: 5 per Carton, 10 per Carton
Units per Pack: 5 , 10
Wound Care Condition Type: Abrasions, Closed Intact Surgical Wound, Donor Sites, Friction, Laceration, Neuropathic Ulcers, Open Surgical Wounds, Skin Tear, Superficial Partial Thickness Burns, Venous Leg Ulcer
Wound Dressing Length (Imperial): 0.394 in, 0.984 in, 1.22 in, 2.165 in, 2.362 in, 2.992 in, 3.937 in, 5.512 in
Wound Dressing Length (Metric): 2.5 cm, 3.1 cm, 5.5 cm, 6 cm, 7.6 cm, 10 cm, 10 mm, 14 cm

Wound Dressing Width (Imperial): 0.433 in, 0.984 in, 1.496 in, 2.165 in, 2.992 in, 3.937 in, 6.732 in

Wound Dressing Width (Metric): 1 cm, 2.5 cm, 3.8 cm, 5.5 cm, 7.6 cm, 10 cm, 17.1 cm

eClass 14 Classification Group: 34210409

Dimensions and Classifications

Overall Diameter (Metric): 13.9 cm

Overall Length (Imperial): 2.75 in, 3 in, 3.5 in, 4.5 in, 5.118 in, 5.625 in, 6.125 in, 8.75 in, 10.125 in

Overall Length (Metric): 6.985 cm, 7.6 cm, 7.62 cm, 8.8 cm, 11 cm, 13 cm, 14.3 cm, 15.6 cm, 22.225 cm, 25.72 cm

3M™ Steri-Strip™ Antimicrobial Skin Closures A1847, 1/2 inch x 4 inches (12mm x 100mm), 6 Strips/Envelope 50/Carton 4 Cartons/Case

3M ID 7000002719 UPC 30707387472987

Details

Iodophor adhesive – In vitro testing shows the iodophor adhesive used in the manufacture of antimicrobial skin closures has broad spectrum activity against the most common pathogens causing SSIs. (Reference on file)

Cost savings - A low cost alternative

Typical properties

Brands: Steri-Strip™

Condition: Skin Closure

Department: Critical Care, EMERGENCY, Intensive Care Unit, Labor & Delivery, Medical-Surgical, Operating Room-Surgery, Orthopedics, Pediatrics, Urgent Care, Wound Care

Factory ISO Certification: No ISO Certification information available

Latex: No

Product Color: Tan

Product Type: Skin Closures

eClass 14 Classification Group: 34180306

Dimensions and Classifications

Overall Length (Imperial): 4 in

Overall Length (Metric): 100 mm

Overall Width (Imperial): 0.5 in

Overall Width (Metric): 12 mm

3M™ Diaphoretic Foam Monitoring Electrode, 2200 Series

3M ID B00037601

Details

Solid gel conforms to the skin quickly allowing high-quality, uninterrupted traces
The gel's low chloride content minimizes skin irritation for increased patient comfort

Use of built-in abrader disc improves trace quality for better results
3M adhesive

Typical properties

Brands: Red Dot™

eClass 14 Classification Group: 34580108

3M™ Steri-Drape™ Hand Pack 9015, 7 per Carton / 2 Cartons per Case

3M ID 7000030253 UPC 00707387562694

Details

1 OP Tape, 4 Hand Towels, 1 Mayo Stand Cover, 2 Adhesive Towel Drapes, 1 Adhesive Drape Sheet (M), 1 Adhesive Drape Sheet (L), 1 Instrument Table Cover

Resistant to Strikethrough

Fluid Control Features

Fluid Control Features

Typical properties

Additional Drapes: Pack

Brands: Steri-Drape™

Cladimed Code: E51AG07

Factory ISO Certification: No ISO Certification information available

Product Color: Blue

Product Type: Hand Drape

Product Use: General Surgery

Units per Pack: 7

FUTURO™ Comfort Fit Compression Ankle Support, Adjustable

3M ID 70007070470 UPC 00051131224629

Details

Moderate support and adjustable compression for weak, sore or injured ankles
Designed for all-day and everyday comfort and support
Easy, step-in design
Ultra breathable and moisture wicking, neoprene blend material to keep you cool and dry
Soft inner

Typical properties

Body Part: Ankle
Brands: FUTURO™
Condition: Arthritis, Pinched Nerve, Plantar Fasciitis, Sprains, Strains, Swelling, Tendonitis
Factory ISO Certification: No ISO Certification information available
Material: Neoprene, Nylon, Polyester, Spandex
Product Color: Gray
Product Type: Support
Size: Adjustable
Support and Compression Level: Moderate
eClass 14 Classification Group: 34200201

3M™ Bair Hugger™ Warming Unit Replacement Hose, Model 90081, 1 EA

3M ID 7100087612 UPC 00707387774875

Details

Replaces 875 model hose

Typical properties

Brands: Bair Hugger™

Cladimed Code: F59AB99

Clinical Area: PACU, Pre-op

Factory ISO Certification: No ISO Certification information available

Hardware: Accessory

Model: 90081

Product Type: Accessory

Dimensions and Classifications

Overall Diameter (Imperial): 2.5 in

Overall Diameter (Metric): 6.4 cm

Overall Length (Imperial): 70 in

Overall Length (Metric): 178 cm

3M™ Ioban™ 2 Antimicrobial Incise Drape, 6600 Series

Details

Continuous antimicrobial activity: Ioban 2 Antimicrobial Incise Drape provides continuous broad-spectrum antimicrobial activity to help reduce the risk of surgical site contamination

Immobilizes bacteria: Ioban 2 Antimicrobial Incise Drape immobilizes bacteria

Typical properties

Cladimed Code: E51BA99

Factory ISO Certification: No ISO Certification information available

Features: Antimicrobial

Incise Area Length (Metric): 10 cm, 34 cm, 56 cm, 60 cm

Incise Area Width (Metric): 10 cm, 35 cm, 45 cm, 60 cm, 85 cm

Material: Fabric, Plastic

Model: 6635, 6640EZ, 6648EZ, 6650EZ, 6651EZ, 6651EZSB, 6661EZ

Procedure: General Surgery

Product Type: Incise Drapes

Product Type Free Format: Antimicrobial Incise Drape

Product Use: Incise

Sterile: Yes

Therapeutic Area and Conditions: Surgical Procedures

Units per Pack: 10 , 50

Dimensions and Classifications

Overall Length (Imperial): 23 in, 27.6 in, 33 in

Overall Length (Metric): 10 cm, 26 cm, 44 cm, 66 cm, 70 cm, 85 cm

Overall Width (Imperial): 17 in, 23 in

Overall Width (Metric): 20 cm, 35 cm, 45 cm, 60 cm, 85 cm

3M™ Steri-Drape™ Small Drape with Incise Film 1021NS Non-Sterile, 200/CS

3M ID 7000053459 UPC 00707387072803

Details

Impervious polyethylene film provides a barrier to liquids, reducing exposure to blood and body fluids

Adhesive film isolates the surgical site from lid margins, eyelashes, and eyebrows to help reduce the risk of surgical site contamination

Matte finish

Typical properties

Brands: Steri-Drape™

Factory ISO Certification: No ISO Certification information available

Material: Plastic

Product Type: Incise Drapes

Product Use: Surgical Sheet

3M™ Steri-Drape™ Small Drape with Incise Film and Pouch 1023, 10/Carton 4 Carton/Case

3M Product Number 1023 3M ID 7000002790 UPC 50707387446036

Details

Impervious polyethylene film provides a barrier to liquids, reducing exposure to blood and body fluids

Incise area gives complete coverage of lashes, lids, and brows for isolation of globe and incision area

Matte finish helps reduce glare from drape sur

Typical properties

Accessories: Bags and Pouches

Brands: Steri-Drape™

Factory ISO Certification: No ISO Certification information available

Features: Clear

Incise Area Length (Metric): 12.5 cm

Incise Area Width (Metric): 10 cm

Material: Plastic

Model: 1023

Procedure: EENT

Product Color: Transparent

Product Type: Ophthalmic Drape

Product Type Free Format: Drape

Product Use: EENT

Therapeutic Area and Conditions: Ophthalmic

Units per Pack: 10

Dimensions and Classifications

Overall Length (Imperial): 15 in

Overall Length (Metric): 40 cm

Overall Width (Imperial): 19 in

Overall Width (Metric): 49 cm

**3M™ Steri-Drape™ Gynaecological Drape with Pouch 1080NS, 77 IN x 70 IN,
aperture 4 1/2 IN x 3 1/2 IN, 30/CS**

3M ID 7000053702 UPC 00707387560126

Details

Absorbent throughout entire drape
Resistant to Strikethrough
Fluid Control Features

Typical properties

Brands: Steri-Drape™
Factory ISO Certification: No ISO Certification information available
Product Type: Gynecology Drape
Product Use: Gynecology

Dimensions and Classifications

Overall Length (Metric): 179 cm
Overall Width (Metric): 195 cm

3M™ Bair Hugger™ Warming Blanket, 30500

3M ID B00042287

Details

Facilitates maximum thermal transfer with a blanket that hugs the patient
Soft, comfortable, lightweight, latex-free material
Integrated tuck flaps at the shoulders help maintain blanket position
Foot drape minimizes risk of thermal injury to the feet

Typical properties

Brands: Bair Hugger™
eClass 14 Classification Group: 34540392

3M™ Bair Hugger™ Warming Blanket, 400xx

Details

Single-use over-the-body forced-air warming blanket with excellent heat transfer
Consists of a soft, comfortable, lightweight, material with natural dry rubber latex
not present as a material of construction
Integrated tuck flaps at the shoulders help m

Typical properties

Application: Medical
Blanket Type: Full Body
Brands: Bair Hugger™
Clinical Area: PACU
Factory ISO Certification: No ISO Certification information available
Product Type: Blanket
Quantity: 10 Case
Total Units per Case: 10 per Case
eClass 14 Classification Group: 34540392

Dimensions and Classifications

Overall Length (Imperial): 84 in
Overall Length (Metric): 213 cm
Overall Width (Imperial): 36 in
Overall Width (Metric): 91 cm

3M™ Bair Hugger™ Warming Blanket 52500, Lower Body, 10/Case

3M ID 7100212572 UPC 50707387790092

Details

Single-use lower-body forced-air warming blanket with excellent heat transfer
Consists of a soft, comfortable, lightweight material
Helps maintain normothermia, which can reduce the rate of complications,
including surgical site infection (SSI)(1,2)
Ef

Typical properties

Application: Medical
Blanket Type: Lower Body
Brands: Bair Hugger™
Clinical Area: OR
Factory ISO Certification: No ISO Certification information available
Product Type: Blanket
Quantity: 10 Case
Total Units per Case: 10 per Case
Units per Pack: 10
eClass 14 Classification Group: 34540392

Dimensions and Classifications

Overall Length (Imperial): 60 in
Overall Length (Metric): 152 cm
Overall Width (Imperial): 36 in
Overall Width (Metric): 91 cm

3M™ Attest™ Super Rapid Steam Biological Indicator Challenge Pack, 1496V

Details

Pre-assembled, easy to use steam challenge pack includes a 3M™ Attest™ Super Rapid Readout Steam Biological Indicator, 1492V, Brown Cap, 24 minute Results in just 24 minutes
Monitors 270°F/132°C to 275°F/135°C dynamic-air-removal steam sterilization cyc

Typical properties

Biological Indicator System: Super Rapid
Brands: Attest™
Cap Color: Brown
Catalog Number: 1496VF, 1496V
Factory ISO Certification: No ISO Certification information available
Incubation Period: 24 Minute
Inner Packs per Case: 24 Sets per Case
Product Color: White
Product Type: Challenge Pack
Product Use: Load Monitoring
Sterilization Method: Steam
Total Units per Case: 24 per Case
eClass 14 Classification Group: 34410601

3M™ Tegaderm™ Hydrogel Wound Filler

Details

Preservative-free
Easy to apply
Available in convenient 15 and 25 gram sizes

Typical properties

Brands: Tegaderm™
Cladimed Code: F51BD
Condition: Pressure Ulcer, Wound Care
Department: EMERGENCY, Home Care, Intensive Care Unit, Long-Term Care, Medical-Surgical, Operating Room-Surgery, Urgent Care, Wound Care
Factory ISO Certification: No ISO Certification information available
Hypoallergenic: No
Latex: No
Net Weight (Imperial): 0.033 lb, 0.055 lb
Net Weight (Metric): 15 g, 25 g
Product Type: Hydrogel Wound Filler
Sterile: Yes
Therapeutic Area and Conditions: Dry to Minimally Draining Dermal Ulcers: Arterial, Diabetic, Wounds with Eschar or Slough Requiring Autolytic Debridement
Units per Pack: 10
Volume (Metric): 15 mL, 25 mL

3M™ Ultra Detail Plus Veterinary X-ray Film (Green sensitive), 14" x 17"

3M ID 70200730433 UPC 30051115053031

Details

- Minimizes Effects Of Patient Motion
- Reduces Unnecessary Radiation Exposure
- Extends X-Ray Tube Life
- Can Be Used With Portable Machines
- Increased Diagnostic Ability
- Fewer Retakes Needed
- Saves Time And Money
- Reduce Staff And Patient Exposure
- No Speci

Typical properties

- Brands: 3M™
- Factory ISO Certification: No ISO Certification information available
- Package Contents: 100 Sheets
- Product Type: X-Ray Film
- eClass 14 Classification Group: 34260500

3M™ Ultra Detail Plus Veterinary X-ray Film (Green sensitive), 11" x 14"

3M ID 70200730425 UPC 30051115053024

Details

- Minimizes Effects Of Patient Motion
- Reduces Unnecessary Radiation Exposure
- Extends X-Ray Tube Life
- Can Be Used With Portable Machines
- Increased Diagnostic Ability
- Fewer Retakes Needed
- Saves Time And Money
- Reduce Staff And Patient Exposure
- No Speci

Typical properties

- Brands: 3M™
- Factory ISO Certification: No ISO Certification information available
- Package Contents: 100 Sheets
- Product Type: X-Ray Film
- eClass 14 Classification Group: 34260500

3M™ Ultra Detail Plus Veterinary X-ray Film (Green sensitive), 10" x 12"

3M ID 70200730417 UPC 30051115053017

Details

- Minimizes Effects Of Patient Motion
- Reduces Unnecessary Radiation Exposure
- Extends X-Ray Tube Life
- Can Be Used With Portable Machines
- Increased Diagnostic Ability
- Fewer Retakes Needed
- Saves Time And Money
- Reduce Staff And Patient Exposure
- No Speci

Typical properties

- Brands: 3M™
- Factory ISO Certification: No ISO Certification information available
- Package Contents: 100 Sheets
- Product Type: X-Ray Film
- eClass 14 Classification Group: 34260500

3M™ Ultra Detail Plus Veterinary X-ray Film (Green sensitive), 8" x 10"

3M ID 70200730409 UPC 30051115053000

Details

- Minimizes Effects Of Patient Motion
- Reduces Unnecessary Radiation Exposure
- Extends X-Ray Tube Life
- Can Be Used With Portable Machines
- Increased Diagnostic Ability
- Fewer Retakes Needed
- Saves Time And Money
- Reduce Staff And Patient Exposure
- No Speci

Typical properties

- Brands: 3M™
- Factory ISO Certification: No ISO Certification information available
- Package Contents: 100 Sheets
- Product Type: X-Ray Film
- eClass 14 Classification Group: 34260500

3M™ Steri-Drape™ ENT Surgical Pack, 8 per Carton / 2 Cartons per Case, 9007

3M ID 7000053565 UPC 50707387455984

Details

2 9099 OP Tapes, 4 Hand Towels, 1 9035 Mayo Stand Cover, 1 9069 Drape Sheet, 1 9044 Adhesive Split Sheet, 1 9086 Adhesive Towel Drape, 1 Back Table Cover

Resistant to Strikethrough

Fluid Control Features

Fluid Control Features

Typical properties

Additional Drapes: Pack

Brands: Steri-Drape™

Cladimed Code: E51AD02

Factory ISO Certification: No ISO Certification information available

Product Color: Blue

Product Type: Surgical Pack

Product Use: EENT

Units per Pack: 8

3M™ CoTran™ Ethylene Vinyl Acetate Membrane, 9728, Config Roll

3M ID 7100000167

Details

18.5% Vinyl Acetate
Translucent
Printable
Corona treated on both sides
Matte finish on both sides
Can be directly laminated to adhesives
Heat Sealable (18.5% EVA)

Typical properties

Backing (Carrier) Material: Ethylene Vinyl Acetate
Brands: CoTran™
Caliper: 2 mils
Caliper (Metric): 50.8 µm
Catalog Number: 9728
Elongation CD: 600%
Elongation MD: 600%
Factory ISO Certification: No ISO Certification information available
Heat Seal Layer: Ethylene Vinyl Acetate (EVA)
MVTR (g/m²/24 hr): 97.2
Oxygen Transmission (cc/m²/24hr): N/T
Product Color: Transparent
Product Type: Transdermal Backing
Sample Roll: 6 in x 25 yds
Sample Roll (Metric): 15 cm x 23 m
Tensile CD: 2 lbs/in
Tensile CD (Metric): 1200 g/25 mm
Tensile MD: 4.4 lbs/in
Tensile MD (Metric): 2200 g/25 mm
eClass 14 Classification Group: 41011103

Dimensions and Classifications

Overall Length (Imperial): 1312.34 yd
Overall Length (Metric): 1200 m
Overall Thickness (Imperial): 2 mil
Overall Thickness (Metric): 50.8 micron
Overall Width (Imperial): 48.031 in
Overall Width (Metric): 122 cm

3M™ Synthetic Cast Padding

Details

Spun Dacron polyester padding provides protection and patient comfort, while helping reduce water retention for a drier cast
Strong and durable padding is easy to tear
Conforms easily to body contours
Porous to allow the skin to breathe
Versatile padd

Typical properties

Brands: 3M™
Factory ISO Certification: No ISO Certification information available
Model: CMW02, CMW03, CMW04, CMW06
Product Type: Cast Padding
Product Use: Accessory
Waterproof: No
eClass 14 Classification Group: 34200301

Dimensions and Classifications

Overall Length (Imperial): 4 yd
Overall Length (Metric): 3.658 m
Overall Width (Imperial): 2 in, 3 in, 4 in, 6 in
Overall Width (Metric): 50.8 mm, 76.2 mm, 101.6 mm, 152.4 mm

3M™ Tegaderm™ Diamond Pattern Film Dressing

Details

Balances breathability with effective adhesion for hot, humid conditions or diaphoretic patients
Provides a waterproof, sterile barrier to external contaminants including liquids, bacteria and viruses
Transparent dressing allows for continuous visibility

Typical properties

Brands: Tegaderm™
Cladimed Code: F51CA07
Clinical Sub-Area: Orthopedics
Condition: Dressing & Device Securement, I.V. Related, Pressure Ulcer, Skin Care, Wound Care
Department: Cardiovascular, Dialysis Center, EMERGENCY, I.V. Therapy, Intensive Care Unit, Medical-Surgical, Oncology, Operating Room-Surgery, Pediatrics, Radiology, Urgent Care, Wound Care
Dressing Type: Film
Dressing and Device Securement Condition Type: Adhesive Trauma, Skin Injuries-Mechanical, Tube & Device Securement-Lightweight Tubes & Devices
Factory ISO Certification: No ISO Certification information available
Hypoallergenic: Yes
IV Related Condition Type: Arterial Catheter, CVC Dialysis, CVC Implanted Port, CVC PICC, CVC Short-Term, CVC Tunneled, Epidural Catheter, PIV
Latex: No
Product Type: Standard Dressing
Therapeutic Area and Conditions: Autolytic Debridement, Partial Thickness Wounds, Pressure Ulcer, Secondary Dressing, Surgical Incisions
Waterproof: Yes
eClass 14 Classification Group: 34180304

Dimensions and Classifications

Overall Length (Imperial): 2.75 in, 4.5 in, 4.75 in
Overall Length (Metric): 7 cm, 11.5 cm, 12 cm
Overall Width (Imperial): 2.375 in, 4 in
Overall Width (Metric): 7 cm, 10 cm, 10.16 cm

3M™ Coban™ 2 Two-Layer Compression System

Details

Comfortable – Provides sustained therapeutic compression for up to 7 days
Stays in place – Clinically proven to significantly reduce slippage, to encourage longer wear
Provides consistent compression – The compression layer is designed to be applied at

Typical properties

Boxes per Case: 8.0
Brands: Coban™
Catalog Number: 2092,2094N,20096,2094XL
Comfort Layer Length (Imperial): 1.3 yd, 2.9 yd, 3.8 yd
Comfort Layer Length (Metric): 1.2 m, 2.7 m, 3.5 m
Comfort Layer Width (Imperial): 2 in, 4 in, 6 in
Comfort Layer Width (Metric): 5 cm, 10 cm, 15 cm
Compression Level: Standard
Condition: Wound Care
Department: Home Care, Long-Term Care, Wound Care
Factory ISO Certification: No ISO Certification information available
Features: Extra Long, With Stocking
Hypoallergenic: Yes
Inner Packs per Case: 4 Cartons per Case, 8 Cartons per Case
Latex: No
Product Type: Compression Therapy, Compression Wrap
Total Units per Case: 8 per Case
Units per Inner Pack: 1 per Carton, 2 per Carton
Units per Pack: 1 , 2
Wound Care Condition Type: Venous Leg Ulcer
eClass 14 Classification Group: 34190302

Dimensions and Classifications

Compression Layer Length (Imperial): 3 yd, 4.9 yd, 5.1 yd, 6.3 yd
Compression Layer Length (Metric): 2.7 m, 4.5 m, 4.7 m, 5.8 m
Compression Layer Width (Imperial): 2 in, 4 in, 6 in
Compression Layer Width (Metric): 5 cm, 10 cm, 15 cm
Overall Length (l

3M™ Tegaderm™ I.V. Transparent Film Dressing with Adhesive-Free Window, 1668, 4-3/4 in x 4-3/4 in, 25/ct 4ct/Case

3M ID 7100058058 UPC 50707387770384

Details

Antimicrobial protection – Integrated CHG gel pad provides immediate and continuous antimicrobial protection

Stays in place – CHG gel pad conforms around the needle and stays in contact with skin

Easy to remove – Adhesive-free window minimizes adhesive

Typical properties

Brands: Tegaderm™

Cladimed Code: E52EC1

Condition: I.V. Related

Dressing Type: Film

Factory ISO Certification: No ISO Certification information available

IV Related Condition Type: CVC Implanted Port

Latex: No

Product Type: Standard Dressing

eClass 14 Classification Group: 34180304

Dimensions and Classifications

Overall Length (Imperial): 4.75 in

Overall Length (Metric): 12 cm

Overall Width (Imperial): 4.75 in

Overall Width (Metric): 12 cm

KERRAFOAM™ Gentle Border Foam Dressing

Details

Foam dressing with gentle silicone adhesive and intelligent fluid management
Long wear time

Typical properties

Adhesive: Yes

Adhesive Type: Silicone

Body Part: Sacrum

Border: Yes

Brands: Kerrafoam™

Catalog Number:

CWL1013,CWL1134,CWL1023,CWL1133,CWL1012,CWL1135,CWL1011,CWL1010,CWL1040

Factory ISO Certification: No ISO Certification information available

HCPCS Code: A6212, A6213

Shape: Oval, Sacrum

Units per Inner Pack: 5 per Carton, 10 per Carton

Units per Pack: 5 , 10

eClass 14 Classification Group: 34210409

Dimensions and Classifications

Overall Length (Imperial): 3 in, 4 in, 5 in, 7 in, 8 in, 10 in, 12 in

Overall Length (Metric): 7.5 cm, 10 cm, 12.5 cm, 17.5 cm, 20 cm, 21 cm, 25 cm, 26 cm, 30 cm

Overall Width (Imperial): 3 in, 4 in, 5 in, 7 in, 9 in

Overall Width (Metric): 7.6 cm, 10

3M™ Nu-Derm™ Standard Hydrocolloid Dressing

3M ID B5005265090

Details

Help maintains a moist wound healing environment encouraging autolytic debridement enabling granulation to proceed under optimum conditions
Designed to protect low risk wounds against outside bacterial contamination
Dressings are waterproof and can rema

Typical properties

Brands: Nu-Derm™
eClass 14 Classification Group: 34210405

PREVENA DUO™ with PEEL & PLACE™ Dressing, PRE1121US, 13 cm/13 cm, 5 Kits/Case

3M ID 7100237226

Details

Designed for use on two linear incisions up to 13 cm in length
Provides pre-set, continuous NPWT at -125mmHg
Disposable, single patient use device with 3 AA batteries pre-installed - (Weight 0.4 lbs/0.2 Kg; Dimensions 13.6 x 7.5 x 3 cm)
Replaceable 45

Typical properties

Brands: Prevena™
Factory ISO Certification: No ISO Certification information available

Dimensions and Classifications

Overall Length (Imperial): 5.118 in
Overall Length (Metric): 13 cm
Overall Width (Imperial): 5.118 in
Overall Width (Metric): 13 cm

3M™ Snap™ Advanced Dressing Kit

Details

For use with the 3M™ Snap™ Therapy Cartridge, a disposable negative pressure wound therapy system
Customizable and flexible dressings to address challenging anatomical wounds
Simple and fast application time, under 10 minutes
Hydrocolloids

Typical properties

Brands: Snap™
Catalog Number: SKTF14X34
Factory ISO Certification: No ISO Certification information available
Product Type: Foam Only
eClass 14 Classification Group: 34210701

Dimensions and Classifications

Overall Length (Metric): 10 cm, 15 cm, 20 cm
Overall Width (Metric): 10 cm, 15 cm, 20 cm

3M™ V.A.C.® Granufoam™ Bridge XG Dressing

3M ID B5005265139

Details

Concomitant therapies provide benefits of off-loading and 3M™ V.A.C.® Therapy Helps improve mobility, allowing patients to resume activities of daily living
The 3M™ V.A.C.® Granufoam™ Bridge XG Dressing Kit contains: 2 spiral 3M™ V.A.C.® Granufoam™ Dres

Typical properties

Brands: V.A.C.®

Factory ISO Certification: No ISO Certification information available

eClass 14 Classification Group: 34210701

KERRAPRO™ Pressure Reducing Pad

Details

Indicated for the prevention of pressure ulcers in at-risk patients as part of a pressure ulcer prevention programme
Available in a range of shapes and sizes

Typical properties

Brands: Kerrapro™

Factory ISO Certification: No ISO Certification information available

Shape: Heel, Sacrum/Ankle

Dimensions and Classifications

Overall Length (Metric): 2.5 cm, 5 cm, 10 cm

Overall Thickness (Metric): 0.3 cm, 1.2 cm

Overall Width (Metric): 10 cm, 30 cm, 50 cm

3M™ Snap™ Plus Therapy Strap

3M ID B5005265163

Details

Wear the device discreetly under clothes
For use with the 3M™ Snap™ Plus Therapy Cartridge

Typical properties

Brands: Snap™
Factory ISO Certification: No ISO Certification information available
Product Color: Black
Size: Large, Medium
eClass 14 Classification Group: 34210701

Dimensions and Classifications

Overall Length (Imperial): 21 in, 24 in
Overall Length (Metric): 53 cm, 61 cm

V.A.C. Canister, 500ml with Gel

3M ID B5005265177

Details

Sterile V.A.C. Canister with Gel for 3M™ V.A.C.® Ultra and 3M™ V.A.C.® RX4 Therapy Systems
V.A.C. Canisters feature 3M™ SensaT.R.A.C.™ Tubing
Two sizes available: 500 mL and 1,000 mL
Available in cases of 5 and 10
Package Contents: 1 canister (sterile)

Typical properties

Brands: V.A.C.®
Factory ISO Certification: No ISO Certification information available
Volume (Imperial): 16.907 fl oz
Volume (Metric): 500 mL, 1000 mL
eClass 14 Classification Group: 34210701

Prevena Plus™ Therapy Unit - 14 Day, PRE4010, 1 Kit

3M ID 7100246842

Details

The 3M™ Prevena™ Plus 125 Therapy Unit provides pre-set, continuous NPWT at -125mmHg up to 14 days

The 3M™ Prevena™ Plus 125 Therapy Unit is a disposable, single patient use device with a rechargeable battery (Weight 0.64 lbs/0.29 Kg; Dimensions 16.3 x 8

Typical properties

Brands: Prevena™

Factory ISO Certification: No ISO Certification information available

Product Type: 14-day Pump

3M™ Littmann® Cardiology IV™ Diagnostic Stethoscope

Details

Diagnose and make decisions with confidence
Detect normal and abnormal sounds and rhythms
Useful in critical care and challenging environments such as the ED, ICU, Cardiac ICU, step-down unit and other dynamic locations
7-year warranty
Ergonomic and h

Typical properties

Application: Cardiology/High Performance, Diagnostic Auscultation, Patient Monitoring, Physical Assessment and Blood Pressure, Physical Assessment and Diagnosis

Approved Environmental Marketing Claim (EMC): 3M™ Littmann® next-generation tubing is not made with natural rubber latex, and does not contain phthalate plasticizers.,3M™ Littmann® tubing does not contain phthalate plasticizers. It improves resistance to skin oils and alcohol, and is less likely to pick up stains.,3M™ Littmann® tubing does not contain phthalate plasticizers. It provides longer stethoscope life due to improved resistance to skin oils and alcohol, and is less likely to pick up stains.

Binaural Construction: Double Lumen

Brands: Littmann®

Chestpiece Color: Black, Champagne, High Polish Mirror, Rainbow, Silver, Smoke

Chestpiece Finish: High Polish, Machined Stainless Steel, Matte, Mirror

Chestpiece Size: 1.3 Inch / 3.3 cm, 1.7 Inch / 4.3 cm

Chestpiece Technology: Double-sided

Chestpiece Weight: 3.1 Ounce

Chestpiece Weight (Metric): 87 g

Cladimed Code: K50BE01

Diaphragm Diameter (Imperial): 1.7 in

Diaphragm Diameter (Metric): 4.3 cm, 4.3 mil

Diaphragm Material: Epoxy/Fiberglass

Diaphragm Shape: Round

Diaphragm Type: Tunable, single-piece

Eartip Type: Soft Sealing

Environmental claim being made: Yes

Environmental claim relates to: Product

Evidence for Claim: Self Certified

Extra Eartips: Yes

Factory ISO Certification: No ISO Certification information available

Headset Finish: Black, Smoke, Stainless

Headset Material: Anodized Aluminum

Model: Cardiology IV™

Net Weight (Imperial): 0.39 lb, 6.2 oz

Net Weight (Metric): 177 g

Occupation: Advanced Registered Practice Nurse, Anesthesiologist, Cardiologist, Critical Care Nurse, EMT/EMS, Emergency Physician, Family Practitioner,

Gastroenterologist, Hospitalist, Intensivist, Internist, Medical Student, Nurse, Nursing Student, Obstetrician, Osteopath, Pediatrician, Physician, Physician Assistant, Pulmonologist, Respiratory Specialist, Teacher/Professor/Instructor, Veterinarian

Performance: 9

Product Type: Stethoscope

Small Diaphragm Diameter: 1.3 in

Small Diaphragm Diameter (Metric): 3.3 cm, 3.3 mil

Special Adaptors: No

Tube Color: Alabaster, Black, Burgundy, Caribbean Blue, Gray, Hunter Green, Midnight Blue, Navy Blue, Plum, Raspberry, Red, Rose Pink

Tube Construction: Double Lumen

Tunable Diaphragm: Yes

Warranty Period: 7 yr

eClass 14 Classification Group: 34340191

Dimensions and Classifications

Overall Diameter (Imperial): 1.7 in

Overall Diameter (Metric): 4.3 cm

Overall Length (Imperial): 22 in, 27 in

Overall Length (Metric): 55.8 cm, 69 cm

3M™ Medical Tape, 4576, Polyester Spunlace Nonwoven Extended Wear, 60# Liner, Configurable

3M ID 7100274476

Details

- Extended wear medical and retail applications
- Biocompatible for Use on Intact Skin
- Conformable
- Comfortable during wear
- Secure adhesion to low surface energy surfaces

Typical properties

- Adhesive Type: Acrylic
- Backing (Carrier) Material: Polyester Spunlace
- Brands: 3M™
- Breathable: Yes
- Conformability: Medium
- Factory ISO Certification: No ISO Certification information available
- Liner Material: Paper
- Printable Backing: Yes
- Product Usage: Adhesion to Skin
- Tape Type: Single Sided Spunlace Nonwoven Tape
- eClass 14 Classification Group: 34180201

3M™ Steri-Drape™ Minor Procedure Drape 1092NS, 500/CS

3M ID 7000053750 UPC 00707387023454

Details

Resistant to Strikethrough
Reliable, dependable adhesive
Fluid Control Features
Remove, duplicate

Typical properties

Brands: Steri-Drape™
Factory ISO Certification: No ISO Certification information available
Product Type: Aperture Drape
Product Use: Surgical Sheet

Dimensions and Classifications

Overall Length (Metric): 64 cm
Overall Width (Metric): 56 cm

3M™ Microfluidic Diagnostic Tape 9795WT, Silicone Adhesive on White PET Tape, 7 mil, Configurable

3M ID 7100241046

Details

Delayed tack adhesive
Thick backing reduces deformation
Nonhemolytic
Non-toxic to mammalian cells

Typical properties

Brands: 3M™
Factory ISO Certification: No ISO Certification information available
eClass 14 Classification Group: 34180101

3M™ Steri-Drape™ Femoral Angiography Drape 1191

3M ID 7000002635 UPC 50707387229110

Details

Resistant to Strikethrough
Reliable, secure adhesive

Typical properties

Brands: Steri-Drape™
Cladimed Code: E51BF01
Factory ISO Certification: No ISO Certification information available
Loophole Length (Metric): 6 cm
Loophole Width (Metric): 9 cm
Material: Fabric
Model: 1191
Procedure: Cardiovascular
Product Type: Angiography Drape
Product Type Free Format: Drape
Product Use: Cardiovascular
Therapeutic Area and Conditions: Angiography
Units per Pack: 20

Dimensions and Classifications

Overall Length (Imperial): 90 in
Overall Length (Metric): 228 cm
Overall Width (Imperial): 130 in
Overall Width (Metric): 330 cm

3M™ Steri-Drape™ Femoral Angiography Drape, 20 per Case, 1191NS

3M ID 7000053745 UPC 00707387565732

Details

Incise film adheres to the surgical site to provide a sterile surface at the beginning of surgery
Reliable, dependable adhesive
Fluid Control Features
Resistant to Strikethrough

Typical properties

Brands: Steri-Drape™
Factory ISO Certification: No ISO Certification information available
Product Type: Angiography Drape
Product Use: Cardiovascular

Dimensions and Classifications

Overall Length (Metric): 228 cm
Overall Width (Metric): 182 cm

3M™ Cavilon™ Moisturizing Hand Lotion 9205

3M ID 7000002979 UPC 50707387505528

Details

CHG Compatible – Can be used with chlorhexidine gluconate (CHG) and will not break down latex gloves

Skin Friendly, Everyday Moisturizer– Hypoallergenic and fragrance-free to be easy on sensitive skin

Hypoallergenic

Will not break down latex gloves

Typical properties

Anti-fungal: No

Brands: Cavilon™

Condition: Skin Care

Container Volume: 16 Ounce

Delivery System: Bottle

Department: Cardiovascular, Critical Care, Dialysis Center, EMERGENCY, Intensive Care Unit, Labor & Delivery, Medical-Surgical, Oncology, Orthopedics, Pediatrics, Radiology, Urgent Care, Wound Care

Factory ISO Certification: No ISO Certification information available

Hypoallergenic: Yes

Latex: No

Moisturizing: Yes

Product Type: Skin Care

Volume (Imperial): 16 fl oz

Volume (Metric): 473 mL

eClass 14 Classification Group: 40290501

3M™ Bair Hugger™ Warming Blanket 31000, Pediatric, 10/Case

3M ID 7100212566 UPC 50707387790061

Details

Facilitates maximum thermal transfer with a blanket that hugs the patient
Soft, comfortable, lightweight, latex-free material
Integrated tuck flaps at the shoulders help maintain blanket position
Foot drape minimizes risk of thermal injury to the feet

Typical properties

Application: Medical
Blanket Type: Full Body
Brands: Bair Hugger™
Cladimed Code: Non applicable
Clinical Area: PACU, Pediatric
Factory ISO Certification: No ISO Certification information available
Product Type: Blanket
Quantity: 10 Case
Total Units per Case: 10 per Case
Units per Pack: 10
eClass 14 Classification Group: 34540392

Dimensions and Classifications

Overall Length (Imperial): 60 in
Overall Length (Metric): 152 cm
Overall Width (Imperial): 36 in
Overall Width (Metric): 91 cm

3M™ Bair Hugger™ Warming Blanket 63500, Full Access Underbody, 5/Case

3M ID 7100212587 UPC 50707387790221

Details

Full access underbody forced-air warming blanket warms the patient while providing full, unrestricted patient access
One clear plastic drape (included) helps retain warm air around the head of the patient
Constructed of soft, radiolucent materials
Perf

Typical properties

Application: Medical
Blanket Type: Underbody
Brands: Bair Hugger™
Cladimed Code: Non applicable
Clinical Area: Cardiac & Specialty, OR, Underbody
Drape Length: 24 in
Drape Length (Metric): 61 cm
Drape Width: 48 in
Drape Width (Metric): 122 cm
Factory ISO Certification: No ISO Certification information available
Product Type: Blanket
Quantity: 5 Case
Total Units per Case: 5 per Case
Units per Pack: 5
eClass 14 Classification Group: 34540392

Dimensions and Classifications

Overall Length (Imperial): 84 in
Overall Length (Metric): 91 cm
Overall Width (Imperial): 36 in
Overall Width (Metric): 221 cm

3M™ Bair Hugger™ Warming Blanket 54500, Adult Underbody, 10/Case

3M ID 7100212569 UPC 50707387790146

Details

Underbody design warms the patient while providing full, unrestricted patient access

Constructed of soft, radiolucent materials

Perforated slits allow flexible patient positioning and the use of a drawsheet

Fluid outlets minimize pooling of fluids on t

Typical properties

Application: Medical

Blanket Type: Underbody

Brands: Bair Hugger™

Cladimed Code: Non applicable

Clinical Area: Cardiac & Specialty, OR, Underbody

Factory ISO Certification: No ISO Certification information available

Product Type: Blanket

Quantity: 10 Case

Total Units per Case: 10 per Case

Units per Pack: 10

eClass 14 Classification Group: 34540392

Dimensions and Classifications

Overall Length (Imperial): 74 in

Overall Length (Metric): 188 cm

Overall Width (Imperial): 36 in

Overall Width (Metric): 91 cm

3M™ CoTran™ Ethylene Vinyl Acetate Membrane Film, 9702, Config Roll

3M ID 7100000164

Details

9% Vinyl Acetate
Translucent
Printable
Not corona treated
Matte finish on one side
Can be directly laminated to adhesives
Heat Sealable (9% EVA)

Typical properties

Backing (Carrier) Material: Ethylene Vinyl Acetate
Brands: CoTran™
Caliper: 2 mils
Caliper (Metric): 50.8 µm
Catalog Number: 9702
Elongation CD: 300%
Elongation MD: 200%
Factory ISO Certification: No ISO Certification information available
Heat Seal Layer: Ethylene Vinyl Acetate (EVA)
MVTR (g/m²/24 hr): 52.8
Oxygen Transmission (cc/m²/24hr): N/T
Product Color: Transparent
Product Type: Transdermal Membrane
Sample Roll: 6 in x 25 yds
Sample Roll (Metric): 15 cm x 23 m
Tensile CD: 2 lbs/in
Tensile CD (Metric): 900 g/25 mm
Tensile MD: 4.4 lbs/in
Tensile MD (Metric): 2000 g/25 mm
eClass 14 Classification Group: 41011103

Dimensions and Classifications

Overall Length (Imperial): 1312.34 yd
Overall Length (Metric): 1200 m
Overall Thickness (Imperial): 2 mil
Overall Thickness (Metric): 50.8 micron
Overall Width (Imperial): 48.031 in
Overall Width (Metric): 122 cm

3M™ Attest™ Lead Free Steam Indicator Tape

Details

Not made with Natural Rubber Latex
Trusted, high quality adhesive
Lead Free Ink means no hazardous waste issues
Stretchable backing that minimizes tape "pop-off" during sterilization
Can be written on or labeled with pre-printed labels

Typical properties

Brands: Attest™
Cladimed Code: E52IA01
Factory ISO Certification: No ISO Certification information available
Life Science Sterilization: Sterilization Indicator Tapes & Dispensers
Model: 1322-12MM, 1322-18MM, 1322-24MM, 1355-24MMSC
Product Color: Beige
Product Type: Indicator Tape
Product Use: Exposure Monitoring
Sterilization Method: Steam
Units per Pack: 20 , 28 , 42
eClass 14 Classification Group: 34410301

Dimensions and Classifications

Overall Length (Imperial): 60 yd
Overall Length (Metric): 55 m
Overall Width (Imperial): 0.5 in, 0.709 in, 1 in
Overall Width (Metric): 12 mm, 18 mm, 24 mm

3M™ Veraflo™ Cleanse Choice Complete™ Dressing

3M ID B5005351004

Details

Ideal for wounds with thick fibrinous exudate, slough, necrotic tissue, infectious material or other wound bioburden
Reduces the number of surgical debridements required
Convenient single piece of blue foam for a quick product identification
One side d

Typical properties

Brands: Veraflo™
Factory ISO Certification: No ISO Certification information available
Size: Large, Medium, X-Large
Units per Pack: 5
eClass 14 Classification Group: 34210701

3M™ CoTran™ Polyethylene Tape, 9693, Config Roll

3M ID 7100082650

Details

Tan
Breathable
Conformable
Pressure sensitive acrylate adhesive

Typical properties

Brands: CoTran™
Caliper: 5 mils
Caliper (Metric): 127 µm
Factory ISO Certification: No ISO Certification information available
Liner Caliper (Metric): 120 µm
Liner Caliper (mils): 4.9 mil
Liner Release: ≤50 g/in
Liner Release (Metric): ≤0.5 N/25.4 mm/in
Product Color: Tan
Sample Roll: 6 in x 25 yds
Sample Roll (Metric): 15 cm x 23 m
Tape Total Caliper: 9.9 mil
Tape Total Caliper (Metric): 247.0 µm
eClass 14 Classification Group: 34180101

Dimensions and Classifications

Overall Length (Imperial): 500 yd
Overall Length (Metric): 457 m
Overall Width (Imperial): 48 in
Overall Width (Metric): 121.92 cm

3M™ Medipore™ Dress-It Pre-Cut Dressing Covers, 2950 Series

Details

Available in pre-cut pads
Easy to use
Breathable and flexible to maintain skin integrity
Hypoallergenic and not made with natural rubber latex

Typical properties

Brands: Medipore™
Department: Cardiovascular, Critical Care, Dialysis Center, EMERGENCY, I.V. Therapy, Intensive Care Unit, Labor & Delivery, Medical-Surgical, Oncology, Operating Room-Surgery, Orthopedics, Pediatrics, Radiology, Urgent Care, Wound Care
Factory ISO Certification: No ISO Certification information available
Hypoallergenic: Yes
Latex: No
Material: Soft Cloth
Product Color: White
Product Type: Composite
Units per Pack: 25
eClass 14 Classification Group: 34180201

Dimensions and Classifications

Overall Length (Imperial): 4.675 in, 5.875 in, 7.875 in, 11 in
Overall Length (Metric): 12 cm, 15 cm, 20 cm, 28 cm
Overall Width (Imperial): 3.937 in, 5.875 in, 7.874 in
Overall Width (Metric): 10 cm, 15 cm, 20 cm

3M™ Ranger™ Blood/Fluid Warming Set, 24000 Series

Details

Disposable set slides easily into the warming unit and only fits in one direction, making set up hassle-free

Easy-to-use

Cost effective

Latex-free

Typical properties

Approved Environmental Marketing Claim (EMC): Not made with DEHP

Brands: Ranger™

Cladimed Code: Non applicable

Clinical Area: OR

Compatible Outlet: EU

Contents: Heat exchanger, bubble trap, air aspiration port, fluid aspiration port, 24 inch patient line, Heat exchanger, bubble trap, needleless IV injection port, 30 inch patient line, Heat exchanger, bubble trap, needle IV injection port, 30 inch patient line

Environmental claim being made: Yes

Environmental claim relates to: Product

Factory ISO Certification: No ISO Certification information available

Flow Rate (Imperial): 0.04 GPM

Fluid Type: Blood/Fluid

Model: 24200, 24250, 24450

Pressure Infusion: Up to 300 mmHg maximum dynamic operating pressure

Priming Volume: 20 mL, 39 mL, 44 mL

Product Type: Disposable Set, Warming Unit

Quantity: 10 Case

Set Type: Pediatric, Standard Flow/Routine

Sterile: Ethylene Oxide (EO)

Units per Pack: 10

eClass 14 Classification Group: 34540392

3M™ Transpore™ White Surgical Tape, 1534/1544 Series

Details

Gentle to skin
Easy, straight bi-directional tear
Breathable to maintain skin integrity
Good initial and long-term adhesion (72 hours)
Easy to handle with gloves
Hypoallergenic and not made with natural rubber latex
Water resistant
Economical single

Typical properties

Approved Environmental Marketing Claim (EMC): We're proud to offer tapes with solvent-free adhesives: 3M™ Kind Removal Silicone Tape, Transpore™, Transpore™ White and Micropore™.

Brands: Transpore™

Environmental claim being made: Yes

Environmental claim relates to: Product

Evidence for Claim: Self Certified

Factory ISO Certification: No ISO Certification information available

Hypoallergenic: Yes

IV Related Condition Type: Arterial Catheter, CVC Dialysis, CVC Implanted Port, CVC PICC, CVC Short-Term, CVC Tunneled, PICC, PIV

Material: Paper

Product Color: White

Product Type: Medical Tape, Surgical Tape

Therapeutic Area and Conditions: Perforated Surgical Tape

Units per Pack: 24 , 50 , 100

Dimensions and Classifications

Overall Length (Imperial): 1.5 yd, 10 yd

Overall Length (Metric): 1.3 m, 1.37 m, 9.1 cm, 9.1 m

Overall Width (Imperial): 0.5 in, 1 in, 2 in, 3 in, 48 in

Overall Width (Metric): 2.5 cm, 2.54 cm, 5 cm, 5.08 cm, 7.6 cm, 12.5 mm, 121.92 cm

FUTURO™ Arm Sling, 46204ENR, Adult size

3M ID 70007024154 UPC 00051131200920

Details

Provides mild support for sprains and post-surgery recovery
Cradle design takes weight off your arm to help reduce fatigue
Breathable materials allow air to circulate and help keep skin dry
Comfort Pad cushions the shoulder bone and muscles
One-hand,

Typical properties

Body Part: Arm
Brands: FUTURO™
Condition: Sprains
Factory ISO Certification: No ISO Certification information available
Product Color: Gray
Product Type: Sling
Product Use: General Support, Post Cast, Post Surgery, Recovery
Size: One Size Fits Most
Sizes Available: One Size - Adjustable
Support and Compression Level: Mild
Type: Support
eClass 14 Classification Group: 34200201

FUTURO™ Comfort Stabilizing Back Support

3M ID CBGBLW011036 UPC 00051131201552

Details

Firm design offers customizable levels of support and compression
Adjustable straps provide a personalized fit
Helps provide support to a stiff, strained or aching back. Breathable materials enhance airflow to help keep skin dry
Breathable materials en

Typical properties

Body Part: Back
Brands: FUTURO™
Condition: Back Pain, Sprains, Strains
Factory ISO Certification: No ISO Certification information available
Fit Range: S/M fits: 29" to 39"
L/XL fits: 39" to 50"
Material: Acrylic, Fiberboard, Nylon, Polyester, Polyurethane, Spandex
Product Color: Gray
Product Type: Support, Wrap around
Product Use: During Strong Activity, General Support, Lower Back Support, Moderate/Occasional Pain, Post Surgery, Prevention, Recovery, Severe/Chronic back pain, Support for a saggy abdomen
Size: Large/X-Large, Small/Medium
Sizes Available: Large/Extra Large, Small/Medium
Support Level: Moderate
Support and Compression Level: Moderate
Type: Stabilizer
Where to Measure: Measure around waist at navel.
eClass 14 Classification Group: 34200201

FUTURO™ Comfort Knee Support, 76587ENR, Medium

3M ID 70006851870 UPC 00051131200999

Details

Four-way stretch and contoured design conforms to your knee for comfort and mild support
Breathable material for comfort
Flexible fabric promotes a full range of motion
Wear on either knee for versatility
Low profile silhouette fits discreetly under c

Typical properties

Body Part: Knee
Brands: FUTURO™
Condition: Arthritis, Jumper's Knee, Patella Tracking, Pinched Nerve, Runner's Knee, Sprains, Strains, Swelling, Tendonitis
Factory ISO Certification: No ISO Certification information available
Fit Range: MEDIUM fits: 14.5" to 17"
LARGE fits: 17" to 19.5"
Material: Nylon, Polyester, Spandex
Package Contents: 1/pack
Product Color: Gray
Product Type: Support
Product Use: During Strong Activity, General Support, General Support for Athletic Activity, Low Impact Activity, Medial/Lateral Support, Moderate/Occasional Pain, Prevention, Recovery, Weak, Sore Muscles & Injured Knees
Size: Medium
Sizes Available: Medium
Support Level: Mild
Support and Compression Level: Mild
Type: Support
Where to Measure: Measure around kneecap while standing.
eClass 14 Classification Group: 34200201

FUTURO™ Thumb Deluxe Stabilizer

3M ID CBGBLW011060 UPC 00051131198555

Details

Helps aching, sore and weak thumbs with moderate support
Provides stability to your lower thumb joints
Durable lacing system easily adjusts for a snug fit
Ergonomic fit offers great range of motion to remaining fingers
Soft, breathable materials enhance

Typical properties

Body Part: Hand, Thumb

Brands: FUTURO™

Condition: Arthritis, Carpal Tunnel Syndrome, Osteoarthritis, Pinched Nerve, Repetitive Stress Injury, Sprains, Strains, Swelling, Tendonitis, Thumb Hyperextension

Factory ISO Certification: No ISO Certification information available

Fit Range: S/M fits: 5" to 6.5"
L/XL fits: 6.5" to 8"

Material: Acetal Plastic (POM), Nylon, PVC, Polyester, Polyurethane, Rayon, Spandex, Steel

Product Color: Black

Product Type: Brace, Thumb Splint

Product Use: Aching, Weak or Swollen Hand or Wrist, During Strong Activity, General Support for Athletic Activity, Moderate/Occasional Pain, Prevention, Recovery, Repetitive Stress, Repetitive Stress Injury, Sore, Weak or Injured Thumb, Support for Arthritic Joints

Size: Large/X-Large, Small/Medium

Sizes Available: Small / Medium, Large / X-Large

Support Level: Moderate, Moderate-Stabilizing

Support Level Description: Provides fitted and anatomically correct stabilizing support to help relieve symptoms associated with strains, sprains, arthritis, repetitive stress injuries and to help prevent re-injury. Flexible stabilizers may be removable and customizable for comfort. Provides fitted and anatomically correct stabilizing support to help relieve symptoms associated with strains, sprains, arthritis, repetitive stress injuries and to help prevent re-injury. Flexible stabilizers may be removable and customizable for comfort.

Support and Compression Level: Moderate, Moderate-Stabilizing

Type: Brace, Stabilizer

Where to Measure: Measure around the palm of hand above the thumb

eClass 14 Classification Group: 34200201

Nexcare™ Ultra Stretch Adhesive Pad SFP34, 3 in x 4 in

3M ID 70005097632 UPC 00051131197749

Details

Provides protection to minor burns, scrapes, cuts and abrasions
Absorbent pad wicks fluid and doesn't stick to your wound
Water-resistant formula
Strong adhesive stays put for up to four days
Stretchy design moves with you
Breathable design provides

Typical properties

Application: Sensitive Skin
Brands: Nexcare™
Factory ISO Certification: No ISO Certification information available
Package Contents: 4 Pack
Product Color: Tan
Product Type: Pad with Adhesive
Properties: Repositionable
Sizes Available: 4 ct. (Cat# SFP34): Dressing Size: 3" x 4"; Pad Size: 1-9/16" x 2-5/8"
Solution for: For Large Wounds, For places that bend
Wound Type: Cuts / Scrapes / Abrasions, Minor Burns
eClass 14 Classification Group: 34400201

Dimensions and Classifications

Overall Length (Imperial): 4 in
Overall Length (Metric): 101.6 mm
Overall Width (Imperial): 3 in
Overall Width (Metric): 76.2 mm

ACE™ Brand Adjustable Back Brace

3M ID COBBLW014084 UPC 00051131208100

Details

Stabilizing design offers customizable levels of support and comfort
Dual straps provide a customized, personalized fit
Anatomical design allows full range of motion
Breathable back panel allows airflow to help keep skin dry
Smooth binding helps provi

Typical properties

Body Part: Back
Brands: ACE™
Condition: Back Pain
Factory ISO Certification: No ISO Certification information available
Fit Range: Up to 48" waist
Latex-free: No
Material: Natural Rubber Latex, Neoprene, Nylon, Polyester, Polypropylene, Spandex
Performance Zone Category: Return to Activity
Product Color: Black
Product Type: Brace
Product Use: Back Pain, General Soreness, Support for a saggy abdomen
Properties: Adjustable, Breathable, Odor Control
Size: Adjustable
Sizes Available: One Size - Adjustable
Support Level: Moderate
Support Level Description: Provides moderate support and stabilization to help prevent re-injury and relieve symptoms associated with strains, sprains, arthritis and repetitive stress injuries.
Type: Brace
Where to Measure: Measure around waist.
eClass 14 Classification Group: 34200201

ACE™ Knee/Elbow Pads, 908002, One Size

3M ID 70005196533 UPC 00051131209220

Details

Durable design for lasting use
Padded design helps protect you from impact
Stretchy fabric for a snug fit
Great for use during multiple activities
One size fits most
#1 Pharmacist Recommended Brand of Braces & Supports* (*Based on Pharmacy Times and

Typical properties

Body Part: Elbow, Knee
Brands: ACE™
Factory ISO Certification: No ISO Certification information available
Ideal For: Basketball, Football, Hockey, Soccer, Volleyball
Product Color: Black
Product Type: Knee/Elbow Pad
Product Use: Protection
Size: One Size Fits Most
Sizes Available: One Size
Sport: Basketball, Football, Hockey, Soccer, Volleyball
eClass 14 Classification Group: 34200201

ACE™ Brand Night Wrist Sleep Support

3M ID COBBLW014184 UPC 00051131225992

Details

Cushioning beads support ideal neutral hand position during rest
Adjustable palmar splint optimizes wrist support
Easy sleeve slide-on design for effortless application
Breathable, durable and soft
Fits right or left hand
Not made with natural rubber

Typical properties

Body Part: Wrist
Brands: ACE™
Closure Method: Hook & Loop
Condition: Arthritis, Carpal Tunnel Syndrome, Pinched Nerve, Repetitive Stress Injury, Sprains, Strains, Swelling, Tendonitis, Thumb Hyperextension
Factory ISO Certification: No ISO Certification information available
Fit Range: 5.25" to 9"
Package Contents: 1/pack
Product Color: Navy
Product Type: Support
Product Use: During Strong Activity, General Soreness, General Support for Athletic Activity, Moderate/Occasional Pain, Prevention, Recovery, Symptoms of Carpal Tunnel Syndrome
Properties: Breathable
Size: Adjustable
Sizes Available: One Size - Adjustable
Support Level: Moderate
Type: Support
Where to Measure: Measure around wrist at smallest point.
eClass 14 Classification Group: 34200201

ACE™ Brand Moisture Control Knee Support

3M ID COBBLW014197 UPC 00051131197855

Details

Unique blend of materials for strong support, soothing warmth and comfort
Breathable material behind knee releases excess moisture
Open patella design for support and comfort of the kneecap
Two-strap closure for customizable fit and support
Flexible d

Typical properties

Body Part: Knee
Brands: ACE™
Closure Method: Hook & Loop
Condition: Arthritis, Sprains, Strains, Tendonitis
Factory ISO Certification: No ISO Certification information available
Fit Range: MEDIUM fits: 15" to 17"
LARGE fits: 17" to 19"
Latex-free: Yes
Performance Zone Category: Return to Activity
Product Color: Black
Product Type: Support
Product Use: General Soreness, Support for Arthritic Joints, Tendonitis
Properties: Breathable, Non Latex Containing, Odor Control, Reusable
Size: Large, Medium
Sizes Available: Medium, Large
Support Level: Moderate
Type: Support
Where to Measure: Measure around kneecap while standing.
eClass 14 Classification Group: 34200201

ACE™ Reusable Cold/Hot Compress 207518

3M ID 70007019840 UPC 00051131203990

Details

Soft outer pouch is comfortable against your skin
Reuse again and again
Heat therapy is great for muscle aches, cramps, and stiffness
Cold therapy is ideal for sprains, strains, bumps, and bruises
ACE Brand is America's most trusted brand of braces, s

Typical properties

Body Part: Multi-Purpose
Brands: ACE™
Factory ISO Certification: No ISO Certification information available
Injury: Arthritis, Bumps/Bruises, Insect Bites, Muscle Aches/Cramps, Sprains & Strains, Swelling
Performance Zone Category: Injury Care
Product Color: Beige
Product Type: Hot/Cold Therapy
Properties: Comfort Touch
Size: Adjustable
Sizes Available: Adjustable
Type: Hot/Cold Therapy
eClass 14 Classification Group: 34400201

ACE™ Brand Therapeutic Arch Support

3M ID CBGBLWUS1366 UPC 00051131216372

Details

Provide foot, arch and heel support for plantar fasciitis pain
Offers comfortable compression with stretchable, breathable materials
Two removable arch inserts provide customizable support
Low-profile design is compatible with footwear
Breathable mate

Typical properties

Body Part: Foot
Brands: ACE™
Factory ISO Certification: No ISO Certification information available
Fit Range: 8.5" to 12"
Latex-free: Yes
Material: Nylon, Polyester, Polypropylene, Polyurethane, Spandex, Thermoplastic Elastomer (TPE)
Performance Zone Category: Return to Activity
Product Color: Black
Product Type: Support
Properties: Adjustable, Non Latex Containing, Odor Control, Washable
Size: Adjustable
Sizes Available: One Size - Adjustable
Support Level: Moderate
Type: Support
Where to Measure: Measure instep circumference.
eClass 14 Classification Group: 34200201

Nexcare™ Max Hold Waterproof Bandages, Assorted

3M ID CBGBLRUS1509 UPC 00051131216778

Details

Max Hold design stays on until you take it off for up to 48 hours
Comfortable, low-profile film fits close to the skin
Helps waterproof, dirtproof, and germproof your wounds
Contours to hard-to-fit places, like heels, the hand, knees, and fingers
Thin

Typical properties

Application: Waterproof
Brands: Nexcare™
Factory ISO Certification: No ISO Certification information available
Material: Plastic
Package Contents: 40 Pack, 6 Pack, 60 Pack, 15 Pack
Product Color: Transparent
Product Type: Bandage
Properties: Waterproof
Size: Assorted
Sizes Available: 15 ct. Asst: 3 at 1" x 2.81" (25mm x 71mm), 4 at 1.25" x 2.5" (31mm x 63mm), 8 at 1.06" x 2.25" (26mm x 57mm); 40 ct Asst: 8 at .88" x 1.1" (22mm x 27mm), 6 at 1" x 2.81" (25mm x 71mm), 8 at 1.25" x 2.5" (31mm x 63mm), 18 at 1.06" x 2.25" (26mm x 57mm); 60 ct: 1.25" x 2.5" (31mm x 63mm); Knee & Elbow: 2.38" x 3.5" (60mm x 88mm); Heel & Hand: 6 at 1.75" x 2.81" (44mm x 71mm)
Solution for: Heels/Toes, Knees/Elbows, Stays on Longer, Waterproof
Waterproof: Yes
Wound Type: Cuts / Scrapes / Abrasions
eClass 14 Classification Group: 34400201

Dimensions and Classifications

Overall Length (Imperial): 3.5 in
Overall Length (Metric): 88 mm
Overall Width (Imperial): 2.38 in
Overall Width (Metric): 60 mm

Nexcare™ Strong Hold Pain-Free Removal Tape SST-1, 1 in x 4 yd (25,4 mm x 3,65 m)

3M ID 70007040382 UPC 00051131216785

Details

From the #1 leader in U.S. hospital tapes
Pain-free removal
Up to 48 hr hold
Proprietary advanced silicone adhesive
Repositionable for optimal placement
Good for use on infants, children and the elderly
Removes gently from hair
Tears easily in both

Typical properties

Brands: Nexcare™
Factory ISO Certification: No ISO Certification information available
Material: Paper
Package Contents: 1 Pack
Product Color: Blue
Product Type: Tape
Waterproof: No
eClass 14 Classification Group: 34400201

Dimensions and Classifications

Overall Length (Imperial): 4 yd
Overall Length (Metric): 3.65 m
Overall Width (Imperial): 1 in
Overall Width (Metric): 25.4 mm

3M™ Kerracel™ Gelling Fiber Dressing

Details

Conformable¹
Can be used under compression^{2*}
Cuttable¹
Vertical absorption^{2*}
Up to 7 days wear time

Typical properties

Brands: Kerracel™
Factory ISO Certification: No ISO Certification information available
Inner Packs per Case: 10 Cartons per Case
Total Units per Case: 50 per Case, 100 per Case
Units per Inner Pack: 5 per Carton, 10 per Carton
eClass 14 Classification Group: 34210402

Dimensions and Classifications

Overall Length (Imperial): 2 in, 6 in, 18 in
Overall Length (Metric): 5 cm, 15 cm, 45 cm
Overall Width (Imperial): 1 in, 2 in, 6 in
Overall Width (Metric): 2.5 cm, 5 cm, 15 cm

3M™ V.A.C.® Granufoam™ Dressing w/SensaT.R.A.C.™ Pad

3M ID B5005265111

Details

Multiple shapes and sizes to accommodate diverse wounds

3M™ V.A.C.® Granufoam™ Dressings are available in: four sizes (Small/Medium/Large/X-Large), 3M™ V.A.C.® Granufoam™ Round Dressing, 3M™ V.A.C.® Granufoam™ Thin Dressing, and 3M™ V.A.C.® Granufoam™ H

Typical properties

Brands: V.A.C.®

Factory ISO Certification: No ISO Certification information available

Shape: Hand

eClass 14 Classification Group: 34210701

3M™ Prevena Restor™ ArthroForm™ Incision Management System

Details

Available in two dressing options with for use to manage incisions and the surrounding soft tissue (33x30 cm & 46x30cm) for up to 7 days
The 3M™ Prevena™ Plus 125 Extended Therapy Unit provides pre-set, continuous NPWT at -125mmHg up to 14 days with a re

Typical properties

Brands: Prevena Restor™

Factory ISO Certification: No ISO Certification information available

Product Type: 14-day Pump

Dimensions and Classifications

Overall Length (Metric): 30 cm

Overall Width (Metric): 33 cm, 46 cm

3M™ V.A.C.® Whitefoam™ Dressing

3M ID B5005265135

Details

Less adherent material than 3M™ V.A.C.® Granufoam™ Dressings
Pre-moistened with sterile water
Available in Small and Large Dressing sizes as Foam Only or part of a 3M™ V.A.C. Whitefoam™ Dressing Kit (includes dressing and 3M™ SensaT.R.A.C.™ Pad Tubing)

Typical properties

Brands: V.A.C.®
Factory ISO Certification: No ISO Certification information available
Product Type: Foam Only
Size: Large, Small
eClass 14 Classification Group: 34210701

ACTIV.A.C.™ Carrying Case

3M ID B5005265185

Details

Used with the 3M™ ActiV.A.C.™ Therapy System

Typical properties

Brands: ActiV.A.C.™

eClass 14 Classification Group: 34210701

3M™ Nu-Derm™ Border Hydrocolloid Dressing

3M ID B5005265212

Details

Help maintains a moist wound healing environment encouraging autolytic debridement enabling granulation to proceed under optimum conditions
Designed to protect low risk wounds against outside bacterial contamination
Dressings are waterproof and can rema

Typical properties

Brands: Nu-Derm™
eClass 14 Classification Group: 34400201

3M™ Bair Hugger™ Warming Unit Replacement Controller, Model 90082, 1 EA

3M ID 7100087545 UPC 00707387774882

Details

Replaces the 875 model warming unit controller

Typical properties

Brands: Bair Hugger™

Cladimed Code: F59ZZ99

Clinical Area: PACU, Pre-op

Factory ISO Certification: No ISO Certification information available

Hardware: Accessory

Model: 90082

Net Weight (Imperial): 0.2 lb

Net Weight (Metric): 90 g

Product Type: Accessory

Quantity: 1 each

Dimensions and Classifications

Overall Depth (Imperial): 6 in

Overall Depth (Metric): 152 mm

Overall Height (Imperial): 1.5 in

Overall Height (Metric): 3.8 cm

Overall Width (Imperial): 2.5 in

Overall Width (Metric): 6.4 cm

3M™ Steri-Drape™ Pouch with Ioban™ 2 Incise Film, 2057, 87 cm x 74 cm, 10/Case, 4/Case

3M Product Number 2057 3M ID 7000030146 UPC 30707387092871

Details

Incise area adheres securely to skin and immobilizes bacteria
Features a large-capacity 360° fluid collection pouch designed to minimize potential risk of healthcare providers' exposure to blood and body fluids
For C-section surgical procedures and abdo

Typical properties

Accessories: Bags and Pouches
Brands: Steri-Drape™
Cladimed Code: E51CD01
Factory ISO Certification: No ISO Certification information available
Features: Clear
Incise Area Length (Metric): 30 cm
Incise Area Width (Metric): 30 cm
Material: Plastic
Model: 2057
Procedure: Obstetrics and Gynaecology
Product Color: Transparent
Product Type: Incise Pouch
Product Type Free Format: Drape
Product Use: Incise
Sterile: Yes
Therapeutic Area and Conditions: General Surgery, Obstetrics and Gynaecology
Units per Pack: 10

Dimensions and Classifications

Overall Length (Imperial): 34 in
Overall Length (Metric): 87 cm
Overall Width (Imperial): 29 in
Overall Width (Metric): 74 cm

3M™ Scotchpak™ Polyester Backing Film Laminate, 9727, Configurable Roll

3M ID 7100187916

Details

Translucent
Occlusive
Heat sealable
Controlled Caliper

Typical properties

Backing (Carrier) Material: Polyester
Brands: Scotchpak™
Caliper: 2.00 mils
Caliper (Metric): 50.8 µm
Catalog Number: 9727
Elongation CD: 59%
Elongation MD: 70%
Factory ISO Certification: No ISO Certification information available
Heat Seal: 11 lbs/in
Heat Seal (Metric): 48.92 N/25.4 mm
MVTR (g/m²/24 hr): 7
Maximum Length (Imperial): 4300 yd
Maximum Length (Metric): 3931 m
Oxygen Transmission (cc/m²/24hr): 80
Product Color: Translucent
Sample Roll: 6 in x 25 yds
Sample Roll (Metric): 15 cm x 23 m
Tensile CD: 15 lbs/in
Tensile CD (Metric): 66.7 N/25.4 mm
Tensile MD: 12 lbs/in
Tensile MD (Metric): 53.4 N/25.4 mm
eClass 14 Classification Group: 41011103

FUTURO™ Wrap Around Ankle Support

3M ID CBGBLW011010 UPC 00051131200791

Details

Moderate-support design offers customizable levels of compression and support
Helps support stiff, sore, or injured ankles
Easy-to-use design for personalized adjustment
Breathable materials allow air to circulate and help keep skin dry
Lifts and supp

Typical properties

Body Part: Ankle
Brands: FUTURO™
Condition: Arthritis, Pinched Nerve, Plantar Fasciitis, Sprains, Strains, Swelling, Tendonitis
Factory ISO Certification: No ISO Certification information available
Fit Range: MEDIUM fits: 8" to 9"
LARGE fits: 9" to 10"
Material: Nylon, Polyester, Rubber, Spandex
Product Color: Beige
Product Type: Sleeve, Wrap around
Product Use: Arch/Heel Pain, Exercise, Foot, Arch & Heel Pain, General Support, General Support for Athletic Activity, Hiking, Moderate/Occasional Pain, Recovery, Running, Walking
Size: Large, Medium
Sizes Available: Medium, Large
Support Level: Moderate
Support and Compression Level: Moderate
Type: Support
Where to Measure: Measure around ankle.
eClass 14 Classification Group: 34200201

FUTURO™ Ultra Performance Knee Stabilizer

3M ID CBGBLW011047 UPC 00051131201477

Details

Four-way, stretch-knit fabric conforms to your knee for comfort and moderate-stabilizing support

Helps provide support to stiff, weak or injured knees

Breathable fabric for cooling comfort

Cushioning gel ring around your patella promotes compression an

Typical properties

Body Part: Knee

Brands: FUTURO™

Condition: Arthritis, Jumper's Knee, Patella Tracking, Pinched Nerve, Runner's Knee, Sprains, Strains, Swelling, Tendonitis

Factory ISO Certification: No ISO Certification information available

Fit Range: MEDIUM fits: Calf: 14" to 16" Thigh: 16.5" to 18.5"
LARGE fits: Calf: 16" to 18" Thigh: 18.5" to 20.5"

Package Contents: 1/pack

Product Color: Gray

Product Type: Sleeve

Product Use: During Strong Activity, General Support for Athletic Activity, Medial/Lateral Support, Moderate/Occasional Pain, Prevention, Recovery, Sprains, Strains, Weak, Sore Muscles & Injured Knees

Size: Large, Medium

Sizes Available: Medium, Large

Support Level: Moderate

Support and Compression Level: Moderate

Type: Stabilizer

Where to Measure: Measure 4" from center of knee cap down calf and up thigh.

eClass 14 Classification Group: 34200201

FUTURO™ Cervical Collar, 09027ENR, Adjustable

3M ID 70007013793 UPC 00051131201361

Details

Provides moderate support to your injured neck
Intended to help provide support to necks suffering from injuries like whiplash, pinched nerves, mild neck pain and stiffness
Chin strap adjusts the collar height for a personalized fit
Adjustable circumfe

Typical properties

Body Part: Neck
Brands: FUTURO™
Condition: Pinched Nerve, Whiplash
Factory ISO Certification: No ISO Certification information available
Fit Range: Neck Circumference: 11" to 20"
Neck Height: 2.5" to 5"
Material: Cotton, Modal Acrylic, Nylon, Polyester, Polyurethane
Product Color: White
Product Type: Collar
Size: Adjustable
Sizes Available: One Size - Adjustable
Support Level: Moderate
Support and Compression Level: Moderate
Type: Collar
Where to Measure: Measure the circumference and height of neck and adjust to fit.
eClass 14 Classification Group: 34200201

Nexcare™ Blister Waterproof Bandages BWB-06, 1 1/16 in x 2 1/4 in

3M ID 70005225506 UPC 00051131208704

Details

Advanced water-resistant adhesive sticks to damp or sweaty skin
Waterproof design stays on skin in the bath, shower or pool
Gel pad helps reduce pain and protect cuts, scrapes and blisters
Unique shape provides a better seal around the pad
Leaves mini

Typical properties

Application: Blister, Hands / Heels, Sports, Waterproof
Brands: Nexcare™
Factory ISO Certification: No ISO Certification information available
Material: Clear Film, Hydrocolloid
Package Contents: 6 Pack
Product Color: Transparent
Product Type: Bandage
Properties: Breathable, Non-Stick Pad, Waterproof
Size: One Size Fits Most
Sizes Available: 6 ct. at 1-1/16" x 2-1/4" (26mm x 57mm)
Solution for: Blister, Heels/Toes, Sports, Waterproof
Waterproof: Yes
Wound Type: Blisters
eClass 14 Classification Group: 34400201

Dimensions and Classifications

Overall Length (Metric): 57 mm
Overall Width (Metric): 27 mm

Nexcare™ Soft & Stretch Tape 751, 1 in x 216 in (25,4 mm x 5,48 m)

3M ID 70007020665 UPC 00051131667778

Details

Conforms comfortably to multiple body parts
Long-lasting adhesion
Breathable design provides lasting comfort
Perforated every 2 inches for easy application
Dermatologist tested and hypoallergenic
Known in hospitals as 3M™ Medipore™ H Surgical Tape
P

Typical properties

Brands: Nexcare™
Factory ISO Certification: No ISO Certification information available
Material: Cloth
Product Color: White
Product Type: Tape

Dimensions and Classifications

Overall Length (Imperial): 216 in
Overall Width (Imperial): 1 in
Overall Width (Metric): 25.4 mm

ACE™ Brand Contoured Back Support

3M ID COBBLW014083 UPC 00051131208919

Details

Designed to offer customizable levels of compression
Adjustable design offers a personalized fit
Low-profile and convenient to wear under clothing or athletic gear
Anatomical design allows full range of motion
Soft lining and finished edges for enhanc

Typical properties

Body Part: Back
Brands: ACE™
Factory ISO Certification: No ISO Certification information available
Fit Range: Up to 48" waist
Ideal For: Baseball, Basketball, Cross training, Football, Golf, Hockey, Soccer, Tennis, Volleyball
Latex-free: No
Material: Nylon, Polyester, Polypropylene, Rubber, Spandex
Product Color: Black
Product Type: Support
Size: Adjustable
Sizes Available: One Size - Adjustable
Support Level: Moderate
Support Level Description: Provides light compression, support and therapeutic heat retention to help relieve symptoms associated with minor sprains, strains and arthritis.
Type: Support
Where to Measure: Measure around waist.
eClass 14 Classification Group: 34200201

ACE™ Brand Adjustable Hinged Knee Brace

3M ID COBBLW014130 UPC 00051131200029

Details

Provides firm, stabilizing compression to weak, sore muscles and joints
Wrap-around style for easy on, easy off
Adjustable straps for customizable support and compression
Convenient design can be worn on either left or right knee
Ideal for stiff, weak

Typical properties

Body Part: Knee
Brands: ACE™
Closure Method: Hook & Loop
Condition: Sprains, Strains
Factory ISO Certification: No ISO Certification information available
Fit Range: 16" to 22"
Ideal For: Baseball, Basketball, Cross training, Football, Golf, Hockey, Soccer, Tennis
Material: Aluminum, Neoprene, Nylon, Polypropylene
Performance Zone Category: Injury Prevention
Product Color: Black
Product Type: Brace
Product Use: Medial/Lateral Support, Sprains & Strains
Properties: Adjustable, Non Latex Containing, Odor Control
Size: Adjustable
Sizes Available: One Size - Adjustable
Support Level: Firm, Firm-Stabilizing
Support Level Description: Provides the highest level of support and stabilization, using flexible, hinged, plastic and/or aluminum stabilizers to help reduce risk of re-injury and relieve symptoms associated with acute injuries
Type: Brace
Where to Measure: Measure 3" above kneecap.
eClass 14 Classification Group: 34200201

ACE™ Brand Energizing Hand Support

3M ID COBBLW014183 UPC 00051131198401

Details

Adjusts for a snug fit
Easy on, easy off wrap design
Soft, breathable materials enhance comfort
Designed for all-day wear
Convenient design can be worn on your right or left hand
Size: S/M, L/XL
ACE is America's most trusted brand of braces, support

Typical properties

Body Part: Hand
Brands: ACE™
Factory ISO Certification: No ISO Certification information available
Fit Range: S/M fits: 6.5" to 8"
L/XL fits: 8" to 9.5"
Latex-free: Yes
Performance Zone Category: Return to Activity
Product Color: Beige
Product Type: Support
Properties: Breathable, Non Latex Containing
Size: Large/X-Large, Small/Medium
Sizes Available: Large/X-Large, Small/Medium
Support Level: Mild, Moderate
Support Level Description: Provides light compression, support and therapeutic heat retention to help relieve symptoms associated with minor sprains, strains and arthritis.
Type: Support
Where to Measure: Measure around hand, above thumb.
eClass 14 Classification Group: 34200201

ACE™ Brand Compression Knee Support

3M ID COBBLW014196 UPC 00051131212183

Details

Provides support to weak, sore muscles, above and below your knee
Anatomical shape for optimal fit and joint protection
Dual-stretch, power knit fabric delivers comfortable, even compression
Comfort panel behind your knee helps reduce bunching
Flexibl

Typical properties

Body Part: Knee
Brands: ACE™
Condition: Swelling
Factory ISO Certification: No ISO Certification information available
Fit Range: S/M fits: 12" to 17"
L/XL fits: 17" to 22"
Latex-free: Yes
Material: Nylon, Polyester, Spandex
Package Contents: 1/pack
Performance Zone Category: Injury Care
Product Color: Gray
Product Type: Support
Product Use: General Soreness, Support for Arthritic Joints, Swelling
Properties: Breathable, Non Latex Containing, Reusable, Washable
Size: Large/X-Large, Small/Medium
Sizes Available: Large/X-Large, Small/Medium
Support Level: Mild
Where to Measure: Measure around kneecap while standing.
eClass 14 Classification Group: 34200201

Dimensions and Classifications

Overall Depth (Imperial): 1.5 in
Overall Height (Imperial): 5.125 in
Overall Width (Imperial): 3.75 in

ACE™ Reusable Cold/Hot Pack with Compression Wrap 207519

3M ID 70007019865 UPC 00051131203983

Details

Soft outer pouch is comfortable against your skin
Bandage wrap holds the gel pack in place for hassle-free relief
Reuse again and again
Heat therapy is great for muscle aches, cramps, and stiffness
Cold therapy is ideal for sprains, strains, bumps, an

Typical properties

Body Part: Multi-Purpose
Brands: ACE™
Factory ISO Certification: No ISO Certification information available
Injury: Arthritis, Bumps/Bruises, Insect Bites, Muscle Aches/Cramps, Sprains & Strains, Swelling
Product Color: Beige
Product Type: Hot/Cold Therapy
Properties: Reusable
Size: Adjustable
Sizes Available: Adjustable
Type: Hot/Cold Therapy
eClass 14 Classification Group: 34400201

ACE™ Shoulder Hot/Cold Wrap 208612, One Size - Adjustable

3M ID 70007042321 UPC 00051131221680

Details

Freeze the two gel inserts for at least two hours for a shoulder ice pack
Microwave the gel inserts for 20 seconds for heat therapy
Easy to use design surrounds your shoulder from front to back
Stretchy neoprene-blend materials provide a contoured fit

Typical properties

Body Part: Shoulder

Brands: ACE™

Factory ISO Certification: No ISO Certification information available

Latex-free: Yes

Product Type: Hot/Cold Therapy

Size: Adjustable

eClass 14 Classification Group: 34400201

FUTURO™ Stirrup Ankle Brace, 48442EN, Adjustable

3M ID 70007013454 UPC 00051131200807

Details

Anatomically designed shell helps limit lateral motion after an acute injury
Soft-edge design for extra comfort in shoe
Pre-inflated and adjustable air cells for improved comfort and fit
Adjustable heel strap accommodates any foot size
Wraparound styl

Typical properties

Body Part: Ankle
Brands: FUTURO™
Condition: Sprains, Strains
Factory ISO Certification: No ISO Certification information available
Material: Nylon, Polyethylene, Polypropylene, Polyurethane, Thermoplastic Elastomer (TPE)
Product Color: Black
Product Type: Brace
Product Use: Sprains, Strains
Size: Adjustable
Sizes Available: One Size - Adjustable
Support and Compression Level: Firm
Type: Brace
eClass 14 Classification Group: 34200201

FUTURO™ Comfort Stabilizing Wrist Brace

3M ID CBGBLW011033 UPC 00051131196773

Details

Provides moderate-stabilizing support to sore, weak and injured wrists
Breathable, lightweight materials for all-day comfort
Low-cut design lets your fingers move naturally
Three-strap, hook-and-loop design for custom comfort
Palmar splint adjusts for

Typical properties

Body Part: Wrist
Brands: FUTURO™
Colors Available: Black
Condition: Arthritis, Carpal Tunnel Syndrome, Pinched Nerve, Repetitive Stress Injury, Sprains, Strains, Swelling, Tendonitis, Thumb Hyperextension
Factory ISO Certification: No ISO Certification information available
Fit Range: 5.5" to 8.5"
Material: Aluminum, Nylon, Polyester, Polyurethane, Spandex
Product Color: Black
Product Type: Brace
Product Use: During Strong Activity, General Support, General Support for Athletic Activity, Moderate/Occasional Pain, Prevention, Recovery, Sprains, Strains, Symptoms of Carpal Tunnel Syndrome
Size: Adjustable
Sizes Available: One Size - Adjustable
Support Level: Moderate
Support and Compression Level: Moderate, Moderate-Stabilizing
Type: Brace, Stabilizer
Where to Measure: Measure around wrist at smallest point.
eClass 14 Classification Group: 34200201

FUTURO™ Comfort Stabilizing Back Support, 46820ENR, Adjustable

3M ID 70007016937 UPC 00051131196919

Details

Moderate-support design offers customizable levels of support and compression
Dual pull-cord system provides a personalized fit for all-day comfort
Removable lumbar pads let you customize cushioning and support
Side stretch panels resist bunching and s

Typical properties

Body Part: Back

Brands: FUTURO™

Condition: Back Pain, Lumbago, Sprains, Strains

Factory ISO Certification: No ISO Certification information available

Fit Range: 29" to 51"

Material: EVA, Neoprene, Nylon, Polyester, Polyurethane, Spandex

Product Color: Black

Product Type: Support

Product Use: During Strong Activity, General Support, Lower Back Support, Moderate/Occasional Pain, Post Surgery, Prevention, Recovery, Severe/Chronic back pain, Support for a saggy abdomen

Size: Adjustable

Sizes Available: One Size - Adjustable

Support Level: Moderate

Support and Compression Level: Moderate

Type: Stabilizer

Where to Measure: Measure around waist at navel.

eClass 14 Classification Group: 34200201

Nexcare™ Flexible Fabric Bandages 665-30PB, 30 ct

3M ID 70005143691 UPC 00051131995222

Details

Flexible woven fabric stretches to move with you
Covers and protects cuts, scrapes and blisters
Unique shape provides a better seal around the pad
Leaves minimal adhesive residue on skin when removed
Available In: 30 ct. Assorted
Not made with natura

Typical properties

Application: Heavy Duty
Brands: Nexcare™
Factory ISO Certification: No ISO Certification information available
Material: Fabric
Package Contents: 30 Pack
Product Color: Tan
Product Type: Bandage
Size: Assorted
Sizes Available: 30 ct. Asst: 8 at 1.15" x 3" (29mm x 76mm), 14 at .9" x 2.25" (22mm x 57mm), 8 at .96" x 1.15" (24mm x 29mm)
Solution for: Heavy Duty
Waterproof: No
Wound Type: Cuts / Scrapes / Abrasions
eClass 14 Classification Group: 34400201

Nexcare™ Skin Crack Care, 112, 0.24 fl. oz. Bottle

3M ID 70005122513 UPC 00051131861015

Details

- Fast-drying formula
- Does not sting on contact
- Long-lasting seal protects your skin
- Helps block environmental elements
- Helps fill and seal cracks
- Ideal for skin cracked from harsh cleaners and chemicals
- Great for use on fingers, hands, feet and elbow

Typical properties

- Application: Caregivers, Hands / Heels, Skin Cracks, Waterproof
- Brands: Nexcare™
- Factory ISO Certification: No ISO Certification information available
- Package Contents: 1 Pack
- Product Color: Transparent
- Product Type: Skin Products
- Properties: Waterproof
- Solution for: Skin Care, Skin Cracks, Waterproof
- Wound Type: Other
- eClass 14 Classification Group: 34180307

ACE™ Brand Deluxe Ankle Stabilizer

3M ID COBBLW014072 UPC 00051131226210

Details

Reinforced side stabilizers help limit lateral motion
Design offers customizable levels of compression and support
Adjustable features for custom comfort
Easy-to-use design for hassle-free wear
Breathable materials allow air to circulate and helps keep

Typical properties

Body Part: Ankle
Brands: ACE™
Factory ISO Certification: No ISO Certification information available
Fit Range: 8" to 10"
Latex-free: Yes
Material: Nylon, Polyester, Spandex
Product Color: Black
Product Type: Support
Properties: Adjustable
Size: Adjustable
Sizes Available: One Size - Adjustable
Support Level: Firm
Type: Support
Where to Measure: Measure around ankle.
eClass 14 Classification Group: 34200201

ACE™ Brand Adjustable Knee Support with Side Stabilizers

3M ID COBBLW014122 UPC 00051131216594

Details

New! Larger perforations for ultimate breathability
Provides moderate, adjustable stabilizing compression and support to stiff, weak, or sore muscles, and joints
Dual side stabilizers for lateral support
Three adjustable straps for customizable support

Typical properties

Body Part: Knee
Brands: ACE™
Condition: Arthritis, Sprains, Strains, Swelling
Factory ISO Certification: No ISO Certification information available
Fit Range: 11" to 22"
Latex-free: Yes
Material: Neoprene, Nylon, Polyester, Spandex, Steel
Performance Zone Category: Return to Activity
Product Color: Black
Product Type: Support
Product Use: General Soreness, Sprains & Strains, Support for Arthritic Joints, Swelling
Properties: Adjustable, Breathable, Non Latex Containing, Odor Control
Size: Adjustable
Sizes Available: One Size - Adjustable
Support Level: Firm, Moderate
Type: Brace, Support
Where to Measure: Measure 3" above kneecap.
eClass 14 Classification Group: 34200201

ACE™ Contoured Back Support 205324, One Size Adjustable

3M ID 70007046116 UPC 00051131221789

Details

Designed to offer customizable levels of compression
Adjustable design offers a personalized fit
Low-profile and convenient to wear under clothing or athletic gear
Anatomical design allows full range of motion
Soft lining and finished edges for enhanc

Typical properties

Body Part: Back
Brands: ACE™
Factory ISO Certification: No ISO Certification information available
Fit Range: Up to 48" waist
Latex-free: No
Material: Neoprene, Nylon, Polyester, Spandex
Performance Zone Category: Return to Activity
Product Color: Black
Product Type: Support
Product Use: Back Pain, General Soreness
Properties: Adjustable, Reusable
Size: Adjustable
Sizes Available: One Size - Adjustable
Support Level: Moderate
Support Level Description: Provides light compression, support and therapeutic heat retention to help relieve symptoms associated with minor sprains, strains and arthritis.
Where to Measure: Measure around waist.
eClass 14 Classification Group: 34200201

ACE™ Brand Compression Knee Brace with Side Stabilizers

3M ID COBBLW014195 UPC 00051131198234

Details

Dual side stabilizers provide lateral support while allowing for full range of motion
Low-profile design fits the contours of your knee
Four-way stretch, knit fabric delivers compression
Comfort panel behind your knee helps reduce bunching
Easy-to-use

Typical properties

Body Part: Knee

Brands: ACE™

Condition: Sprains, Strains

Factory ISO Certification: No ISO Certification information available

Fit Range: SMALL fits: 12" to 14.5"
MEDIUM fits: 14.5" to 17"
LARGE fits: 17" to 19.5"
X-LARGE fits: 19.5" to 22"

Package Contents: 1/pack

Product Color: White

Product Type: Brace

Properties: Breathable

Size: Large, Medium, Small, X-Large

Sizes Available: Small,Medium,Large,X-Large

Support Level: Moderate

Support Level Description: Provides moderate support and stabilization to help prevent re-injury and relieve symptoms associated with strains, sprains, arthritis and repetitive stress injuries.

Where to Measure: Measure around kneecap while standing.

eClass 14 Classification Group: 34200201

ACE™ Brand Reusable Cold Compress

3M ID COBBLW014209 UPC 00051131204003

Details

Helps relieve pain and reduce swelling caused by sprains, strains, muscle aches, bumps, bruises, minor burns and more
Soft-touch fabric can be applied directly to your skin
Simply freeze and remove when needed
Flexible design contours to multiple body

Typical properties

Application: Securing Hot/Cold
Body Part: Abdomen, Ankle, Back, Calf, Elbow, Foot, Hand, Knee, Multi-Purpose, Shoulder, Wrist
Brands: ACE™
Factory ISO Certification: No ISO Certification information available
Injury: Bumps/Bruises, Insect Bites, Sprains & Strains, Swelling, Toothaches
Latex-free: Yes
Performance Zone Category: Injury Care
Product Color: Blue
Product Type: Hot/Cold Therapy
Properties: Non Latex Containing, Reusable
Sizes Available: Small, Large
Type: Cold Therapy
eClass 14 Classification Group: 34400201

Nexcare™ Heel Blister Comfort Cushion CCH-04, 2 3/4 in x 1 3/4 in (7 cm x 4,5 cm)

3M ID 70005268845 UPC 00051141994956

Details

Strong adhesive stays put for lasting comfort
Reduces friction with your footwear
Soft cushion absorbs impact
Water-resistant formula can be worn in the shower
Flexible material conforms to heels with ease
Stretchy material moves with you
Extended a

Typical properties

Application: Blister
Brands: Nexcare™
Factory ISO Certification: No ISO Certification information available
Latex: No
Material: Clear Film
Package Contents: 4 Pack
Product Color: Transparent
Product Type: Bandage
Properties: Conformable, Cushioning, Waterproof
Size: One Size Fits Most
Sizes Available: 4 ct. at 2-3/4" x 1-3/4" (7cm x 4,5cm)
Solution for: Heels/Toes
Units per Pack: 4
Waterproof: Yes
Wound Type: Blisters
eClass 14 Classification Group: 34400201

Dimensions and Classifications

Overall Length (Imperial): 2.75 in
Overall Length (Metric): 7 cm
Overall Width (Imperial): 1.75 in
Overall Width (Metric): 4.5 cm

FUTURO™ Back For Her Support, 95348ENR, Adjustable

3M ID 70007017026 UPC 00051131212442

Details

Design offers customizable levels of moderate support and compression
Adjustable straps provide a personalized fit
Contoured fit is tailored to the natural curves of a woman's back
Breathable materials enhance airflow to help keep skin dry
Low-profile

Typical properties

Body Part: Back
Brands: FUTURO™
Factory ISO Certification: No ISO Certification information available
Fit Range: 29" to 42"
Material: Acetal Plastic (POM), Nylon, Polyester, Polypropylene, Polyurethane, Rubber, Spandex
Product Color: Blue
Product Type: Brace
Product Use: General Support, Lower Back Support
Size: Adjustable
Sizes Available: One Size - Adjustable
Support Level: Moderate
Support and Compression Level: Moderate
Type: Support
Where to Measure: Measure around waist at navel.
eClass 14 Classification Group: 34200201

ACE™ Brand Compression Elbow Support

3M ID CBGBLRUS1525 UPC 00051131208957

Details

Stretchy design conforms to your elbow for comfort and mild compression
Designed with neoprene-blend fabrics for comfort, warmth and support
Flexible design allows a full range of motion
Convenient design can be worn on either elbow
Ideal for stiff, w

Typical properties

Body Part: Elbow

Brands: ACE™

Factory ISO Certification: No ISO Certification information available

Fit Range: L/XL fits 10" to 12.5", S/M fits: 9" to 10.5"

Product Type: Support

Size: Large/X-Large, Small/Medium

Sizes Available: Large/X-Large, Small/Medium

Support Level: Mild

Type: Support

Where to Measure: Measure around elbow joint.

eClass 14 Classification Group: 34200201

Nexcare™ DUO Bandages

3M ID CBGBLRUS1530 UPC 00051131223035

Details

- Holds strong up to 24 hours
- Pain-free removal
- Flexible, skin-friendly fabric
- 360-degree seal around pad
- Non-stick pad
- Breathable backing
- Not made with natural rubber latex

Typical properties

- Brands: Nexcare™
- Factory ISO Certification: No ISO Certification information available
- Material: Plastic
- Package Contents: 40 Pack,8 Pack,20 pack,100 Pack
- Product Color: Tan
- Product Type: Bandage
- Size: Assorted
- Sizes Available: 4 in x 2 in, 3 in x 1.15 in, 2.25 in x .9 in, 1.15 in x .06 in,
- eClass 14 Classification Group: 34400201

3M™ Prevena Restor™ BellaForm™ Incision Management System

Details

Available in three dressing options with for use to manage incisions and the surrounding soft tissue (21x19 cm, 24x22 cm & 29x27cm) for up to 7 days
The 3M™ Prevena™ Plus 125 Therapy Unit - 14 day provides pre-set, continuous NPWT at -125mmHg up to 14 da

Typical properties

Brands: Prevena Restor™

Factory ISO Certification: No ISO Certification information available

Product Type: 14-day Pump

Dimensions and Classifications

Overall Length (Metric): 19 cm, 22 cm, 27 cm

Overall Width (Metric): 21 cm, 24 cm, 29 cm

3M™ V.A.C.® Granufoam™ Bridge Dressing

3M ID B5005265138

Details

Concomitant therapies provide benefits of off-loading and 3M™ V.A.C.® Therapy Helps improve mobility, allowing patients to resume activities of daily living
The 3M™ V.A.C.® Granufoam™ Bridge Dressing Kit contains: specialized 3M™ V.A.C.® Granufoam™ Dres

Typical properties

Brands: V.A.C.®

Factory ISO Certification: No ISO Certification information available

eClass 14 Classification Group: 34210701

3M™ Snap™ Plus -125 mmHg Therapy Cartridge

Details

A mechanically powered negative pressure device that **allows patient mobility**¹ -no batteries or leads that interfere with daily activities
Discreet device is silent,

Typical properties

Brands: Snap™

Factory ISO Certification: No ISO Certification information available

Pressure Setting: 125 mmHg

Volume (Metric): 150 mL

eClass 14 Classification Group: 34210701

ACTIV.A.C.™ Canister with Gel, M8275058/5, 300 ml, 5/cs

3M ID 7100236615 UPC 00849554001992

Details

300 ml canister with Gel for the 3M™ ActiV.A.C.™ and 3M™ V.A.C.® Simplicity Therapy Systems
Canisters feature 3M™ SensaT.R.A.C.™ Tubing
Available in cases of 5 and 10

Typical properties

Brands: ActiV.A.C.™
Factory ISO Certification: No ISO Certification information available
Volume (Metric): 300 mL
eClass 14 Classification Group: 34210701

3M™ Touchless Care™ Zinc Oxide Protectant Spray

Details

Creates a translucent coating that enables skin inspection without product removal

Creates a breathable, waterproof coating on the skin²

Typical properties

Brands: Touchless Care™

Factory ISO Certification: No ISO Certification information available

Volume (Imperial): 2 fl oz, 4.5 fl oz

PREVENA PLUS™ CUSTOMIZABLE™ Dressing Kit, PRE4055US, 5/pk

3M ID 7100237289 UPC 00849554005303

Typical properties

Brands: Prevena™

Factory ISO Certification: No ISO Certification information available

3M™ Medical Tape 9952, Single Sided Polyester, 63# liner, CONFIGURABLE

3M ID 7100127437

Details

Tackified Acrylic Adhesive
Fluid Resistant
Good Processability

Typical properties

Adhesive Material: Acrylate
Adhesive Type: Acrylic/Acrylate (Tack)
Backing Caliper: 10 mil
Backing Caliper (Metric): 250 Micron
Backing Material: Polyester
Backing Thickness (Imperial): 10 mil
Backing Thickness (Metric): 250 Micron
Brands: 3M™
Breathable: No
Conformability: Low
Factory ISO Certification: No ISO Certification information available
Fluid Resistance Backing/Carrier: Yes
Liner Caliper (Metric): 120 Micron
Liner Caliper (mils): 4.9 mil
Liner Color: White
Liner Material: Paper
Liner Weight: 63.0 lb.
Liner Weight (Metric): 103 g/m²
Material: Polyester
Maximum Length (Metric): 366 m
Maximum Width Capacity: 48 in
Maximum Width Capacity (Metric): 1220 mm
Printable Backing: Yes
Product Color: Ivory
Product Type: Polyester, Incise & Polyurethane
Product Usage: Adhesion to Substrate
Sterilization Method: Ethylene Oxide (EO), Gamma, Steam
Tape Total Caliper (Metric): 280.0 Micron
Tape Type: Single-sided Polyester Tape
eClass 14 Classification Group: 34180101

Dimensions and Classifications

Overall Thickness (Imperial): 1 in
Overall Thickness (Metric): 0.28 mm
Overall Width (Imperial): 48 in
Overall Width (Metric): 121.92 cm

FUTURO™ Quick Strap Ankle Support 47736EN, Adjustable

3M ID 70007012498 UPC 00051131196926

Details

Moderate-support design offers customizable levels of compression and support
Adjustable features for custom comfort
Helps support stiff, sore, or injured ankles
Materials allow air to circulate and help keep skin dry
Wear with a sock underneath for e

Typical properties

Body Part: Ankle
Brands: FUTURO™
Condition: Sprains, Strains
Factory ISO Certification: No ISO Certification information available
Fit Range: 7.5" to 11"
Material: Acetal Plastic (POM), Metal, Neoprene, Nylon, PVC, Polyester, Polyurethane, Rubber, Spandex, Thermoplastic Elastomer (TPE)
Product Color: Black
Product Type: Strap
Product Use: General Support, Weak, Sore or Injured Ankle
Size: Adjustable
Sizes Available: One Size - Adjustable
Support and Compression Level: Moderate
Type: Support
Where to Measure: Measure around ankle.
eClass 14 Classification Group: 34200201

FUTURO™ Tennis Elbow Strap

3M ID CBGBLW011032 UPC 00051131201545

Details

Provides firm support to weak, sore and injured tendons
Adjustable strap provides a customizable fit
Tendon pad applies zoned pressure to help provide support to elbows affect by the symptoms of tendonitis
Breathable materials help keep you cool
Wear

Typical properties

Body Part: Elbow
Brands: FUTURO™
Condition: Arthritis, Golfer's Elbow, Pinched Nerve, Sprains, Strains, Swelling, Tendonitis, Tennis Elbow
Factory ISO Certification: No ISO Certification information available
Fit Range: 7" to 14"
Material: Acetal Plastic (POM), Nylon, Polyester, Polyurethane
Product Color: Black
Product Type: Strap, Wrap around
Product Use: During Strong Activity, General Support, General Support for Athletic Activity, Moderate/Occasional Pain, Post Cast, Prevention, Recovery, Tendonitis
Size: Adjustable
Sizes Available: One Size - Adjustable
Support Level: Firm
Support and Compression Level: Firm, Firm-Stabilizing
Type: Wrap around
Where to Measure: Measure around forearm below elbow.
eClass 14 Classification Group: 34200201

FUTURO™ Wrist Support Strap, 46378ENR, Adjustable, Black

3M ID 70007016911 UPC 00051131201392

Details

Design offers customizable levels of moderate compression and support
Easy-to-use, wraparound design with dual straps for personalized comfort
Foam cushion provides soothing comfort
Wear on either wrist for versatility
Fits discreetly under clothing

Typical properties

Body Part: Wrist
Brands: FUTURO™
Condition: Sprains, Strains
Factory ISO Certification: No ISO Certification information available
Fit Range: 5.5" to 9.5"
Product Color: Black
Product Type: Support
Product Use: General Support, Sore, Weak or Injured Wrist, Stiff, Weak or Injured Wrist
Size: Adjustable
Sizes Available: One Size - Adjustable
Support Level: Moderate
Support and Compression Level: Moderate
Type: Wrap around
Where to Measure: Measure around wrist.
eClass 14 Classification Group: 34200201

FUTURO™ Comfort Knee with Stabilizers

3M ID CBGBLW011057 UPC 00051131200753

Details

Provides moderate-stabilizing support to weak and sore knees
Side stabilizers enhance support without limiting mobility
Easy-to-use slip on sleeve
Flexible fabric promotes a full range of motion
Wear on either knee for versatility
Ideal for stiff, we

Typical properties

Body Part: Knee
Brands: FUTURO™
Condition: Arthritis, Jumper's Knee, Patella Tracking, Pinched Nerve, Runner's Knee, Sprains, Strains, Swelling, Tendonitis
Factory ISO Certification: No ISO Certification information available
Fit Range: SMALL fits: 12" to 14.5"
MEDIUM fits: 14.5" to 17"
LARGE fits: 17" to 19.5"
Product Color: Beige, Gray
Product Type: Sleeve, Support
Product Use: During Strong Activity, General Support, General Support for Athletic Activity, Medial/Lateral Support, Moderate/Occasional Pain, Prevention, Recovery, Sprains, Strains, Weak, Sore Muscles & Injured Knees
Size: Large, Medium, Small
Sizes Available: Small,Medium,Large
Support Level: Moderate
Support and Compression Level: Moderate
Type: Brace, Stabilizer
Where to Measure: Measure around kneecap while standing.
eClass 14 Classification Group: 34200201

Nexcare™ Gentle Paper First Aid Tape

3M ID COBBLW014020 UPC 00051131913868

Details

From the #1 leader in U.S. hospital tapes
Ideal for securing gauze and dressings
Adhesive sticks to wet, damp skin
Conformable
Breathable design provides comfort
Tears easily in both directions for hassle-free application
Hypoallergenic and Dermatol

Typical properties

Brands: Nexcare™
Factory ISO Certification: No ISO Certification information available
Material: Paper
Product Color: White
Product Type: Tape

Dimensions and Classifications

Overall Length (Imperial): 8 yd, 10 yd
Overall Length (Metric): 9.1 m, 9.14 m
Overall Width (Imperial): 0.75 in, 1 in, 2 in
Overall Width (Metric): 19.05 mm, 25.4 mm, 50.8 mm

ACE™ Brand Elastic Bandage with Clips – Black

3M ID COBBLW014055 UPC 00051131215702

Details

Innovative clip snaps in place, holds securely and is easily adjusted
Provides moderate support to weak, sore muscles and joints
Comfortable design is intended for prolonged wear
Easy-to-use wrap design
Fits discreetly under clothing
Wrap conforms to

Typical properties

Body Part: Multi-Purpose
Brands: ACE™
Factory ISO Certification: No ISO Certification information available
Latex-free: Yes
Performance Zone Category: Injury Care
Product Color: Black
Product Type: Bandage
Properties: Breathable, Non Latex Containing, Reusable
Support Level: Moderate
Type: Bandage
eClass 14 Classification Group: 34200190

Dimensions and Classifications

Overall Length (Imperial): 63.6 in
Overall Width (Imperial): 3 in, 4 in

ACE™ Brand Knee Strap

3M ID COBBLW014121 UPC 00051131198210

Details

Applies moderate pressure on your injured tendon
Reinforced gel pad design delivers targeted pressure and will not compress or flatten out during use
Adjustable hook-and-loop design for custom comfort
Breathable material releases excess heat for cooling

Typical properties

Body Part: Knee
Brands: ACE™
Condition: Jumper's Knee, Runner's Knee, Sprains, Strains, Tendonitis
Factory ISO Certification: No ISO Certification information available
Fit Range: 12.5" to 17.5"
Latex-free: Yes
Material: Nylon, Polyester, Polyethylene, Polyoxymethylene, Polypropylene, Polyurethane, Spandex, Thermoplastic Elastomer (TPE)
Performance Zone Category: Return to Activity
Product Color: Black
Product Type: Support
Product Use: Runner's/Jumper's Knee, Tendonitis
Properties: Adjustable, Breathable, Non Latex Containing
Size: Adjustable
Sizes Available: One Size - Adjustable
Support Level: Moderate
Support Level Description: Provides adjustable levels of compression, support and therapeutic heat retention to help relieve symptoms associated with strains, sprains, arthritis and muscle pain.
Type: Support
Where to Measure: Measure around leg below kneecap.
eClass 14 Classification Group: 34200201

FUTURO™ Comfort Compression Back Support

3M ID CBGBLWUS1441 UPC 00051131211865

Details

Moderate-Support Design Offers Customizable Levels Of Support And Compression
Dual-Adjustment Straps Provide A Personalized Fit For All-Day Comfort
Side Stretch Panels Resist Bunching And Slipping To Minimize Distractions
Mesh Panels Enhance Airflow To

Typical properties

Body Part: Back
Brands: FUTURO™
Condition: Back Pain, Back Support, Lumbago, Sprains, Strains
Factory ISO Certification: No ISO Certification information available
Fit Range: 32" to 48"
Material: Neoprene, Nylon, Polyester, Polypropylene, Rubber, Spandex
Product Color: Black
Product Type: Support
Product Use: General Support, Lower Back Support, Strained or Sore Back
Size: Adjustable
Sizes Available: One Size - Adjustable
Support Level: Moderate
Support and Compression Level: Moderate
Type: Support
Where to Measure: Measure around waist at navel.
eClass 14 Classification Group: 34200201

Nexcare™ Toe Blister Comfort Cushions CCT-05, 2 3/4 x 1 (7 cm x 2,54 cm)

3M ID 70005264018 UPC 00051131212701

Details

- Strong adhesive stays put for lasting comfort
- Reduces friction with your footwear
- Helps block out water, dirt and germs
- Soft cushion absorbs impact
- Water-resistant formula can be worn in the shower
- Flexible material conforms to toes with ease
- Stretc

Typical properties

- Application: Blister
- Brands: Nexcare™
- Factory ISO Certification: No ISO Certification information available
- Latex: No
- Package Contents: 5 Pack
- Product Color: Transparent
- Product Type: Bandage
- Properties: Conformable, Cushioning, Waterproof
- Size: One Size Fits Most
- Sizes Available: 5 ct. at 2-3/4" x 1" (7cm x 2,6cm)
- Solution for: Heels/Toes
- Units per Pack: 5
- Waterproof: Yes
- Wound Type: Blisters
- eClass 14 Classification Group: 34400201

Dimensions and Classifications

- Overall Length (Imperial): 2.75 in
- Overall Length (Metric): 7 cm
- Overall Width (Imperial): 1 in
- Overall Width (Metric): 2.54 cm

3M™ Attest™ Biological Indicator Incubator for steam, 116

3M ID 7100214720 UPC 00707387094980

Details

14-vial incubator for use with 3M™ Attest™ Steam Biological Indicators 1261, 1261P, 1262 and 1262P
Biological Indicator (BI) results in 24 hours (1261/1261P) and 48 hours (1262/1262P)
Maintains pre-set temperature to 56°C ± 2°C
Interested in final fluo

Typical properties

Biological Indicator System: Standard
Brands: Attest™
Catalog Number: 116
Factory ISO Certification: No ISO Certification information available
Incubation Period: 48 Hour
Maximum Temperature (Celsius): 56 °C
Maximum Temperature (Fahrenheit): 133 °F
Number of Wells: 14
Product Type: Incubator
Sterilization Method: Steam

FUTURO™ Comfort Fit Compression Elbow Support, Adjustable

3M ID 70007070462 UPC 00051131224612

Details

Moderate support and adjustable compression for weak, sore or injured elbows
Designed for all-day and everyday comfort and support
Slip-on comfort sleeve helps prevent pinching or chafing
Ultra breathable and moisture wicking, neoprene blend material t

Typical properties

Body Part: Elbow

Brands: FUTURO™

Condition: Arthritis, Golfer's Elbow, Pinched Nerve, Sprains, Strains, Swelling, Tendonitis, Tennis Elbow

Factory ISO Certification: No ISO Certification information available

Material: Neoprene, Nylon, Polyester, Spandex

Product Color: Gray

Product Type: Support

Size: Adjustable

Support and Compression Level: Moderate

eClass 14 Classification Group: 34200201

3M™ Attest™ Steam Dry Incubator, 118, Small, 1 Each/Case

3M ID 7100214721 UPC 00707387095000

Details

14-vial incubator for use with 3M™ Attest™ Steam Biological Indicators 1261, 1261P, 1262 and 1262P

Biological Indicator (BI) results in 24 hours (1261/1261P) and 48 hours (1262/1262P)

Maintains pre-set temperature to 56°C ± 2°C

Interested in final fluo

Typical properties

Biological Indicator System: Standard

Brands: Attest™

Catalog Number: 118

Cladimed Code: Non applicable

Factory ISO Certification: No ISO Certification information available

Incubation Period: 48 Hour

Maximum Temperature (Celsius): 56 °C, 132 °C

Maximum Temperature (Fahrenheit): 133 °F, 270 °F

Number of Wells: 14

Product Type: Incubator

Sterilization Method: Steam

Total Units per Case: 1 per Case

3M™ Medical Tape 9841, Single Sided Polyurethane, 60# liner, Configurable

3M Product Number 9841 3M ID 7100012481

Details

Acrylic Adhesive
Breathable
Fluid Resistant
Good Processability

Typical properties

Brands: 3M™
Factory ISO Certification: No ISO Certification information available
Product Type: Polyester, Incise & Polyurethane
Product Usage: Adhesion to Skin
eClass 14 Classification Group: 34180101

Dimensions and Classifications

Overall Width (Imperial): 48 in
Overall Width (Metric): 121.92 cm

3M™ Scotchcast™ Plus Casting Tape 82000 Series

Details

Water-activated resin lets you control working time according to application needs

High and early strength allows for weight bearing in 20 minutes and provides a durable cast with less chance of breakdown and the need for costly repairs or replacements

Typical properties

Application: Medical

Brands: Scotchcast™

Cladimed Code: M50AF02

Factory ISO Certification: No ISO Certification information available

Model: 82001, 82002, 82002A, 82002B, 82002G, 82002L, 82002R, 82002U, 82002V, 82002W, 82002X, 82002Y, 82003, 82003A, 82003B, 82003G, 82003L, 82003R, 82003U, 82003V, 82003W, 82003X, 82003Y, 82004, 82004A, 82004B, 82004G, 82004L, 82004R, 82004U, 82004X, 82005, 82005B

Product Color: Black, Blue, Bright Green, Green, Green Fluorescent, Light Blue, Orange, Pink, Purple, Red, White, Yellow

Product Use: Casting Tape

Units per Pack: 10

eClass 14 Classification Group: 34200209

Dimensions and Classifications

Overall Length (Imperial): 2 yd, 4 yd

Overall Length (Metric): 1.8 m, 3.6 m

Overall Width (Imperial): 1 in, 2 in, 3 in, 4 in, 5 in

Overall Width (Metric): 2.54 cm, 5.08 cm, 7.62 cm, 10.1 cm, 12.7 cm

Animalintex Poultice

3M ID B00035313 UPC 00051115052798

Details

Aids in wound healing and relieves minor stiffness and soreness
Adsorbs exudates, provides a moist, clean healing site and cushions sore areas
Retains moisture/warmth and helps prevent external contamination due to its occlusive backing
Can also be use

Typical properties

Brands: Private Label
Factory ISO Certification: No ISO Certification information available
Product Type: Poultice
eClass 14 Classification Group: 34210402

Dimensions and Classifications

Overall Length (Imperial): 16 in
Overall Width (Imperial): 8 in

3M™ Scotchcast™ Wet or Dry Cast Padding

Details

Lets you shower, bathe, swim or use a whirlpool
Sheds water and feels comfortably dry to patient in approximately 1 to 3 hours
Allows you to stock only one cast padding for all your patient needs
Suitable for use with all synthetic casting materials, s

Typical properties

Brands: Scotchcast™
Factory ISO Certification: No ISO Certification information available
Model: WDP2, WDP3, WDP4, WDP6
Product Type: Cast Padding
Product Use: Accessory
Units per Pack: 20
Waterproof: Yes
eClass 14 Classification Group: 34200301

Dimensions and Classifications

Overall Length (Imperial): 4 yd
Overall Length (Metric): 3.658 m
Overall Width (Imperial): 2 in, 3 in, 4 in, 6 in
Overall Width (Metric): 50.8 mm, 76.2 mm, 101.6 mm, 152.4 mm

3M™ Tegaderm™ I.V. Transparent Film Dressing with Border

Details

Provides great fit for small-sized patients
Provides a waterproof, sterile barrier to external contaminants including liquids, bacteria and viruses. In vitro testing shows that the transparent film provides a viral barrier from viruses 27 nm in diameter

Typical properties

Border: Yes
Brands: Tegaderm™
Cladimed Code: F51CA07,M50AF02
Clinical Sub-Area: Orthopedics
Condition: I.V. Related
Department: Cardiovascular, Dialysis Center, EMERGENCY, I.V. Therapy, Intensive Care Unit, Medical-Surgical, Oncology, Operating Room-Surgery, Pediatrics, Radiology, Urgent Care, Wound Care
Dressing Type: Film
Factory ISO Certification: No ISO Certification information available
Hypoallergenic: Yes
IV Related Condition Type: Arterial Catheter, CVC Dialysis, CVC Implanted Port, CVC PICC, CVC Short-Term, CVC Tunneled, Epidural Catheter, PICC, PIV
Latex: No
Product Type: Standard Dressing
Product Use: PIV
Therapeutic Area and Conditions: I.V. Therapy
Units per Pack: 50 , 100
Waterproof: Yes
eClass 14 Classification Group: 34180304

Dimensions and Classifications

Overall Length (Imperial): 2.25 in, 3.25 in, 4.25 in, 4.5 in, 6.125 in
Overall Length (Metric): 5.7 cm, 8.5 cm, 10 cm, 10.5 cm, 11.5 cm
Overall Width (Imperial): 2 in, 2.75 in, 3.5 in, 4 in
Overall Width (Metric): 5 cm, 6.9 cm, 7 cm, 8.5 cm, 8.9 cm, 10

3M™ Tegaderm™ Hydrocolloid Dressing

Details

For low to moderate draining wounds. Significantly higher absorbency than leading hydrocolloid at 48 hours

Proven up to 7 day wear time

Smooth outer surface helps reduce the risk of shear and friction

Breathable outer film layer provides consistently h

Typical properties

Brands: Tegaderm™

Dressing Type: Border, Non-border

Factory ISO Certification: No ISO Certification information available

Shape: Sacral

eClass 14 Classification Group: 34210405

Dimensions and Classifications

Overall Length (Imperial): 4 in, 4.75 in, 6 in, 6.75 in, 8 in

Overall Length (Metric): 10 cm, 13 cm, 15.2 cm, 17.1 cm, 20.3 cm

Overall Width (Imperial): 4 in, 5.91 in, 6 in, 6.375 in, 6.75 in

Overall Width (Metric): 10 cm, 12 cm, 15 cm, 15.2 cm, 16.1 c

3M™ Steri-Strip™ Reinforced Adhesive Skin Closures

Details

Strength - Nonwoven rayon backed material reinforced with filaments for strength. (Reference on file)

Cost savings - A low cost alternative to sutures and tissue adhesives¹

Easy on patients - Soft, nonwoven backing and breathable design

Typical properties

Brands: Steri-Strip™

Cladimed Code: F52BC01

Condition: Skin Closure, Wound Care

Department: Critical Care, EMERGENCY, Intensive Care Unit, Labor & Delivery, Medical-Surgical, Operating Room-Surgery, Orthopedics, Pediatrics, Urgent Care, Wound Care

Factory ISO Certification: No ISO Certification information available

Hypoallergenic: Yes

Latex: No

Product Color: White

Product Type: Skin Closures

Sterile: Yes

Therapeutic Area and Conditions: Reinforced Skin Closure Strips

Units per Pack: 25 , 50

eClass 14 Classification Group: 34180306

Dimensions and Classifications

Overall Length (Imperial): 1.5 in, 2 in, 3 in, 3.937 in, 4 in, 4.921 in, 5 in, 29.528 in

Overall Length (Metric): 38 mm, 38.1 mm, 50 mm, 75 mm, 76.2 mm, 100 mm, 101.6 mm, 125 mm

Overall Width (Imperial): 0.125 in, 0.236 in, 0.25 in, 0.472 in, 0.5 in, 0.

3M™ Foam Monitoring Electrode, 2200 Series

Details

Adhesive foam-tape backing and proprietary sticky gel ensure excellent skin contact

Fluid Resistant Foam Backing

30 day out of box performance

3 Day Wear

Cord delivery - organized application delivery system

Foam backing is comfortable for patients,

Typical properties

Age Group: Adult

Backing Material: Foam

Brands: Red Dot™

Case Packaging: 50 Electrodes/Bag; 20 Bags or 1000 Electrodes/Case

Cladimed Code: K51FG01

Department: Cardiac Rehab, Cath Lab, EMS/ER, ICU/CCU, OR, Pediatric ICU

Electrode Size: 1.57" x 1.3"

Electrode Type: Diaphoretic, Fluid Resistant, Monitoring, Value-priced

Factory ISO Certification: No ISO Certification information available

Gel Type: Sticky

Material: Foam

Model: 2244

Monitoring Event: Echo-Cardio, Stress Test, Telemetry/Holter/Event

Package Contents: 50 Electrodes/Bulk Bag

Patient: Adult

Pre-wired: No

Product Type: Electrode

Product Use: Diaphoretic, Monitoring

Radiolucency: Radiolucent, Radiopaque

Skin Prep Included: No

Skin Type: Normal

Solution: Fluid Resistant, Monitoring, Standardization, Value Price

Units per Pack: 50

Wear Time: Up to Three Days

eClass 14 Classification Group: 34580108

Dimensions and Classifications

Overall Length (Imperial): 1.3 in

Overall Length (Metric): 4 cm

Overall Width (Imperial): 1.57 in

Overall Width (Metric): 3.2 cm, 3.3 cm

3M™ Red Dot™ Resting EKG Electrode, 2300 Series

Details

Easy to apply and remove
Tab is convenient for leadwire placement
Superior adhesion with flexibility to reposition as needed
Intimate skin contact ensures accurate EKG traces even on challenging sites
Can continue to be used after defibrillation

Typical properties

Age Group: Adult
Brands: Red Dot™
Case Packaging: 10 ea/card, 10 card/bag, 40 bag/case
Clinical Area: Critical Care, Emergency Medical Services (EMS), Emergency Room, Intensive Care, Pediatric, Physician Office, Surgery
Clinical Sub-Area: Orthopedics
Department: Cardiac Rehab, Cath Lab, EMS/ER, ICU/CCU, OR
Electrode Size: 1.2" x 0.8"
Electrode Type: Resting
Factory ISO Certification: No ISO Certification information available
Gel Type: Conductive Adhesive
Material: Plastic Film
Model: 2330, 2360
Monitoring Event: Echo-Cardio
Package Contents: 10 ea/card, 10 card/bag, 40 bag/case
Patient: Adult
Pre-wired: No
Product Type: Electrode
Product Type Free Format: Electrode
Product Use: Resting
Radiolucency: Radiolucent
Skin Prep Included: No
Skin Type: Fragile, Normal
Solution: Resting
eClass 14 Classification Group: 34580108

Dimensions and Classifications

Overall Length (Metric): 2 cm
Overall Width (Metric): 2 cm

ECG Monitoring Cable

Details

Available for disposable or reusable ECG leadwires
Complement to the Universal System of leadwires and adapters that helps standardize almost all monitoring systems
Enables disposable leadwires to be used in multiple departments, allowing a single dispos

Typical properties

Brands: 3M™

Case Packaging: 1 each, 100 Electrode/Bag, 40 Bags/Case or 4000 Electrodes/Case, 3 Electrodes/Package; 100 Packages or 300 Electrodes/Case, 3 Electrodes/Package; 200 Packages or 600 Electrodes/Case, 5 Electrodes/Package; 200 Packages or 1000 Electrodes/Case, 50 Electrodes/Bag; 20 Bags or 1000 Electrodes/Case

Compatibility: 6-pin AAMI, AAMI/Philips Twin Pin, GE, Medtronic/Physio Control, Nihon Kohden, Safety DIN, Universal DIN

Disposable: No, Yes

Electrode Connection: Pinch, Snap

Factory ISO Certification: No ISO Certification information available

Model: AA3C10H, AA3C11, AA3C12, AA3C17, AA3C54, AA3C56, AA3C59, AA3C68-2, AA3C78-90, AA3C90, AA5C11, AA5C12, AA5C17, AA5C54, AA5C59, AA5C68, AA5C90, CBLAA3P, CBLAA5P, CBLMT3P, CBLMT3S, CBLMT5S, D3C11, D3C56, D3C56-90, D3C68, D3C78-90, D3C90, D5C11, D5C54, D5C90, F3C56, F3C68, UC3-AAMI6, YMC10DTO5, YMC10DTO6, YMC10GE55, YMC10GE64, YMC10MT55, YMC10MT64, YMC10PH64, YMC10SL64, YMC3AAMI, YMC3AAMIR, YMC3DS90, YMC3DTO, YMC3MT, YMC3NK, YMC3PH, YMC3PN8, YMC3SL, YMC5AAMIN, YMC5AAMIR, YMC5MT90, YMC5PH, YMC5PN6, YMC5PN8, YMC5SL, YMC6AAMIN, YMC6AAMIR, YMC6DTO, YMC6GE, YMC6MT, YMC6NK, YMC6PH, YMC6SL, YMDLW5SGES, YMDLW6SNKS

Monitor Brand: ATL Ultrasound 800, ATL Ultrasound 800 Plus, ATL Ultrasound Apogee, ATL Ultrasound Mark IV, ATL Ultrasound Mark VII, ATL Ultrasound Ultramark 4, ATL Ultrasound Ultramark 4 Plus, ATL Ultrasound Ultramark 5, ATL Ultrasound Ultramark 7, ATL Ultrasound Ultramark 9, Airshields HRRM-71-1, Airshields HRRM-71-2, Airshields Porta-Fib I, Airshields Porta-Fib II, Airshields Porta-Fib III, Airshields System 5, Airshields System 6, BCI (Biochem International) 3101, BCI (Biochem International) 3404, BCI (Biochem International) 6100, BCI (Biochem International) 6200, BCI (Biochem International) 9100, BCI (Biochem International) 9200, BCI (Biochem International) Advisor, BCI (Biochem International) Autocorr, Burdick (Spacelabs) Medic 3, Burdick (Spacelabs) Medic 4, Burdick (Spacelabs) Medic 5, CSI (Criticare Systems International) 504US, CSI (Criticare Systems International) 602-4USP, CSI (Criticare Systems International) Poet II, CSI (Criticare Systems International) Scholar, Colin Medical Instruments BP308, Colin Medical Instruments BP408, Colin Medical Instruments CBM3000, GE Medical Systems Corometrics 556, GE Medical Systems Critikon 8100T, GE Medical Systems Critikon Dinamap 8700 Series, GE Medical Systems Critikon Dinamap 9700

Series, Invivo Research / M.D.E. 3500, Invivo Research / M.D.E. 3550, Invivo Research / M.D.E. Millennia, Medical Data Electronics (MDE) Escort 100, Medical Data Electronics (MDE) Escort 101, Medical Data Electronics (MDE) Escort 102, Medical Data Electronics (MDE) Escort 200, Medical Data Electronics (MDE) Escort 300, Medical Data Electronics (MDE) Escort Prism, Medtronic / Physio Control Lifepak 6, Medtronic / Physio Control VSM-1ESF, Mindray P-8000, Mindray P-8000 Express, Narco (Vickers) HRRM-71-1, Narco (Vickers) HRRM-71-2, Narco (Vickers) Porta-Fib I, II, III, Narco (Vickers) System 5, Narco (Vickers) System 6, Nellcor N-1000, Nellcor N-200 C-LOCK, Nellcor N-250 C-LOCK, Nellcor NPB-3900, Nellcor NPB-4000, Nihon Kohden BSM-8301A, Nihon Kohden BSM-8302A, Nihon Kohden BSM-8500A, Nihon Kohden OEC-6102A (s/n>20156), Nihon Kohden OEC-6105A (s/n>20226), Nihon Kohden OEC-7102A, Nihon Kohden OEC-8108A, Nihon Kohden TEC-5200A (s/n>20421), Nihon Kohden TEC-7100A, Nihon Kohden TEC-7200A, Nihon Kohden TEC-7300A, Pace Tech MiniMax 4000CL, Pace Tech MiniPack 300, Pace Tech MiniPack 3000, Pace Tech MiniPack 3100, Pace Tech VitalMax 2100, Pace Tech VitalMax 2200, Pace Tech VitalMax 4000, Pace Tech VitalMax 4000 Modular, Pace Tech VitalMax 4000CL, Pace Tech VitalMax 4100, Pace Tech VitalMax 4100CL, Pace Tech VitalMax 800 Plus, Philips Medical Systems IE 33 Ultrasound, Philips Medical Systems M3921A (A1), Spacelabs Medical 400 Series, Spacelabs Medical 500 Series, Spacelabs Medical 600 Series, Spacelabs Medical 900 Series, Spacelabs Medical 90300, Spacelabs Medical 90303B, Spacelabs Medical 90305, Spacelabs Medical 90308, Spacelabs Medical 90308-11, Spacelabs Medical 90408, Spacelabs Medical 90425, Spacelabs Medical 90428, Spacelabs Medical 90431, Spacelabs Medical 90432, Spacelabs Medical 90470, Spacelabs Medical 90600A Series, Spacelabs Medical 90700, Spacelabs Medical 90700 Series, Spacelabs Medical 90701, Spacelabs Medical 90721, Spacelabs Medical 90724, Spacelabs Medical PC Bedside, Spacelabs Medical PCMS System, Spacelabs Medical TEK-208, Spacelabs Medical TEK-408, Spacelabs Medical TEK-413, Spacelabs Medical TEK-414, Spacelabs Medical TEK-511, Spacelabs Medical TEK-512, Spacelabs Medical TEK-514, Spacelabs Medical TEK-5214045 Defib, Welch Allyn Atlas, Welch Allyn Encore 202EL, Welch Allyn Encore 204EL, Welch Allyn Encore 206EL, Welch Allyn Propaq 102EL, Welch Allyn Propaq 104EL, Welch Allyn Propaq 106EL, Welch Allyn Propaq 202EL, Welch Allyn Propaq 204EL, Welch Allyn Propaq 206EL, Welch Allyn Propaq CS, Welch Allyn Protocol, Welch Allyn UltraSmart, Zoll Medical D900, Zoll Medical M Series, Zoll Medical PD1200, Zoll Medical PD1400

Number of Leads: 10, 3, 5, 6

Patient Connector: Snap

Product Type: Cable, Leadwire

Radiolucency: Radiopaque

Yoke Connection: 1 Piece Molded Cable and Leadwire, GE Grouped, Nihon Kohden Grouped, Philips/AAMI Twin-pin, Safety DIN, Universal DIN

eClass 14 Classification Group: 34090507

Dimensions and Classifications

Overall Length (Imperial): 10 ft, 50 in

**3M™ Steri-Drape™ Caesarean-Section Pack 7965P, 5 per Carton / 2
Cartons
per Case**

3M ID 7000030260 UPC 00707387563301

Details

Fluid Control Features
Resistant to Strikethrough
Impervious to Strikethrough

Typical properties

Additional Drapes: Pack
Brands: Steri-Drape™
Cladimed Code: E51AI03
Factory ISO Certification: No ISO Certification information available
Product Type: C-section Sheet
Product Use: Procedure Specific
Units per Pack: 5

3M™ Steri-Drape™ Medium Drape with Incise Film and Pouch, 1061, 130 cm x 130 cm (51 in x 51 in), 10/CTN, 4 CTN/Case

3M Product Number 1061 3M ID 7000030133 UPC 30707387074068

Details

Impervious polyethylene film provides a barrier to liquids, reducing exposure to blood and body fluids

Incise area gives complete coverage of lashes, lids, and brows for isolation of globe and incision area

Matte finish helps reduce glare from drape sur

Typical properties

Accessories: Bags and Pouches

Brands: Steri-Drape™

Factory ISO Certification: No ISO Certification information available

Features: Clear

Incise Area Length (Metric): 10 cm

Incise Area Width (Metric): 12.5 cm

Material: Plastic

Model: 1061

Procedure: EENT

Product Color: Transparent

Product Type: Drape Sheet

Product Type Free Format: Drape

Product Use: EENT

Sterile: Yes

Therapeutic Area and Conditions: Ophthalmic

Units per Pack: 10

Dimensions and Classifications

Overall Length (Imperial): 51 in

Overall Length (Metric): 130 cm

Overall Width (Imperial): 51 in

Overall Width (Metric): 130 cm

3M™ Bair Hugger™ Plus Warming Gown with Booties 83102, Small Size, 20/Case

3M ID 7100087583 UPC 50707387774627

Details

Provides comfort and clinical warming throughout perioperative process
Patient-adjustable warming
Prewarming capabilities
Accommodates adolescent and petite surgical patients
Booties can help keep patients comfortable
Full coverage, wrap-around design

Typical properties

Brands: Bair Hugger™
Clinical Area: OR, PACU, Pre-op
Closure Style: Tie Neck & Back
Factory ISO Certification: No ISO Certification information available
Gown Circumference (Metric): 140 cm
Gown Size: Small
Model: 83102
Product Type: Gown
Quantity: 20 Case
Reusable: No
Style: Plus Gown
Sweep: 55 in +/- 1
Sweep (Metric): 140
Units per Pack: 20
eClass 14 Classification Group: 34540392

Dimensions and Classifications

Overall Length (Imperial): 44 in
Overall Length (Metric): 111 cm

3M™ Bair Hugger™ Warming Blanket, 64500

3M ID B00042337

Details

Can be used in supine, prone, lithotomy and other patient positions

Typical properties

Brands: Bair Hugger™

eClass 14 Classification Group: 34540392

3M™ CoTran™ Polyethylene Backing Film, 9720, Config Roll

3M ID 7100000161

Details

Translucent
Breathable
Printable
Corona treated
Matte finish on both sides
Can be directly laminated to adhesives
Heat Sealable (PE)

Typical properties

Backing (Carrier) Material: Polyethylene
Brands: CoTran™
Breathability: Breathable
Caliper: 3 mils
Caliper (Metric): 76.2 µm
Catalog Number: 9720
Elongation CD: 150%
Elongation MD: 250%
Factory ISO Certification: No ISO Certification information available
Heat Seal Layer: Polyethylene (PE)
MVTR (g/m²/24 hr): 6
Oxygen Transmission (cc/m²/24hr): 3840
Product Color: Transparent
Product Type: Transdermal Backing
Sample Roll: 6 in x 25 yds
Sample Roll (Metric): 15 cm x 23 m
Tensile CD: 3 lbs/in
Tensile CD (Metric): 14.0 N/25.4 mm
Tensile MD: 5 lbs/in
Tensile MD (Metric): 2250 g/25 mm
eClass 14 Classification Group: 41011103

Dimensions and Classifications

Overall Length (Imperial): 2000 yd
Overall Length (Metric): 1829 m
Overall Thickness (Imperial): 3 mil
Overall Thickness (Metric): 76.2 micron
Overall Width (Imperial): 48.031 in
Overall Width (Metric): 122 cm

3M™ Kind Removal Silicone Tape, single-patient use roll 2770S-2, 2 inch x 1 1/2 yard (5cm x 1,3m)

3M ID 7000053989 UPC 30707387763641

Details

Security: Offers reliable and pliable fixation, remains in place until you decide otherwise

Comfort: Removes cleanly, without disrupting fragile skin layers or causing patients undue pain

Ease of Use: Can be repositioned and neatly torn by hand

Economi

Typical properties

Brands: 3M™

Factory ISO Certification: No ISO Certification information available

Hypoallergenic: Yes

IV Related Condition Type: CVC Dialysis, CVC PICC, PIV

Product Color: Blue

Product Type: Surgical Tape

Units per Pack: 50

Dimensions and Classifications

Overall Length (Imperial): 1.5 yd

Overall Length (Metric): 1.3 m

Overall Width (Imperial): 2 in

Overall Width (Metric): 5.08 cm

3M™ Comply™ Thermalog™ Steam Chemical Integrator, 2134MM, Cls 5, 3/4 x 4 in (1.9 x 10.16 cm), 250/PAC, 8 PAC/CS, 2000/CS

3M ID 7000053626 UPC 50707387469196

Details

Easy interpretation within seconds using moving ink technology with "UNSAFE" and "SAFE" zones

ANSI/AAMI/ISO 11140-1:2005(R)2010 compliant Class 5 Integrating Indicator

For use in all 121-135°C (250-275°F) steam sterilization cycles

Interested in the ne

Typical properties

Brands: Comply™

Catalog Number: 2134MM

Factory ISO Certification: No ISO Certification information available

Form: Wick

Inner Packs per Case: 8 Packs per Case

Product Type: Chemical Indicator

Product Type Free Format: Chemical Integrators

Product Use: Pack Monitoring

Shelf Life: 3 Year

Sterilization Method: Steam

Total Units per Case: 2000 per Case

Units per Inner Pack: 250 per Pack

eClass 14 Classification Group: 34410402

Dimensions and Classifications

Overall Length (Imperial): 4 in

Overall Length (Metric): 10.16 cm

Overall Width (Imperial): 0.75 in

Overall Width (Metric): 1.9 cm

3M™ Medical Foam Tape 9776, Single Sided Polyethylene, 72# liner, Configurable

3M ID 7100000071

Details

Acrylic Adhesive
Fluid resistant
Printable with treatment
Good Processability

Typical properties

Brands: 3M™
Catalog Number: 9776
Factory ISO Certification: No ISO Certification information available
Product Color: Tan
Product Type: Medical Tape
Tape Type: Single Sided Foam Tape
eClass 14 Classification Group: 34390202

Dimensions and Classifications

Overall Thickness (Imperial): 34 mil
Overall Thickness (Metric): 0.86 mm

3M™ Micropore™ Surgical Tape, 1530 Series

Details

Reliable adhesion: Good initial and long-term (72 hours) adhesion to skin
Tape material: Breathable paper tape not made with natural rubber latex
Can be torn by hand
Conformable
Provides multi-purpose securement for clinical applications: Blood draws,

Typical properties

Brands: Micropore™
Factory ISO Certification: No ISO Certification information available
Hypoallergenic: Yes
IV Related Condition Type: CVC Dialysis, CVC Implanted Port, CVC Tunneled, PIV
Material: Paper
Product Color: White
Product Type: Medical Tape, Surgical Tape
Units per Pack: 50 , 400 , 630 , 800

Dimensions and Classifications

Overall Length (Imperial): 1.5 yd, 10 yd
Overall Length (Metric): 1.37 m, 9.1 m
Overall Width (Imperial): 0.5 in, 1 in, 2 in, 3 in
Overall Width (Metric): 1.27 cm, 2.5 cm, 2.54 cm, 5.08 cm, 7.6 cm, 25 mm

3M™ Transpore™ Surgical Tape, 1527 Series

Details

Easy, straight, bi-directional tear
Easy to handle with gloves
Good adhesion to skin and tubing
Transparent, porous
Hypoallergenic and not made with natural rubber latex
Water resistant
Allows clinician to tailor the tape for the various dressings a

Typical properties

Brands: Transpore™
Environmental claim being made: Yes
Environmental claim relates to: Product
Evidence for Claim: Self Certified
Factory ISO Certification: No ISO Certification information available
Hypoallergenic: Yes
IV Related Condition Type: Arterial Catheter, CVC Dialysis, CVC Implanted Port, CVC PICC, CVC Short-Term, CVC Tunneled, PIV
Material: Plastic
Product Color: Transparent
Product Type: Medical Tape, Surgical Tape

Dimensions and Classifications

Overall Length (Imperial): 1.5 yd, 10 yd
Overall Length (Metric): 1.37 m, 9.1 m
Overall Width (Imperial): 0.5 in, 1 in, 2 in, 3 in, 3.75 in
Overall Width (Metric): 1.25 cm, 2.5 cm, 2.54 cm, 5 cm, 7.6 cm, 9.525 cm

3M™ Steri-Gas™ EO (ethylene oxide) Cartridges 4-134

3M ID 7100044557 UPC 50707387495515

Details

System offers easy, cost-effective and efficient sterilant for ethylene oxide sterilization

Precise usage of EO with single-dose cartridge means no sterilant waste

With Steri-Gas cartridges, operators have no bulky, heavy gas tanks to handle, and no hoses

Typical properties

Brands: Steri-Gas™

Compatibility: 5XL, 8XL, GS5, GS5X, GS8, GS8X

Factory ISO Certification: No ISO Certification information available

Industries: Life Sciences

Life Science Sterilization: Ethylene Oxide Low Temperature Sterilization

Model: 4-134

Product Type: Sterilant

Sterilization Method: Ethylene Oxide (EO)

eClass 14 Classification Group: 34419090

Gamgee Highly Absorbent Padding

3M ID B00035315 UPC 50051115052748

Details

Non-woven, low-adherent cover helps prevent bandage from sticking to wound and helps keep cotton fibers out of the wound site
Minimizes wound disruption and provides a fiber and particle barrier
Highly absorbent. Strong (even when wet) protective padding

Typical properties

Brands: Private Label
Factory ISO Certification: No ISO Certification information available
Package Contents: 1 Roll/Pack
Product Type: Absorbent Pad
eClass 14 Classification Group: 34210402

Dimensions and Classifications

Overall Length (Imperial): 7.6 ft, 11.6 ft
Overall Width (Imperial): 12 in, 18 in

3M™ Scotchcast™ Quick Step Double Sided Felt Roll Splint

Details

Felt on both sides of splint - helps eliminate the risk of wrong-side application while providing padding and protection for the patient's injury
Water-repellant technology sheds water off splint, helping keep the patient's skin dry and reduces the risk

Typical properties

Brands: Scotchcast™
Cladimed Code: M50CB02
Factory ISO Certification: No ISO Certification information available
Form: Roll
Model: 74002Q, 74003Q, 74004Q, 74005Q
Padding: Double Sided Padded
Product Type: Double Sided Felt Roll Splint
Product Use: Splinting
Units per Pack: 1
eClass 14 Classification Group: 34200204

Dimensions and Classifications

Overall Length (Imperial): 15 ft
Overall Length (Metric): 4.5 m
Overall Width (Imperial): 2 in, 3 in, 4 in, 5 in
Overall Width (Metric): 5.1 cm, 7.6 cm, 10.1 cm, 12.7 cm

3M™ Tegaderm™ CHG Chlorhexidine Gluconate I.V. Securement Dressing

Details

Only transparent dressing cleared and proven to reduce CRBSIs and vascular catheter colonization
Integrated design combines infection reduction with site visibility, catheter securement and consistent application
CHG gel pad provides immediate and conti

Typical properties

Boxes per Case: 4.0,-12345.0
Brands: Tegaderm™
Catalog Number:
1657,1657R,1658R,1659NS,1658NS,1657NS,1660R,1660,1660NS,1659,1658
Cladimed Code: E52EC1
Clinical Sub-Area: Orthopedics
Condition: I.V. Related
Department: Cardiovascular, Dialysis Center, EMERGENCY, I.V. Therapy, Intensive Care Unit, Medical-Surgical, Oncology, Operating Room-Surgery, Radiology, Urgent Care, Wound Care
Dressing Type: Film
Factory ISO Certification: No ISO Certification information available
Hypoallergenic: No
IV Related Condition Type: Arterial Catheter, CVC Dialysis, CVC Implanted Port, CVC PICC, CVC Short-Term, CVC Tunneled, Epidural Catheter, PIV
Inner Packs per Case: 4 Cartons per Case
Latex: No
Product Form: Bulk
Product Type: Securement Dressing
Product Use: Arterial Catheter, CVC, Dialysis, Epidural Catheter, PICC, PIV
Sterile: No, Yes
Total Units per Case: 100 per Case, 125 per Case, 500 per Case
Units per Case: 500.0,100.0,125.0
Units per Inner Pack: 25 per Carton
Units per Pack: 25
eClass 14 Classification Group: 34180202

Dimensions and Classifications

Overall Length (Imperial): 3.375 in, 4.5 in, 4.75 in, 6.125 in
Overall Length (Metric): 8.5 cm, 11.5 cm, 12 cm, 15.5 cm
Overall Width (Imperial): 2.75 in, 3.5 in, 4 in
Overall Width (Metric): 7 cm, 8.5 cm, 10 cm

3M™ Medical Tape 9865, Single Sided Polyethylene, 63# Liner, Configurable

3M ID 7100013845

Details

Acrylic Adhesive
Fluid Resistant
Printable
Good Processability

Typical properties

Adhesive Material: Acrylate
Adhesive Type: Acrylic/Acrylate
Backing Caliper: 3 mil
Backing Caliper (Metric): 80 Micron
Backing Material: Polyethylene
Backing Thickness (Imperial): 3 mil
Backing Thickness (Metric): 80 Micron
Brands: 3M™
Breathable: No
Conformability: High
Factory ISO Certification: No ISO Certification information available
Fluid Resistance Backing/Carrier: Yes
Hypoallergenic: No
Liner Caliper (Metric): 120 Micron
Liner Caliper (mils): 4.9 mil
Liner Color: White
Liner Material: Paper
Liner Weight: 63.0 lb.
Liner Weight (Metric): 103 g/m²
Material: Polyethylene
Maximum Length (Metric): 914 m
Maximum Width Capacity: 48 in
Maximum Width Capacity (Metric): 1220 mm
Printable Backing: Yes
Product Color: Transparent
Product Type: Polyethylene
Product Usage: Adhesion to Skin, Adhesion to Substrate
Sterilization Method: Ethylene Oxide (EO), Gamma
Tape Color: Transparent
Tape Total Caliper (Metric): 110.0 Micron
Tape Type: Single-sided Polyethylene Tape
eClass 14 Classification Group: 34180101

Dimensions and Classifications

Overall Thickness (Imperial): 5.5 mil
Overall Thickness (Metric): 0.11 mm
Overall Width (Imperial): 48 in

3M™ Tegaderm™ Superabsorber Dressing

Details

Manages high exudate - High absorbency wicks excess moisture from the wound while maintaining moisture needed for proper tissue healing. Helps prevent maceration of wound edges

Versatile - Ideal for use on wounds with moderate to high levels of exudate,

Typical properties

Brands: Tegaderm™

Factory ISO Certification: No ISO Certification information available

eClass 14 Classification Group: 34210402

Dimensions and Classifications

Overall Length (Imperial): 3.875 in, 7.875 in

Overall Length (Metric): 9.842 cm, 20 cm

Overall Width (Imperial): 3.875 in, 7.875 in, 11.75 in

Overall Width (Metric): 9.843 cm, 20 cm, 29.845 cm

3M™ Steri-Strip™ Elastic Skin Closures

3M ID B00036232

Details

Stretches with patients– Conformable, flexible material stretches with body movement

Cost savings - A low cost alternative to sutures and tissue adhesives¹

Easy on patients - Soft, nonwoven backing and breathable design

Typical properties

Brands: Steri-Strip™

Product Type: Steri-Strips

eClass 14 Classification Group: 34180306

3M™ Red Dot™ Repositionable Monitoring Electrode, 2600 Series

Details

Truly repositionable, cost saving may be realized by repositioning rather than replacing electrode
Quick-to-stick means less time wasted, and wear time up to three days means fewer electrodes used
Potential for fewer false alarms that can waste electrode

Typical properties

Age Group: Adult
Application: universally applicable
Backing Material: Comfort Straps Material
Brands: Red Dot™
Case Packaging: 3 Electrodes/Package; 200 Packages or 600 Electrodes/Case, 5 Electrodes/Package; 200 Packages or 1000 Electrodes/Case
Cladimed Code: K51FG01
Department: Cardiac Rehab, Cath Lab, EMS/ER, ICU/CCU, OR, Pediatric ICU
Electrode Size: 1.56" x 1.25"
Electrode Type: Monitoring, Pediatric, Repositionable
Factory ISO Certification: No ISO Certification information available
Gel Type: Conductive Adhesive
Material: Soft Cloth
Model: 2660-3, 2660-5, 2670-3, 2670-5
Monitoring Event: Echo-Cardio, Pediatric Monitoring, Telemetry/Holter/Event
Package Contents: 3 Electrodes/Package, 5 Electrodes/Package
Patient: Adult, Pediatric
Pre-wired: No
Product Type: Electrode
Product Type Free Format: Electrode
Product Use: Monitoring
Radiolucency: Radiolucent
Skin Prep Included: No
Skin Type: Normal
Solution: Fragile Skin, Monitoring, Pediatrics, Repositionable
Therapeutic Area and Conditions: Cardiac Monitoring, Conductive Adhesive Electrode, ECG, Repositionable Electrode
Units per Pack: 3 , 5
Wear Time: Up to Three Days
eClass 14 Classification Group: 34580108

Dimensions and Classifications

Overall Length (Imperial): 1.56 in
Overall Length (Metric): 4 cm
Overall Width (Imperial): 1.25 in
Overall Width (Metric): 3 cm

Universal Adapter

Details

3M is a trusted source for ECG monitoring accessories
Featuring Yokemate LWS® Adapters, 3M understands the unique needs of your facility
Enables disposable leadwires to be used in multiple departments, allowing a single disposable leadwire to be used thr

Typical properties

Brands: 3M™
Case Packaging: 3 Electrodes/Package; 100 Packages or 300 Electrodes/Case, 3 Electrodes/Package; 200 Packages or 600 Electrodes/Case, 5 Electrodes/Package; 200 Packages or 1000 Electrodes/Case, 50 Electrodes/Bag; 20 Bags or 1000 Electrodes/Case
Compatibility: Universal DIN
Department: Cardiac Rehab, Cath Lab, EMS/ER, ICU/CCU, OR
Disposable: No
Electrode Connection: Snap
Factory ISO Certification: No ISO Certification information available
Model: AA00SU10, YMA3DS, YMA3DTO, YMA3NK, YMA3PH, YMA3SD, YMA3SL, YMA5DS, YMA5DTO, YMA5PH, YMA5SL, YMA6GE, YMA6NK
Number of Leads: 3, 5, 6
Product Type: Adapter, Telemetry Adapter
Units per Pack: 10
Yoke Connection: Universal DIN
eClass 14 Classification Group: 34090507

3M™ Attest™ Biological Indicator Incubator, 127, 1/Case

3M ID 7100214722 UPC 00707387024796

Details

28-well incubator for use with 3M™ Attest™ Biological Indicator 1264 for Ethylene Oxide (EO)

Biological Indicator (BI) results in 24 hours

Maintains pre-set temperature to 37°C ± 2 °C

Interested in biological indicator results for ethylene oxide (EO) i

Typical properties

Biological Indicator System: Standard

Brands: Attest™

Catalog Number: 127

Factory ISO Certification: No ISO Certification information available

Incubation Period: 48 Hour

Maximum Temperature (Celsius): 37 °C

Maximum Temperature (Fahrenheit): 98.6 °F

Number of Wells: 28

Product Type: Incubator

Sterilization Method: Ethylene Oxide (EO)

Total Units per Case: 1 per Case

3M™ Steri-Drape™ Foot / Hand Pack, 7 per Carton / 2 Cartons per Case, 9054P

3M ID 7000053779 UPC 00707387568078

Details

2 OP Tapes, 4 Hand Towels, 1 Mayo Stand Cover, 1 Foot/Hand Drape, 1 Instrument Table Cover
Resistant to Strikethrough
Fluid Control Features
Large side pockets with flaps for fluid collection and control

Typical properties

Additional Drapes: Pack
Brands: Steri-Drape™
Cladimed Code: E51BG07
Factory ISO Certification: No ISO Certification information available
Product Type: Extremity Drape
Units per Pack: 7

3M™ Steri-Drape™ Shoulder Split Sheet with Pouch 9196NS, 90 IN x 102 IN, 25/CS

3M ID 7000053710 UPC 00707387561307

Details

Resistant to Strikethrough

Fluid Control Features

U-pouch collects and contains fluids to help keep patients and table dry, and to help minimize the risk of exposure to healthcare personnel

Fluid collection U-pouch helps reduce cleanup time to help im

Typical properties

Brands: Steri-Drape™

Factory ISO Certification: No ISO Certification information available

Product Type: Split Sheet

Product Use: Orthopedics

3M™ Bair Hugger™ Warming Unit, Model 67500

Details

Four distinct temperature settings featured on simple, intuitive user interface
Ergonomic hose end design allows for easy blanket insertion and a secure fit
Precise temperature delivery with high accuracy
Quick temperature response with built in safety

Typical properties

Brands: Bair Hugger™
Factory ISO Certification: No ISO Certification information available
Model Number: 675
Product Type: Warming Unit
Quantity: 1 each
eClass 14 Classification Group: 34540301

3M™ Steri-Drape™ Drape Sheet 9069NS, 36 IN x 30 IN, 300/CS

3M ID 7000053589 UPC 00707387456498

Details

Reliable 2-inch adhesive strip secures the drape to the skin
Impervious to Strikethrough
Meets flammability class 1 (CFR Title 16 Part 1610)
Fluid Control Features

Typical properties

Additional Drapes: Sheet
Brands: Steri-Drape™
Factory ISO Certification: No ISO Certification information available
Product Type: Drape Sheet
Product Use: Surgical Sheet

3M™ Steri-Drape™ Drape Sheet, 40 per Carton / 4 Cartons per Case, 9071

3M ID 7000053867 UPC 00707387581572

Details

Impervious to Strikethrough
Fluid Control Features

Typical properties

Additional Drapes: Sheet
Brands: Steri-Drape™
Cladimed Code: E51DA02
Factory ISO Certification: No ISO Certification information available
Product Color: Blue
Product Type: Drape Sheet
Product Use: Procedure Specific
Units per Pack: 40

Dimensions and Classifications

Overall Length (Metric): 97 cm
Overall Width (Metric): 97 cm

3M™ Avagard™ Foaming Instant Hand Antiseptic

Details

Kills greater than 99.999% of harmful bacteria in 15 seconds (in vitro)
Helps maintain skin condition
Latex glove and CHG compatible
3M™ Avagard™ Foaming Hand Antiseptic is a USDA Certified Biobased product
Fragrance-free

Typical properties

Active Ingredient: Ethyl Alcohol
Approved Environmental Marketing Claim (EMC): 3M™ Avagard™ Foaming Hand Antiseptic is a USDA Certified Biobased product
Brands: Avagard™
Container Volume: 2 Fluid Ounce (US), 16 Fluid Ounce (US)
Environmental claim being made: Yes
Environmental claim relates to: Product
Evidence for Claim: Externally Certified
Factory ISO Certification: No ISO Certification information available
Form: Foam
Model: 9320A, 9321A
Product Type: Hand Sanitizer
eClass 14 Classification Group: 30300401

3M™ Bair Hugger™ Warming Gown with Booties 83001, Standard, 30/Case

3M ID 7100087550 UPC 50707387774542

Details

Provides comfort and clinical warming throughout perioperative process
Patient-adjustable warming
Prewarming capabilities
Accommodates adolescent and petite surgical patients
Booties can help keep patients comfortable
Full coverage, wrap-around design

Typical properties

Brands: Bair Hugger™
Clinical Area: OR, PACU, Pre-op
Closure Style: Tie Neck & Back
Factory ISO Certification: No ISO Certification information available
Gown Size: Standard
Model: 83001
Product Type: Gown
Quantity: 30 Case
Reusable: No
Style: OR Gown
Sweep: 64 in +/- 1
Sweep (Metric): 163
eClass 14 Classification Group: 34540392

Dimensions and Classifications

Overall Length (Imperial): 51 in
Overall Length (Metric): 130 cm

3M™ Bair Hugger™ Warming Blanket, 30000

Details

Single-use full body forced-air warming blanket with excellent heat transfer
Foot drape minimizes risk of thermal injury to the feet and lower leg areas
Integrated tuck flaps at shoulders help maintain warming blanket position
Provides coverage to the

Typical properties

Application: Medical
Blanket Type: Full Body
Brands: Bair Hugger™
Cladimed Code: Non applicable
Clinical Area: PACU
Clinical Sub-Area: Post Anesthetic Care Unit
Factory ISO Certification: No ISO Certification information available
Product Type: Blanket
Quantity: 10 Case
Total Units per Case: 12 per Case
Units per Pack: 10
eClass 14 Classification Group: 34540392

Dimensions and Classifications

Overall Length (Imperial): 84 in
Overall Length (Metric): 213 cm
Overall Width (Imperial): 36 in
Overall Width (Metric): 91 cm

3M™ Bair Hugger™ Warming Blanket 31500, Multi-Access, 10/Case

3M ID 7100212574 UPC 50707387790078

Details

Single-use overbody forced-air warming blanket with excellent heat transfer
Consists of a soft, comfortable, lightweight material with natural dry rubber latex
not present as a material of construction
Integrated tuck flaps at the shoulders help maintain

Typical properties

Application: Medical
Blanket Type: Full Body
Brands: Bair Hugger™
Clinical Area: PACU
Factory ISO Certification: No ISO Certification information available
Product Type: Blanket
Total Units per Case: 10 per Case
Units per Pack: 10
eClass 14 Classification Group: 34540392

Dimensions and Classifications

Overall Length (Imperial): 84 in
Overall Length (Metric): 213 cm
Overall Width (Imperial): 36 in
Overall Width (Metric): 91 cm

3M™ Bair Hugger™ Warming Blanket, 52301

3M ID B00042309

Details

Can be used in supine, prone, lithotomy and other patient positions

Typical properties

Brands: Bair Hugger™

eClass 14 Classification Group: 34540392

3M™ Medipore™ H Soft Cloth Surgical Tape, 2860 Series

Details

Conformable: Bi-directional stretch accommodates swelling, distension and movement

Tape material: Highly breathable, perforated nonwoven soft cloth tape not made with natural rubber latex

Easy to use: Easy to tear at perforations with no scissors necess

Typical properties

Brands: Medipore™

Factory ISO Certification: No ISO Certification information available

Hypoallergenic: Yes

IV Related Condition Type: Arterial Catheter, CVC Dialysis, CVC Implanted Port, CVC PICC, CVC Short-Term, CVC Tunneled, Epidural Catheter, PICC

Material: Soft Cloth

Product Color: White

Product Type: Medical Tape, Surgical Tape

Units per Pack: 6 , 12 , 16 , 24 , 48 , 72

Dimensions and Classifications

Overall Length (Imperial): 2 yd, 10 yd

Overall Length (Metric): 1.8 m, 9.1 m

Overall Width (Imperial): 1 in, 2 in, 3 in, 4 in, 6 in, 8 in

Overall Width (Metric): 2.5 cm, 2.54 cm, 5 cm, 5.08 cm, 7.62 cm, 10.1 cm, 10.16 cm, 15.2 cm, 20.32 cm

**3M™ Medical Tape 1530MS, Microporous Rayon Nonwoven, Without
Liner, 3 IN
x 72 YD**

3M ID 7000053197 UPC 00707387007652

Details

Acrylic Adhesive
Breathable
Good Processability

Typical properties

Brands: 3M™
Factory ISO Certification: No ISO Certification information available
Hypoallergenic: No
Latex: No
eClass 14 Classification Group: 34180201

Dimensions and Classifications

Overall Width (Imperial): 48 in
Overall Width (Metric): 121.92 cm

3M™ Attest™ Rapid Ethylene Oxide Biological Indicator, 1294, Green Cap, 4 hr, 50/CAR, 4 CAR/CS, 200/CS

3M ID 7000002715 UPC 30707387470389

Details

Fast and accurate 4-hour result
ISO 11138-1:2017 and ISO 11138-2:2017 compliant
Color-coded (green cap) for quick reference and easy use
Reliably monitors all ethylene oxide (EO, EtO) sterilization cycles
Compatible with the 3M™ Attest™ Auto-reader 39

Typical properties

Biological Indicator System: Rapid
Brands: Attest™
Cap Color: Green
Catalog Number: 1294
Cladimed Code: E52IC02
Factory ISO Certification: No ISO Certification information available
Incubation Period: 4 Hour
Inner Packs per Case: 4 Cartons per Case
Product Color: Green
Product Type: Biological Indicator
Product Type Free Format: Biological Monitoring System
Product Use: Load Monitoring
Sterilization Method: Ethylene Oxide (EO)
Total Units per Case: 200 per Case
Units per Inner Pack: 50 per Carton
eClass 14 Classification Group: 34410601

3M™ Attest™ Biological Indicator Incubator, 129

3M ID 7100214719 UPC 00707387029753

Details

28-well incubator for use with 3M™ Attest™ Biological Indicator 1264 for Ethylene Oxide (EO)

Biological Indicator (BI) results in 24 hours

Maintains pre-set temperature to 37°C ± 2 °C

Interested in biological indicator results for ethylene oxide (EO) i

Typical properties

Biological Indicator System: Standard

Brands: Attest™

Catalog Number: 129

Factory ISO Certification: No ISO Certification information available

Incubation Period: 48 Hour

Maximum Temperature (Celsius): 37 °C

Maximum Temperature (Fahrenheit): 98.6 °F

Number of Wells: 28

Product Type: Incubator

Sterilization Method: Ethylene Oxide (EO)

Total Units per Case: 1 per Case

3M™ Curoc™ Disinfecting Cap for Needleless Connectors, CFF1

Details

Disinfects in 1 minute. Protects ports for up to 7 days if not removed
Twists on easily and stays securely in place on commonly used needleless connectors
Brightly colored to help clinicians verify and measure compliance
In vitro testing shows effectiveness

Typical properties

Boxes per Case: 10.0,20.0
Brands: Curoc™
Catalog Number: CFF1,CFF1-270,CFF10-250,CFF10-250R
Compatible Connector: Needleless Connectors
Condition: I.V. Related
Factory ISO Certification: No ISO Certification information available
Latex: No
Package Contents: Individuals
Product Color: Green
Product Type: Disinfecting Cap
Shelf Life: 3 Year
Units per Box: 250.0,270.0
Units per Case: 5400.0,5000.0,2500.0
eClass 14 Classification Group: 34221209

3M Vetcast Plus Veterinary Casting Tape

3M ID B00034999 UPC 50051115052731

Details

Provides superior conformability
Lightweight and has a quick set up time
Easy to use, just dip in water
Size: 4" x 4 yd
Color : White

Typical properties

Factory ISO Certification: No ISO Certification information available
Package Contents: 10 roll/case
Product Type: Veterinary Casting Tape
eClass 14 Classification Group: 34200209

Dimensions and Classifications

Overall Length (Imperial): 4 yd
Overall Length (Metric): 3.6 m
Overall Width (Imperial): 2 in, 3 in, 4 in, 5 in
Overall Width (Metric): 12.7 mm, 50 mm, 75 mm, 100 mm

Nexcare™ Gentle Paper First Aid Tape T781-2PK, Tan, 1 in x 10 yds

3M ID 70007088498 UPC 00051131227187

Details

NON-IRRITATING: Great for frequent gauze changes, and gentle on sensitive skin, this dermatologist-tested, hypoallergenic adhesive tape is made without natural rubber latex

COMFORTABLE HOLD: This highly breathable first aid paper tape allows air to circu

Typical properties

Brands: Nexcare™

Product Color: Tan

Product Type: Tape

3M™ Scotchcast™ Soft Cast Casting Tape

Details

Flexible, soft cast allows for mobility
The soft, pliable cast edges improve patient comfort
Can be used in combination with rigid fiberglass splints, as soft edges provide additional comfort

Typical properties

Application: Medical
Brands: Scotchcast™
Cladimed Code: M50AF02
Factory ISO Certification: No ISO Certification information available
Model: 82101, 82102, 82102B, 82102R, 82102U, 82103, 82103B, 82103R, 82103U, 82104, 82104R, 82104U, 82105
Product Color: Blue, Purple, Red, White
Product Type Free Format: Casting Tape, Semi Rigid Casting Tape
Product Use: Casting Tape
Therapeutic Area and Conditions: Break, Diabetic Foot Ulcer, Fracture
Units per Pack: 10
eClass 14 Classification Group: 34200209

Dimensions and Classifications

Overall Length (Imperial): 2 yd, 4 yd
Overall Length (Metric): 1.8 m, 3.6 m
Overall Width (Imperial): 1 in, 2 in, 3 in, 4 in, 5 in
Overall Width (Metric): 2.5 cm, 2.54 cm, 5.08 cm, 7.62 cm, 10.1 cm, 12.7 cm

3M™ Tegaderm™ High Performance Non-adhesive Foam Dressing

Details

Adapts to changing levels of exudate to maintain moisture balance for an optimal wound healing environment

Unique multi-layer design provides high absorbency with breathability to reduce the risk of maceration

Prevents wound bed desiccation under low le

Typical properties

Adhesive: No

Adhesive Type: Non-adhesive

Backing Material: Foam

Border: No

Boxes per Case: 4.0,6.0

Brands: Tegaderm™

Catalog Number: 90600,90602,90601,90604,90603

Cladimed Code: F51BB

Condition: Dressing & Device Securement, Pressure Ulcer, Skin Care, Wound Care

Department: Home Care, Long-Term Care, Wound Care

Dressing and Device Securement Condition Type: Skin Injuries-Allergic & Irritant Contact Dermatitis

Factory ISO Certification: No ISO Certification information available

Features: Fenestrated

Inner Packs per Case: 4 Cartons per Case, 6 Cartons per Case

Latex: No

Product Color: White

Product Type: Foam Dressing

Shape: Rectangular, Square

Therapeutic Area and Conditions: First & Second Degree Burns, Leg Ulcer, Low-Heavily Exuding Wounds, Pressure Ulcer

Total Units per Case: 30 per Case, 40 per Case

Units per Case: 40.0,30.0

Units per Inner Pack: 5 per Carton, 10 per Carton

Units per Pack: 5 , 10

Wound Care Condition Type: Venous Leg Ulcer

eClass 14 Classification Group: 34210409

Dimensions and Classifications

Overall Length (Imperial): 2 in, 3.5 in, 4 in, 8 in

Overall Length (Metric): 5 cm, 8.8 cm, 10 cm, 20 cm

Overall Width (Imperial): 2 in, 3.5 in, 4 in, 8 in

Overall Width (Metric): 5 cm, 8.8 cm, 10 cm, 20 cm

3M™ Littmann® Classic II Pediatric Stethoscope

Details

Dual-sided chestpiece with small 3.3cm diaphragm is ideal for infant patients
Versatile chestpiece design provides high acoustic sensitivity with both a floating diaphragm and open bell
Non-chill rim and diaphragm provide patient comfort
Soft-sealing e

Typical properties

Application: Patient Monitoring, Physical Assessment and Blood Pressure, Physical Assessment and Diagnosis
Approved Environmental Marketing Claim (EMC): 3M™ Littmann® tubing does not contain phthalate plasticizers. It improves resistance to skin oils and alcohol, and is less likely to pick up stains.
Binaural Construction: Single lumen
Brands: Littmann®
Chestpiece Color: Rainbow, Silver
Chestpiece Finish: Machined Stainless Steel
Chestpiece Size: 1 Inch / 2.5 cm, 1.31 Inch / 3.3 cm
Chestpiece Technology: Double-sided
Chestpiece Weight: 1.4 Ounce
Chestpiece Weight (Metric): 40 g
Cladimed Code: K50BE01
Diaphragm Diameter (Imperial): 1.31 in
Diaphragm Diameter (Metric): 3.3 cm
Diaphragm Material: Epoxy/Fiberglass
Diaphragm Shape: Round
Diaphragm Type: Floating Diaphragm
Eartip Type: Soft Sealing
Environmental claim being made: Yes
Environmental claim relates to: Product
Evidence for Claim: Self Certified
Extra Eartips: No
Factory ISO Certification: No ISO Certification information available
Headset Material: Anodized Aluminum
Model: Pediatric
Net Weight (Imperial): 0.24 lb
Net Weight (Metric): 105 g
Occupation: NICU Nurse, Nurse, Pediatrician
Patient: Infant, Neonatal, Pediatric
Performance: 7
Product Type: Stethoscope
Small Diaphragm Diameter: 1 in
Small Diaphragm Diameter (Metric): 2.5 cm
Special Adaptors: No
Tube Color: Black, Caribbean Blue, Raspberry, Red
Tube Construction: Single lumen
Tunable Diaphragm: No

Units per Pack: 1
Warranty Period: 3 yr
eClass 14 Classification Group: 34340191

Dimensions and Classifications

Overall Length (Imperial): 28 in
Overall Length (Metric): 71 cm

Stethoscope Nonchill Bell Sleeve

Details

Allows for easy replacement of nonchill bell sleeve

Typical properties

Brands: Littmann®

Cladimed Code: K50BE02

Factory ISO Certification: No ISO Certification information available

Model: Infant, Pediatric

Product Color: Black, Gray

Units per Pack: 5

eClass 14 Classification Group: 34340191

**3M™ Tegaderm™ CHG Chlorhexidine Gluconate Gel Pad, 1664, 1.94
in x 2.44
in, 25/CAR, 4 CAR/CS, 100/CS**

3M ID 7100221076 UPC 00707387791391

Details

Standalone CHG gel pad engineered for versatility and antimicrobial protection
Tegaderm™ CHG is intended to reduce catheter-related bloodstream infections
(CRBSIs) in patients with central venous or arterial catheters
CHG gel pad provides immediate and

Typical properties

Boxes per Case: 4.0
Brands: Tegaderm™
Catalog Number: 1664
Condition: I.V. Related
Department: Cardiovascular, Dialysis Center, EMERGENCY, I.V. Therapy,
Intensive Care Unit, Medical-Surgical, Oncology, Operating Room-Surgery,
Radiology, Urgent Care
Dressing Type: Film
Factory ISO Certification: No ISO Certification information available
IV Related Condition Type: CVC Dialysis, CVC Implanted Port, CVC PICC, CVC
Short-Term, CVC Tunneled, PICC
Inner Packs per Case: 4 Cartons per Case
Latex: No
Product Type: Antimicrobial Dressing
Sterile: Yes
Total Units per Case: 100 per Case
Units per Case: 100.0
Units per Inner Pack: 25 per Carton
Units per Pack: 25
eClass 14 Classification Group: 34180202

Dimensions and Classifications

Overall Length (Imperial): 2.44 in
Overall Length (Metric): 6.2 cm
Overall Width (Imperial): 1.94 in
Overall Width (Metric): 4.9 cm

3M™ Red Dot™ Monitoring Electrode with Foam Tape and Sticky Gel, 2500 Series

Details

Clinically tested for a five-day wear time
High performance adhesive offers instant adhesion and up to five-day wear with excellent patient skin care and comfort
Sticky gel delivers excellent trace quality resulting in better patient information
Smalle

Typical properties

Age Group: Adult
Application: Intensive
Backing Material: Foam
Brands: Red Dot™
Case Packaging: 3 Electrodes/Package; 200 Packages or 600 Electrodes/Case, 5 Electrodes/Package; 200 Packages or 1000 Electrodes/Case, 50 Electrodes/Bag; 20 Bags or 1000 Electrodes/Case
Cladimed Code: K51FG01
Department: Cardiac Rehab, Cath Lab, EMS/ER, ICU/CCU, OR
Electrode Size: 1.60" x 1.36"
Electrode Type: Diaphoretic, Fluid Resistant, Monitoring
Factory ISO Certification: No ISO Certification information available
Gel Type: Sticky
Material: Foam
Model: 2560, 2570, 2570-3, 2570-5
Monitoring Event: Echo-Cardio, Stress Test, Telemetry/Holter/Event
Package Contents: 3 Electrodes/Package, 5 Electrodes/Package, 50 Electrodes/Bulk Bag
Patient: Adult
Pre-wired: No
Product Type: Electrode
Product Type Free Format: Electrode
Product Use: Diaphoretic, Monitoring
Radiolucency: Radiolucent, Radiopaque
Skin Prep Included: No
Skin Type: Normal
Solution: Fluid Resistant, Monitoring, Standardization, Value Price
Therapeutic Area and Conditions: Diaphoretic, Holter Monitoring, Multipurpose Electrode, Radiolucent
Units per Pack: 3 , 5 , 50
Wear Time: Up to Five Days
eClass 14 Classification Group: 34580108

Dimensions and Classifications

Overall Length (Imperial): 1.36 in, 1.56 in
Overall Length (Metric): 3.5 cm
Overall Width (Imperial): 1.38 in, 1.6 in

3M™ Red Dot™ Pre-Wired Electrode, 2200 Series

Details

This neonatal, radiolucent, monitoring electrode features pre-attached lead wires and clear tape backing

Clear tape backing allows for easy viewing of patient's skin condition

Conductive adhesive provides excellent trace quality for reliable results

CI

Typical properties

Age Group: Adult, Neonatal

Backing Material: Transparent Film

Brands: Red Dot™

Case Packaging: 3 Electrodes/Package; 100 Packages or 300 Electrodes/Case, 50 Electrodes/Bag; 20 Bags or 1000 Electrodes/Case

Cladimed Code: K51FG01

Department: Cardiac Rehab, Cath Lab, EMS/ER, ICU/CCU, NICU, OR, Pediatric ICU

Electrode Size: 0.9" x 0.7", 0.9" x 0.9", 1.25" x 0.75", 1.3" x 0.9", 1.57" x 1.0"

Electrode Type: Fluid Resistant, Infant Pre-wired, Monitoring, Neonatal Pre-wired, Pre-wired

Factory ISO Certification: No ISO Certification information available

Gel Type: Conductive Adhesive

Material: Clear Tape, Soft Cloth

Model: 2269T, 2280, 2282, 2282L, 2283, 2284, 2289PA, 2289PAL, 2289T

Monitoring Event: Echo-Cardio, Pediatric Monitoring

Package Contents: 3 Electrodes/Package, 5 Electrodes/Package

Patient: Adult, Neonatal, Pediatric

Pre-wired: Yes

Product Type: Disposable Leadwire, Electrode

Product Type Free Format: Electrode

Product Use: Monitoring

Radiolucency: Radiolucent, Radiopaque

Skin Prep Included: No

Skin Type: Fragile, Normal

Solution: Fluid Resistant, Monitoring, Pediatrics, Pre-wired

Therapeutic Area and Conditions: Neonatal Electrode, Prewired Electrode, SCBU

Units per Pack: 3

Wear Time: Up to Three Days

eClass 14 Classification Group: 34580108

Dimensions and Classifications

Overall Length (Imperial): 0.75 in, 0.9 in, 1 in, 1.3 in

Overall Length (Metric): 2.2 cm, 2.3 cm, 2.6 cm, 3.3 cm, 4 cm

Overall Width (Imperial): 0.7 in, 0.9 in, 1.25 in, 1.57 in

Overall Width (Metric): 1.8 cm, 1.9 cm, 2.2 cm, 2.3 cm, 4 cm

ECG Disposable Leadwire

Details

Offered as part of a broader disposable leadwire solution when used in conjunction with Yokemate LWS® Cable and Adapter Leadwire System
Yokemate LWS® Cable and Adapter Leadwire System allows for standardization between hospital departments and monitoring

Typical properties

Brands: 3M™

Case Packaging: 100 Electrode/Bag, 40 Bags/Case or 4000 Electrodes/Case, 3 Electrodes/Package; 200 Packages or 600 Electrodes/Case, 5

Electrodes/Package; 200 Packages or 1000 Electrodes/Case, 50

Electrodes/Bag; 20 Bags or 1000 Electrodes/Case

Compatibility: DataScope TelePaK, GE, GE Apex Pro FH, Nihon Kohden, Philips, Philips Telemetry/Universal DIN, Universal DIN

Disposable: No, Yes

Electrode Connection: Pinch, Snap

Factory ISO Certification: No ISO Certification information available

Model: YMA5GE, YMA5GET, YMA5PHT, YMA5SD-MP, YMA5SLT, YMC10PH55, YMC10SL55, YMC3GE, YMC5GE, YMDLW3P, YMDLW3SDSP, YMDLW3SDSS, YMDLW4SV, YMDLW5GEPT, YMDLW5S, YMDLW5SDSP, YMDLW5SDSS, YMDLW5SGEP, YMDLW5SS, YMDLW5SV, YMDLW5SVP, YMDLW6S, YMDLW6SGEP, YMDLW6SGES, YMDLW6SNKP, YMDLW6SP, YMDLW6SP-T, YMDLW6SS, YMDLWS4SV

Number of Leads: 10, 3, 4, 5, 6

Patient Connector: Pinch, Snap

Product Type: Cable, Leadwire, Telemetry Adapter

Radiolucency: Radiopaque

Yoke Connection: DataScope TelePaK Grouped, GE Grouped, Nihon Kohden Grouped, Phillips Telemetry / Universal DIN with Shower Shield, Universal DIN
eClass 14 Classification Group: 34090507

Dimensions and Classifications

Overall Length (Imperial): 10 ft, 30 in, 50 in

3M™ Littmann® CORE Digital Stethoscope

Details

Connects to Eko software to visualize and share heart sound waveforms
Up to 40x amplification (at peak frequency, vs. analog mode)
Active noise cancellation reduces unwanted background sounds
Toggle between analog and amplified listening modes
Soft-se

Typical properties

Application: Cardiology/High Performance, Diagnostic Auscultation, Patient Monitoring, Physical Assessment and Blood Pressure, Physical Assessment and Diagnosis, Recording & Sharing, Sound Amplification
Binaural Construction: Double Lumen
Brands: Littmann®
Catalog Number: 8870,8863,8869,8570,8890,8480
Chestpiece Color: Black, Copper, High Polish Mirror, Rainbow
Chestpiece Diameter (Imperial): 1.7 in
Chestpiece Diameter (Metric): 4.3 cm
Chestpiece Finish: High Polish, Machined Stainless Steel, Matte, Mirror
Chestpiece Size: 1.3 Inch / 3.3 cm, 1.7 Inch / 4.3 cm
Chestpiece Technology: Double-sided
Chestpiece Weight: 3.1 Ounce
Chestpiece Weight (Metric): 87 g
Diaphragm Diameter (Imperial): 1.7 in
Diaphragm Diameter (Metric): 4.3 cm
Diaphragm Material: Epoxy/Fiberglass
Diaphragm Shape: Round
Diaphragm Type: Digital Electronic Filtering - Ambient Noise Reduction (ANR), Tunable, single-piece
Eartip Type: Soft Sealing
Extra Eartips: Yes
Factory ISO Certification: No ISO Certification information available
Headset Finish: Black
Headset Material: Anodized Aluminum
Model: CORE
Net Weight (Imperial): 8.1 oz
Net Weight (Metric): 232 g
Occupation: Advanced Registered Practice Nurse, Anesthesiologist, Cardiologist, Critical Care Nurse, EMT/EMS, Emergency Physician, Family Practitioner, Gastroenterologist, Hospitalist, Intensivist, Internist, Medical Student, Nurse, Obstetrician, Osteopath, Pediatrician, Physician, Physician Assistant, Pulmonologist, Respiratory Specialist, Teacher/Professor/Instructor, Veterinarian
Patient: Adult, Infant, Neonatal, Pediatric
Performance: 10, 10+
Small Diaphragm Diameter: 1.3 in
Small Diaphragm Diameter (Metric): 3.3 cm
Special Adaptors: No
Tube Color: Black

Tube Construction: Double Lumen
Tunable Diaphragm: Yes
Warranty Period: 2 yr
eClass 14 Classification Group: 34340191

Dimensions and Classifications

Overall Length (Imperial): 27 in
Overall Length (Metric): 69 cm, 685.8 mm

**3M™ Littmann® Diaphragm for Littmann® Electronic Model 3100
Stethoscope,
Gray**

3M ID 7100009128 UPC 0070738777364

Details

Allows for easy replacement of diaphragm
Standard diaphragm designed to listen to the higher-frequency sounds
Available in sizes to fit Littmann® stethoscope models that feature a standard floating diaphragm (non-tunable)

Typical properties

Brands: Littmann®
Factory ISO Certification: No ISO Certification information available
Product Color: Gray
eClass 14 Classification Group: 34340191

DERMATAC™ Drape, DTAC10LDP, 10/pk

3M ID 7100242821 UPC 00849554005242

Details

Conforms easily to the dressing location and can be repositioned after initial placement

Saves time with quicker dressing changes compared to traditional 3M™ V.A.C.® drapes (1) (2)

Ensures the stability of the seal required for negative pressure

Increa

Typical properties

Brands: Dermatac™

Factory ISO Certification: No ISO Certification information available

eClass 14 Classification Group: 34210701

PREVENA PLUS™ CUSTOMIZABLE™ System Kit, PRE4001US, 7 day pump, 1/ea

3M ID 7100237246

Details

The 3M™ Prevena™ Plus Customizable Incision Management System Kit is designed for flexibility with a customizable dressing for linear, non-linear and intersecting incisions up to 90cm in length

The 3M™ Prevena™ Plus 125 Therapy Unit provides pre-set, con

Typical properties

Brands: Prevena™

Factory ISO Certification: No ISO Certification information available

Product Type: 7-day Pump

Dimensions and Classifications

Overall Length (Imperial): 35.433 in

Overall Length (Metric): 90 cm

Overall Width (Imperial): 0.709 in

Overall Width (Metric): 1.8 cm

V.A.C. VERAFLU CLEANSE™ Dressing, ULTVCL05MD, Medium, 5/pk

3M ID 7100238227 UPC 00849554001329

Details

Ideal for addressing wounds with complex geometries (eg. Tunnels, undermining and circumferential applications)
Tubular coiled foam (61 x 3.2 cm diameter)
One size

Typical properties

Brands: Veraflo™
Catalog Number: ULTVCL05MD
Factory ISO Certification: No ISO Certification information available
Size: Medium
Total Units per Case: 5 per Case
eClass 14 Classification Group: 34210701

Dimensions and Classifications

Overall Length (Metric): 3.2 cm
Overall Width (Metric): 61 cm

3M™ V.A.C. Veralink™ Cassette

3M ID B5005265169

Details

Enables use of 3M™ Veraflo™ Therapy with the 3M™ V.A.C.® Ultra Therapy System
Includes 38mm Spikeable Cap Adapter

Typical properties

Brands: V.A.C. Veralink™
Factory ISO Certification: No ISO Certification information available
eClass 14 Classification Group: 34210701

3M™ ActiV.A.C.™ Therapy System with iOn Progress™ Remote Therapy Monitoring

3M ID B5005265183

Details

Adds only 0.2 lbs to the overall unit weight, not requiring an additional system to manage

Accesses data within the device, requiring no additional tracking for the patient

Data is transferred through HIPAA-compliant secure connection, minimizing privacy

Typical properties

Brands: ActiV.A.C.™

eClass 14 Classification Group: 34210701

3M™ V.A.C.® Rx4 Therapy Unit

3M ID B5005265196

Details

Developed in partnership with the U.S. Military
3M™ V.A.C.® Rx4 Therapy Unit provides the power to multi-task wound care
500 mL or 1000 mL 3M™ V.A.C.® Canisters

Typical properties

Brands: V.A.C.®
eClass 14 Classification Group: 34210701

3M™ Steri-Drape™ Craniotomy Pack with Ioban™ 2 Incise Film, 7 per Case, 6687 P

3M ID 7000053850 UPC 00707387579593

Details

Superior Strength and Comfort
Fluid Control Features
Resistant to Strikethrough

Typical properties

Additional Drapes: Pack
Brands: Steri-Drape™
Cladimed Code: E51AA01
Factory ISO Certification: No ISO Certification information available
Incise Area Width (Metric): 32 cm
Material: Fabric
Model: 6687
Product Type: Incise Drapes
Product Use: Procedure Specific
Units per Pack: 10

Dimensions and Classifications

Overall Length (Metric): 196 cm

**3M™ Steri-Drape™ Extremity Drape 9053NS, 90 IN x 118 IN, aperture 2
1/4
IN x 3 1/8 IN, 18/CS**

3M ID 7100045699 UPC 00707387456399

Details

Superior Strength and Comfort
Impervious to Strikethrough
Fluid Control Features

Typical properties

Brands: Steri-Drape™
Factory ISO Certification: No ISO Certification information available
Product Type: Extremity Drape
Product Use: Orthopedics

Dimensions and Classifications

Overall Length (Metric): 300 cm
Overall Width (Metric): 228 cm

**3M™ Steri-Drape™ Adhesive Split Sheet, 9055, 300 cm x 353 cm,
8/Cartron,
2/Case**

3M ID 7000002826 UPC 30707387565542

Details

Resistant to Strikethrough
Large side pockets with flaps for fluid collection and control
Remove - Duplicate

Typical properties

Brands: Steri-Drape™
Cladimed Code: E51BG05
Factory ISO Certification: No ISO Certification information available
Loophole Length (Metric): 19 cm
Loophole Width (Metric): 19 cm
Material: Fabric, Plastic
Model: 9055
Procedure: Orthopedic
Product Color: Blue
Product Type: Hip Drape
Product Type Free Format: Drape
Product Use: Orthopedics
Therapeutic Area and Conditions: Orthopaedic
Units per Pack: 8

Dimensions and Classifications

Overall Length (Imperial): 118 in
Overall Length (Metric): 300 cm
Overall Width (Imperial): 139 in
Overall Width (Metric): 353 cm

3M™ Steri-Drape™ Adhesive Split Sheet, 9196, 228 cm x 260 cm, 10/Case, 2/Case

3M ID 7000002777 UPC 30707387560400

Details

Resistant to Strikethrough

Fluid Control Features

U-pouch collects and contains fluids to help keep patients and table dry, and to help minimize the risk of exposure to healthcare personnel

Fluid collection U-pouch helps reduce cleanup time to help imp

Typical properties

Brands: Steri-Drape™

Factory ISO Certification: No ISO Certification information available

Material: Fabric, Plastic

Model: 9196

Procedure: Orthopedic

Product Type: Split Sheet

Product Type Free Format: Drape

Product Use: Orthopedics

Therapeutic Area and Conditions: Orthopaedic

Units per Pack: 10

Dimensions and Classifications

Overall Length (Imperial): 102 in

Overall Length (Metric): 260 cm

Overall Width (Imperial): 90 in

Overall Width (Metric): 228 cm

3M™ Steri-Drape™ Adhesive Split Sheet 9043

3M ID 7000053578 UPC 50707387456264

Details

Resistant to Strikethrough
Reliable, dependable adhesive
Fluid Control Features
Low linting (INDA IST 160.1-83)
Meets flammability class 1 (CFR Title 16 Part 1610)
Absorbs spills and splatters
Reliable adhesive strip stays secure throughout the proc

Typical properties

Accessories: Miscellaneous
Brands: Steri-Drape™
Cladimed Code: E51BA99
Factory ISO Certification: No ISO Certification information available
Loophole Length (Metric): 7 cm
Loophole Width (Metric): 70 cm
Material: Fabric
Model: 9043
Procedure: Neurology, Orthopedic
Product Color: Blue
Product Type: Split Sheet
Product Type Free Format: Drape
Product Use: Surgical Sheet
Therapeutic Area and Conditions: Orthopaedic
Units per Pack: 30

Dimensions and Classifications

Overall Length (Imperial): 60 in
Overall Length (Metric): 152 cm
Overall Width (Imperial): 72 in
Overall Width (Metric): 183 cm

3M™ Steri-Drape™ Adhesive Split Sheet 9044NS Non-sterile

3M ID 7000053580 UPC 00707387456290

Details

- Resistant to Strikethrough
- Reliable, dependable adhesive
- Fluid Control Features
- Low linting (INDA IST 160.1-83)
- Meets flammability class 1 (CFR Title 16 Part 1610)
- Absorbs spills and splatters
- Reliable adhesive strip stays secure throughout the pro

Typical properties

- Additional Drapes: Sheet
- Brands: Steri-Drape™
- Cladimed Code: E51BA99
- Factory ISO Certification: No ISO Certification information available
- Product Type: Split Sheet
- Product Use: Surgical Sheet

Dimensions and Classifications

- Overall Length (Metric): 250 cm
- Overall Width (Metric): 152 cm

3M™ Steri-Drape™ Adhesive Split Sheet 9045NS Non-sterile

3M ID 7000053581 UPC 00707387456313

Details

- Resistant to Strikethrough
- Reliable, dependable adhesive
- Fluid Control Features
- Low linting (INDA IST 160.1-83)
- Meets flammability class 1 (CFR Title 16 Part 1610)
- Absorbs spills and splatters
- Reliable adhesive strip stays secure throughout the proc

Typical properties

- Additional Drapes: Sheet
- Brands: Steri-Drape™
- Cladimed Code: E51BA99
- Factory ISO Certification: No ISO Certification information available
- Product Type: Split Sheet
- Product Use: Surgical Sheet

Dimensions and Classifications

- Overall Length (Metric): 260 cm
- Overall Width (Metric): 228 cm

3M™ Steri-Drape™ Adhesive Split Sheet 9044

3M ID 7000030185 UPC 50707387456288

Details

- Resistant to Strikethrough
- Reliable, dependable adhesive
- Fluid Control Features
- Low linting (INDA IST 160.1-83)
- Meets flammability class 1 (CFR Title 16 Part 1610)
- Absorbs spills and splatters
- Reliable adhesive strip stays secure throughout the proc

Typical properties

- Additional Drapes: Sheet
- Brands: Steri-Drape™
- Cladimed Code: E51BA99
- Factory ISO Certification: No ISO Certification information available
- Loophole Length (Metric): 7 cm
- Loophole Width (Metric): 70 cm
- Material: Plastic
- Model: 9044
- Procedure: Neurology, Orthopedic
- Product Color: Blue
- Product Type: Split Sheet
- Product Type Free Format: Drape
- Product Use: Surgical Sheet
- Therapeutic Area and Conditions: Orthopaedic
- Units per Pack: 25

Dimensions and Classifications

- Overall Length (Imperial): 60 in
- Overall Length (Metric): 152 cm
- Overall Width (Imperial): 98 in
- Overall Width (Metric): 250 cm

3M™ Steri-Drape™ Adhesive Split Sheet 9045

3M ID 7000002687 UPC 50707387456301

Details

Resistant to Strikethrough
Reliable, dependable adhesive
Fluid Control Features
Low linting (INDA IST 160.1-83)
Meets flammability class 1 (CFR Title 16 Part 1610)
Absorbs spills and splatters
Reliable adhesive strip stays secure throughout the proc

Typical properties

Accessories: Miscellaneous
Brands: Steri-Drape™
Cladimed Code: E51BA99
Factory ISO Certification: No ISO Certification information available
Loophole Length (Metric): 20 cm
Loophole Width (Metric): 100 cm
Material: Fabric
Model: 9045
Procedure: Orthopedic
Product Color: Blue
Product Type: Split Sheet
Product Type Free Format: Drape
Product Use: Surgical Sheet
Sterile: Yes
Therapeutic Area and Conditions: Orthopaedic
Units per Pack: 15

Dimensions and Classifications

Overall Length (Imperial): 90 in
Overall Length (Metric): 228 cm
Overall Width (Imperial): 102 in
Overall Width (Metric): 260 cm

3M™ Steri-Drape™ Adhesive Split Sheet, 1094, 226 cm x 320 cm, 20/Case

3M ID 7000030161 UPC 50707387032901

Details

Elastomeric aperture isolates the operative site at the knee
Pouch can be adhered to the skin according to surgeon's preference
Exit port provides easy drainage of fluids
Malleable metal wire keeps the pouch open for optimal fluid collection
1007 and

Typical properties

Brands: Steri-Drape™
Cladimed Code: E51BG02
Factory ISO Certification: No ISO Certification information available
Material: Fabric
Model: 1094
Procedure: Orthopedic
Product Type: Arthroscopy Sheet
Product Type Free Format: Drape
Product Use: Orthopedics
Therapeutic Area and Conditions: Orthopaedic
Units per Pack: 20

Dimensions and Classifications

Overall Length (Imperial): 125 in
Overall Length (Metric): 317.5 cm
Overall Width (Imperial): 89 in
Overall Width (Metric): 226 cm

**3M™ Steri-Drape™ Adhesive Split Sheet, Bilateral, 183cm x 200cm, 14
per
Carton / 2 Cartons per Case, 9046L**

3M ID 7000053966 UPC 00707387763381

Details

Resistant to Strikethrough

Reliable, dependable adhesive

Fluid Control Features

Reliable, dependable adhesive (around aperture, etc.) stays secure throughout the procedure

Typical properties

Additional Drapes: Sheet

Brands: Steri-Drape™

Factory ISO Certification: No ISO Certification information available

Product Type: Split Sheet

Units per Pack: 14

Dimensions and Classifications

Overall Length (Metric): 200 cm

Overall Width (Metric): 183 cm

3M™ Steri-Drape™ Adhesive Split Sheet, 9054, 195 cm x 300 cm, 12/Case, 2/Case

3M ID 7000053738 UPC 30707387560387

Details

Superior Strength and Comfort
Impervious to Strikethrough
Fluid Control Features

Typical properties

Brands: Steri-Drape™
Cladimed Code: E51BG07
Factory ISO Certification: No ISO Certification information available
Loophole Length (Metric): 3 cm
Model: 9054
Procedure: General Surgery, Orthopedic
Product Type: Foot/Hand Drape
Product Type Free Format: Drape
Product Use: Orthopedics
Therapeutic Area and Conditions: General Surgery, Orthopaedic
Units per Pack: 12

Dimensions and Classifications

Overall Length (Imperial): 76 in
Overall Length (Metric): 195 cm
Overall Width (Imperial): 118 in
Overall Width (Metric): 300 cm

3M™ Steri-Drape™ Cardio/Chest Drape with Ioban™ 2 Incise Film 6682

3M ID 7000030283 UPC 00707387568146

Details

Designed with continuous broad-spectrum antimicrobial activity in the drape adhesive where it can't be washed away
Clinically shown to help reduce the risk of wound contamination and immobilize bacteria on the skin^{1,2}
C

Typical properties

Brands: Steri-Drape™
Factory ISO Certification: No ISO Certification information available
Features: Antimicrobial
Incise Area Length (Metric): 78 cm
Incise Area Width (Metric): 43 cm
Material: Fabric, Plastic
Model: 6682
Procedure: Cardiovascular
Product Type: Cardio Chest Drape
Product Type Free Format: Drape
Product Use: Cardiovascular
Therapeutic Area and Conditions: Cardiovascular
Units per Pack: 8

Dimensions and Classifications

Overall Length (Imperial): 78 in
Overall Length (Metric): 200 cm
Overall Width (Imperial): 128 in
Overall Width (Metric): 325 cm

3M™ Cavilon™ No Sting Barrier Film

Details

Unique – The original and only terpolymer-based alcohol-free barrier film* that helps prevent skin damage before it occurs *Of leading competitors in the market, based on disclosed ingredient information
Proven – Supported by more evidence than any other

Typical properties

Boxes per Case: 25.0,4.0,8.0

Brands: Cavilon™

Catalog Number:

334K,3345,3344,3343P,3343,3345P,3342,3343N,3343K,3345N

Cladimed Code: A57ED

Condition: Dressing & Device Securement, I.V. Related, Pressure Ulcer, Skin Care, Wound Care

Delivery System: Wand, Wipe

Department: Cardiovascular, Critical Care, Dialysis Center, EMERGENCY, Home Care, I.V. Therapy, Intensive Care Unit, Labor & Delivery, Long-Term Care, Medical-Surgical, Oncology, Operating Room-Surgery, Orthopedics, Pediatrics, Radiology, Urgent Care, Wound Care

Dressing and Device Securement Condition Type: Adhesive Trauma, Skin Injuries-Allergic & Irritant Contact Dermatitis, Skin Injuries-Maceration, Skin Injuries-Mechanical, Surgical Wound, Tube & Device Securement-Infusion & Monitoring, Tube & Device Securement-Lightweight Tubes & Devices

Factory ISO Certification: No ISO Certification information available

Hypoallergenic: Yes

IV Related Condition Type: Arterial Catheter, CVC Dialysis, CVC Implanted Port, CVC PICC, CVC Short-Term, CVC Tunneled, Epidural Catheter, PIV

Inner Packs per Case: 4 Cartons per Case

Latex: No

Product Color: Transparent

Product Form: Packet

Product Type: Barrier Film

Total Units per Case: 100 per Case

Units per Case: 200.0,400.0,120.0,100.0

Units per Inner Pack: 25 per Carton

Units per Pack: 5 , 12 , 25 , 30 , 50 , 100

Volume (Imperial): 0.025 fl oz, 0.034 fl oz, 0.035 fl oz, 0.101 fl oz

Volume (Metric): 0.75 mL, 1 mL, 3 mL

eClass 14 Classification Group: 40290501

3M™ Avagard™ D Instant Hand Antiseptic with Moisturizers

Details

Broad-spectrum activity kills 99.999% of harmful bacteria, including antibiotic-resistant strains (in vitro)
Proven efficacy - meets CDC, AORN and WHO Guidelines
Helps prevent skin breakdown
Dries quickly without leaving hands sticky
Compatible with C

Typical properties

Active Ingredient: Ethyl Alcohol
Brands: Avagard™
Container Volume: 3 Fluid Ounce (US), 16 Fluid Ounce (US), 33 Fluid Ounce (US)
Factory ISO Certification: No ISO Certification information available
Model: 9221, 9222, 9230
Product Type: Hand Sanitizer
Product Use: Nail Cleaner
eClass 14 Classification Group: 30300401

3M Clear Custom Collar

3M ID B00042057 UPC 50051115053394

Details

Clear plastic is made of durable, lightweight material
Scotchmate Hook and Look Fastener system allows easy application, easy removal and reapplication
Padded neck edge on collar provides a comfortable fit for the patient
Available in multiple sizes

Typical properties

Factory ISO Certification: No ISO Certification information available
Package Contents: 10 each/box
Product Type: Custom Collar

3M™ Bair Hugger™ Warming Gown

Details

Provides comfort and clinical warming throughout perioperative process
Patient-adjustable warming
Prewarming capabilities
Full coverage, wrap-around design
Clinically flexible
Convenient
Easy-to-use

Typical properties

Brands: Bair Hugger™
Clinical Area: OR, PACU, Pre-op
Factory ISO Certification: No ISO Certification information available
Model: 81001, 81201
Product Type: Gown
Quantity: 20 Case, 30 Case
Size: Small, Standard, X-Large
Style: OR Gown
Sweep: 122 in +/- 1, 64 in +/- 1
Sweep (Metric): 140 , 163 , 310
eClass 14 Classification Group: 34540392

Dimensions and Classifications

Overall Length (Imperial): 51 in
Overall Length (Metric): 130 cm

3M™ Bair Hugger™ Warming Blanket 61000, Full Body Surgical, 10/Case

3M ID 7100212577 UPC 50707387790214

Details

Can be used in supine, prone, lithotomy and other patient positions
Foot drape minimizes risk of thermal injury to the feet and lower leg area
Six convenient access panels allow for quick access to the patient's chest, arms and lower body
Integrated ad

Typical properties

Application: Medical
Blanket Type: Full Body
Brands: Bair Hugger™
Clinical Area: OR
Factory ISO Certification: No ISO Certification information available
Product Type: Blanket
Quantity: 10 Case
Total Units per Case: 10 per Case
Units per Pack: 10
eClass 14 Classification Group: 34540392

Dimensions and Classifications

Overall Length (Imperial): 72 in
Overall Length (Metric): 183 cm
Overall Width (Imperial): 36 in
Overall Width (Metric): 91 cm

3M™ Cavilon™ Durable Barrier Cream

Details

Moisturizes at-risk dry skin

Unique 3M polymer technology provides breathable, low dermatitis potential, non-irritating, long-lasting moisture barrier protection that is gentle to the skin

Resists wash-off, eliminating the need for frequent reapplicatio

Typical properties

Brands: Cavilon™

Cladimed Code: A57ED

Condition: Incontinence Care, Skin Care

Container Volume: 1 Ounce

Delivery System: Tube

Department: Home Care, Long-Term Care, Wound Care

Dressing and Device Securement Condition Type: Adhesive Trauma, Skin Injuries-Allergic & Irritant Contact Dermatitis, Skin Injuries-Maceration, Skin Injuries-Mechanical, Surgical Wound, Tube & Device Securement-Infusion & Monitoring, Tube & Device Securement-Lightweight Tubes & Devices

Factory ISO Certification: No ISO Certification information available

Fragrance: No

Hypoallergenic: Yes

Latex: No

Product Form: Tube

Product Type: Barrier Cream, Skin Care

Units per Pack: 12

Volume (Imperial): 1 fl oz

Volume (Metric): 28 mL, 92 mL

eClass 14 Classification Group: 40290501

3M™ Durapore™ Surgical Tape

Details

Strong adhesion: Good initial adhesion

Tape material: Silk-like cloth tape not made with natural rubber latex

Easy to use: Tape can be torn lengthwise and crosswise to create a variety of sizes as needed

Adheres to dry skin, tubes, devices and itself

Typical properties

Brands: Durapore™

Factory ISO Certification: No ISO Certification information available

Hypoallergenic: Yes

Material: Silk-like

Product Color: White

Product Type: Medical Tape, Surgical Tape

Units per Pack: 250 , 500

Dimensions and Classifications

Overall Length (Imperial): 1.5 yd, 10 yd

Overall Length (Metric): 1.37 m, 1.372 m, 9.1 m

Overall Width (Imperial): 0.5 in, 1 in, 2 in, 3 in

Overall Width (Metric): 1.27 cm, 2.54 cm, 5 cm, 5.08 cm, 7.62 cm, 25.4 mm, 50.8 mm

3M™ Bair Hugger™ Warming Blanket, 11101, Outpatient

3M ID B00042278

Details

Provides patients with the benefits of prewarming as it works to decrease redistribution temperature drop and enhance patient comfort and warmth

Typical properties

Brands: Bair Hugger™

eClass 14 Classification Group: 34540392

3M™ Bair Hugger™ Warming Blanket 55501, Pediatric Underbody, 10/Case

3M ID 7100212592 UPC 50707387790160

Details

Underbody design warms the patient while providing full, unrestricted patient access

Fluid outlets minimize pooling of fluids on the surface of the blanket

Delivers consistent, even warming by optimized airflow through the blanket's air channel and perf

Typical properties

Application: Medical

Blanket Type: Underbody

Brands: Bair Hugger™

Cladimed Code: Non applicable

Clinical Area: Cardiac & Specialty, OR, Pediatric, Underbody

Drape Length: 24 in

Drape Length (Metric): 61 cm

Drape Width: 24 in

Drape Width (Metric): 61 cm

Factory ISO Certification: No ISO Certification information available

Product Type: Blanket

Quantity: 10 Case

Total Units per Case: 10 per Case

Units per Pack: 10

eClass 14 Classification Group: 34540392

Dimensions and Classifications

Overall Length (Imperial): 36 in

Overall Length (Metric): 91 cm

Overall Width (Imperial): 33 in

Overall Width (Metric): 84 cm

3M™ Bair Hugger™ Warming Blanket 57000, Surgical Access, 10/Case

3M ID 7100212575 UPC 50707387790184

Details

Single-use full-body forced-air warming blanket with 2 convenient resealable hose ports provides excellent heat transfer and flexibility in positioning the warming unit on either side of the patient
Consists of soft, comfortable, lightweight material wit

Typical properties

Application: Medical
Blanket Type: Full Body
Brands: Bair Hugger™
Clinical Area: OR
Drape Length: 24 in
Drape Length (Metric): 61 cm
Drape Width: 16 in
Drape Width (Metric): 41 cm
Factory ISO Certification: No ISO Certification information available
Product Type: Blanket
Quantity: 10 Case
Total Units per Case: 10 per Case
Units per Pack: 10
eClass 14 Classification Group: 34540392

Dimensions and Classifications

Overall Length (Imperial): 84 in
Overall Length (Metric): 213 cm
Overall Width (Imperial): 36 in
Overall Width (Metric): 91 cm

3M™ Blenderm™ Surgical Tape, 1525 Series

Details

Transparent for easy monitoring
Waterproof barrier for protection from external moisture, fluids and contaminants*
Flexible for hard to tape areas
Not made with natural rubber latex and hypoallergenic for sensitive patients

Typical properties

Brands: Blenderm™
Cladimed Code: F51DA1
Condition: Dressing & Device Securement
Department: Cardiovascular, Critical Care, EMERGENCY, I.V. Therapy, Intensive Care Unit, Labor & Delivery, Medical-Surgical, Oncology, Operating Room-Surgery, Orthopedics, Pediatrics, Radiology, Urgent Care, Wound Care
Dressing and Device Securement Condition Type: Occlusive Coverage Needed
Factory ISO Certification: No ISO Certification information available
Hypoallergenic: Yes
Latex: No
Material: Occlusive Plastic
Product Color: Transparent
Product Type: Surgical Tape
Therapeutic Area and Conditions: Transparent Plastic Surgical Tape
Units per Pack: 6 , 12
eClass 14 Classification Group: 34180101

Dimensions and Classifications

Overall Length (Imperial): 5 yd
Overall Length (Metric): 4.5 m
Overall Width (Imperial): 1 in, 2 in
Overall Width (Metric): 2.5 cm, 5 cm

3M™ Steri-Gas™ EO Gas Cartridges, 4-100

3M ID 7100044555 UPC 50707387495522

Details

System offers easy-to-use, cost-effective and efficient sterilant for ethylene oxide sterilization

Precise usage of EO with single-dose cartridge means no sterilant waste

With Steri-Gas cartridges, operators have no bulky, heavy gas tanks to handle, and

Typical properties

Brands: Steri-Gas™

Compatibility: 4XL, 5XL, GS5, GS5X

Factory ISO Certification: No ISO Certification information available

For Use With: 5XL, GS5-1D, GS5-2D

Industries: Life Sciences

Model: 4-100

Product Type: Sterilant

Sterilization Method: Ethylene Oxide (EO)

eClass 14 Classification Group: 34419090

3M™ Attest™ Steam Chemical Integrator with Extender

Details

Easy interpretation within seconds using moving front ink technology with vibrant "ACCEPT" (green) and "REJECT" (red) zones
Features an extender to make it easier to find in the surgical tray
ISO 11140-1:2014 Type 5 Integrating Indicator
For use in all

Typical properties

Brands: Attest™
Catalog Number: 1243RE, 1243RES
Clinical Area: Medical Device Reprocessing Department
Extender Length (Imperial): 2 in, 7 in
Extender Length (Metric): 5.08 cm, 17.8 cm
Factory ISO Certification: No ISO Certification information available
Form: Wick & Extender
Inner Packs per Case: 2 Bags per Case
Product Type: Chemical Indicator
Product Type Free Format: Chemical Integrators
Product Use: Pack Monitoring
Shelf Life: 2 Year, 3 Year
Sterilization Method: Steam
Total Units per Case: 1000 per Case
Units per Inner Pack: 500 per Bag
eClass 14 Classification Group: 34410402

Dimensions and Classifications

Overall Length (Imperial): 4 in, 9 in
Overall Length (Metric): 10.16 cm, 22.9 cm
Overall Width (Imperial): 0.75 in
Overall Width (Metric): 1.9 cm

FUTURO™ Sport Moisture Control Ankle Support 48635EN, Adjustable

3M ID 70005273746 UPC 00051131200579

Details

Moderate-support design offers customizable levels of compression and support
Adjustable straps provide lift and support around your arch
Helps support stiff, sore, or injured ankles
Breathable, moisture-wicking construction allows air to circulate and

Typical properties

Body Part: Ankle

Brands: FUTURO™

Condition: Arthritis, Sprains, Strains

Factory ISO Certification: No ISO Certification information available

Fit Range: 7" to 10.5"

Product Color: Black

Product Type: Wrap around

Product Use: General Support for Athletic Activity

Size: Adjustable

Sizes Available: One Size - Adjustable

Support Level: Moderate

Support Level Description: Provides adjustable levels of compression, support and therapeutic heat retention to help relieve symptoms associated with strains, sprains, arthritis and muscle pain. Comfortable for all day wear or for specific activities.

Support and Compression Level: Moderate

Type: Support

Where to Measure: Measure around ankle.

eClass 14 Classification Group: 34200201

FUTURO™ Sport Adjustable Wrist Support, 09033EN, ADJ

3M ID 70005273654 UPC 00051131201415

Details

Moderate support offers customizable levels of compression and support
Adjustable design provides a customizable fit
Allows your fingers to move naturally
Wear on either wrist for versatility
Supported by our expert panel of engineers and medical prof

Typical properties

Body Part: Wrist
Brands: FUTURO™
Condition: Arthritis, Sprains, Strains, Swelling
Factory ISO Certification: No ISO Certification information available
Fit Range: 4.5" to 9.5"
Product Color: Black
Product Type: Wrap around
Product Use: General Support for Athletic Activity
Size: Adjustable
Sizes Available: One Size - Adjustable
Support Level: Moderate
Support and Compression Level: Moderate
Type: Wrap around
Where to Measure: Measure around wrist.
eClass 14 Classification Group: 34200201

FUTURO™ Performance Knee Support

3M ID CBGBLW011056 UPC 00051131201385

Details

Unique blend of materials offers moderate support
Two-strap, precision closure for customizable support
Flexible materials promote a full range of motion
Wear on either knee for versatility
Ideal for stiff, weak, injured and arthritic knees
Supported

Typical properties

Body Part: Knee
Brands: FUTURO™
Condition: Arthritis, Jumper's Knee, Patella Tracking, Pinched Nerve, Runner's Knee, Sprains, Strains, Swelling, Tendonitis
Factory ISO Certification: No ISO Certification information available
Fit Range: SMALL fits: 13" to 15"
MEDIUM fits: 15" to 17"
LARGE fits: 17" to 19"
X-LARGE fits: 19" to 22"
Material: Neoprene, Nylon, Polyester, Spandex
Product Color: Black
Product Type: Sleeve, Support
Product Use: During Strong Activity, General Support for Athletic Activity, Medial/Lateral Support, Moderate/Occasional Pain, Prevention, Recovery, Weak, Sore Muscles & Injured Knees
Size: Large, Medium, Small, X-Large
Sizes Available: Extra Large, Medium, Large
Support Level: Moderate
Support Level Description: Provides adjustable levels of compression, support and therapeutic heat retention to help relieve symptoms associated with strains, sprains, arthritis and muscle pain. Comfortable for all day wear or for specific activities.
Support and Compression Level: Moderate
Type: Support, Support with Straps
Where to Measure: Measure around kneecap while standing.
eClass 14 Classification Group: 34200201

3M™ Buf-Puf™ Body Sponge, 908-06, 1 ct.

3M ID 70071371523 UPC 00051131908017

Details

Use every day with your favorite soap or cleanser
Thoroughly cleanses skin of dirt and excess oil
Smooths away rough, dry skin
Leaves skin smooth and soft, perfectly prepped for shaving and sunless tanning

Typical properties

Brands: 3M™
Factory ISO Certification: No ISO Certification information available
Package Contents: 1/pack
Product Color: Blue
eClass 14 Classification Group: 29110000

Nexcare™ Athletic Cloth Tape 870-B , 1.5 in x 12.5 yds

3M ID 70007020673 UPC 00051131620988

Details

The professional sports tape that helps prevent injuries and sprains
Provides firm support and protection for weak and injured joints
Strong adhesive stays on, even when wet or as you sweat
Flexible tape moves with you
General purpose sports tape
Ide

Typical properties

Application: Sports
Body Part: Multi-Purpose
Brands: Nexcare™
Condition: Aches/Sprains/Strains
Factory ISO Certification: No ISO Certification information available
Material: Cloth
Package Contents: 1 Pack
Product Color: White
Solution for: Sports
eClass 14 Classification Group: 34180201

Dimensions and Classifications

Overall Length (Imperial): 12.5 yd
Overall Width (Imperial): 1.5 in
Overall Width (Metric): 38 mm

Nexcare™ Flexible Clear First Aid Tape

3M ID COBBLW014019 UPC 00051131913820

Details

From the #1 leader in U.S. hospital tapes
Transparent look for discreet bandaging
Comfortably secures gauze and dressings
Water-resistant formula can be worn in the shower
Stretchy material conforms and flexes with your body
Breathable design provide

Typical properties

Brands: Nexcare™
Factory ISO Certification: No ISO Certification information available
Material: Clear
Product Color: Transparent
Product Type: Tape
Securement Class: Flexible

Dimensions and Classifications

Overall Length (Imperial): 7 yd, 10 yd, 360 in
Overall Length (Metric): 9.1 m, 9.14 m
Overall Width (Imperial): 0.75 in, 1 in
Overall Width (Metric): 19.05 mm, 25.4 mm

Nexcare™ Cold Pack 2646PEG

3M ID 70005264067 UPC 00051131184138

Details

Conveniently store in your freezer for soothing relief
Helps reduce swelling associated with sprains, strains, bumps, bruises, insect bites and more
Flexible design is ideal for use on multiple body parts
Provides cooling comfort on hot days
Great for

Typical properties

Application: Reusable, Sports
Body Part: Multi-Purpose
Brands: Nexcare™
Condition: Aches/Sprains/Strains, Bruises/Muscle Aches/Swelling, Headache
Factory ISO Certification: No ISO Certification information available
Package Contents: 1 Pack
Product Color: Blue
Product Type: Cold
Reusable: Yes
Sizes Available: 1 Pack (Cat# 2646PEG): 4" x 10"
Solution for: Reusable, Sports
Therapy Type: Cold/Hot
Wound Type: Bumps / Bruises, Minor Burns, Scrapes / Cuts / Insect Bites
eClass 14 Classification Group: 34400201

Dimensions and Classifications

Overall Length (Imperial): 10 in
Overall Width (Imperial): 4 in

ACE™ Brand Compression Ankle Support

3M ID COBBLW014053 UPC 00051131203884

Details

Unique combination of elastic and neoprene blend materials provide the desired level of comfort and support
Design offers light compression and stability
Provides support to common injuries such as sprains and strains
Breathable materials allow air to

Typical properties

Body Part: Ankle
Brands: ACE™
Condition: Sprains, Strains
Factory ISO Certification: No ISO Certification information available
Fit Range: S/M fits 6.5" to 9"
L/XL fits 9.5" to 12.5"
Latex-free: No
Material: Natural Rubber Latex, Neoprene, Nylon, Polyester
Product Color: Black
Product Type: Support
Product Use: Recovery
Properties: Breathable
Size: Large/X-Large, Small/Medium
Sizes Available: Large/X-Large, Small/Medium
Support Level: Mild
Support Level Description: Provides light compression, support and therapeutic heat retention to help relieve symptoms associated with minor sprains, strains and arthritis.
Type: Support
Where to Measure: Measure around ankle.
eClass 14 Classification Group: 34200201

ACE™ Brand Adjustable Knee Support

3M ID COBBLW014116 UPC 00051131199231

Details

New! Larger perforations for ultimate breathability
Provides compression and support to stiff, weak, or injured knees and sore muscles
Adjustable straps for customizable support and fit
Soft, neoprene-blend material is breathable to help keep you cool

Typical properties

Body Part: Knee
Brands: ACE™
Condition: Arthritis, Sprains, Strains
Factory ISO Certification: No ISO Certification information available
Fit Range: 11" to 22"
Ideal For: Baseball, Basketball, Cross training, Golf, Hockey, Soccer, Tennis, Volleyball
Latex-free: Yes
Material: Neoprene, Nylon, Polyester, Spandex
Package Contents: 1/pack
Performance Zone Category: Return to Activity
Product Color: Black
Product Type: Support
Product Use: General Soreness, Sprains & Strains, Support for Arthritic Joints
Properties: Adjustable, Breathable, Non Latex Containing, Odor Control
Size: Adjustable
Sizes Available: One Size - Adjustable
Support Level: Moderate
Type: Support
Where to Measure: Measure 3" above kneecap.
eClass 14 Classification Group: 34200201

ACE™ Brand Plantar Fasciitis Sleep Support

3M ID COBBLW014167 UPC 00051131198241

Details

Helps relieve plantar fasciitis symptoms
Foot strap for custom secure fit around your foot
Strong hook tab fasteners to hold securely while wearing
Breathable, moisture-releasing straps are adjustable, durable and soft
Soft edges feel smooth against you

Typical properties

Body Part: Foot
Brands: ACE™
Condition: Sprains, Strains
Factory ISO Certification: No ISO Certification information available
Fit Range: 8" to 15"
Material: Nylon, Polyester, Polypropylene, Polyurethane, Spandex,
Thermoplastic Elastomer (TPE)
Product Color: Navy
Product Type: Support
Properties: Adjustable
Size: Adjustable
Sizes Available: One Size - Adjustable
Support Level: Firm
Where to Measure: Measure around ankle 2" above ankle bone.
eClass 14 Classification Group: 34200201

ACE™ Arm Sling 207395, One Size Adjustable

3M ID 70011004010 UPC 00051131198104

Details

Adjustable, padded shoulder strap
Thumb loop helps hold hand in position
Customizable, cushioned design provides personalized comfort
Quick-release buckle for easy removal
Convenient design can be worn on either arm
One size fits most
ACE is America

Typical properties

Body Part: Arm
Brands: ACE™
Condition: Sprains, Strains
Factory ISO Certification: No ISO Certification information available
Latex-free: Yes
Package Contents: 1/pack
Performance Zone Category: Return to Activity
Product Color: Gray
Product Type: Support
Product Use: General Soreness, Sprains & Strains
Properties: Adjustable, Non Latex Containing, Reusable, Washable
Size: Adjustable
Sizes Available: One Size - Adjustable
Support Level: Mild
Support Level Description: Provides light compression, support and therapeutic heat retention to help relieve symptoms associated with minor sprains, strains and arthritis.
Type: Support
eClass 14 Classification Group: 34200201

ACE™ Brand Hot & Cold Multi-Purpose Wrap

3M ID COBBLW014207 UPC 00051131204034

Details

Insulating design retains hot or cold temperatures for relief
Neoprene-blend wrap holds the gel pack in place for hassle-free relief
Wrap design conforms to multiple body parts
Reuse again and again
Heat therapy is great for muscle aches, cramps, and

Typical properties

Body Part: Multi-Purpose
Brands: ACE™
Factory ISO Certification: No ISO Certification information available
Injury: Arthritis, Bumps/Bruises, Insect Bites, Muscle Aches/Cramps, Sprains & Strains, Swelling
Latex-free: Yes
Performance Zone Category: Injury Care
Product Color: Blue
Product Type: Hot/Cold Therapy
Properties: Adjustable, Comfort Touch, Non Latex Containing, Reusable
Size: Adjustable
Sizes Available: One Size Fits Most, Adjustable
Type: Hot/Cold Therapy
eClass 14 Classification Group: 34400201

FUTURO™ Dual Strap Knee Support, 09195ENR, Adjustable

3M ID 70007013397 UPC 00051131212718

Details

Applies moderate pressure on your injured tendons to help relieve symptoms of patella tendonitis
Soothing gel pads deliver targeted pressure
Adjustable straps for custom comfort
Breathable material releases excess heat for cooling comfort
Low-profile

Typical properties

Body Part: Knee
Brands: FUTURO™
Condition: Arthritis, Jumper's Knee, Patella Tracking, Pinched Nerve, Runner's Knee, Sprains, Strains, Swelling, Tendonitis
Factory ISO Certification: No ISO Certification information available
Fit Range: 12.5" to 17.5"
Material: Neoprene, Nylon, Polyester, Polyurethane, Spandex, Thermoplastic Elastomer (TPE)
Product Color: Black
Product Type: Strap
Product Use: During Strong Activity, General Support for Athletic Activity, Jumpers Knee, Medial/Lateral Support, Moderate/Occasional Pain, Prevention, Recovery, Weak, Sore Muscles & Injured Knees
Size: Adjustable
Sizes Available: One Size - Adjustable
Support Level: Moderate
Support and Compression Level: Moderate
Type: Wrap around
Where to Measure: Measure around leg below kneecap.
eClass 14 Classification Group: 34200201

Nexcare™ Cushioned Waterproof Bandages

3M ID CBGBLRUS1500 UPC 00051131997172

Details

Advanced water-resistant adhesive sticks to damp or sweaty skin
Waterproof design stays on skin in the bath, shower or pool
Cushioned material helps protect cuts, scrapes and blisters
The unique shape is designed to seal around the pad
Leaves minimal

Typical properties

Application: Waterproof
Brands: Nexcare™
Factory ISO Certification: No ISO Certification information available
Package Contents: 8 Pack,20 pack
Product Color: Tan
Product Type: Bandage
Properties: Waterproof
Size: Assorted
Sizes Available: 20 ct. Asst: 6 at 1.15" x 3" (29mm x 76mm), 8 at .9" x 2.25" (22mm x 57mm), 6 at .96" x 1.15" (24mm x 29mm); Knee & Elbow: 2" x 4" (50mm x 101mm)
Solution for: Cushioning, Knees/Elbows, Sports, Waterproof
Waterproof: Yes
Wound Type: Blisters
eClass 14 Classification Group: 34400201

Dimensions and Classifications

Overall Length (Metric): 101 mm
Overall Width (Metric): 50 mm

3M™ Multipore™ Dry Surgical Tape, 373X Series

Details

Strong adhesion: good initial adhesion to dry and wet skin
Strong backing: specialized backing repels water and resists tearing under stress
Easy to use: Removable grid liner for precise cutting and customization to any shape and size with scissors
Con

Typical properties

Brands: Multipore™
Factory ISO Certification: No ISO Certification information available
Hypoallergenic: Yes
Material: Pique
Product Type: Surgical Tape

Dimensions and Classifications

Overall Length (Imperial): 5.5 yd
Overall Length (Metric): 5 m
Overall Width (Imperial): 0.5 in, 1 in, 2 in
Overall Width (Metric): 1.25 cm, 2.5 cm, 5 cm

3M™ Steri-Drape™ Stockinette, Small, 25 per Carton / 4 Cartons per Case, 9109

3M ID 7000053846 UPC 00707387579548

Details

Superior Strength and Comfort
Impervious to Strikethrough
Fluid Control Features

Typical properties

Brands: Steri-Drape™
Cladimed Code: E51DA03
Factory ISO Certification: No ISO Certification information available
Product Type: Hand/Foot Drape
Units per Pack: 25

Dimensions and Classifications

Overall Length (Imperial): 29.921 in
Overall Length (Metric): 76 cm
Overall Width (Imperial): 8.661 in
Overall Width (Metric): 22 cm

**3M™ Bair Hugger™ 500 and 700 Series Power Cord, Model 90224,
120V, North America/Japan, 1 EA**

3M ID 7100087678 UPC 00707387775780

Details

Length: 15 feet

Typical properties

Brands: Bair Hugger™

Factory ISO Certification: No ISO Certification information available

Product Type: Accessory

Quantity: 1 each

3M™ Tegaderm™ High Integrity Alginate Dressing

Details

Gel forming for optimal moist wound healing environment
Supports healing – Maintains optimal moisture levels needed for healing tissue
Highly conformable primary wound dressing
Compatible with 3M cover dressings

Typical properties

Brands: Tegaderm™
Factory ISO Certification: No ISO Certification information available
eClass 14 Classification Group: 34210402

Dimensions and Classifications

Overall Length (Imperial): 4 in, 12 in
Overall Length (Metric): 10.16 cm, 30.48 cm
Overall Width (Imperial): 0.787 in, 4 in
Overall Width (Metric): 2 cm, 10.16 cm

3M™ CoTran™ Nonwoven Polyester Tape, 9698, Config Roll

3M ID 7100065992

Details

Tan
Breathable
Highly conformable
High tack pressure sensitive acrylate adhesive

Typical properties

Brands: CoTran™
Factory ISO Certification: No ISO Certification information available
Liner Caliper (Metric): 114 µm
Liner Caliper (mils): 4.5 mil
Product Color: Tan
Tape Total Caliper: 15.5 mil
Tape Total Caliper (Metric): 394.0 µm
eClass 14 Classification Group: 34180201

Dimensions and Classifications

Overall Length (Imperial): 250 yd
Overall Length (Metric): 228 m
Overall Width (Imperial): 50 in
Overall Width (Metric): 127 cm

3M™ Medical Tape 1523, Single Sided Blush Tan Polyethylene, 63# Liner, Configurable

3M ID 7100085732

Details

Tackified Acrylic Adhesive
Fluid Resistant
Good Processability

Typical properties

Adhesive Material: Acrylate
Adhesive Type: Acrylic/Acrylate (Tack)
Backing Caliper: 3.6 mil
Backing Caliper (Metric): 90 Micron
Backing Material: Polyethylene
Backing Thickness (Imperial): 3.6 mil
Backing Thickness (Metric): 90 Micron
Brands: 3M™
Breathable: No
Conformability: Medium
Factory ISO Certification: No ISO Certification information available
Fluid Resistance Backing/Carrier: Yes
Hypoallergenic: No
Latex: No
Liner Caliper (Metric): 120 Micron
Liner Caliper (mils): 4.9 mil
Liner Color: White
Liner Material: Paper
Liner Weight: 63.0 lb.
Liner Weight (Metric): 103 g/m²
Material: Polyethylene
Maximum Length (Metric): 457 m
Maximum Width Capacity: 48 in
Maximum Width Capacity (Metric): 1220 mm
Printable Backing: Yes
Product Color: Blush
Product Type: Polyethylene
Product Usage: Adhesion to Skin, Adhesion to Substrate
Sterilization Method: Ethylene Oxide (EO), Gamma
Tape Total Caliper: 5.0 mil
Tape Total Caliper (Metric): 130.0 Micron
Tape Type: Single-sided Polyethylene Tape
eClass 14 Classification Group: 34180101

Dimensions and Classifications

Overall Thickness (Imperial): 1 in
Overall Thickness (Metric): 0.13 mm

Overall Width (Imperial): 48 in
Overall Width (Metric): 121.92 cm

3M™ Cavilon™ Advanced Skin Protectant

Details

Provides an effective barrier, which has been shown to reduce the pain of managing incontinence-associated dermatitis (IAD)* and helps to prevent skin damage from body fluids *3M™ Cavilon™ Advanced Skin Protectant is not an analgesic

Lasts up to 7 days a

Typical properties

Anti-fungal: No

Brands: Cavilon™

Condition: Wound Care

Delivery System: Applicator

Department: Critical Care, Wound Care

Factory ISO Certification: No ISO Certification information available

Hypoallergenic: Yes

Latex: No

Moisturizing: No

Product Type: Barrier Film

Volume (Metric): 2.7 mL

Wound Care Condition Type: Venous Leg Ulcer

3M™ Scotchpak™ Polyester Packaging Film Laminate, MA250M, Config Roll

3M ID 7100119887

Details

Translucent
Occlusive
Printable
Not corona treated
Matte finish on one side
Heat Sealable (EAA)

Typical properties

Backing (Carrier) Material: Polyester
Brands: Scotchpak™
Caliper: 2.45 mils
Caliper (Metric): 62.23 µm
Catalog Number: MA250M
Elongation CD: 59%
Elongation MD: 70%
Factory ISO Certification: No ISO Certification information available
Heat Seal: 14 lb/in
Heat Seal (Metric): 62.27 N/25.4 mm
Heat Seal Layer: Ethylene Acrylic Acid (EAA)
MVTR (g/m²/24 hr): N/T
Oxygen Transmission (cc/m²/24hr): N/T
Product Color: Translucent
Sample Roll: 6 in x 25 yds
Sample Roll (Metric): 15 cm x 23 m
eClass 14 Classification Group: 41011103

Dimensions and Classifications

Overall Length (Imperial): 1500 yd
Overall Length (Metric): 1372 m
Overall Width (Imperial): 40 in
Overall Width (Metric): 1020 cm

3M™ Attest™ Steam Chemical Integrator Test Pack, 41360, Type 5, 16/CAR, 4 CAR/CS, 64/CS

3M ID 7100208315 UPC 50707387787245

Details

Immediate results without the need for color interpretation using moving front ink technology with vibrant "ACCEPT" (green) and "REJECT" (red) zones
Includes a 3M™ Attest™ Steam Chemical Integrator 1243R, Type 5, record-keeping sheet and process indicato

Typical properties

Brands: Attest™
Catalog Number: 41360
Clinical Area: Medical Device Reprocessing Department
Factory ISO Certification: No ISO Certification information available
Form: Wick
Inner Packs per Case: 4 Cartons per Case
Product Type: Test Pack
Product Use: Load Monitoring
Sterilization Method: Steam
Total Units per Case: 64 per Case
Units per Inner Pack: 16 per Carton
eClass 14 Classification Group: 34410402

3M™ Bair Hugger™ 500 and 700 Series Sheet Clip, Model 90063, 1 EA

3M ID 7100087661 UPC 00707387775797

Details

May be used with Bair Hugger 500 and 700 series warming units

Typical properties

Brands: Bair Hugger™

Cladimed Code: F59AB99

Clinical Area: OR, PACU, Pre-op

Factory ISO Certification: No ISO Certification information available

Model: 90063

Product Type: Accessory

Quantity: 1 each

Units per Pack: 1

Dimensions and Classifications

Overall Length (Imperial): 0.5 in

3M™ Dermatac™ Drape with V.A.C.® Granufoam™ Dressing Kit

Details

The first-ever hybrid drape that combines the benefits of both silicone and acrylic for use with 3M™ V.A.C.® Therapy

Detaches without difficulty when stuck to gloves or itself and can be repositioned at initial application

Reduces time associated with

Typical properties

Brands: Dermatac™

Factory ISO Certification: No ISO Certification information available

Size: Large, Medium, Small

eClass 14 Classification Group: 34210701

3M™ Prevena Restor™ ArthroForm™ Dressing

Details

Available in two dressing options with for use to manage incisions and the surrounding soft tissue (33x30 cm & 46x30cm) for up to 7 days
Provide expanded coverage area and delivers therapy to the incision and surrounding soft tissue envelope while bolste

Typical properties

Brands: Prevena Restor™

Factory ISO Certification: No ISO Certification information available

Dimensions and Classifications

Overall Length (Metric): 31.3 cm

Overall Width (Metric): 33 cm, 45.7 cm

V.A.C. VERAFL0™ Dressing, ULTVFL05SM, Small, 5/pk

3M ID 7100238749 UPC 00849554001299

Details

Comes in 3 convenient sizes to treat small, medium and large wounds
Small and Medium Dressings feature spiral cut foam for easy application: -Size without scissors -Precut area for pad application when used for bridging
Large Dressing features two layer

Typical properties

Brands: Veraflo™

Catalog Number:

ULTVFL05LGV002.S,ULTVFL05MDV001.S,ULTVFL05LGV001.S,ULTVFL05SMV001.S,ULTVFL05SMV002.S,ULTVFL05SM.S,ULTVFL05MDV002.S

Factory ISO Certification: No ISO Certification information available

Size: Large, Medium, Small

Total Units per Case: 5 per Case

eClass 14 Classification Group: 34210701

Dimensions and Classifications

Overall Length (Metric): 11 cm

Overall Thickness (Imperial): 0.709 in

Overall Thickness (Metric): 1.8 cm

Overall Width (Metric): 8 cm

3M™ V.A.C. VeraT.R.A.C. Duo™ Tube Set

3M ID B5005265170

Details

Supplied with all 3M™ V.A.C. Veraflo™ Large Dressing Kits
Can be ordered separately as an accessory in a case of 5

Typical properties

Brands: VeraT.R.A.C. Duo™

Factory ISO Certification: No ISO Certification information available

eClass 14 Classification Group: 34210701

ACTIV.A.C.™ Therapy Unit, 340000, 1/ea

3M ID 7100237901 UPC 00878237008188

Details

3M™ ActiV.A.C.™ Therapy System is ideal for patients transitioning to home care
Creates an environment that promotes wound healing by promoting granulation tissue formation
Ergonomic design is lightweight, small, and easy to use

Typical properties

Brands: ActiV.A.C.™
Factory ISO Certification: No ISO Certification information available
eClass 14 Classification Group: 34210701

3M™ V.A.C.® Ulta Therapy Unit

3M ID B5005265197

Details

One device, four therapies: 3M™ V.A.C.® Therapy, 3M™ Veraflo™ Therapy, 3M™ AbThera™ Therapy, and 3M™ Prevena™ Therapy
Efficient: Standardized software helps to simplify training
The Smart Instill™ Feature automates and simplifies Veraflo therapy

Typical properties

Brands: V.A.C.®

Factory ISO Certification: No ISO Certification information available
eClass 14 Classification Group: 34210701

3M™ Medical Silicone Tape, 2484, Hi-Tack Single Sided Polyurethane, Configurable

3M Product Number 2484 3M ID 7100290699

Details

Breathable
Repositionable
Conformable
Doesn't strip skin cells

Typical properties

Adhesive Type: Silicone
Backing Caliper: 0.9 mil
Backing Caliper (Metric): 22.9 Micron
Brands: 3M™
Breathable: Yes
Conformability: High
Factory ISO Certification: No ISO Certification information available
Product Usage: Adhesion to Skin
eClass 14 Classification Group: 34180101

**3M™ Medical Tape 1509EL, Double Sided Transparent Polyethylene,
80#
Liner, CONFIGURABLE**

3M ID 7100127435

Details

Tackified Acrylic Adhesive
Fluid Resistant
Good Processability

Typical properties

Brands: 3M™
Factory ISO Certification: No ISO Certification information available
Hypoallergenic: No
eClass 14 Classification Group: 34180101

Dimensions and Classifications

Overall Width (Imperial): 48 in
Overall Width (Metric): 121.92 cm

3M™ Bair Hugger™ Temperature Monitoring Control Unit, 37000, 120V-ENG-A, 1 Each

Part Number 120V-ENG-A 3M ID 7100236002 UPC 00707387792961

Details

Non-invasive technique: A single-use sensor is placed on the patient's forehead before surgery and is worn throughout the perioperative journey. Non-invasive method eliminates the potential of trauma from invasive modalities

Accurate: In a clinical trial

Typical properties

Brands: Bair Hugger™

Clinical Area: OR, PACU, Pre-op

Contents: Control unit, sensor cable, monitor cable, power supply, operator's manual, and an installation and service manual

Factory ISO Certification: No ISO Certification information available

Leakage Current: Meets leakage current requirements in accordance with UL 60601-1 and EN 60601-1.

Model: 37000

Product Type: System

Quantity: 1 each

Total Units per Case: 1 per Case

eClass 14 Classification Group: 34540391

Dimensions and Classifications

Overall Height (Imperial): 3.7 in

Overall Height (Metric): 9.3 cm

Overall Length (Imperial): 3.7 in

FUTURO™ Comfort Fit Wrist Support, Adjustable

3M ID 70007070496 UPC 00051131224636

Details

Moderate support and adjustable compression for weak, sore or injured wrists
Designed for all-day and everyday comfort and support
Easy to apply wrap-around design
Ultra breathable and moisture wicking, neoprene blend material to keep you cool and dry

Typical properties

Body Part: Wrist
Brands: FUTURO™
Condition: Arthritis, Carpal Tunnel Syndrome, Pinched Nerve, Repetitive Stress Injury, Sprains, Strains, Swelling, Tendonitis, Thumb Hyperextension
Factory ISO Certification: No ISO Certification information available
Material: Neoprene, Nylon, Polyester, Spandex
Product Color: Gray
Product Type: Support
Size: Adjustable
Support and Compression Level: Moderate
eClass 14 Classification Group: 34200201

3M™ Attest™ Steam Chemical Integrator

Details

Moving front ink technology with vibrant "Accept" (Green) and "Reject" (Red) zones for easy interpretation within seconds
3M™ Attest™ Steam Chemical Integrators are used for pack control monitoring compliant with ISO 11140-1: 2014. Please review the inst

Typical properties

Brands: Attest™
Catalog Number: 1243B,1243A
Clinical Area: Medical Device Reprocessing Department
Factory ISO Certification: No ISO Certification information available
Form: Wick
Inner Packs per Case: 2 Bags per Case, 10 Bags per Case
Product Type: Chemical Indicator
Product Type Free Format: Chemical Integrators,Chemical Indicator
Product Use: Pack Monitoring
Shelf Life: 2 Year
Sterilization Method: Steam
Total Units per Case: 1000 per Case
Units per Inner Pack: 100 per Bag, 500 per Bag
eClass 14 Classification Group: 34410402

Dimensions and Classifications

Overall Length (Imperial): 2 in
Overall Length (Metric): 5.1 cm
Overall Width (Imperial): 0.75 in
Overall Width (Metric): 1.9 cm

3M™ PICC / CVC Securement Device + Tegaderm™ I.V. Advanced Securement Dressing

Details

Convenient single package containing a catheter stabilization device with a silicone adhesive and an IV securement dressing
Sutureless securement balances reliable adhesion with gentleness to skin
PICC/CVC system requires a higher pull force than suture

Typical properties

Brands: Tegaderm™
Catalog Number: 1839-2100,1837-2100
Cladimed Code: F51CA99
Condition: I.V. Related
Department: Cardiovascular, EMERGENCY, Home Care, Home Infusion, Long-Term Acute Care, Long-Term Care, Medical-Surgical, Oncology, Operating Room-Surgery, Out Patient Infusion, Pediatrics, Radiology, Urgent Care
Dressing Type: Transparent Semipermeable Membrane (TSM)
Factory ISO Certification: No ISO Certification information available
Hypoallergenic: Yes
IV Related Condition Type: CVC Short-Term, PICC
Latex: No
Product Color: Transparent
Product Type: Securement Dressing
Product Use: CVC, PICC
eClass 14 Classification Group: 34180202

Dimensions and Classifications

Overall Length (Imperial): 4.5 in, 6.125 in
Overall Length (Metric): 11.5 cm, 15.5 cm
Overall Width (Imperial): 3.5 in, 4 in
Overall Width (Metric): 8.5 cm, 10 cm

3M™ Bair Hugger™ Warming Blanket, 63000, Sterile Cardiac, 5/Case

3M ID 7100236258 UPC 50707387804140

Details

Single-use lower body forced-air warming blanket provides excellent heat transfer during cardiothoracic and vascular procedures

Consists of soft, radiolucent materials

Warms the lower body to help reduce core-to-peripheral heat loss

Positions easily in

Typical properties

Application: Medical

Blanket Type: Full Body

Brands: Bair Hugger™

Cladimed Code: Non applicable

Clinical Area: OR

Factory ISO Certification: No ISO Certification information available

Product Type: Blanket

Quantity: 5 Case

Total Units per Case: 5 per Case

Units per Pack: 25

eClass 14 Classification Group: 34540392

Dimensions and Classifications

Overall Length (Imperial): 60 in

Overall Length (Metric): 91 cm

Overall Width (Imperial): 36 in

Overall Width (Metric): 152 cm

3M™ Promogran™ Collagen Matrix with ORC

Details

Unlike any other collagen dressing
The 3M™ Promogran™ Matrix Family of collagen dressings are the most studied collagen dressings in the world
The Promogran Matrix Family are the only collagen dressings uniquely formulated with Oxidized Regenerated Cell

Typical properties

Boxes per Case: 4.0
Brands: Promogran™
Catalog Number: PG004,PG019
Factory ISO Certification: No ISO Certification information available
HCPCS Code: A6021, A6022
Inner Packs per Case: 4 Cartons per Case
Product Form: Hexagon
Surface Area (Imperial): 4.34 in², 19.1 in²
Surface Area (Metric): 28 cm², 123 cm²
Total Units per Case: 40 per Case
Units per Inner Pack: 10 per Carton

3M™ Adaptic™ Non-Adhering Dressing

Details

Enables fluid transfer to a secondary dressing, reducing the risk of exudate pooling and maceration¹

Can be used under compression²

Cutable

Typical properties

Brands: Adaptic™

Factory ISO Certification: No ISO Certification information available

eClass 14 Classification Group: 34210402

Dimensions and Classifications

Overall Length (Imperial): 3 in, 5 in, 8 in, 9 in, 60 in

Overall Length (Metric): 7.6 cm, 12.7 cm, 20.3 cm, 22.9 cm, 152.4 cm

Overall Width (Imperial): 3 in, 5 in, 8 in, 9 in, 16 in, 60 in

Overall Width (Metric): 7.6 cm, 12.7 cm, 20.3 cm, 22.9 cm, 40.6

SNAP™ SecurRing™ Hydrocollloid, SRNG10, 2 in, 10/pk

3M ID 7100238684 UPC 00849554006362

Details

Reduces accessories needed to seal and protect the wound from moisture
Increased adhesion of the 3M™ Snap™ Dressing on dry and uneven skin

Typical properties

Brands: Snap™

Factory ISO Certification: No ISO Certification information available

eClass 14 Classification Group: 34210701

Dimensions and Classifications

Overall Diameter (Imperial): 2 in

3M™ V.A.C.® Tubing Cap

3M ID B5005265167

Details

Tubing cap compatible with all 3M™ V.A.C.® Therapy Units
Available in a case of 5
Available in a case of 10

Typical properties

Brands: V.A.C.®
Factory ISO Certification: No ISO Certification information available
eClass 14 Classification Group: 34210701

3M™ Comply™ Bowie-Dick Test Pack, 1233LF, 6 Pack/Bag, 5 Bag/Case

3M ID 7000002931 UPC 50707387584158

Details

Easy-to-read test sheet clearly identifies failures and can be filed for record keeping

Lead Free Ink Chemistry

Equivalent to the Bowie-Dick Towel Pack cited in AAMI

Ink is not made with lead materials

3M™ Comply™ Bowie-Dick Plus Test Pack 1233LF is e

Typical properties

Brands: Comply™

Factory ISO Certification: No ISO Certification information available

Model: 1233LF

Product Type: Bowie-Dick

Product Use: Equipment Monitoring

Sterilization Method: Steam

Units per Case: 30.0

eClass 14 Classification Group: 34410501

Dimensions and Classifications

Overall Height (Imperial): 5.118 in

Overall Height (Metric): 13 cm

Overall Length (Imperial): 4.331 in

Overall Length (Metric): 11 cm

Overall Width (Imperial): 0.787 in

Overall Width (Metric): 2 cm

3M™ Microfluidic Diagnostic Hydrophilic Film, 9938

3M ID B5005325043

Details

Hydrophilic treatment on one side with protective back-side treatment

Transparent

Non-toxic to mammalian cells and non-hemolytic

Dimensionally stable

Typical properties

Brands: 3M™

eClass 14 Classification Group: 34180101

3M™ Tube Securement Device

Details

Reliable securement: Adhesive delivers strong securement, adhering medical tubes such as urinary catheters and surgical drain tubes to skin for up to 4 days¹
Skin performance: Designed to help reduce the risk of pressure injury with no hard plastic compo

Typical properties

Boxes per Case: 4.0
Brands: 3M™
Catalog Number: 1500U, 1501U
Factory ISO Certification: No ISO Certification information available
Size: Large, Small
Units per Case: 100.0
Units per Pack: 25
eClass 14 Classification Group: 34180202

Dimensions and Classifications

Overall Length (Imperial): 1.7 in, 2.2 in
Overall Length (Metric): 4.3 cm, 5.5 cm
Overall Width (Imperial): 2.4 in, 3.5 in
Overall Width (Metric): 6.1 cm, 9 cm

3M™ Tegaderm™ Silicone Foam Dressing

Details

Strong and gentle silicone adhesive keeps the dressing in place with minimal disruption to the skin during removal

Unique multi-layer design absorbs and evaporates moisture while adapting to changing levels of exudate to maintain an optimal wound healing

Typical properties

Adhesive: Yes

Adhesive Type: Silicone

Backing Material: Foam

Border: No

Boxes per Case: 4.0

Brands: Tegaderm™

Breathable: Yes

Catalog Number: 90631,90632

Condition: Dressing & Device Securement, Pressure Ulcer, Wound Care

Department: Home Care, Long-Term Care, Wound Care

Dressing and Device Securement Condition Type: Wounds

Factory ISO Certification: No ISO Certification information available

Hypoallergenic: No

Inner Packs per Case: 4 Cartons per Case

Latex: No

Product Type: Foam Dressing

Shape: Square

Sterile: Yes

Therapeutic Area and Conditions: Arterial ulcer, Pressure Ulcers, Surgical

Wounds, Venous Leg Ulcer

Total Units per Case: 40 per Case

Units per Case: 40.0

Units per Inner Pack: 10 per Carton

Units per Pack: 10

Wound Care Condition Type: Venous Leg Ulcer

eClass 14 Classification Group: 34210409

Dimensions and Classifications

Overall Length (Imperial): 4 in, 6 in

Overall Length (Metric): 10 cm, 15 cm

Overall Width (Imperial): 4.25 in, 6 in

Overall Width (Metric): 11 cm, 15 cm

3M™ AbThera™ SensaT.R.A.C.™ Open Abdomen Dressing

3M ID B5005265108

Details

Actively removes fluid and helps reduce edema

Provides medial tension which helps minimize fascial retraction and loss of domain

Provides separation between the abdominal wall and viscera, protecting abdominal contents

Protects abdominal contents from

Typical properties

Brands: AbThera™

Factory ISO Certification: No ISO Certification information available

PREVENA PLUS™ 125 Therapy Unit, PRE4000US, 1/ea

3M ID 7100237234

Details

The 3M™ Prevena™ 125 Therapy Unit provides pre-set, continuous NPWT at -125mmHg up to 7 days

The 3M™ Prevena™ Plus 125 Therapy Unit is a disposable, single patient use device with a rechargeable battery (Weight 0.64 lbs/0.29 Kg; Dimensions 16.3 x 8.9 x 5

Typical properties

Brands: Prevena™

Factory ISO Certification: No ISO Certification information available

3M™ Bair Hugger™ Animal Health Underbody Blanket

Details

Single-use underbody forced-air warming blanket warms animal patients while providing full, unrestricted patient access
Unique fluid outlets minimize pooling of fluids on the surface of the blanket
Constructed with soft, radiolucent materials
Resealabl

Typical properties

Application: Veterinary
Blanket Type: Underbody
Brands: Bair Hugger™
Drape Length: 24 in
Drape Length (Metric): 61 cm
Drape Width: 24 in
Drape Width (Metric): 61 cm
Factory ISO Certification: No ISO Certification information available
Product Type: Blanket
Quantity: 1 each
Total Units per Case: 10 per Case
eClass 14 Classification Group: 34540392

Dimensions and Classifications

Overall Length (Imperial): 36 in, 60 in
Overall Length (Metric): 91 cm, 152 cm
Overall Width (Imperial): 32 in, 33 in
Overall Width (Metric): 81 cm, 84 cm

3M™ V.A.C. Veraflo Cleanse Choice™ Dressing

3M ID B5005265132

Details

Reduces the number of surgical debridements required
Three foam layers to provide application options for wounds with varying depths
"Honeycomb" pattern contact layer
Conformable thin cover layer for shallower wounds and thick cover layer for deeper wo

Typical properties

Brands: Veraflo™
Catalog Number: ULTVCC05LG, ULTVCC05MD
Factory ISO Certification: No ISO Certification information available
Size: Large, Medium
Total Units per Case: 5 per Case
eClass 14 Classification Group: 34210701

3M™ Nu-Gel™ Hydrogel with Alginate

3M ID B5005265144

Details

Easy to use ampoule

The alginate component increases the absorptive capacity¹

Longer wear time vs Intrasite Gel¹

Typical properties

Brands: Nu-Gel™

Dressing Type: Hydrogel

Factory ISO Certification: No ISO Certification information available

Net Weight (Imperial): 0.88 oz

Net Weight (Metric): 15 g, 25 g

Volume (Imperial): 0.52 fl oz, 0.88 fl oz

3M™ V.A.C.® Simplicity Therapy Unit

3M ID B5005265195

Details

Simple interface minimizes device training time
Automatically delivers the most commonly prescribed NPWT setting of continuous -125mm Hg
Quick release canisters allow for efficient replacement
Multi-orientational canister allows for patient mobility an

Typical properties

Brands: V.A.C.®
eClass 14 Classification Group: 34210701

3M™ Steri-Strip™ Wound Closure System

3M ID B00036351

Details

Helps improve cosmetic outcomes – Non-invasive, sterile design helps reduce scarring and the risk of infection, compared to sutures and staples, with less tissue trauma and better cosmetic outcomes. (Reference on file)
Protects – Provides both bacterial

Typical properties

Brands: Steri-Strip™
eClass 14 Classification Group: 34180306

3M™ Microfluidic Diagnostic Hydrophilic Film, 9901PB

3M ID B5005455014

Details

Hydrophilic treatment on one side with protective blue premask
Transparent
Non-toxic to mammalian cells and non-hemolytic
Dimensionally stable

Typical properties

Brands: 3M™
Catalog Number: 9901PB
eClass 14 Classification Group: 34180101

ECG Reusable Leadwire

Details

3M is a trusted source for reusable ECG leadwires
Trust 3M for all of your ECG monitoring needs. Our full range of ECG monitoring products including AMC&E Reusable Leadwire solutions offer both value and quality
Individual replacement leadwire
Sold in

Typical properties

Brands: 3M™
Case Packaging: 10 Electrode/Bag, 100 Bags/Case or 1000 Electrodes/Case, 100 Electrode/Bag, 40 Bags/Case or 4000 Electrodes/Case, 3 Electrodes/Package; 100 Packages or 300 Electrodes/Case, 3 Electrodes/Package; 200 Packages or 600 Electrodes/Case, 5 Electrodes/Package; 200 Packages or 1000 Electrodes/Case
Compatibility: AAMI/Philips Twin Pin, Datex-Ohmeda, Draeger VS/VR, Draeger Single Pin, GE, Nihon Kohden, Philips, Safety DIN, Spacelabs
Disposable: No, Yes
Electrode Connection: Mini Pinch, Pinch, Snap
Factory ISO Certification: No ISO Certification information available
Model: AA29102, AA29106, AA29302, AA29306, AA29306-T, AA51102, AA51106, AA5111+5, AA5112+5, AA5113+5, AA5114+5, AA5115+5, AA51302, AA51306, D024105, D24102, D24103, D24106, D2411+10, D2412+10, D2413+10, D2414+10, D2415+10, D24302, D24303, D24306, D29203, D29206, D40102, D40106, D4011+10, D4012+10, D4013+10, D4014+10, D4015+10, D40202, D402X02, D402X06, D40302, D40306, D722X02, D722X06
Number of Leads: 1, 3, 5
Product Type: Leadwire
Radiolucency: Radiolucent, Radiopaque
Yoke Connection: AMII/Phillips Twin Pin, AMII/Phillips Twin Pin with Telemetry Cap, Safety DIN
eClass 14 Classification Group: 34090507

Dimensions and Classifications

Overall Length (Imperial): 24 in, 29 in, 40 in, 48 in, 51 in, 72 in
Overall Length (Metric): 183 cm

**3M™ Littmann® Diaphragm for Littmann® Electronic Model 3200
Stethoscope,
Black**

3M ID 7100008783 UPC 00707387777357

Details

Black

Typical properties

Brands: Littmann®

Cladimed Code: K50BE02

Diaphragm Diameter (Imperial): 2 in

Diaphragm Diameter (Metric): 51 mm

Factory ISO Certification: No ISO Certification information available

Model: Electronic 3200

Product Color: Black

Product Type: Spare Parts Kit

eClass 14 Classification Group: 34340191

3M™ Precise™ Pistol Grip Skin Stapler

3M ID B00038538

Details

3M™ Precise™ PGX Disposable Skin Stapler provides you consistent wound closure with every use. Available in two configurations: 15 wide and 35 wide staples

Handles like a well-balanced, precision surgical instrument

Designed to deliver consistent perfor

Typical properties

eClass 14 Classification Group: 34330701

**3M™ Steri-Drape™ Cardiovascular Pack with Ioban™ 2 Incise Film
6677P,
4/Case**

3M ID 7000030321 UPC 00707387579586

Details

Superior Strength and Comfort
Resistant to Strikethrough
Fluid Control Features

Typical properties

Additional Drapes: Pack
Brands: Steri-Drape™
Cladimed Code: E51BF99
Factory ISO Certification: No ISO Certification information available
Product Type: Cardiovascular Pack
Product Use: Procedure Specific

3M™ Steri-Drape™ Extremity Surgical Pack 9004, 5 per Carton / 2 Cartons per Case

3M ID 7000002685 UPC 50707387455953

Details

2 OP Tapes, 4 Hand Towels, 1 Mayo Stand Cover, 1 Drape Sheet, 1 Adhesive Towel, 1 Extremity Drape, 1 Instrument Table Cover
Resistant to Strikethrough
Fluid Control Features
Fluid Control Features

Typical properties

Additional Drapes: Pack
Brands: Steri-Drape™
Cladimed Code: E51AG04
Factory ISO Certification: No ISO Certification information available
Product Color: Blue
Product Type: Extremity Pack
Product Use: General Surgery
Units per Pack: 5

3M™ Steri-Drape™ Orthopaedic Surgical Pack, 9014, 5/Carton, 2/Case

3M ID 7000030182 UPC 50707387457612

Details

2 9099 Op Tapes, 4 Hand Towels, 1 9035 Mayo Stand Cover, 1 9072 Drape Sheet, 1 9041 Extremity Cover, 1 9053 Extremity Drape, 1 9077 Back Table Cover

Resistant to Strikethrough

Fluid Control Features

Fluid Control Features

Typical properties

Additional Drapes: Pack

Brands: Steri-Drape™

Cladimed Code: E51AG04

Factory ISO Certification: No ISO Certification information available

Product Color: Blue

Product Type: Extremity Pack

Product Use: General

Units per Pack: 5

3M™ Steri-Drape™ Adhesive Drape Sheet 9087NS, 72 IN x 72 IN, 50/CS

3M ID 7000053598 UPC 00707387456719

Details

Resistant to Strikethrough

Reliable, dependable adhesive

Fluid Control Features

Reliable, dependable adhesive (around aperture, etc.) stays secure throughout the procedure

Typical properties

Additional Drapes: Sheet

Brands: Steri-Drape™

Cladimed Code: E51DA01

Factory ISO Certification: No ISO Certification information available

Product Type: Drape Sheet

Product Use: Surgical Sheet

Dimensions and Classifications

Overall Length (Metric): 183 cm

Overall Width (Metric): 183 cm

3M™ Steri-Drape™ Adhesive Drape Sheet 9088NS, 98 IN x 59 IN, 50/CS

3M ID 7000053600 UPC 00707387456733

Details

Resistant to Strikethrough

Reliable, dependable adhesive

Fluid Control Features

Reliable, dependable adhesive (around aperture, etc.) stays secure throughout the procedure

Typical properties

Additional Drapes: Sheet

Brands: Steri-Drape™

Cladimed Code: E51DA01

Factory ISO Certification: No ISO Certification information available

Product Type: Drape Sheet

Product Use: Surgical Sheet

Dimensions and Classifications

Overall Length (Metric): 152 cm

Overall Width (Metric): 250 cm

3M™ Steri-Drape™ Adhesive Drape Sheet 9090NS, 118 IN x 89 IN, 20/CS

3M ID 7000053602 UPC 00707387456757

Details

Resistant to Strikethrough

Reliable, dependable adhesive

Fluid Control Features

Reliable, dependable adhesive (around aperture, etc.) stays secure throughout the procedure

Typical properties

Additional Drapes: Sheet

Brands: Steri-Drape™

Factory ISO Certification: No ISO Certification information available

Product Type: Drape Sheet

Product Use: Surgical Sheet

Dimensions and Classifications

Overall Length (Metric): 228 cm

Overall Width (Metric): 300 cm

3M™ Avagard™ Hands Free Wall Dispenser 9228, 4 Each/Case

3M ID 7000030324 UPC 50707387580518

Details

Use with 9200 or 9216 wedge bottles

Typical properties

Accessory Type: Hand Pump

Brands: Avagard™

Dispensing System: Hand Pump

Factory ISO Certification: No ISO Certification information available

Model: 9228

Product Type: Dispenser & Accessory

Product Use: Accessory, Wall Bracket

eClass 14 Classification Group: 20420207

3M™ Bair Hugger™ Flex Warming Gown Kit

Details

Two inserts allow for greater warming flexibility: upper, torso or lower body warming; clinical or comfort warming
Patients reach the OR ready to warm with warming tools built right into the gown including a head drape, tie strips and a patient adhesive

Typical properties

Brands: Bair Hugger™
Clinical Area: OR, PACU, Pre-op
Factory ISO Certification: No ISO Certification information available
Gown Circumference (Metric): 163 cm
Model: 84003, 84203
Product Type: Gown Kit
Quantity: 20 Case, 30 Case
Size: Standard, X-Large
Style: Flex Gown
Sweep: 122 in +/- 1, 64 in +/- 1
Sweep (Metric): 163 , 310
Units per Pack: 30
eClass 14 Classification Group: 34540392

Dimensions and Classifications

Overall Length (Imperial): 51 in
Overall Length (Metric): 130 cm
Overall Width (Metric): 130 cm

3M™ Bair Hugger™ Warming Blanket 54200, Dual Port Torso, 10/Case

3M ID 7100212598 UPC 50707387790139

Details

Single-use upper-body forced-air warming blanket with 2 convenient resealable hose ports provides excellent heat transfer
Consists of a soft, comfortable, lightweight, material with natural dry rubber latex not present as a material of construction
Can

Typical properties

Application: Medical
Blanket Type: Torso
Brands: Bair Hugger™
Clinical Area: OR
Drape Length: 24 in
Drape Length (Metric): 61 cm
Drape Width: 16 in
Drape Width (Metric): 41 cm
Factory ISO Certification: No ISO Certification information available
Product Type: Blanket
Quantity: 10 Case
Total Units per Case: 10 per Case
Units per Pack: 10
eClass 14 Classification Group: 34540392

Dimensions and Classifications

Overall Length (Imperial): 42 in
Overall Length (Metric): 107 cm
Overall Width (Imperial): 36 in
Overall Width (Metric): 91 cm

3M™ Bair Hugger™ Warming Blanket, 56000, Cath Lab

3M ID B00042329

Details

Can be used in supine, prone, lithotomy and other patient positions

Typical properties

Brands: Bair Hugger™

eClass 14 Classification Group: 34540392

3M™ CoTran™ Backing Polyethylene Monolayer Backing Film, 9719, Config Roll

3M ID 7100065958

Details

Translucent
Breathable
Highly conformable
Controlled caliper

Typical properties

Backing (Carrier) Material: Polyethylene
Brands: CoTran™
Caliper: 1.7 mils
Caliper (Metric): 43.2 µm
Catalog Number: 9719
Elongation MD: 130%
Factory ISO Certification: No ISO Certification information available
MVTR (g/m²/24 hr): 9.1
Oxygen Transmission (cc/m²/24hr): 9660
Product Type: Transdermal Backing
Sample Roll: 6 in x 25 yds
Sample Roll (Metric): 15 cm x 23 m
Tensile MD: 2.2 lbs/in
Tensile MD (Metric): 9.8 N/25.4 mm
eClass 14 Classification Group: 41011103

Dimensions and Classifications

Overall Length (Imperial): 2000 yd
Overall Length (Metric): 1827 m
Overall Width (Imperial): 48 in
Overall Width (Metric): 122 cm

3M™ Steri-Drape™ Back Table Cover, 9072, 39 in x 59 in, 20/Carton, 4 Cartons/Case

3M ID 7000002690 UPC 50707387784725

Details

Impervious to Strikethrough
Fluid Control Features
Meets flammability class 1 (CFR Title 16 Part 1610)

Typical properties

Additional Drapes: Sheet
Brands: Steri-Drape™
Clinical Area: Surgery
Clinical Sub-Area: Obstetrics and Gynaecology, Orthopedics
Factory ISO Certification: No ISO Certification information available
Incise Area Width (Metric): 43 cm
Material: Fabric
Model: 9072
Procedure: General Surgery
Product Color: Blue
Product Type: Table Cover
Product Type Free Format: Drape
Product Use: Surgical Sheet
Sterile: Yes
Units per Pack: 20

Dimensions and Classifications

Overall Length (Imperial): 39 in
Overall Length (Metric): 100 cm
Overall Width (Imperial): 59 in
Overall Width (Metric): 150 cm

3M™ Medical Silicone Tape 2476P, Single Sided Polyester Spunlace Nonwoven, Configurable

3M ID 7100013596

Details

Silicone Adhesive
Repositionable
Breathable
Fluid Resistant

Typical properties

Adhesive Type: Silicone
Backing Caliper: 10.6 mil
Backing Caliper (Metric): 270 Micron
Backing Material: Polyester Spunlace
Backing Thickness (Imperial): 10.6 mil
Backing Thickness (Metric): 270 Micron
Brands: 3M™
Breathable: Yes
Conformability: High
Factory ISO Certification: No ISO Certification information available
Fluid Resistance Backing/Carrier: Yes
Hypoallergenic: No
Latex: No
Liner Caliper (Metric): 90 Micron
Liner Caliper (mils): 3.5 mil
Liner Color: Clear
Liner Material: Polypropylene
Material: Spunlace Non-woven
Maximum Length (Metric): 183 m
Maximum Width Capacity: 24 in
Maximum Width Capacity (Metric): 610 mm
Printable Backing: No
Product Color: White
Product Type: Non-woven Polyester & Polyester Blend Tape
Product Usage: Adhesion to Skin
Sterilization Method: Ethylene Oxide (EO)
Tape Color: White
Tape Total Caliper: 14.6 mil
Tape Total Caliper (Metric): 370.0 Micron
Tape Type: Single Sided Spunlace Nonwoven Tape
eClass 14 Classification Group: 34180101

Dimensions and Classifications

Overall Thickness (Imperial): 3.6 mil
Overall Thickness (Metric): 0.37 mm
Overall Width (Imperial): 12 in
Overall Width (Metric): 30.48 cm

3M™ CoTran™ Melt-Blown Polyurethane Tape, 9699, Configurable

3M ID 7100119879

Details

Tan
Breathable
Highly conformable
Pressure sensitive acrylate adhesive

Typical properties

Backing (Carrier) Material: Polyurethane
Brands: CoTran™
Caliper: 10 mils
Caliper (Metric): 254 µm
Catalog Number: 9699
Elongation CD: 300%
Elongation MD: 300%
Factory ISO Certification: No ISO Certification information available
Liner Caliper (Metric): 114 µm
Liner Release: ≤200 g/in
Liner Release (Metric): ≤1.96 N/25.4 mm/in
MVTR (g/m²/24 hr): 8000
Product Color: Tan
Product Type: Transdermal Tape
Sample Roll: 6 in x 25 yds
Sample Roll (Metric): 15 cm x 23 m
Tape Total Caliper: 14.5 mils
Tape Total Caliper (Metric): 368 µm
Tensile CD: 1.6 lbs/in
Tensile CD (Metric): 7.1 N/25.4 mm
Tensile MD: 2.8 lbs/in
Tensile MD (Metric): 12.5 N/25.4 mm
eClass 14 Classification Group: 41011103

Dimensions and Classifications

Overall Length (Imperial): 410 yd
Overall Length (Metric): 375 m
Overall Width (Imperial): 50 in
Overall Width (Metric): 127 cm

3M™ Bair Hugger™ Temperature Control Holder, Model 90073, 1 EA

3M ID 7100087540 UPC 00707387774868

Details

Holds temperature controller so that it is easily accessible to the patient and clinician

Typical properties

Brands: Bair Hugger™

Cladimed Code: F59ZZ99

Factory ISO Certification: No ISO Certification information available

Product Type: Accessory

eClass 14 Classification Group: 34540391

Dimensions and Classifications

Overall Height (Imperial): 1.75 in

Overall Height (Metric): 4.4 cm

Overall Width (Imperial): 2.5 in

Overall Width (Metric): 6.4 cm

3M™ Ranger™ Cleaning Tool Accessory, Model 90030, 12/Case

3M ID 7100092605 UPC 50707387781946

Details

Convenient
Easy-to-use

Typical properties

Brands: Ranger™
Cladimed Code: Non applicable
Clinical Area: ER, OR
Factory ISO Certification: No ISO Certification information available
Fluid Type: Irrigation Fluid
Model: 90030
Product Type: Accessory
Quantity: 12 Case
Units per Pack: 12

3M™ 9969 Diagnostic Microfluidic Adhesive Transfer Medical Tape

3M ID 7100116011 UPC 00707387771133

Details

For general medical device use
Lateral flow blood glucose monitoring test strips
Transfer tape for test strip applications
Can be used in 'Lab-on-a-chip' diagnostic consumable constructions
May be integrated with additional 3M technologies and medical

Typical properties

Brands: 3M™
Breathable: No
Conformability: Medium
Factory ISO Certification: No ISO Certification information available
Liner Material: Polyester
Printable Backing: No
Product Type: Spacer Tape
Product Usage: Diagnostic Medical Device
Tape Type: Spacer Tape
eClass 14 Classification Group: 15360503

Dimensions and Classifications

Overall Width (Imperial): 48 in
Overall Width (Metric): 121.92 cm

3M™ Micropore™ S Surgical Tape, 277X Series

Details

Reliable adhesion: Good initial and long term (72 hours) adhesion to skin
Skin performance: Delivers the securement power you need while minimizing damage to skin
Easy to use: Can be torn by hand and repositioned
Helps reduce risk: Individually package

Typical properties

Approved Environmental Marketing Claim (EMC): Micropore™ S Silicone Tape uses a solvent-free adhesive
Brands: Micropore™
Environmental claim being made: Yes
Environmental claim relates to: Product
Evidence for Claim: Self Certified
Factory ISO Certification: No ISO Certification information available
Hypoallergenic: Yes
Product Color: Blue
Product Type: Medical Tape
Units per Pack: 6 , 12 , 50 , 100

Dimensions and Classifications

Overall Length (Imperial): 1.5 yd, 5.5 yd, 18 in
Overall Length (Metric): 1.3 m, 5 m, 45 cm
Overall Width (Imperial): 1 in, 2 in
Overall Width (Metric): 2.54 cm, 5.08 cm

3M™ SoluPrep™ S Sterile Antiseptic Solution 2% CHG / 70% IPA

Details

Provides rapid, broad-spectrum antimicrobial activity* and persistence for at least 96 hours ** (1)

FDA-approved 2% chlorhexidine gluconate and 70% isopropyl alcohol sterile solution (2) and sterile applicator (3)

Brite Green tint provides visibility of

Typical properties

Antiseptic Agent: CHG/IPA

Brands: SoluPrep™

Catalog Number: 67133,67134,67130

Factory ISO Certification: No ISO Certification information available

Product Color: Green

Product Type: Surgical Prep

Product Use: Surgical

Volume (Imperial): 0.355 fl oz, 0.879 fl oz

Volume (Metric): 10.5 mL, 26 mL

eClass 14 Classification Group: 34210190

3M™ Attest™ Mini Auto-Reader, 490M, 1 Each/Case

3M ID 7100215093 UPC 50707387790702

Details

4-well dual auto-reader designed for use with 3M™ Attest™ Super Rapid Readout Biological Indicator 1491 for Steam Sterilization, 3M™ Attest™ Super Rapid Readout Biological Indicator 1492V for Steam Sterilization and 3M™ Attest™ Rapid Readout Biological In

Typical properties

Biological Indicator System: Super Rapid
Brands: Attest™
Catalog Number: 490M
Compatible Indicator: 1295, 1491, 1492V
Factory ISO Certification: No ISO Certification information available
Incubation Period: 24 Minute
Maximum Temperature (Celsius): 60 °C
Maximum Temperature (Fahrenheit): 140 °F
Number of Wells: 4
Product Type: Incubator
Sterilization Method: Hydrogen Peroxide, Steam
Total Units per Case: 1 per Case

Dimensions and Classifications

Overall Height (Imperial): 3.2 in
Overall Length (Imperial): 6.1 in

3M™ Promogran Prisma™ Collagen Matrix with ORC and Silver

Details

Unlike any other collagen dressing
3M™ Promogran™ Matrix Family is the most studied collagen dressing in the world
Promogran Matrix Family is the only collagen dressing uniquely formulated with Oxidized Regenerated Cellulose (ORC)
Is effective against

Typical properties

Boxes per Case: 4.0
Brands: Promogran Prisma™
Catalog Number: MA032,MA123,MA028
Factory ISO Certification: No ISO Certification information available
HCPCS Code: A6021, A6022, A6024
Inner Packs per Case: 4 Cartons per Case
Product Form: Hexagon, Rope
Surface Area (Imperial): 4.34 in², 19.1 in²
Surface Area (Metric): 28 cm², 123 cm²
Total Units per Case: 24 per Case, 40 per Case
Units per Inner Pack: 6 per Carton, 10 per Carton

Dimensions and Classifications

Overall Length (Imperial): 12.625 in
Overall Length (Metric): 32 cm
Overall Thickness (Imperial): 0.375 in
Overall Thickness (Metric): 1 cm
Overall Width (Imperial): 0.375 in
Overall Width (Metric): 1 cm

3M™ Adaptic™ Digit Non-Adhering Dressing

Details

Conformable digit dressing allowing for maximum digit flexibility
Easy to apply and helps minimise trauma associated with dressing changes¹
No secondary retention necessary
May be left in place for several days

Typical properties

Brands: Adaptic™
Factory ISO Certification: No ISO Certification information available
eClass 14 Classification Group: 34210402

Dimensions and Classifications

Overall Length (Metric): 2 cm, 2.4 cm, 2.8 cm, 3 cm

3M™ AbThera™ Advance Open Abdomen Dressing

3M ID B5005265106

Details

Actively removes fluid and helps reduce edema

Provides medial tension which helps minimize fascial retraction and loss of domain

Provides separation between the abdominal wall and viscera, protecting abdominal contents

Protects abdominal contents from

Typical properties

Brands: AbThera™

Factory ISO Certification: No ISO Certification information available

3M™ Prevena™ Peel and Place Incision Management System

Details

Available with two dressing options: 13cm (for linear incisions up to 13cm in length) & 20cm (for linear incisions up to 20cm in length)

The 3M™ Prevena™ 125 Therapy Unit provides pre-set, continuous NPWT at -125mmHg

The 3M™ Prevena™ 125 Therapy Unit is

Typical properties

Brands: Prevena™

Factory ISO Certification: No ISO Certification information available

Product Type: 7-day Pump

Dimensions and Classifications

Overall Length (Imperial): 5.984 in, 10 in

Overall Length (Metric): 15.2 cm, 25.4 cm

Overall Width (Imperial): 0.709 in

Overall Width (Metric): 1.8 cm

3M™ V.A.C.® Simplace™ EX Dressing

3M ID B5005265142

Details

No scissors necessary

Design allows for easier bridging

Utilizes 3M™ V.A.C.® Granufoam™ Dressing material redesigned in a spiral-cut foam

Precut 3M™ V.A.C.® Drape Strips provide easier application and fewer steps for bridging

3M™ V.A.C.® Simplace™ EX

Typical properties

Brands: V.A.C.®

Factory ISO Certification: No ISO Certification information available

Size: Medium, Small

eClass 14 Classification Group: 34210701

3M™ Nasogastric Securement Device

Details

Reliable securement: Adhesive stays in place in challenging locations for up to 48 hours

Skin performance: Designed to help reduce the risk of pressure injury by allowing the NG tube to hang freely* *Data collected during a US customer preference evaluation

Typical properties

Boxes per Case: 4.0

Brands: 3M™

Catalog Number: 1501NG,1500NG

Factory ISO Certification: No ISO Certification information available

Size: Large, Small

Units per Case: 200.0

Units per Pack: 50

eClass 14 Classification Group: 34180202

Dimensions and Classifications

Overall Length (Imperial): 1.75 in, 2.25 in

Overall Length (Metric): 4.5 cm, 5.7 cm

Overall Width (Imperial): 1.88 in, 2.88 in

Overall Width (Metric): 4.7 cm, 7.3 cm

3M™ Steri-Drape™ Bilateral Split Sheet 9046

3M ID 7000053582 UPC 50707387456325

Details

Resistant to Strikethrough
Reliable, dependable adhesive
Fluid Control Features
Reliable, dependable adhesive (around aperture, etc.) stays secure throughout the procedure

Typical properties

Additional Drapes: Sheet
Brands: Steri-Drape™
Cladimed Code: E51BA99
Factory ISO Certification: No ISO Certification information available
Loophole Length (Metric): 15 cm
Loophole Width (Metric): 35 cm
Model: 9046
Procedure: Cardiovascular, Orthopedic
Product Type: Split Sheet
Product Type Free Format: Drape
Product Use: Surgical Sheet
Therapeutic Area and Conditions: Cardiovascular
Units per Pack: 15

Dimensions and Classifications

Overall Length (Imperial): 78 in
Overall Length (Metric): 200 cm
Overall Width (Imperial): 72 in
Overall Width (Metric): 183 cm

3M™ Surgical Clipper with Pivoting Head, 9662L, 1/Case

3M ID 7100219369 UPC 00707387791469

Details

Convenient, drop-in charger stand
Clipper stand/charger for clipper body, 9661L
Four hour recharge time

Typical properties

Brands: 3M™
Factory ISO Certification: No ISO Certification information available
Model: 9662L
Product Type: Charger
Therapeutic Area and Conditions: Pre-Operative Hair Removal
Units per Pack: 1
eClass 14 Classification Group: 47040590

3M™ Surgical Clipper with Pivoting Head, 9661L, 1 Each/Case

3M ID 7100213034 UPC 00707387789725

Details

Has a nick rate of less than 2 percent, helping to reduce the risk of SSIs.1
Approximately 160 minutes of run time on a four-hour recharge
Ergonomic design that's easy to hold
Battery indicator light shows when it's time to recharge
Also available: the

Typical properties

Brands: 3M™
Factory ISO Certification: No ISO Certification information available
Head Type: Pivoting
Model: 9661L
Product Color: Purple
Product Type: Clipper
Therapeutic Area and Conditions: Pre-Operative Hair Removal
Total Units per Case: 1 per Case
Units per Pack: 1
eClass 14 Classification Group: 47040590

3M™ Microfluidic Diagnostic Tape 9965, Double Sided White Tape, CONFIGURABLE

3M ID 7100067080

Details

- Hydrophobic adhesive resists clouding
- Adheres to a wide variety of substrates
- White polyester carrier
- Double sided adhesive coating
- Non-hemolytic
- Non-toxic to mammalian cells
- Low extractables

Typical properties

- Brands: 3M™
- Factory ISO Certification: No ISO Certification information available
- eClass 14 Classification Group: 34180101

Dimensions and Classifications

- Overall Width (Imperial): 48 in
- Overall Width (Metric): 121.92 cm

3M™ Medical Tape 1533, Single Sided Microporous Tan Rayon Nonwoven Fabric, W/O Liner, Configurable

3M ID 7100003043

Details

Acrylic Adhesive
Breathable
Printable
Good Processability

Typical properties

Adhesive Material: Acrylate
Adhesive Type: Acrylic/Acrylate
Backing (Carrier) Material: Rayon Non-woven
Brands: 3M™
Breathable: Yes
Conformability: Medium
Factory ISO Certification: No ISO Certification information available
Fluid Resistance Backing/Carrier: No
Hypoallergenic: No
Latex: No
Liner Material: None
Material: Rayon Non-woven
Maximum Length (Metric): 777 m
Maximum Width Capacity: 48 in
Maximum Width Capacity (Metric): 1220 mm
Printable Backing: Yes
Product Color: Tan
Product Type: Rayon Non-woven
Product Usage: Adhesion to Skin
Sterilization Method: Ethylene Oxide (EO), Gamma
Tape Color: Tan
Tape Total Caliper: 5.5 mil
Tape Total Caliper (Metric): 140.0 Micron
Tape Type: Single Sided Rayon Nonwoven Fabric Tape
eClass 14 Classification Group: 34180201

Dimensions and Classifications

Overall Thickness (Imperial): 4.9 mil
Overall Thickness (Metric): 0.14 mm
Overall Width (Imperial): 48 in
Overall Width (Metric): 121.92 cm

3M™ Attest™ Super Rapid Vaporized H₂O₂ Biological Indicator, 1295, Pink Cap, 24 min, 30/BAG, 4 BAG/CS, 120/CS

3M ID 7100046532 UPC 10707387769748

Details

Fast BI results in 24 minutes

ISO 11138-1:2017 compliant Biological Indicator for VH₂O₂

For use in all currently marketed STERRAD® and V-PRO® sterilizers in global healthcare facilities

Compatible with 3M™ Attest™ Auto-reader 490 or 490M

Interested in

Typical properties

Biological Indicator System: Super Rapid

Brands: Attest™

Cap Color: Pink

Catalog Number: 1295

Cladimed Code: E52IC02

Factory ISO Certification: No ISO Certification information available

Incubation Period: 24 Minute

Inner Packs per Case: 4 Bags per Case

Product Type: Biological Indicator

Product Use: Load Monitoring

Sterilization Method: Hydrogen Peroxide

Total Units per Case: 120 per Case

Units per Inner Pack: 30 per Bag

eClass 14 Classification Group: 34410601

3M™ Comply™ Hydrogen Peroxide Indicator Tape 1228

3M ID 7000002742 UPC 00707387508289

Details

Non-cellulosic plastic backing material with a pressure-sensitive adhesive on one side and chemical indicator stripes on the other side

For use in STERRAD® 100 System, STERRAD® 100S System, STERRAD® NX® System (Standard and Advanced cycles), STERRAD® 100

Typical properties

Brands: Comply™

Cladimed Code: E52IA01

Factory ISO Certification: No ISO Certification information available

Model: 1228

Product Type: Indicator Tape

Product Use: Exposure Monitoring

Sterilization Method: Hydrogen Peroxide

eClass 14 Classification Group: 34410301

Dimensions and Classifications

Overall Length (Imperial): 60 yd

Overall Length (Metric): 55 m

Overall Width (Imperial): 0.75 in

Overall Width (Metric): 19 mm

3M™ Comply™ VH₂O₂ Chemical Indicator Strip, 1248, Type 1, 13/16 in x 4 in (2 cm x 10 cm), 250/BAG, 4 BAG/CS, 1000/CS

3M ID 7000002743 UPC 50707387508291

Details

Chemical indicator bar turns from blue to pink to indicate vaporized hydrogen peroxide (VH₂O₂) exposure
Offers easy-to-read method of monitoring packs in the sterilization process
Chemical indicator does not fade due to light exposure
Two (2) year shelf

Typical properties

Brands: Comply™
Catalog Number: 1248
Cladimed Code: Non applicable
Factory ISO Certification: No ISO Certification information available
Inner Packs per Case: 4 Bags per Case
Product Type: Chemical Indicator
Product Use: Pack Monitoring
Sterilization Method: Hydrogen Peroxide
Total Units per Case: 1000 per Case
Units per Inner Pack: 250 per Bag
eClass 14 Classification Group: 34410401

Dimensions and Classifications

Overall Length (Imperial): 4 in
Overall Length (Metric): 10 cm
Overall Width (Imperial): 0.8125 in
Overall Width (Metric): 2 cm

3M™ Medical Tape 1530, Single Sided Microporous Rayon Nonwoven Fabric, Without Liner, Configurable

3M ID 7100009942

Details

Acrylic Adhesive
Breathable
Good Processability

Typical properties

Adhesive Material: Acrylate
Adhesive Type: Acrylic/Acrylate
Backing (Carrier) Material: Rayon Non-woven
Brands: 3M™
Breathable: Yes
Conformability: Medium
Factory ISO Certification: No ISO Certification information available
Fluid Resistance Backing/Carrier: No
Hypoallergenic: No
Liner Material: None
Material: Rayon Non-woven
Maximum Length (Metric): 777 m
Maximum Width Capacity: 48 in
Maximum Width Capacity (Metric): 1220 mm
Printable Backing: Yes
Product Color: White
Product Type: Rayon Non-woven
Product Usage: Adhesion to Skin
Sterilization Method: Ethylene Oxide (EO), Gamma
Tape Color: White
Tape Total Caliper: 5.5 mil
Tape Total Caliper (Metric): 140.0 Micron
Tape Type: Single Sided Rayon Nonwoven Fabric Tape
eClass 14 Classification Group: 34180201

Dimensions and Classifications

Overall Thickness (Imperial): 0.04 in
Overall Thickness (Metric): 0.14 mm
Overall Width (Imperial): 48 in
Overall Width (Metric): 121.92 cm

3M™ Medical Tape 9916, Single Sided Spunlaced Nonwoven Fabric, 62# Liner, Configurable

3M ID 7100000229

Details

Acrylic Adhesive
Breathable
Conformable
Printable

Typical properties

Adhesive Material: Acrylate
Adhesive Type: Acrylic/Acrylate
Backing (Carrier) Material: Spunlace Non-woven
Brands: 3M™
Breathable: Yes
Conformability: High
Factory ISO Certification: No ISO Certification information available
Fluid Resistance Backing/Carrier: No
Hypoallergenic: No
Latex: No
Liner Caliper (Metric): 120 Micron
Liner Caliper (mils): 4.9 mil
Liner Color: White
Liner Material: Paper
Liner Weight: 62.0 lb.
Liner Weight (Metric): 101 g/m²
Material: Spunlace Non-woven
Maximum Length (Metric): 183 m
Maximum Width Capacity: 46 in
Maximum Width Capacity (Metric): 1170 mm
Printable Backing: Yes
Product Color: Tan
Product Type: Non-woven Polyester & Polyester Blend Tape
Product Usage: Adhesion to Skin
Sterilization Method: Ethylene Oxide (EO), Gamma
Tape Color: Tan
Tape Total Caliper: 15.0 mil
Tape Total Caliper (Metric): 380.0 Micron
Tape Type: Single Sided Spunlace Nonwoven Tape
eClass 14 Classification Group: 34180201

Dimensions and Classifications

Overall Thickness (Imperial): 1.02 in
Overall Thickness (Metric): 0.38 mm
Overall Width (Imperial): 46 in
Overall Width (Metric): 116.84 cm

3M™ Steam Log Book 1266

Part Number 1266 3M ID 7000053695 UPC 00707387044978

Details

Black color printing on the binder and chart enable it to be used to record the results of either 3M™ Attest™ Rapid Readout BI #1291 or #1292

Typical properties

Brands: 3M™

Factory ISO Certification: No ISO Certification information available

Model: 1266

Product Type: Log Book

Product Use: Record Keeping

Sterilization Method: Steam

eClass 14 Classification Group: 34410209

Dimensions and Classifications

Overall Height (Imperial): 9.125 in

Overall Length (Imperial): 6.375 in

Overall Width (Imperial): 1.125 in

3M™ Medical Tape 1527LX, Single Sided Transparent Ethylene Vinyl Acetate Perforated, 83# Liner, Configurable

3M ID 7100090413

Details

Tackified Acrylic Adhesive
Tear by Hand
Semi-Perforated
Good Processability
Diecuttable for converting

Typical properties

Adhesive Material: Acrylate
Adhesive Type: Acrylic/Acrylate (Tack)
Backing Caliper: 4.8 mil
Backing Caliper (Metric): 120 Micron
Backing Material: Polyolefin
Backing Thickness (Imperial): 4.8 mil
Backing Thickness (Metric): 120 Micron
Brands: 3M™
Breathable: Yes
Conformability: Medium
Factory ISO Certification: No ISO Certification information available
Fluid Resistance Backing/Carrier: No
Hypoallergenic: No
Liner Caliper (Metric): 150 Micron
Liner Caliper (mils): 6 mil
Liner Color: White
Liner Material: Paper
Liner Weight: 83.0 lb.
Liner Weight (Metric): 135 g/m²
Material: Polyolefin
Maximum Length (Metric): 320 m
Maximum Width Capacity: 48 in
Maximum Width Capacity (Metric): 1220 mm
Printable Backing: No
Product Color: Transparent
Product Type: Polyethylene
Product Usage: Adhesion to Skin, Adhesion to Substrate
Sterilization Method: Ethylene Oxide (EO), Gamma
Tape Color: Transparent
Tape Total Caliper: 7.4 mil
Tape Total Caliper (Metric): 190.0 Micron
Tape Type: Single-sided Polyolefin Tape
eClass 14 Classification Group: 34180101

Dimensions and Classifications

Overall Thickness (Imperial): 1 in

Overall Thickness (Metric): 0.19 mm
Overall Width (Imperial): 48 in
Overall Width (Metric): 121.92 cm

3M™ Medical Tape 9917, Double Sided Spunlaced Nonwoven Fabric, 62# Liner, Configurable

3M ID 7100000230

Details

Acrylic Adhesive
Breathable
Conformable
Good Processability

Typical properties

Adhesive Material: Acrylate
Adhesive Type: Acrylic/Acrylate
Backing (Carrier) Material: Spunlace Non-woven
Brands: 3M™
Breathable: Yes
Conformability: High
Factory ISO Certification: No ISO Certification information available
Fluid Resistance Backing/Carrier: No
Hypoallergenic: No
Latex: No
Liner Caliper (Metric): 90 Micron
Liner Caliper (mils): 3.5 mil
Liner Color: White
Liner Material: Paper
Liner Weight: 62.0 lb.
Liner Weight (Metric): 101 g/m²
Material: Spunlace Non-woven
Maximum Length (Metric): 366 m
Maximum Width Capacity: 48 in
Maximum Width Capacity (Metric): 1220 mm
Printable Backing: No
Product Color: White
Product Type: Double Sided Tape
Product Usage: Adhesion to Skin, Adhesion to Substrate
Sterilization Method: Ethylene Oxide (EO), Gamma
Tape Color: White
Tape Total Caliper: 12.0 mil
Tape Total Caliper (Metric): 300.0 Micron
Tape Type: Double Sided Spunlace Tape
eClass 14 Classification Group: 34180201

Dimensions and Classifications

Overall Thickness (Imperial): 1.02 in
Overall Thickness (Metric): 0.3 mm
Overall Width (Imperial): 48 in
Overall Width (Metric): 121.92 cm

3M™ Microfluidic Diagnostic Film 9962, Thin Double Sided Hydrophilic Film, CONFIGURABLE

3M ID 7100012434

Details

- Hydrophilic
- Transparent
- In vitro Hemocompatibility
- Low Autofluorescence
- Dimensionally Stable
- Non-toxic to mammalian cells
- No significant outgassing <400°C
- Anti-fogging properties
- Non-leaching hydrophilic coating technology

Typical properties

- Brands: 3M™
- Factory ISO Certification: No ISO Certification information available
- eClass 14 Classification Group: 34180101

Dimensions and Classifications

- Overall Width (Imperial): 48 in
- Overall Width (Metric): 121.92 cm

3M™ Medical Tape 1521, Single Sided Transparent Polyethylene, 83# Liner, Configurable

3M ID 7100013875

Details

Acrylic Adhesive
Fluid Resistant
Good Processability

Typical properties

Adhesive Material: Acrylate
Adhesive Type: Acrylic/Acrylate (Tack)
Backing Caliper: 5 mil
Backing Caliper (Metric): 130 Micron
Backing Material: Polyethylene
Backing Thickness (Imperial): 5 mil
Backing Thickness (Metric): 130 Micron
Brands: 3M™
Breathable: No
Conformability: Medium
Factory ISO Certification: No ISO Certification information available
Fluid Resistance Backing/Carrier: Yes
Hypoallergenic: No
Liner Caliper (Metric): 150 Micron
Liner Caliper (mils): 6 mil
Liner Color: White
Liner Material: Paper
Liner Weight: 83.0 lb.
Liner Weight (Metric): 135 g/m²
Material: Polyethylene
Maximum Length (Metric): 329 m
Maximum Width Capacity: 48 in
Maximum Width Capacity (Metric): 1220 mm
Printable Backing: Yes
Product Color: Transparent
Product Type: Polyethylene
Product Usage: Adhesion to Skin, Adhesion to Substrate
Sterilization Method: Ethylene Oxide (EO), Gamma
Tape Color: Transparent
Tape Total Caliper: 6.3 mil
Tape Total Caliper (Metric): 160.0 Micron
Tape Type: Single-sided Polyethylene Tape
eClass 14 Classification Group: 34180101

Dimensions and Classifications

Overall Thickness (Imperial): 2.6 mil
Overall Thickness (Metric): 0.16 mm
Overall Width (Imperial): 48 in

3M™ Surgical Clipper with Pivoting Head, 9667L, 1/Case

3M ID 7100219367 UPC 00707387791490

Details

Kit contains 9661L body and 9662L charger stand (blade assembly not included)
Reduces risk of nicks or cuts with the away-from-the-skin cutting blade position
Easily clean handle by rinsing under running water and wiping with a disinfectant
Convenient,

Typical properties

Brands: 3M™
Factory ISO Certification: No ISO Certification information available
Model: 9667L
Product Type: Charger Kit
Therapeutic Area and Conditions: Pre-Operative Hair Removal
Units per Pack: 1
eClass 14 Classification Group: 47040590

3M™ Steri-Drape™ Small Drape with Incise Film, 1021, 40 cm x 40 cm (15 in x 15 in), 10/Carton, 4 Cartons/Case

3M Product Number 1021 3M ID 7000053444 UPC 30707387058204

Details

Impervious polyethylene film provides a barrier to liquids, reducing exposure to blood and body fluids

Adhesive film isolates the surgical site from lid margins, eyelashes, and eyebrows to help reduce the risk of surgical site contamination

Matte finish

Typical properties

Accessories: Miscellaneous

Brands: Steri-Drape™

Cladimed Code: E51BA99

Factory ISO Certification: No ISO Certification information available

Features: Clear

Incise Area Length (Metric): 10 cm

Incise Area Width (Metric): 12.5 cm

Material: Plastic

Model: 1021

Procedure: EENT

Product Color: Transparent

Product Type: Ophthalmic Drape

Product Type Free Format: Drape

Product Use: EENT

Sterile: Yes

Therapeutic Area and Conditions: General Surgery, Ophthalmic

Units per Pack: 10

Dimensions and Classifications

Overall Length (Imperial): 15 in

Overall Length (Metric): 40 cm

Overall Width (Imperial): 15 in

Overall Width (Metric): 40 cm

3M™ Steri-Drape™ Gynecological Drape with Pouch 1080

3M ID 7100002165 UPC 30707387381777

Details

Absorbent throughout entire drape
Resistant to Strikethrough
Fluid Control Features

Typical properties

Brands: Steri-Drape™
Cladimed Code: E51BH04
Factory ISO Certification: No ISO Certification information available
Model: 1080
Procedure: Obstetrics and Gynaecology
Product Type: Gynecology Drape
Product Type Free Format: Drape
Product Use: Gynecology
Therapeutic Area and Conditions: Obstetrics and Gynaecology, Urology
Units per Pack: 14

Dimensions and Classifications

Overall Length (Imperial): 70 in
Overall Length (Metric): 179 cm
Overall Width (Imperial): 77 in
Overall Width (Metric): 195 cm

3M™ Surgical Clipper with Pivoting Head, 9660, 50/Case

3M ID 7100213114 UPC 50707387789003

Details

Conforms to contours of patient's body
Adjustable head allows clipping with a pull or push motion
Reduces risk of cross-contamination with single-use blades
Blade easily snaps-on and pops-off

Typical properties

Brands: 3M™
Cladimed Code: F52AB01
Factory ISO Certification: No ISO Certification information available
Head Type: Pivoting
Model: 9660
Product Color: Purple
Product Type: Clipper
Therapeutic Area and Conditions: Pre-Operative Hair Removal
Units per Pack: 50
eClass 14 Classification Group: 47040590

3M™ Avagard™ Floor Stand, 9244, 1EA/CS

3M ID 7000054136 UPC 00707387766986

Details

No Tools required to assemble stand*

Made of powder coated steel

Easy to clean drip tray

Self-righting base, up to 40 degrees past center (without dispenser)

*Tools required to mount dispenser

Typical properties

Accessory Type: Hand Pump

Brands: Avagard™

Dispensing System: Hand Pump

Factory ISO Certification: No ISO Certification information available

Model: 9244

Product Type: Dispenser, Bracket & Accessory

Product Use: Accessory

eClass 14 Classification Group: 20420207

3M™ Bair Hugger™ Temperature Monitoring Patient Sensor, 36000, 25/Case

3M ID 7100236253 UPC 50707387792959

Details

Single patient use sensor applied in pre-op, remains on patient through perioperative journey

Provides accurate core temperature measurement

The sensor stays on the patient, as it is disconnected from the sensor cable and reconnected at each point of ca

Typical properties

Accuracy: 25°C to 43°C ± 0.2°C

Brands: Bair Hugger™

Cladimed Code: K50BC11

Clinical Area: OR, PACU, Pre-op

Factory ISO Certification: No ISO Certification information available

Model: 36000

Product Type: Sensor

Quantity: 25 Case

eClass 14 Classification Group: 34540391

Dimensions and Classifications

Overall Diameter (Imperial): 1.6 in

Overall Diameter (Metric): 4.1 cm

Overall Height (Imperial): 0.2 in

Overall Height (Metric): 0.5 cm

3M™ Microfluidic Diagnostic Tape 9795R, Single Sided Clear Delayed Tack Adhesive Tape , CONFIGURABLE

3M ID 7100224806

Details

- Optically clear
- Bioassay compatible adhesive (based on compatibility with industry typical reagents)
- Chemically inert
- Low autofluorescence
- Adheres to a wide variety of substrates
- Delayed tack adhesive
- Low extractables
- Non-hemolytic
- Non-toxic to m

Typical properties

- Brands: 3M™
- Factory ISO Certification: No ISO Certification information available
- eClass 14 Classification Group: 34180101

Dimensions and Classifications

- Overall Width (Imperial): 48 in
- Overall Width (Metric): 121.92 cm

3M™ Medical Film 9832F, Polyurethane on White 78# Carrier, CONFIGURABLE

3M ID 7100102225

Details

Translucent
High Moisture Vapor Transmission Rate (MVTR) / Breathability
Fluid Resistant
Printable with treatment

Typical properties

Backing Caliper: 0.8 mil
Backing Caliper (Metric): 20 Micron
Backing Material: Polyurethane
Backing Thickness (Imperial): 0.8 mil
Backing Thickness (Metric): 20 Micron
Brands: 3M™
Breathable: Yes
Conformability: Very High
Factory ISO Certification: No ISO Certification information available
Fluid Resistance Backing/Carrier: Yes
Hypoallergenic: No
Latex: No
Liner Caliper (Metric): 130 Micron
Liner Caliper (mils): 5 mil
Liner Color: White
Liner Material: Paper
Liner Weight: 78.0 lb.
Liner Weight (Metric): 127 g/m²
Material: Polyurethane
Maximum Length (Metric): 640 m
Maximum Width Capacity: 46 in
Maximum Width Capacity (Metric): 1170 mm
Printable Backing: Yes
Product Color: Transparent
Product Type: Polyester, Incise & Polyurethane
Product Usage: Adhesion to Skin
Sterilization Method: Ethylene Oxide (EO), Gamma
Tape Color: Transparent
Tape Total Caliper: 0.8 mil
Tape Total Caliper (Metric): 20.0 Micron
Tape Type: Single-sided Polyurethane Tape
eClass 14 Classification Group: 34180101

Dimensions and Classifications

Overall Thickness (Imperial): 5 in
Overall Thickness (Metric): 0.02 mm
Overall Width (Imperial): 46 in

Overall Width (Metric): 121.92 cm

3M™ Comply™ Ethylene Oxide Chemical Indicator Strip, 1251, 5/8 in x 8 in (1.5 cm x 20 cm), 240/CAR, 1 CAR/CS, 240/CS

3M ID 7000002636 UPC 30707387106868

Details

Monitors all warm and cool cycles of 100% EO and EO/HCFC gas mixture sterilizer cycles
Immediate visual results (red to green color change) when exposed to critical parameters of the ethylene oxide sterilization process
Easy to handle during removal fro

Typical properties

Brands: Comply™
Catalog Number: 1251
Cladimed Code: Non applicable
Factory ISO Certification: No ISO Certification information available
Inner Packs per Case: 1 Cartons per Case
Product Type: Chemical Indicator
Product Type Free Format: Indicator Strip
Product Use: Pack Monitoring
Sterilization Method: Ethylene Oxide (EO)
Total Units per Case: 240 per Case
Units per Inner Pack: 240 per Carton
eClass 14 Classification Group: 34410401

Dimensions and Classifications

Overall Length (Imperial): 8 in
Overall Length (Metric): 20 cm
Overall Width (Imperial): 0.625 in
Overall Width (Metric): 1.5 cm

3M™ Avagard™ Universal Manual Wall Dispenser 9241

3M ID 7000053940 UPC 50707387761856

Details

Provides easy access to hand antiseptics

ADA compliant

Large window for viewing product level

ADA compliant

Helps create awareness of hand hygiene, a key critical factor influencing adherence to protocol.*

* Backed by CDC, Joint Commission and the 3M

Typical properties

Accessory Type: Hand Pump

Brands: Avagard™

Dispensing System: Hand Pump

Factory ISO Certification: No ISO Certification information available

Model: 9241

Product Type: Dispenser, Bracket & Accessory

Product Use: Accessory

eClass 14 Classification Group: 20420207

3M™ Medical Release Liner 9956, Polyester, Fluoropolymer, Configurable

3M ID 7100075835

Details

Easy release

Secondary or insertion liner for converting

Secondary or insertion liner for converting

Material and / or technology for health care or medical device construction

Typical properties

Brands: 3M™

Factory ISO Certification: No ISO Certification information available

eClass 14 Classification Group: 15360503

3M™ Microfluidic Diagnostic Tape 9793R, Single Sided Clear Polyolefin Tape, CONFIGURABLE

3M ID 7100000225

Details

- Hydrophobic adhesive resists clouding
- Adheres to a wide variety of substrates
- Transparent
- Low Autofluorescence
- Non-hemolytic
- Non-toxic to mammalian cells
- Low extractables

Typical properties

- Brands: 3M™
- Factory ISO Certification: No ISO Certification information available
- eClass 14 Classification Group: 34180101

3M™ Medical Foam Tape 9777L, Single Sided Polyvinyl Chloride, 72# liner, Configurable

3M ID 7100000070

Details

Acrylic Adhesive
Fluid resistant
Conformable
Adheres to High Surface Energy Substrates

Typical properties

Adhesive Material: Acrylate
Adhesive Type: Acrylic/Acrylate
Backing Caliper: 32 mil
Backing Caliper (Metric): 810 Micron
Backing Material: PVC Foam
Backing Thickness (Imperial): 32 mil
Backing Thickness (Metric): 810 Micron
Brands: 3M™
Breathable: Yes
Catalog Number: 9777L
Conformability: High
Factory ISO Certification: No ISO Certification information available
Fluid Resistance Backing/Carrier: Yes
Hypoallergenic: No
Liner Caliper (Metric): 100 Micron
Liner Caliper (mils): 4 mil
Liner Color: White
Liner Material: Paper
Liner Weight: 65.0 lb.
Liner Weight (Metric): 106 g/m²
Material: PVC Foam
Maximum Length (Metric): 133 m
Maximum Width Capacity: 48 in
Maximum Width Capacity (Metric): 1220 mm
Printable Backing: Yes
Product Color: Ivory
Product Type: Medical Tape
Product Usage: Adhesion to Skin
Sterilization Method: Ethylene Oxide (EO), Gamma
Tape Total Caliper: 34.0 mil
Tape Total Caliper (Metric): 860.0 Micron
Tape Type: Single Sided Foam Tape
eClass 14 Classification Group: 34390202

Dimensions and Classifications

Overall Thickness (Imperial): 0.55 in
Overall Thickness (Metric): 0.9 mm

3M™ Bair Hugger™ Warming Blanket, 45534 NOVAPLUS Pediatric Underbody, 10/Case

3M ID 7100087638 UPC 50707387775204

Details

Single-use forced-air warming blanket with excellent heat transfer
Consists of a soft, comfortable material
Helps maintain normothermia, which can reduce the rate of complications,
including surgical site infection (SSI) (1,2)
To provide safe, effective

Typical properties

Application: Medical
Blanket Type: Underbody
Brands: Bair Hugger™
Factory ISO Certification: No ISO Certification information available
Product Type: Blanket
Total Units per Case: 10 per Case
eClass 14 Classification Group: 34540392

INFOV.A.C.™ Canister without Gel, M8275071/5, 5/pk

3M ID 7100236776 UPC 00849554002081

Details

Sterile 3M™ V.A.C.® Canister without Gel for 3M™ V.A.C.® Ulta and V.A.C.®
RX4 Therapy Systems
3M™ V.A.C.® Canisters feature 3M™ SensaT.R.A.C.™ Tubing
Two sizes available: 500 mL and 1,000 mL
Available in cases of 5 and 10
Package Contents: 1 canister

Typical properties

Brands: V.A.C.®
Factory ISO Certification: No ISO Certification information available
Volume (Metric): 500 mL
eClass 14 Classification Group: 34210701

3M™ Microfluidic Diagnostic Tape, 9981, Silicone Adhesive on Bright Aluminum Foil Tape, 11 in, 2 mil, Configurable

3M ID 7100271523

Details

- Thermally conductive high reflective foil backing
- High bonding to most substrates
- Bioassay compatible adhesive, non-clouding when exposed to moisture
- Chemically inert
- Low fluorescing

Typical properties

- Brands: 3M™
- Factory ISO Certification: No ISO Certification information available
- eClass 14 Classification Group: 34180101

3M™ Littmann® Stethoscope Spare Parts Kit Classic II Pediatric Diaphragm Assembly, 40012, 10 Kit/Case

3M ID 7100060435 UPC 00707387772994

Details

Dual-sided chestpiece with small 3.3cm diaphragm is ideal for pediatric patients
Contains one floating diaphragm for the stethoscope chestpiece
Contains a black rim for assembly of the diaphragm to the chestpiece
Contains a Gray rim for assembly of the

Typical properties

Brands: Littmann®
Cladimed Code: K50BE02
Diaphragm Diameter (Imperial): 1.3 in
Diaphragm Diameter (Metric): 3.3 cm
Factory ISO Certification: No ISO Certification information available
Kit Includes: Black Snap-on Rim, Floating Diaphragm, Grey Snap-on Rim
Model: Pediatric
Product Color: Black, Gray
Product Type: Spare Parts Kit
Units per Pack: 10
eClass 14 Classification Group: 34340191

3M™ Surgical Clipper Professional, 9681, 1/CV

3M ID 7100213188 UPC 00707387790530

Details

3M™ Surgical Clipper Professional Blade 9680 blade helps prevent skin from being pulled into the cutting blade
Single blade for standard and trauma procedures
Removes all types of hair in a single pass
120 minutes of use time on a minimal 4-hour rechar

Typical properties

Brands: 3M™
Cladimed Code: Non applicable
Factory ISO Certification: No ISO Certification information available
Head Type: Fixed
Inner Packs per Case: 4 Cartons per Case
Model: 9681
Product Type: Clipper
Therapeutic Area and Conditions: Pre-Operative Hair Removal
Total Units per Case: 4 per Case
Units per Inner Pack: 1 per Carton
Units per Pack: 1
eClass 14 Classification Group: 47040590

Dimensions and Classifications

Overall Length (Metric): 6 cm
Overall Width (Metric): 18 cm

3M™ Scotch Series 1100 Electrosurgical Patient Pad II, 1182, Split Non-Corded, 1 Each/Pack, 100 Packs/Case

3M ID 7100239282 UPC 50707387804959

Details

White foam backing
For use with a 3M 21174 reusable cable

Typical properties

Brands: 3M™
Department: OR
Factory ISO Certification: No ISO Certification information available
Product Type: Diathermy Plate
Units per Pack: 1
eClass 14 Classification Group: 34580113

Dimensions and Classifications

Overall Length (Metric): 10.1 cm
Overall Width (Metric): 14.7 cm

3M™ CoTran™ Pigmented Polyethylene Monolayer Backing Film, 9718, Configurable

3M ID 7100065959

Details

Tan
Breathable
Printable
Corona treated on both sides
Matte finish on both sides
Can be directly laminated to adhesives
Heat Sealable (PE)

Typical properties

Backing (Carrier) Material: Polyethylene
Brands: CoTran™
Breathability: Breathable
Caliper: 3.6 mils
Caliper (Metric): 91.4 µm
Catalog Number: 9718
Elongation CD: 400%
Elongation MD: 180%
Factory ISO Certification: No ISO Certification information available
Heat Seal Layer: Polyethylene (PE)
MVTR (g/m²/24 hr): 4
Oxygen Transmission (cc/m²/24hr): 3900
Product Color: Tan
Product Type: Transdermal Backing
Sample Roll: 6 in x 25 yds
Sample Roll (Metric): 15 cm x 23 m
Tensile CD: 5.1 lbs/in
Tensile CD (Metric): 2270 g/25 mm
Tensile MD: 6.8 lbs/in
Tensile MD (Metric): 30.3 N/25.4 mm
eClass 14 Classification Group: 41011103

Dimensions and Classifications

Overall Length (Imperial): 1250 yd
Overall Length (Metric): 1143 m
Overall Thickness (Imperial): 3.6 mil
Overall Thickness (Metric): 91.4 micron
Overall Width (Imperial): 48.031 in
Overall Width (Metric): 122 cm

3M™ Medical Tape 1527ENP, Single Sided Transparent EVA Embossed, 63# Liner, Configurable

3M ID 7100082765

Details

Tackified Acrylic Adhesive
Fluid Resistant
Textured
Good Processability
Diecuttable for converting

Typical properties

Adhesive Material: Acrylate
Adhesive Type: Acrylic/Acrylate (Tack)
Backing Caliper: 4.8 mil
Backing Caliper (Metric): 120 Micron
Backing Material: Polyolefin
Backing Thickness (Imperial): 4.8 mil
Backing Thickness (Metric): 120 Micron
Brands: 3M™
Breathable: Yes
Conformability: Medium
Factory ISO Certification: No ISO Certification information available
Fluid Resistance Backing/Carrier: Yes
Hypoallergenic: No
Latex: No
Liner Caliper (Metric): 120 Micron
Liner Caliper (mils): 4.9 mil
Liner Color: White
Liner Material: Paper
Liner Weight: 63.0 lb.
Liner Weight (Metric): 103 g/m²
Material: Polyolefin
Maximum Length (Metric): 320 m
Maximum Width Capacity: 48 in
Maximum Width Capacity (Metric): 1220 mm
Printable Backing: No
Product Color: Transparent
Product Type: Polyethylene
Product Usage: Adhesion to Skin, Adhesion to Substrate
Sterilization Method: Ethylene Oxide (EO), Gamma
Tape Color: Transparent
Tape Total Caliper: 7.4 mil
Tape Total Caliper (Metric): 190.0 Micron
Tape Type: Single-sided Polyolefin Tape
eClass 14 Classification Group: 34180101

Dimensions and Classifications

Overall Thickness (Imperial): 1 in
Overall Thickness (Metric): 0.19 mm
Overall Width (Imperial): 48 in
Overall Width (Metric): 121.92 cm

3M™ Medical Tape 9865A, Single Sided Polyethylene, 42# Liner, Configurable

3M ID 7100092058

Details

Acrylic Adhesive
Fluid Resistant
Printable
Good Processability

Typical properties

Adhesive Material: Acrylate
Adhesive Type: Acrylic/Acrylate
Backing Caliper: 3 mil
Backing Caliper (Metric): 80 Micron
Backing Material: Polyethylene
Backing Thickness (Imperial): 3 mil
Backing Thickness (Metric): 80 Micron
Brands: 3M™
Breathable: No
Conformability: High
Factory ISO Certification: No ISO Certification information available
Fluid Resistance Backing/Carrier: Yes
Hypoallergenic: No
Latex: No
Liner Caliper (Metric): 60 Micron
Liner Caliper (mils): 3.2 mil
Liner Color: White
Liner Material: Paper
Liner Weight: 54.0 lb.
Liner Weight (Metric): 88 g/m²
Material: Polyethylene
Maximum Length (Metric): 1143 m
Maximum Width Capacity: 48 in
Maximum Width Capacity (Metric): 1220 mm
Printable Backing: Yes
Product Color: Transparent
Product Type: Polyethylene
Product Usage: Adhesion to Skin, Adhesion to Substrate
Sterilization Method: Ethylene Oxide (EO), Gamma
Tape Color: Transparent
Tape Total Caliper (Metric): 100.0 Micron
Tape Type: Single-sided Polyethylene Tape
eClass 14 Classification Group: 34180101

Dimensions and Classifications

Overall Thickness (Imperial): 1 in
Overall Thickness (Metric): 0.1 mm

Overall Width (Imperial): 48 in
Overall Width (Metric): 121.92 cm

3M™ Medical Tape 1587, Double Sided Differential Adhesive Polyester, 60# Liner, Configurable

3M ID 7100013655

Details

Synthetic Rubber Adhesive / Acrylic Adhesive
Fluid Resistant
Good Processability
Medium weight liner

Typical properties

Backing Caliper: 0.5 mil
Backing Caliper (Metric): 10 Micron
Backing Material: Polyester
Backing Thickness (Imperial): 0.5 mil
Backing Thickness (Metric): 10 Micron
Brands: 3M™
Breathable: No
Conformability: Medium
Factory ISO Certification: No ISO Certification information available
Fluid Resistance Backing/Carrier: Yes
Liner Caliper (Metric): 90 Micron
Liner Caliper (mils): 3.5 mil
Liner Color: White
Liner Material: Paper
Liner Weight: 62.0 lb.
Liner Weight (Metric): 98 g/m²
Material: Polyester
Maximum Length (Metric): 640 m
Maximum Width Capacity: 48 in
Maximum Width Capacity (Metric): 1220 mm
Printable Backing: No
Product Color: Transparent
Product Type: Double Sided Tape
Product Usage: Adhesion to Skin, Adhesion to Substrate
Sterilization Method: Ethylene Oxide (EO), Gamma
Tape Color: Transparent
Tape Total Caliper: 3.4 mil
Tape Total Caliper (Metric): 80.0 Micron
Tape Type: Double-sided Polyester Tape
eClass 14 Classification Group: 34180101

Dimensions and Classifications

Overall Thickness (Imperial): 6.3 mil
Overall Thickness (Metric): 0.08 micron
Overall Width (Imperial): 48 in
Overall Width (Metric): 1219.2 mm

3M™ Single-Patient Stethoscope, 100/cs, SPS-YA1100

Part Number SPS-YA1100 3M ID 7100137930 UPC 50707387784206

Details

High-quality acoustics provide clear and reliable sound for patient assessments
Soft eartips seal out distracting noise and make listening easier
Comfortable headset with angled ear tubes and soft eartips provide an excellent acoustic seal
Easy-grip ch

Typical properties

Brands: 3M™
Catalog Number: SPS-YA1100
Chestpiece Color: Gray
Diaphragm Diameter (Imperial): 1.78 in
Diaphragm Diameter (Metric): 4.52 cm
Diaphragm Material: Epoxy/Fiberglass
Diaphragm Type: Pressure-sensitive
Eartip Type: Soft Sealing
Factory ISO Certification: No ISO Certification information available
Headset Finish: Gray
Headset Material: Polypropylene
Patient: Adult
eClass 14 Classification Group: 34340191

Dimensions and Classifications

Overall Length (Imperial): 28.5 in
Overall Length (Metric): 72.4 cm

3M™ Curoc™ Disinfecting Cap for Tego® Hemodialysis Connectors CTG1-270

3M ID 7100085564 UPC 50707387773811

Details

Disinfects in 1 minute and provides a physical barrier to contamination between accesses for up to 7 days if not removed

Twists on easily and stays securely in place

Compatible* with Tego® Hemodialysis Connector. *ICU Medical. "Tego Swab Recommendations

Typical properties

Brands: Curoc™

Catalog Number: CTG1-270

Compatible Connector: Hemodialysis Connectors

Condition: I.V. Related

Factory ISO Certification: No ISO Certification information available

Latex: No

Package Contents: Individuals

Product Type: Disinfecting Cap

Shelf Life: 3 Year

eClass 14 Classification Group: 34221209

3M™ Medical Tape 4076, Polyester Spunlace Nonwoven Extended Wear, 83# Liner, CONFIGURABLE

3M Product Number 4076 3M ID 7100145200

Details

Extended Weartime Acrylic Adhesive
Breathable
Conformable
Good Processability
Moderate stretch

Typical properties

Adhesive Type: Acrylic
Backing (Carrier) Material: Polyester Spunlace
Brands: 3M™
Breathable: Yes
Conformability: High
Factory ISO Certification: No ISO Certification information available
Liner Material: Paper
Printable Backing: Yes
Product Usage: Adhesion to Substrate
Tape Type: Single Sided Spunlace Nonwoven Tape
eClass 14 Classification Group: 34180201

Dimensions and Classifications

Overall Width (Imperial): 48 in
Overall Width (Metric): 121.92 cm

3M™ Coban™ 2 Lite Two-Layer Compression System with Stocking 2794N, 1 Kit/Carton 8 Carton/Case

3M ID 7100069004 UPC 50707387773743

Details

Comfortable – Provides sustained therapeutic compression for up to 7 days
Stays in place – Clinically proven to significantly reduce slippage, to encourage longer wear
Provides consistent compression – The compression layer is designed to be applied at

Typical properties

Boxes per Case: 8.0
Brands: Coban™
Catalog Number: 2794N
Comfort Layer Length (Imperial): 2.9 yd
Comfort Layer Length (Metric): 2.7 m
Comfort Layer Width (Imperial): 4 in
Comfort Layer Width (Metric): 10 cm
Compression Level: Lite
Condition: Wound Care
Department: Wound Care
Factory ISO Certification: No ISO Certification information available
Features: With Stocking
Hypoallergenic: Yes
Inner Packs per Case: 8 Cartons per Case
Latex: No
Product Type: Compression Wrap
Units per Inner Pack: 1 per Carton
Units per Pack: 1
Wound Care Condition Type: Venous Leg Ulcer
eClass 14 Classification Group: 34190302

Dimensions and Classifications

Compression Layer Length (Imperial): 5.1 yd
Compression Layer Length (Metric): 4.7 m
Compression Layer Width (Imperial): 4 in
Compression Layer Width (Metric): 10 cm

3M™ Electrosurgical Reusable Cable 21174L

3M ID 7000128567 UPC 00707387468101

Details

Electrosurgical Cable

Typical properties

Brands: 3M™

Clinical Area: Critical Care, Emergency Medical Services (EMS), Emergency Room, Intensive Care, Pediatric, Physician Office, Surgery

Clinical Sub-Area: Orthopedics

Disposable: No

Factory ISO Certification: No ISO Certification information available

Product Type: Cable

eClass 14 Classification Group: 34580113

Dimensions and Classifications

Overall Length (Imperial): 15 ft

Overall Length (Metric): 4.5 m

3M™ Medical Transfer Adhesive 4075, Extended Wear, Poly Liner, CONFIGURABLE

3M Product Number 4075 3M ID 7100167252

Details

Extended Weartime Acrylic Adhesive
Combine with the backing of your choice
Can be used as a construction adhesive
Good Processability

Typical properties

Backing Caliper: 2.8 mil
Backing Caliper (Metric): 71 Micron
Brands: 3M™
Breathable: Yes
Conformability: High
Factory ISO Certification: No ISO Certification information available
Liner Material: Polyester
Product Type: Adhesive Transfer Tape
Product Usage: Adhesion to Skin, Adhesion to Substrate
eClass 14 Classification Group: 15360503

3M™ Surgical Clipper Professional Blade, 9680, 50 EA/Case

3M ID 7100213055 UPC 50707387789454

Details

3M™ Surgical Clipper Professional Blade 9680 blade helps prevent skin from being pulled into the cutting blade

Single blade for standard and trauma procedures

Removes all types of hair in a single pass

LED indicator lights provide battery charge status

Typical properties

Brands: 3M™

Cladimed Code: F52AB01

Factory ISO Certification: No ISO Certification information available

Head Type: Fixed

Model: 9680

Product Type: Clipper

Therapeutic Area and Conditions: Pre-Operative Hair Removal

Units per Pack: 50

eClass 14 Classification Group: 47040590

**3M™ Avagard™ Instant Hand Antiseptic Wall Bracket, 9236, (White),
16
Each/Case**

3M ID 7000053936 UPC 50707387584677

Details

Innovative design allows fast and easy installation and use of existing 500 mL pump bottles
Promotes patient safety by putting an effective hand hygiene product anywhere needed

Typical properties

Accessory Type: Bracket
Brands: Avagard™
Dispensing System: Hand Pump
Factory ISO Certification: No ISO Certification information available
Model: 9236
Product Type: Dispenser, Bracket & Accessory
Product Use: Accessory
eClass 14 Classification Group: 20420207

3M™ Cavilon™ No-Rinse Skin Cleanser 3380

3M ID 7000009914 UPC 50707387446968

Details

Gentle, effective pH-balanced no-rinse skin cleanser soothes skin and cleans without irritation

Contains moisturizing and conditioning ingredients for use on intact and irritated skin while providing a clean feel

Eliminates need for rinsing for more con

Typical properties

Brands: Cavilon™

Clinical Area: Cardiovascular, Intensive Care, Oncology, Palliative Care, Pediatric, Wound Care

Clinical Sub-Area: Obstetrics and Gynaecology, Orthopedics

Condition: Pressure Ulcer, Skin Care

Department: Cardiovascular, Critical Care, Dialysis Center, EMERGENCY, I.V. Therapy, Intensive Care Unit, Labor & Delivery, Medical-Surgical, Oncology, Operating Room-Surgery, Orthopedics, Pediatrics, Radiology, Urgent Care, Wound Care

Factory ISO Certification: No ISO Certification information available

Hypoallergenic: Yes

Latex: No

Product Type: Skin Care

Volume (Imperial): 8 fl oz

Volume (Metric): 236 mL

Wound Care Condition Type: Venous Leg Ulcer

eClass 14 Classification Group: 30300401

3M™ Bair Hugger™ 700 Series Warming Unit Rolling Cart Handle, 90094, 1 Each

3M ID 7100242338 UPC 10707387806634

Details

For use with Bair Hugger model 775 warming unit

Typical properties

Brands: Bair Hugger™

Cladimed Code: Non applicable

Clinical Area: OR, PACU, Pre-op

Factory ISO Certification: No ISO Certification information available

Model: 90094

Product Type: Accessory

Quantity: 1 each

Units per Pack: 1

Dimensions and Classifications

Overall Length (Imperial): 5 in

Overall Length (Metric): 2.5 cm

Overall Width (Imperial): 1 in

Overall Width (Metric): 24.1 cm

3M™ Ranger™ Fluid Warming Irrigation Set, 24750, 10/Case

3M ID 7100235070 UPC 10707387792722

Details

Not made with natural rubber latex; Not made with DEHP

Flow rates from KVO - 865 mL/min

Priming volume 308 mL

Patient line is contained within its own sterile packaging for use within the sterile field

Typical properties

Brands: Ranger™

Clinical Area: OR

Contents: Heat exchanger, double spike set, patient line with scope attachment (patient line is contained within its own sterile packaging for use within the sterile field)

Factory ISO Certification: No ISO Certification information available

Fluid Type: Irrigation Fluid

Model: 24750

Pressure Infusion: Up to 300 mmHg maximum dynamic operating pressure

Priming Volume: 308 mL

Product Type: Disposable Set

Quantity: 10 Case

Set Type: Irrigation

Sterile: Ethylene Oxide (EO)

eClass 14 Classification Group: 34540392

3M™ Medical Tape 9877EL, Double Coated Transparent Polyester, 80# Liner, Configurable

3M ID 7100127436

Details

Synthetic Rubber Adhesive
Fluid Resistant
Good Processability

Typical properties

Brands: 3M™
Factory ISO Certification: No ISO Certification information available
Hypoallergenic: No
Latex: No
eClass 14 Classification Group: 34180101

Dimensions and Classifications

Overall Width (Imperial): 48 in
Overall Width (Metric): 121.92 cm

3M™ Medical Tape 1567, Double Sided Polyester, 60# Liner, Configurable

3M Product Number 1567 3M ID 7100287656

Details

Synthetic Rubber Adhesive
Fluid Resistant
Good Processability

Typical properties

Brands: 3M™
Product Type: Medical Tape
Tape Type: Double-sided Polyester Tape
eClass 14 Classification Group: 34180101

3M™ Steri-Drape™ Medium Drape with Aperture, 1030, 130 cm x 80 cm (51 in x 31 in), 10/Case, 4 Cases/Case

3M Product Number 1030 3M ID 7000053456 UPC 30707387018765

Details

Impervious polyethylene film provides a barrier to liquids, reducing exposure to blood and body fluids

Adhesive film isolates the surgical site from lid margins, eyelashes and eyebrows to help reduce the risk of surgical site contamination

Matte finish

Typical properties

Accessories: Aperture

Brands: Steri-Drape™

Cladimed Code: E51BA99

Factory ISO Certification: No ISO Certification information available

Incise Area Width (Metric): 25 cm

Loophole Length (Metric): 5.1 cm

Loophole Width (Metric): 7.4 cm

Material: Plastic

Model: 1030

Procedure: EENT

Product Color: Transparent

Product Type: Aperture Drape

Product Type Free Format: Drape

Product Use: EENT

Sterile: Yes

Therapeutic Area and Conditions: Ophthalmic

Units per Pack: 10

Dimensions and Classifications

Overall Length (Imperial): 51 in

Overall Length (Metric): 130 cm

Overall Width (Imperial): 31 in

Overall Width (Metric): 80 cm

3M™ Steri-Drape™ 2 Incise Drape, 2051, Incise Area 60 cm x 85 cm (23 1/2 in x 33 3/8 in), 10/Carton, 4 Cartons/Case

3M ID 7100238517 UPC 50707387793086

Details

Drape creates a sterile surface at the beginning of surgery
Drape adhesive adheres securely to skin and immobilizes bacteria
Plastic film provides a barrier to liquids
Breathable film is conformable for easy application, even around difficult anatomica

Typical properties

Accessories: Miscellaneous
Brands: Steri-Drape™
Clinical Area: Surgery
Clinical Sub-Area: Obstetrics and Gynaecology, Orthopedics
Factory ISO Certification: No ISO Certification information available
Features: Clear
Model: 2051
Procedure: General Surgery
Product Type: Incise Drapes
Product Type Free Format: Incise Drapes
Product Use: Incise
Sterile: Yes
Units per Pack: 10

Dimensions and Classifications

Overall Length (Imperial): 23.5 in
Overall Length (Metric): 60 cm
Overall Width (Imperial): 33.375 in
Overall Width (Metric): 85 cm

3M™ Steri-Drape™ 2 Incise Drape, 2045, Incise Area 50 cm x 45 cm (19 5/8 in x 17 5/8 in), 10/Carton, 4 Cartons/Case

3M Product Number 2045 3M ID 7100238519 UPC 50707387793062

Details

Drape creates a sterile surface at the beginning of surgery
Drape adhesive adheres securely to skin and immobilizes bacteria
Plastic film provides a barrier to liquids
Breathable film is conformable for easy application, even around difficult anatomica

Typical properties

Accessories: Miscellaneous
Brands: Steri-Drape™
Clinical Area: Surgery
Clinical Sub-Area: Obstetrics and Gynaecology, Orthopedics
Factory ISO Certification: No ISO Certification information available
Features: Clear
Model: 2045
Procedure: General Surgery
Product Type: Incise Drapes
Product Type Free Format: Incise Drapes
Product Use: Incise
Sterile: Yes
Units per Pack: 10

Dimensions and Classifications

Overall Length (Imperial): 19.625 in
Overall Length (Metric): 50 cm
Overall Width (Imperial): 17.625 in
Overall Width (Metric): 45 cm

3M™ Steri-Drape™ Cardiovascular Sheet with Ioban™ 2 Incise Film, 2045NS, 60 cm x 45 cm, 200/Case

3M ID 7000053490 UPC 00707387098582

Details

Drape creates a sterile surface at the beginning of surgery
Drape adhesive adheres securely to skin and immobilizes bacteria
Plastic film provides a barrier to liquids
Breathable film is conformable for easy application, even around difficult anatomica

Typical properties

Brands: Steri-Drape™
Cladimed Code: E51BA99
Factory ISO Certification: No ISO Certification information available
Product Type: Incise Drapes
Product Use: Incise

Dimensions and Classifications

Overall Length (Metric): 45 cm
Overall Width (Metric): 50 cm

3M™ Steri-Drape™ Cardiovascular Sheet with Ioban™ 2 Incise Film, 2040NS, 38 cm x 41cm, 200/Case

3M ID 7000053489 UPC 00707387098575

Details

Drape creates a sterile surface at the beginning of surgery
Drape adhesive adheres securely to skin and immobilizes bacteria
Plastic film provides a barrier to liquids
Breathable film is conformable for easy application, even around difficult anatomica

Typical properties

Brands: Steri-Drape™
Cladimed Code: E51BA99
Factory ISO Certification: No ISO Certification information available
Product Type: Incise Drapes
Product Use: Incise

Dimensions and Classifications

Overall Length (Metric): 41 cm
Overall Width (Metric): 28 cm

3M™ Medical Release Liner 1360, Silicone, 63 # Paper, 49.5 IN x 7,000 YD

3M ID 7100116033 UPC 00707387559434

Details

Easy release

Printable

General Device Use

Material and / or technology for health care or medical device construction

Typical properties

Brands: 3M™

Factory ISO Certification: No ISO Certification information available

eClass 14 Classification Group: 15360503

Dimensions and Classifications

Overall Length (Imperial): 7000 yd

Overall Length (Metric): 6400.8 m

Overall Width (Imperial): 49.5 in

Overall Width (Metric): 125.73 cm

3M™ Medical Tape 9904, Single Sided High Tack Elastic Nonwoven Fabric, 60# Liner, Configurable

3M ID 7100045884

Details

Tackified Acrylic Adhesive
Printable
Conformable
Good Processability

Typical properties

Adhesive Material: Acrylate
Adhesive Type: Acrylic/Acrylate (Tack)
Backing (Carrier) Material: Polyurethane
Brands: 3M™
Breathable: Yes
Conformability: High
Factory ISO Certification: No ISO Certification information available
Fluid Resistance Backing/Carrier: No
Hypoallergenic: No
Latex: No
Liner Caliper (Metric): 90 Micron
Liner Caliper (mils): 3.5 mil
Liner Color: White
Liner Material: Paper
Liner Weight: 60.0 lb.
Liner Weight (Metric): 98 g/m²
Material: Polyurethane
Maximum Length (Metric): 229 m
Maximum Width Capacity: 50 in
Maximum Width Capacity (Metric): 1270 mm
Printable Backing: Yes
Product Color: Tan
Product Type: Non-woven Polyurethane Tape
Product Usage: Adhesion to Skin, Adhesion to Substrate
Sterilization Method: Ethylene Oxide (EO), Gamma
Tape Color: Tan
Tape Total Caliper: 11.0 mil
Tape Total Caliper (Metric): 280.0 Micron
Tape Type: Single Sided Elastic Nonwoven Fabric Tape
eClass 14 Classification Group: 34180201

Dimensions and Classifications

Overall Thickness (Imperial): 1 in
Overall Thickness (Metric): 0.28 mm
Overall Width (Imperial): 50 in
Overall Width (Metric): 127 cm

3M™ Medical Tape 1525L, Single Sided Transparent Polyethylene, 63# Liner, Configurable

3M ID 7100001452

Details

Acrylic Adhesive
Fluid Resistant
Printable with treatment
Good Processability

Typical properties

Adhesive Material: Acrylate
Adhesive Type: Acrylic/Acrylate
Backing Caliper: 3 mil
Backing Caliper (Metric): 80 Micron
Backing Material: Polyethylene
Backing Thickness (Imperial): 3 mil
Backing Thickness (Metric): 80 Micron
Brands: 3M™
Breathable: No
Conformability: High
Factory ISO Certification: No ISO Certification information available
Fluid Resistance Backing/Carrier: Yes
Hypoallergenic: No
Latex: No
Liner Caliper (Metric): 120 Micron
Liner Caliper (mils): 4.9 mil
Liner Color: White
Liner Material: Paper
Liner Weight: 63.0 lb.
Liner Weight (Metric): 103 g/m²
Material: Polyethylene
Maximum Length (Metric): 457 m
Maximum Width Capacity: 48 in
Maximum Width Capacity (Metric): 1220 mm
Printable Backing: Yes
Product Color: Transparent
Product Type: Polyethylene
Product Usage: Adhesion to Skin, Adhesion to Substrate
Sterilization Method: Ethylene Oxide (EO), Gamma
Tape Color: Transparent
Tape Total Caliper: 4.4 mil
Tape Total Caliper (Metric): 110.0 Micron
Tape Type: Single-sided Polyethylene Tape
eClass 14 Classification Group: 34180101

Dimensions and Classifications

Overall Thickness (Imperial): 1.875 in

Overall Thickness (Metric): 0.11 mm
Overall Width (Imperial): 48 in
Overall Width (Metric): 121.92 cm

3M™ Medical Tape 1776, Single Sided Polyester Spunlace Nonwoven Fabric, 83# Liner, Configurable

3M ID 7100013450

Details

Acrylic Adhesive
Breathable
Conformable
Good Processability

Typical properties

Adhesive Material: Acrylate
Adhesive Type: Acrylic/Acrylate
Backing (Carrier) Material: Polyester Spunlace
Brands: 3M™
Breathable: Yes
Conformability: High
Factory ISO Certification: No ISO Certification information available
Fluid Resistance Backing/Carrier: No
Hypoallergenic: No
Liner Caliper (Metric): 150 Micron
Liner Caliper (mils): 6 mil
Liner Color: White
Liner Material: Paper
Liner Weight: 83.0 lb.
Liner Weight (Metric): 135 g/m²
Material: Spunlace Non-woven
Maximum Length (Metric): 366 m
Maximum Width Capacity: 48 in
Maximum Width Capacity (Metric): 1220 mm
Printable Backing: Yes
Product Color: White
Product Type: Non-woven Polyester & Polyester Blend Tape
Product Usage: Adhesion to Substrate
Sterilization Method: Ethylene Oxide (EO), Gamma
Tape Color: White
Tape Total Caliper: 11.5 mil
Tape Total Caliper (Metric): 290.0 Micron
Tape Type: Single Sided Spunlace Nonwoven Tape
eClass 14 Classification Group: 34180201

Dimensions and Classifications

Overall Thickness (Imperial): 5.5 mil
Overall Thickness (Metric): 0.3 mm
Overall Width (Imperial): 48 in
Overall Width (Metric): 121.92 cm

3M™ Medical Tape 9833, Single Sided Polyurethane, 78# Carrier, Configurable

3M ID 7100000231

Details

Acrylic Adhesive
Breathable
Fluid Resistant
Conformable

Typical properties

Adhesive Material: Acrylate
Adhesive Type: Acrylic/Acrylate
Backing Caliper: 1.1 mil
Backing Caliper (Metric): 30 Micron
Backing Material: Polyurethane
Backing Thickness (Imperial): 1.1 mil
Backing Thickness (Metric): 30 Micron
Brands: 3M™
Breathable: Yes
Conformability: Very High
Factory ISO Certification: No ISO Certification information available
Fluid Resistance Backing/Carrier: Yes
Hypoallergenic: No
Latex: No
Liner Caliper (Metric): 130 Micron
Liner Caliper (mils): 5 mil
Liner Color: White
Liner Material: Paper
Liner Weight: 78.0 lb.
Liner Weight (Metric): 127 g/m²
Material: Polyurethane
Maximum Length (Metric): 640 m
Maximum Width Capacity: 46 in
Maximum Width Capacity (Metric): 1170 mm
Printable Backing: Yes
Product Color: Transparent
Product Type: Polyester, Incise & Polyurethane
Product Usage: Adhesion to Skin
Sterilization Method: Ethylene Oxide (EO), Gamma
Tape Color: Transparent
Tape Total Caliper: 2.0 mil
Tape Total Caliper (Metric): 50.0 Micron
Tape Type: Single-sided Polyurethane Tape
eClass 14 Classification Group: 34180101

Dimensions and Classifications

Overall Thickness (Imperial): 0.43 in

Overall Thickness (Metric): 0.05 mm
Overall Width (Imperial): 46 in
Overall Width (Metric): 117 cm

3M™ Steri-Strip™ Compound Benzoin Tincture C1544, 2/3 cc vial, 40 Packs/ Carton, 4 Cartons/Case

3M ID 7100239556 UPC 10707387792814

Details

Increased adhesion- The Compound Benzoin Tincture may be used to increase Steri-Strip Skin Closure adhesion

Aseptic delivery- Sterile tray packaging allows aseptic delivery

Typical properties

Brands: Steri-Strip™

Department: Critical Care, EMERGENCY, Intensive Care Unit, Labor & Delivery, Medical-Surgical, Operating Room-Surgery, Orthopedics, Pediatrics, Urgent Care, Wound Care

Factory ISO Certification: No ISO Certification information available

Hypoallergenic: No

Latex: No

Product Color: Transparent

Product Type: Skin Closures

Sterile: Yes

Therapeutic Area and Conditions: Adhesive

Units per Pack: 40

eClass 14 Classification Group: 34180306

3M™ Medical Loop Fastener 7331, Low Profile with Adhesive, Configurable

3M ID 7100070639

Details

Available with Synthetic Rubber Adhesive or No Adhesive
Easy to open yet high shear strength during use
Low Profile
Intended for disposable/short term uses

Typical properties

Adhesive Type: Synthetic Rubber
Brands: 3M™
Factory ISO Certification: No ISO Certification information available
Product Color: White

3M™ Double Stick Discs, 102 each/pack, 6 pack/case, 2181

3M ID 7000053508 UPC 50707387234800

Details

Discs are tabbed for easy handling and removal
Excellent adhesion for secure attachment to the skin, reducing need to replace or readjust disc
Hypoallergenic adhesive reduces the risk of allergic reaction
Conveniently packaged three discs per liner she

Typical properties

Brands: Littmann®
Factory ISO Certification: No ISO Certification information available
Hypoallergenic: Yes
Model: All Stethoscopes
eClass 14 Classification Group: 34340191

3M™ Ranger™ Pressure Infusor, 14500, Model 145, 120V-ENG-B, 1 Each

3M ID 7100236176 UPC 00707387802943

Details

Flexibly accommodates a large range of fluid bag sizes, from 250 mL to 1000 mL
Pressure infusor chambers function independently allowing clinicians to focus on patients
Built in audio and visual indicators should bladder pressure exceed 330 mmHg or fall

Typical properties

Brands: Ranger™
Clinical Area: ER, ICU, L&D, OR
Factory ISO Certification: No ISO Certification information available
Fluid Type: Blood/Fluid
Model: 14500
Pressure Infusion: Up to 300 mmHg maximum dynamic operating pressure
Product Type: Pressure Infusor
Quantity: 1 each

Dimensions and Classifications

Overall Height (Imperial): 7.75 in
Overall Height (Metric): 40 cm
Overall Length (Imperial): 15.75 in
Overall Length (Metric): 40 cm
Overall Width (Imperial): 20 in
Overall Width (Metric): 51 cm

3M™ Avagard™ Drip Tray Accessory 9243, 12 EA/Case

3M ID 7100032641 UPC 50707387764994

Details

Use with 9240 & 9241 Dispensor

Typical properties

Accessory Type: Drip Tray

Brands: Avagard™

Dispensing System: Hand Pump

Factory ISO Certification: No ISO Certification information available

eClass 14 Classification Group: 20420207

3M™ Medical Tape 9877, Double Sided Transparent Polyester, 60# Liner, Configurable

3M ID 7100000160

Details

Synthetic Rubber Adhesive
Fluid Resistant
Good Processability

Typical properties

Adhesive Type: Synthetic Rubber
Backing Caliper: 0.92 mil
Backing Caliper (Metric): 23 Micron
Backing Material: Polyester
Backing Thickness (Imperial): 0.92 mil
Backing Thickness (Metric): 20 Micron
Brands: 3M™
Breathable: No
Conformability: Low
Factory ISO Certification: No ISO Certification information available
Fluid Resistance Backing/Carrier: Yes
Hypoallergenic: No
Liner Caliper (Metric): 90 Micron
Liner Caliper (mils): 3.5 mil
Liner Color: White
Liner Material: Paper
Liner Weight: 62.0 lb.
Liner Weight (Metric): 103 g/m²
Material: Polyester
Maximum Length (Metric): 640 m
Maximum Width Capacity: 48 in
Maximum Width Capacity (Metric): 1220 mm
Printable Backing: No
Product Color: Transparent
Product Type: Double Sided Tape
Product Usage: Adhesion to Skin, Adhesion to Substrate
Sterilization Method: Ethylene Oxide (EO), Gamma, Steam
Tape Color: Transparent
Tape Total Caliper (Metric): 110.0 Micron
Tape Type: Double-sided Polyester Tape
eClass 14 Classification Group: 34180101

Dimensions and Classifications

Overall Thickness (Imperial): 0.67 in
Overall Thickness (Metric): 0.11 mm
Overall Width (Imperial): 48 in
Overall Width (Metric): 121.92 cm

3M™ Attest™ Ethylene Oxide Biological Indicator, 1264-S, Green Cap, 48 hr, 300/CAR, 2 CAR/CS, 600/CS

3M ID 7000053810 UPC 30707387575152

Details

Accurate results with 48-hour visual color readout
Designed for industrial (Life Science) ethylene oxide (EO, EtO) sterilization applications
Color-coded (green cap) for quick reference and easy use
ISO 11138-1:2017 and ISO 11138-2:2017 compliant
Prot

Typical properties

Biological Indicator System: Standard
Brands: Attest™
Cap Color: Green
Catalog Number: 1264-S
Cladimed Code: E52IC02
Factory ISO Certification: No ISO Certification information available
Incubation Period: 48 Hour
Inner Packs per Case: 2 Cartons per Case
Product Type: Biological Indicator
Sterilization Method: Ethylene Oxide (EO)
Total Units per Case: 600 per Case
Units per Inner Pack: 300 per Carton
eClass 14 Classification Group: 34410601

**3M™ Attest™ Rapid Steam Biological Indicator, 1292-S, Brown Cap, 3
hr,
300/CAR, 2 CAR/CS, 600/CS**

3M ID 7000053809 UPC 30707387575145

Details

Accurate results in 3 hours
Appropriate for use in industrial (Life Science) steam sterilization applications
Color-coded (brown cap) for quick reference and easy use
Compliant with ISO 11138-1:2017 and ISO 11138-3:2017
Protective packaging
Compatibl

Typical properties

Biological Indicator System: Rapid
Brands: Attest™
Cap Color: Brown
Catalog Number: 1292-S
Factory ISO Certification: No ISO Certification information available
Incubation Period: 3 Hour
Inner Packs per Case: 2 Cartons per Case
Product Type: Biological Indicator
Sterilization Method: Steam
Total Units per Case: 600 per Case
Units per Inner Pack: 300 per Carton
eClass 14 Classification Group: 34410601

3M™ Steri-Drape™ Extremity Cover 9041 Non-sterile

3M ID 7000053576 UPC 50707387456226

Details

Resistant to Strikethrough
Reliable, dependable adhesive
Fluid Control Features
Superior Strength and Comfort

Typical properties

Additional Drapes: Sheet
Brands: Steri-Drape™
Cladimed Code: E51CA01
Factory ISO Certification: No ISO Certification information available
Model: 9041
Procedure: Orthopedic
Product Type: Utility Drape
Product Type Free Format: Drape
Product Use: Gynecology
Therapeutic Area and Conditions: Day Surgery, General Surgery, Obstetrics and
Gynaecology, Urology
Units per Pack: 50

Dimensions and Classifications

Overall Length (Imperial): 23.5 in
Overall Length (Metric): 60 cm
Overall Width (Imperial): 13.5 in
Overall Width (Metric): 35 cm

3M™ Prevena Restor™ Adapti-Form™ System Kit, PRE6001, 1 Kit

3M ID 7100284253 UPC 50849554012948

Details

Available in one dressing size (48cm x 29cm) for use to manage incision and the surrounding soft tissue for up to 7-days

The 3M™ Prevena™ Plus 125 Therapy Unit - 14 day provides pre-set, continuous NPWT at -125mmHg up to 14 days with a replaceable 150 mL

Typical properties

Brands: Prevena Restor™

Catalog Number: PRE6001

Factory ISO Certification: No ISO Certification information available

Dimensions and Classifications

Overall Length (Imperial): 11.024 in

Overall Length (Metric): 28 cm

Overall Width (Imperial): 19.291 in

Overall Width (Metric): 49 cm

**3M™ Attest™ Rapid Ethylene Oxide Biological Indicator, 1294-S,
Green
Cap, 4 hr, 300/CAR, 2 CAR/CS, 600/CS**

3M ID 7000053808 UPC 30707387575138

Details

Fast and accurate 4-hour result
Designed for use in industrial (Life Sciences) ethylene oxide (EO, EtO)
sterilization processes
Color-coded (green cap) for quick reference and easy use
ISO 11138-1:2017 and ISO 11138-2:2017 compliant
Protective packaging

Typical properties

Biological Indicator System: Rapid
Brands: Attest™
Cap Color: Green
Catalog Number: 1294-S
Factory ISO Certification: No ISO Certification information available
Incubation Period: 4 Hour
Inner Packs per Case: 2 Cartons per Case
Product Color: Green
Product Type: Biological Indicator
Sterilization Method: Ethylene Oxide (EO)
Total Units per Case: 600 per Case
Units per Inner Pack: 300 per Carton
eClass 14 Classification Group: 34410601

3M™ Microfluidic Diagnostic Tape, 9982R, Silicone Adhesive on Clear PET Tape, 0.98 mil, Configurable

3M ID 7100244307

Details

- Optically clear
- High bonding to most substrates
- Bioassay compatible adhesive, non-clouding when exposed to moisture
- Chemically inert
- Low fluorescing

Typical properties

- Brands: 3M™
- Factory ISO Certification: No ISO Certification information available
- eClass 14 Classification Group: 34180101

3M™ Attest™ Ethylene Oxide Biological Indicator, 1264, Green Cap, 48 hr, 100/PAC, 4 PAC/CS, 400/CS

3M ID 7000002546 UPC 30707387068050

Details

Accurate results with 48-hour visual color readout
ISO 11138-1:2017 and ISO 11138-2:2017 compliant
Color-coded (green cap) for quick reference and easy use
Reliably monitors all ethylene oxide (EO, EtO) sterilization processes
Compatible with 3M™ Atte

Typical properties

Biological Indicator System: Standard
Brands: Attest™
Cap Color: Green
Catalog Number: 1264
Cladimed Code: E52IC02
Factory ISO Certification: No ISO Certification information available
Incubation Period: 48 Hour
Inner Packs per Case: 4 Cartons per Case
Product Color: Green
Product Type: Biological Indicator
Product Type Free Format: Biological Indicators
Product Use: Load Monitoring
Sterilization Method: Ethylene Oxide (EO)
Total Units per Case: 400 per Case
Units per Inner Pack: 100 per Carton
eClass 14 Classification Group: 34410601

3M™ Attest™ Rapid Ethylene Oxide Biological Indicator Test Pack, 1298, Green Cap, 4 hr, 25/CAR, 2 CAR/CS, 50/CS

3M ID 7000002716 UPC 30707387470396

Details

Each test pack contains a 3M™ Attest™ Rapid Ethylene Oxide Biological Indicator, 1294, Green Cap
Comes pre-assembled for convenience and ease of use
Fast and accurate 4-hour result
Presents a challenge to ethylene oxide (EO, EtO) sterilization procedur

Typical properties

Biological Indicator System: Rapid
Brands: Attest™
Cap Color: Green
Catalog Number: 1298
Clinical Area: Medical Device Reprocessing Department
Factory ISO Certification: No ISO Certification information available
Incubation Period: 4 Hour
Inner Packs per Case: 2 Cartons per Case
Product Color: Green
Product Type: Biological Indicator
Product Use: Load Monitoring
Sterilization Method: Ethylene Oxide (EO)
Total Units per Case: 50 per Case
Units per Inner Pack: 25 per Carton
eClass 14 Classification Group: 34410601

3M™ Attest™ Rapid Steam Biological Indicator Test Pack, 1296, Brown Cap, 3 hr, 25/CS

3M ID 7000002696 UPC 50707387236453

Details

Pre-assembled, easy-to-use test pack containing a 3M™ Attest™ Rapid Readout Biological Indicator 1292, Brown Cap, 3 Hour
Accurate BI results in 3 hours when incubated in a 3M™ Attest™ Auto-reader 390
Cost and time-efficient readouts
Test packs present

Typical properties

Biological Indicator System: Rapid
Brands: Attest™
Cap Color: Brown
Catalog Number: 1296
Clinical Area: Medical Device Reprocessing Department
Factory ISO Certification: No ISO Certification information available
Incubation Period: 3 Hour
Product Type: Biological Indicator
Product Use: Load Monitoring
Sterilization Method: Steam
Total Units per Case: 25 per Case
eClass 14 Classification Group: 34410601

3M™ Attest™ Rapid Steam Biological Indicator, 1291, Blue Cap, 1 hr, 50/CAR, 4 CAR/CS, 200/CS

3M ID 7000002621 UPC 30707387140930

Details

Accurate results in 1 hour
Color-coded (blue cap) for quick reference and easy use
Cost and time-efficient biological indicator for 270°F/132°C gravity steam sterilization processes
Compatible with the 3M™ Attest™ Auto-reader 390
Interested in a faste

Typical properties

Biological Indicator System: Rapid
Brands: Attest™
Cap Color: Blue
Catalog Number: 1291
Clinical Area: Medical Device Reprocessing Department
Factory ISO Certification: No ISO Certification information available
Incubation Period: 1 Hour
Inner Packs per Case: 4 Cartons per Case
Product Color: Blue
Product Type: Biological Indicator
Product Type Free Format: Biological Monitoring System
Product Use: Load Monitoring
Sterilization Method: Steam
Total Units per Case: 200 per Case
Units per Inner Pack: 50 per Carton
eClass 14 Classification Group: 34410601

3M™ Attest™ Rapid Steam Biological Indicator, 1292, Brown Cap, 3 hr, 50/CAR, 4 CAR/CS, 200/CS

3M ID 7000002632 UPC 30707387236442

Details

Accurate results in 3 hours
Color-coded (brown cap) for quick reference and easy use
Compliant with ISO 11138-1:2017 and ISO 11138-3:2017
Cost and time-efficient biological indicators for 250°F/121°C gravity displacement and 270°F/132°C vacuum-assisted

Typical properties

Biological Indicator System: Rapid
Brands: Attest™
Cap Color: Brown
Catalog Number: 1292
Factory ISO Certification: No ISO Certification information available
Incubation Period: 3 Hour
Inner Packs per Case: 4 Cartons per Case
Product Color: Brown
Product Type: Biological Indicator
Product Use: Load Monitoring
Sterilization Method: Steam
Total Units per Case: 200 per Case
Units per Inner Pack: 50 per Carton
eClass 14 Classification Group: 34410601

3M™ Scotchpak™ Polyester Backing Film Laminate, 9738, Config Roll

3M ID 7100065993

Details

Tan
Occlusive
Conformable
Controlled caliper

Typical properties

Backing (Carrier) Material: Polyester
Brands: Scotchpak™
Breathability: Occlusive
Caliper: 2.14 mils
Caliper (Metric): 54.4 µm
Catalog Number: 9738
Elongation CD: 50%
Elongation MD: 70%
Factory ISO Certification: No ISO Certification information available
MVTR (g/m²/24 hr): 0.3
Oxygen Transmission (cc/m²/24hr): 2
Product Color: Tan
Product Type: Transdermal Backing
Sample Roll: 6 in x 25 yds
Sample Roll (Metric): 15 cm x 23 m
Tensile CD: 15 lbs/in
Tensile CD (Metric): 66.7 N/25.4 mm
Tensile MD: 12 lbs/in
Tensile MD (Metric): 53.4 N/25.4 mm
eClass 14 Classification Group: 41011103

Dimensions and Classifications

Overall Length (Imperial): 1500 yd
Overall Length (Metric): 1372 m
Overall Width (Imperial): 40 in
Overall Width (Metric): 102 cm

По вопросам продаж и поддержки обращайтесь:

Алматы (7273)495-231
Ангарск (3955)60-70-56
Архангельск (8182)63-90-72
Астрахань (8512)99-46-04
Барнаул (3852)73-04-60
Белгород (4722)40-23-64
Благовещенск (4162)22-76-07
Брянск (4832)59-03-52
Владивосток (423)249-28-31
Владикавказ (8672)28-90-48
Владимир (4922)49-43-18
Волгоград (844)278-03-48
Вологда (8172)26-41-59
Воронеж (473)204-51-73
Екатеринбург (343)384-55-89

Иваново (4932)77-34-06
Ижевск (3412)26-03-58
Иркутск (395)279-98-46
Казань (843)206-01-48
Калининград (4012)72-03-81
Калуга (4842)92-23-67
Кемерово (3842)65-04-62
Киров (8332)68-02-04
Коломна (4966)23-41-49
Кострома (4942)77-07-48
Краснодар (861)203-40-90
Красноярск (391)204-63-61
Курск (4712)77-13-04
Курган (3522)50-90-47
Липецк (4742)52-20-81

Магнитогорск (3519)55-03-13
Москва (495)268-04-70
Мурманск (8152)59-64-93
Набережные Челны (8552)20-53-41
Нижегород (831)429-08-12
Новокузнецк (3843)20-46-81
Ноябрьск (3496)41-32-12
Новосибирск (383)227-86-73
Омск (3812)21-46-40
Орел (4862)44-53-42
Оренбург (3532)37-68-04
Пенза (8412)22-31-16
Петрозаводск (8142)55-98-37
Псков (8112)59-10-37
Пермь (342)205-81-47

Ростов-на-Дону (863)308-18-15
Рязань (4912)46-61-64
Самара (846)206-03-16
Санкт-Петербург (812)309-46-40
Саратов (845)249-38-78
Севастополь (8692)22-31-93
Саранск (8342)22-96-24
Симферополь (3652)67-13-56
Смоленск (4812)29-41-54
Сочи (862)225-72-31
Ставрополь (8652)20-65-13
Сургут (3462)77-98-35
Сыктывкар (8212)25-95-17
Тамбов (4752)50-40-97
Тверь (4822)63-31-35

Тольятти (8482)63-91-07
Томск (3822)98-41-53
Тула (4872)33-79-87
Тюмень (3452)66-21-18
Ульяновск (8422)24-23-59
Улан-Удэ (3012)59-97-51
Уфа (347)229-48-12
Хабаровск (4212)92-98-04
Чебоксары (8352)28-53-07
Челябинск (351)202-03-61
Череповец (8202)49-02-64
Чита (3022)38-34-83
Якутск (4112)23-90-97
Ярославль (4852)69-52-93

Россия +7(495)268-04-70

Казахстан +7(7172)727-132

Киргизия +996(312)96-26-47

эл.почта: tam@nt-rt.ru || сайт: <https://3m.nt-rt.ru/>